



PRODUCT SPECIFICATION

Part Number

PT322457F-TLMWU-EMR03

CUSTOMER	
CUSTOMER PART NUMBER	
DESCRIPTION	5.7" TFT LCD, Medium Bright
APPROVED BY	
DATE	

**1. Table of Contents**

No.	Contents	Page
1	Table of Contents	2
2	Record of Revisions	3
3	Module Numbering System	4
4	Application	5
5	Features	5
6	General Specifications	5
7	Absolute Maximum Ratings	6
8	Electrical Characteristics	7
9	Block Diagram	10
10	Input / Output Terminals Pin Assignment	11
11	Interface Timing	14
12	Optical Characteristics	16
13	Reliability Test	19
14	Packaging	20
15	Precautions	21
16	Outline Drawing	23
17	Definition of Labels	24
18	Incoming Inspection Standards	26



3. Module Numbering System

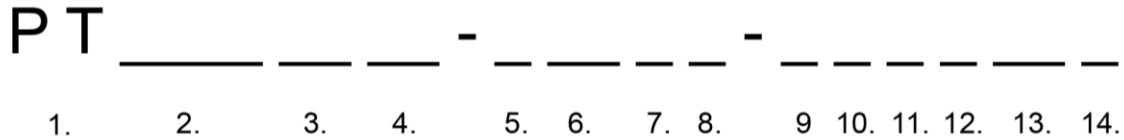

1. P-TEC TFT

8. VIEWING DIRECTION

D: 6 o'clock
U: 12 o'clock
F: Full Viewing Angle

2. LENGTH x WIDTH PIXELS

If third character is a zero, it is removed to shorten part number. Example: 240 x 320 = PT3224

9. A ~ Z CODE

Assigned by P-tec

3. DIAGONAL DIMENSIONS

Example: 3.5" display = 35 in part number

11. TEMPERATURE RANGE

Normal: Left Blank
Wide: X

4. PRODUCT VERSION

Series assigned by P-tec

12. LUMINANCE

Blank: Normal (<300 nit)
M: Middle (>= 300 nit)
H: High (> 600 nit)

5. LCD MODE

T: TN
I: IPS
V: VA

13. TOUCH PANEL OPTION

No TP: Left Blank
C: Capacitive TP
R: Resistive TP

6. POLARIZER

LM: Transmissive
LF: Transflective

14. SPECIAL CHARACTERS

Customer special requirements

7. BACKLIGHT COLOR

No Backlight: Left Blank
W: White
B: Blue/Green
S: Yellow/Green



4. Application

This specification is applied to the 5.7 inch QVGA supported TFT-LCD module, and can display true 262,144 colors(6 bit/ color). The module is designed for OA, Car TV application and other electronic products which require flat panel display of digital signal interface. This module is composed of a 5.7”TFT-LCD panel, a driver circuit and LED backlight unit and used as the input devices for general electric appliances via both finger and pen-entry.

5. Features

- QVGA (320x240 pixels) resolution.
- Digital 18 bit parallel RGB.
- Line inversion mode with stripe type.
- Both DE mode and SYNC mode are supported for digital RGB input data format.
- Transparent Touch panel
 - 4-Wire
 - Analog Resistive

6. General Specifications

Item	Specifications	Unit
Screen Size	5.7 (Diagonal)	inch
Display Format	320RGB(H)x240(V)	dot
Active Area	115.2(H)x86.4(V)	mm
Dot Size	0.120(H)x0.360(V)	mm
Pixel Configuration	RGB Vertical Stripe	-
Display Mode	TN Type Transmissive Mode Normally White	-
Surface Treatment	Anti-Glare	-
Viewing Direction	12 O'clock (The Gray Inversion will appear at this direction)	-
Outline Dimension	144.0(W)x104.6(H)x14.5(D)	mm
Weight	(250)	g



7. Absolute Maximum Ratings

7.1 Absolute Ratings of Environment

Item	Symbol	Value		Unit	Note
		Min.	Max.		
Storage Temperature	T _{ST}	-30	+80	°C	(1)
Operating Ambient Temperature	T _{OP}	-20	+70	°C	(1)

Note (1) Temperature and relative humidity range are shown in the figure below.

(a) 90%RH Max. ($T_a \leq 40^\circ\text{C}$).

(b) Wet-bulb temperature should be 39°C Max. ($T_a > 40^\circ\text{C}$).

(c) No condensation.

7.2 Electrical Absolute Ratings

7.2.1 TFT-LCD Module

($T_a = 25 \pm 2^\circ\text{C}$, GND=VSS=0V)

Item	Symbol	Value		Unit	Note
		Min.	Max.		
Digital Power Supply Voltage	VCC	-0.3	4.3	V	-

7.2.2 Backlight Unit

($T_a = 25 \pm 2^\circ\text{C}$)

Item	Symbol	Value		Unit	Note
		Min.	Max.		
Current of Backlight Unit	I _B	-	75	mA	(1)
Voltage of Backlight Unit	V _B	-	30	V	(1)

Note (1) Permanent damage to the device may occur if maximum values are exceeded or reverse voltage is loaded.

**8. Electrical Characteristics****8.1 TFT-LCD Module**

(Ta=25±2°C)

Item	Symbol	Value			Unit	Note
		Min.	Typ.	Max.		
Power Supply Voltage	VCC	3.0	3.3	3.6	V	-
Input High Threshold Voltage	VIH	0.7VCC	-	VCC	V	-
Input Low Threshold Voltage	VIL	0	-	0.3VCC	V	-
Power Consumption	PL		(0.24)		W	(1)
Frame Frequency	Fv	-	60	-	Hz	-
Dot Clock	DCLK	-	6.4	7	MHz	-

Note (1) The specified power consumption is under the conditions at VCC=3.3V, Fv=60Hz, whereas a power dissipation check pattern below is displayed.

Black Pattern / 0 Gray

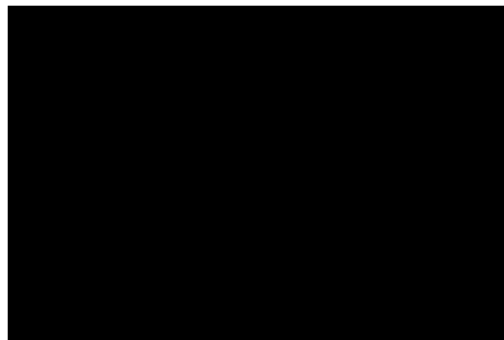

Active Area

8.2 Backlight Unit

(Ta=25±2°C)

Item	Symbol	Value			Unit	Note
		Min.	Typ.	Max.		
Current of Backlight Unit	IB	-	60	-	mA	-
Voltage of Backlight Unit	VB	-	23.1	-	V	IB =60mA
Power Consumption	PBL	-	(1.4)	-	W	IB =60mA
LED Life Time(25°C)		40000	--	--	hr	(1)

Note (1) : Lamp life time is defined as under 25±2°C , when the average brightness decrease to 50% of original brightness



8.3 Transparent Touch panel

Electrical characteristics

Item		Value			Unit	Note
		Min.	Typ.	Max.		
Operating Voltage		-	5	7	V	-
Terminal Resistance	X-direction	270	470	600	Ω	At connector
	Y-direction	240	310	500	Ω	At connector
Insulation Resistance		$\geq 20M\Omega$				At DC25V
Linearity		$\leq 1.5\%$				(1)
Chatting		≤ 10 ms				At connector

Note(1): How to measure the linearity

Definition of linearity :

In Fig. 1, when the DC 5V is applied to the "X" directional electrode and "Y" directional electrode of panel alternately, the voltage between the depressed point and the reference surface shall be the output voltage in X and Y surface (E_{ox} and E_{oy}). As shown in Fig. 2, measure the point on 10mm grid enclosed by the positions "A" and "B", which are located at the inside of visible area the specified distance away from the edge, has been depressed.

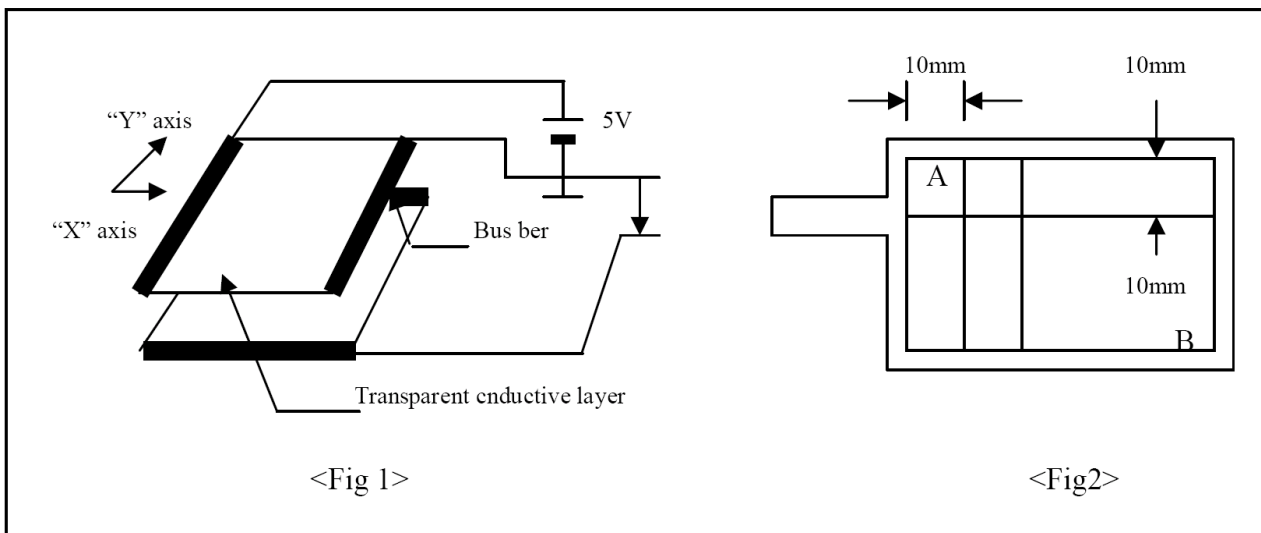

When the output voltage corresponding to every measurement position is plotted as shown in Fig. 3, the difference between the voltage enclosed by the positions "A" and "B" and the output voltage at the same position shall be " ΔE_x " (or " ΔE_y ") and the electric potential difference E_{AB} in X surface, " E_{ABx} " (or E_{AB} in Y surface, " E_{ABy} ") between "A" and "B" shall be defined as the linearity.



Linearity of transparent table (X) = $(\Delta E_x / E_{ABx}) \times 100\%$

Linearity of transparent table (Y) = $(\Delta E_y / E_{ABy}) \times 100\%$

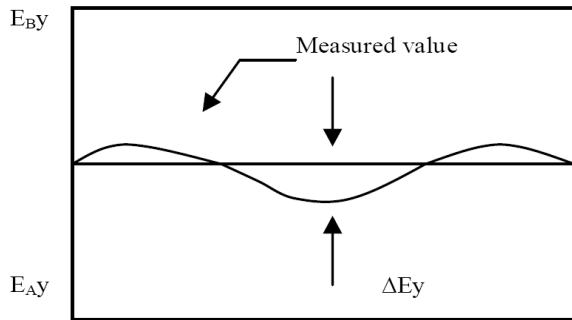

Measuring position

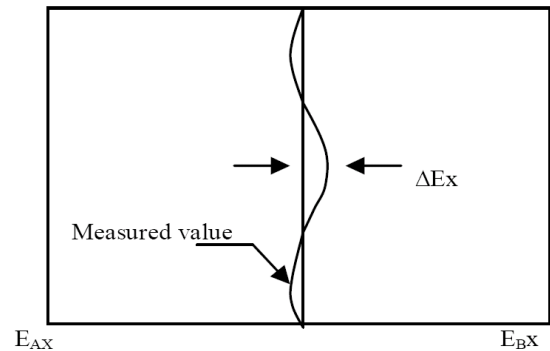

Measuring position

<Fig 3>

Measurement of linearity

A measured value shall be a maximum value in absolute value tolerance when every nodal point on a grid shown in Fig. 5 has been pressed under wiring conditions described in Fig. 4.

<Hitting conditions>

Load : 70 ~ 100g with R0.8 mm polyacetal stylus pen

Measuring area : 1.0mm inside the edge of touch panel active area

<Measuring circuit>

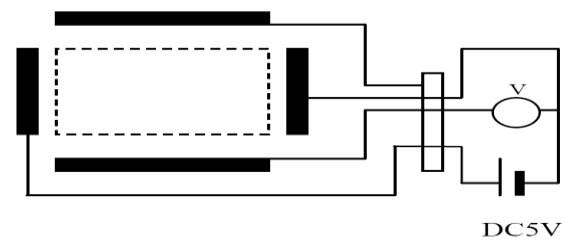
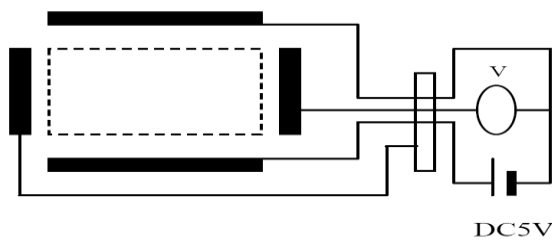

<Fig 4>

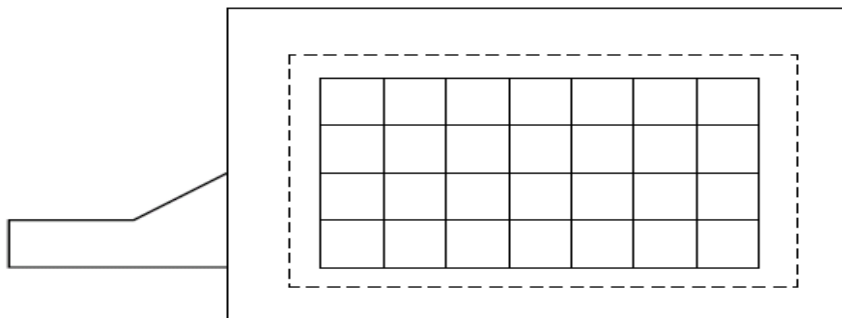

<Fig 5>



9. Block Diagram

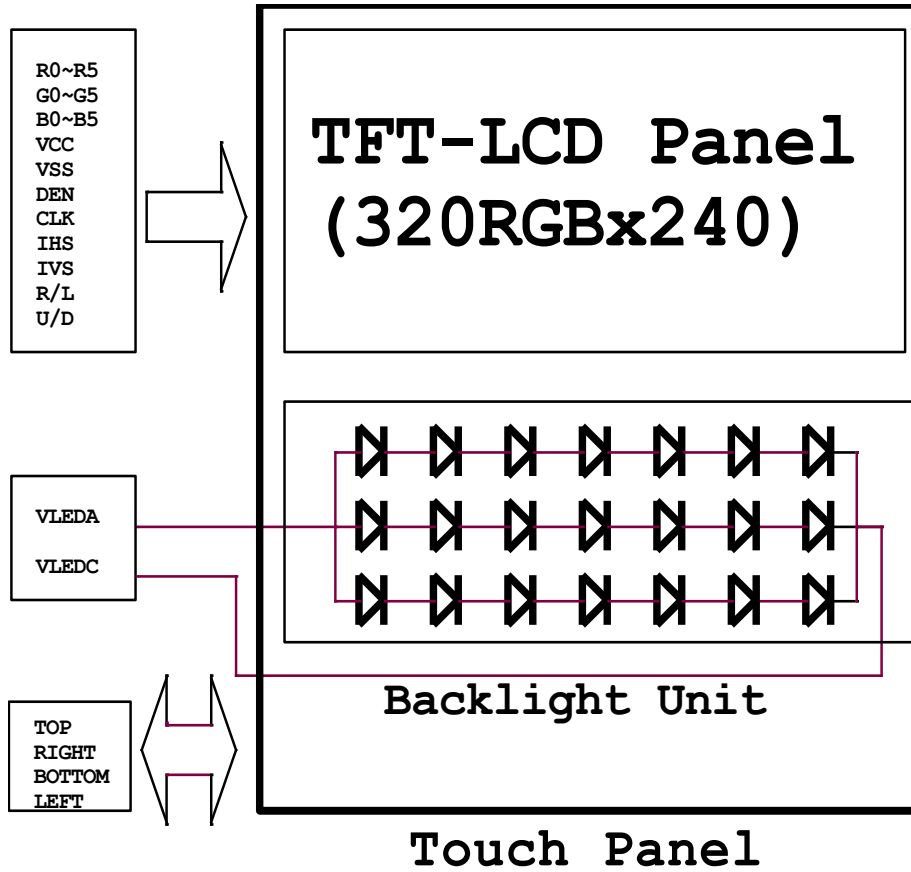



10. Input / Output Terminals Pin Assignment

10.1 TFT-LCD Module

Connector: CVILUX CF25331D0R0-05

Pin No.	Symbol	I/O	Description
1	VSS	I	Ground
2	CLK	I	Clock signal
3	IHS	I	Horizontal synchronous signal
4	IVS	I	Vertical synchronous signal
5	VSS	I	Ground
6	R0	I	RED data (LSB)
7	R1	I	RED data
8	R2	I	RED data
9	R3	I	RED data
10	R4	I	RED data
11	R5	I	RED data(MSB)
12	VSS	I	Ground
13	G0	I	GREEN data(LSB)
14	G1	I	GREEN data
15	G2	I	GREEN data
16	G3	I	GREEN data
17	G4	I	GREEN data
18	G5	I	GREEN data(MSB)
19	VSS	I	Ground
20	B0	I	Blue data(LSB)
21	B1	I	Blue data
22	B2	I	Blue data
23	B3	I	Blue data
24	B4	I	Blue data
25	B5	I	Blue data(MSB)
26	VSS	I	Ground
27	DEN	I	Input data enable control
28	VCC	I	+3.3V power supply
29	VCC	I	+3.3V power supply
30	R/L	I	Right-and-Left scan setting. ("L" : Normally , "H" : Right-and-Left reversal)



Pin No.	Symbol	I/O	Description
31	U/D	I	Up/down scan setting. ("H": normal scan. "L": Up-and-Down reversal.)
32	NC	I	No connection
33	VSS	I	Ground

10.2 Backlight Unit

Connector: JST BHSR-02VS-1(N)

Pin No.	Symbol	I/O	Description	Wire Color
1	VLEDA	I	Backlight LED Anode.	Red
2	VLEDC	I	Backlight LED Cathode.	Black

10.3 Transparent Touch Panel

Connector: CVILUX CF25041D0R0-10

Pin No.	Symbol
1	TOP
2	RIGHT
3	BOTTOM
4	LEFT



10.4 Color Data Input Assignment

The brightness of each primary color(red, green and blue) is based on the 6 bit gray scale data input for the color. The higher the binary input, the brighter the color. The table provides the assignment of color versus data input.

Color		Data Signal																	
		Red						Green						Blue					
		D05	D04	D03	D02	D01	D00	D15	D14	D13	D12	D11	D10	D25	D24	D23	D22	D21	D20
Basic Colors	Black	0	0	0	0	0	0	0	0	0	0	0	0	0	0	0	0	0	0
	Red	1	1	1	1	1	1	0	0	0	0	0	0	0	0	0	0	0	0
	Green	0	0	0	0	0	0	1	1	1	1	1	1	0	0	0	0	0	0
	Blue	0	0	0	0	0	0	0	0	0	0	0	0	1	1	1	1	1	1
	Cyan	0	0	0	0	0	0	1	1	1	1	1	1	1	1	1	1	1	1
	Magenta	1	1	1	1	1	1	0	0	0	0	0	0	0	0	0	0	0	0
	Yellow	1	1	1	1	1	1	1	1	1	1	1	1	0	0	0	0	0	0
	White	1	1	1	1	1	1	1	1	1	1	1	1	1	1	1	1	1	1
Gray Scale Of RED	Red(0) / Dark	0	0	0	0	0	0	0	0	0	0	0	0	0	0	0	0	0	0
	Red(1)	0	0	0	0	0	1	0	0	0	0	0	0	0	0	0	0	0	0
	Red(2)	0	0	0	0	1	0	0	0	0	0	0	0	0	0	0	0	0	0
	:	:	:	:	:	:	:	:	:	:	:	:	:	:	:	:	:	:	:
	:	:	:	:	:	:	:	:	:	:	:	:	:	:	:	:	:	:	:
	Red(61)	1	1	1	1	0	1	0	0	0	0	0	0	0	0	0	0	0	0
	Red(62)	1	1	1	1	1	0	0	0	0	0	0	0	0	0	0	0	0	0
	Red(63)	1	1	1	1	1	1	0	0	0	0	0	0	0	0	0	0	0	0
Gray Scale Of Green	Green(0) / Dark	0	0	0	0	0	0	0	0	0	0	0	0	0	0	0	0	0	0
	Green(1)	0	0	0	0	0	0	0	0	0	0	0	1	0	0	0	0	0	0
	Green(2)	0	0	0	0	0	0	0	0	0	0	1	0	0	0	0	0	0	0
	:	:	:	:	:	:	:	:	:	:	:	:	:	:	:	:	:	:	:
	:	:	:	:	:	:	:	:	:	:	:	:	:	:	:	:	:	:	:
	Green(61)	0	0	0	0	0	0	1	1	1	1	0	1	0	0	0	0	0	0
	Green(62)	0	0	0	0	0	0	1	1	1	1	1	0	0	0	0	0	0	0
	Green(63)	0	0	0	0	0	0	1	1	1	1	1	1	0	0	0	0	0	0
Gray Scale Of Blue	Blue(0) / Dark	0	0	0	0	0	0	0	0	0	0	0	0	0	0	0	0	0	0
	Blue(1)	0	0	0	0	0	0	0	0	0	0	0	0	0	0	0	0	0	1
	Blue(2)	0	0	0	0	0	0	0	0	0	0	0	0	0	0	0	0	0	1
	:	:	:	:	:	:	:	:	:	:	:	:	:	:	:	:	:	:	:
	:	:	:	:	:	:	:	:	:	:	:	:	:	:	:	:	:	:	:
	Blue(61)	0	0	0	0	0	0	0	0	0	0	0	0	1	1	1	1	0	1
	Blue(62)	0	0	0	0	0	0	0	0	0	0	0	0	1	1	1	1	1	0
	Blue(63)	0	0	0	0	0	0	0	0	0	0	0	0	1	1	1	1	1	1

**11. Interface Timing****11.1 Input Signal Characteristics**

PARAMETER		Symbol	Min.	Typ.	Max.	Unit
CLK period		T_{OSC}	-	156	-	ns
Data setup time		T_{SU}	12	-	-	ns
Data hold time		T_{HD}	12	-	-	ns
IHS period		T_H	-	408	-	T_{OSC}
IHS pulse width		T_{HS}	5	30	-	T_{OSC}
IHS setup time		T_{Cr}	12	-	-	ns
IHS hold time		T_{Cf}	12	-	-	ns
IVS pulse width		T_{VS}	1	3	5	T_H
IVS setup time		T_{Vr}	12	-	-	ns
IVS hold time		T_{Vf}	12	-	-	μ s
IVS-DEN time	NTSC	T_{VSE}	-	18	-	T_H
	PAL	T_{VSE}	-	26	-	T_H
IHS-DEN time		T_{HE}	36	68	88	T_{OSC}
DEN pulse width		T_{EP}	-	320	-	T_{OSC}
DEN-STH time		T_{DES}	-	1	-	T_{OSC}
IVS period	NTSC	-	-	262.5	-	T_H
	PAL	-	-	312.5	-	T_H

Note: When SYNC mode is used, 1st data start from 68th CLK after IHS falling.



11.2 Waveform

11.2.1 Clock and Data Waveform

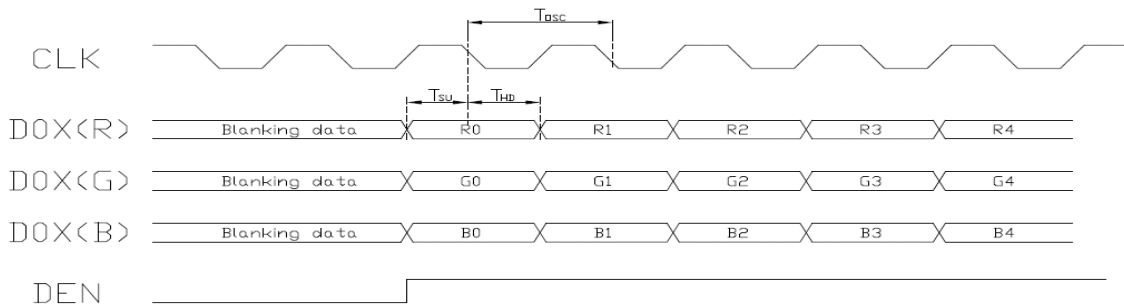

11.2.2 Clock and Sync waveforms

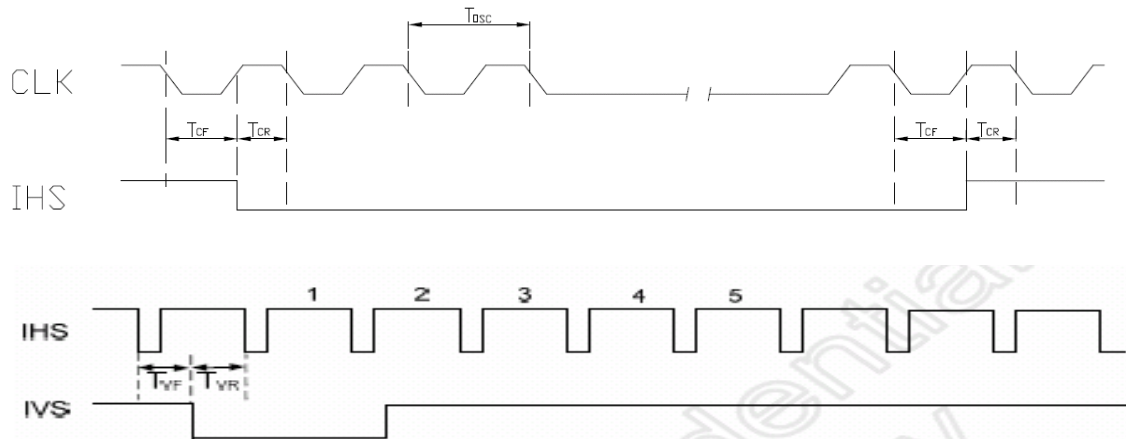

11.2.3 IHS and horizontal control timing waveforms

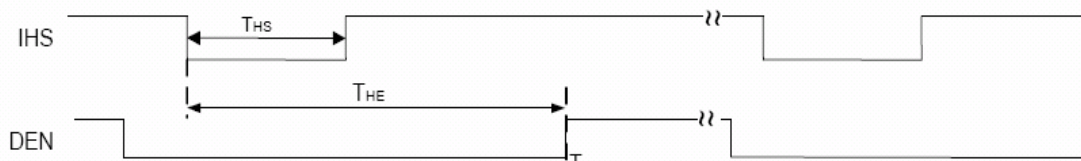

11.2.4 IHS and vertical control timing waveforms

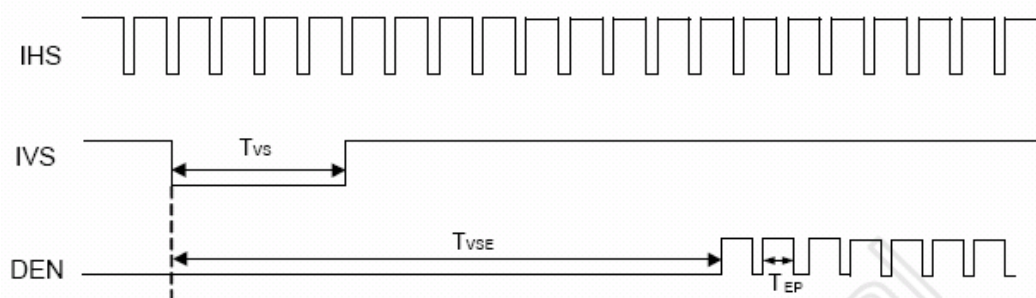



12. Optical Characteristics

The optical characteristics should be measured in a dark environment (≤ 1 lux) or equivalent state with the methods shown in Note (4).

Item		Symbol	Conditions	Min.	Typ.	Max.	Unit	Note
Contrast Ratio		CR	$\theta_x=0^\circ, \theta_y=0^\circ$ Viewing Normal Angle	300	(350)	-	-	(2)
Response Time		T_R		-	15	-	ms	(3)
		T_F		-	35	-	ms	
Luminance(Center)		Y		300	(360)	-	cd/m ²	(4)
Brightness uniformity		BUNI		80	(85)	-	%	(5)
Color Chromaticity	Red	Rx		(0.581)	(0.631)	(0.681)	-	(1),(4)
		Ry		(0.297)	(0.347)	(0.397)	-	
	Green	Gx		(0.268)	(0.318)	(0.368)	-	
		Gy		(0.551)	(0.601)	(0.651)	-	
	Blue	Bx		(0.092)	(0.142)	(0.192)	-	
		By	(0.052)	(0.092)	(0.142)	-		
	White	Wx	(0.263)	(0.313)	(0.363)	-		
		Wy	(0.295)	(0.345)	(0.395)	-		
Viewing Angle	Horizontal	θ_{x+}	(55)	(60)	-	deg.		
		θ_{x-}	(55)	(60)	-			
	Vertical	θ_{y+}	(45)	(55)	-			
		θ_{y-}	(35)	(50)	-			



Note (1) Definition of Viewing Angle (θ_x , θ_y):

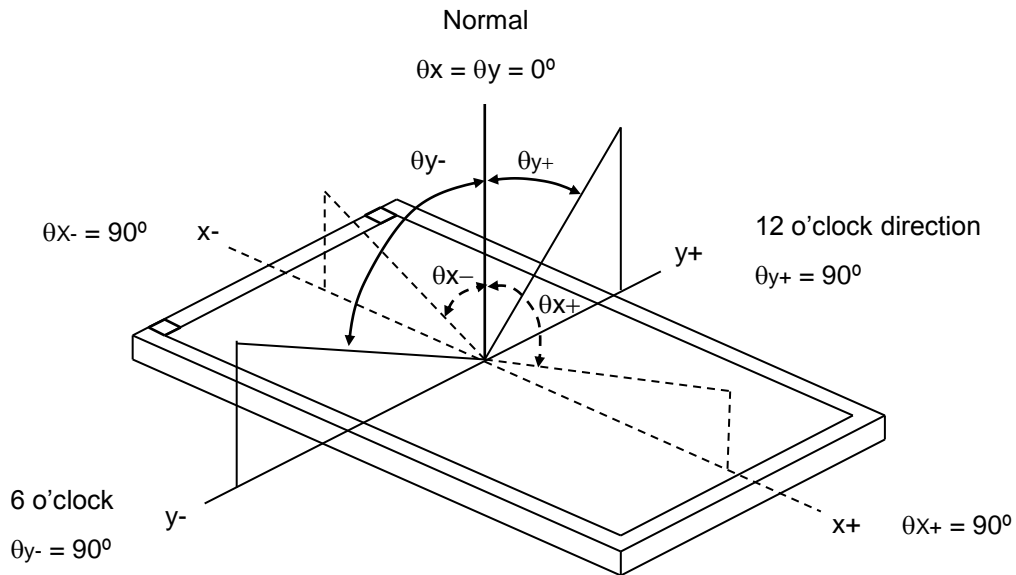

Note (2) Definition of Contrast Ratio (CR):

Measured at the center point of panel

$$\text{Contrast Ratio (CR)} = L_{255} / L_0$$

L255: Luminance of gray level 255

L 0: Luminance of gray level 0.

Note (3) Definition of Response Time (T_R , T_F):

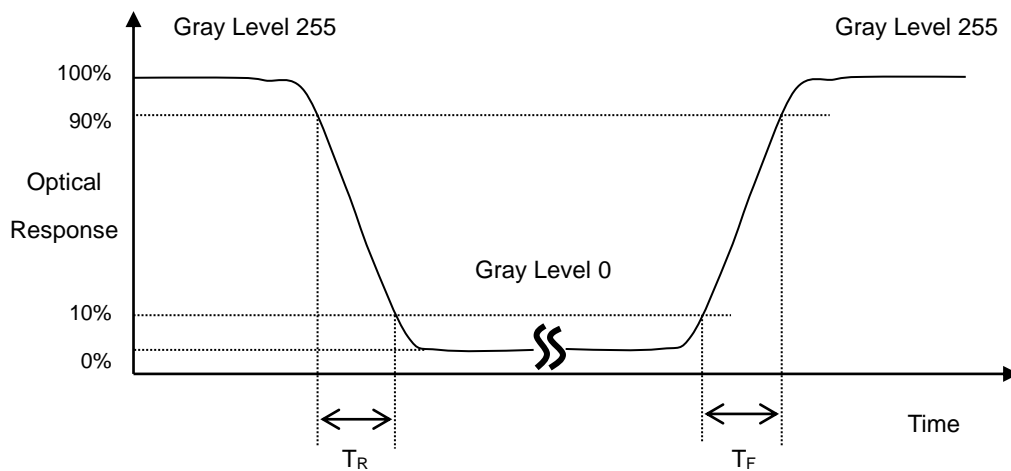



Note (4) Measurement Set-Up:

The LCD module should be stabilized at a given temperature for 30 minutes to avoid abrupt temperature change during measuring. In order to stabilize the luminance, the measurement should be executed after lighting Backlight for 30 minutes in a windless room.

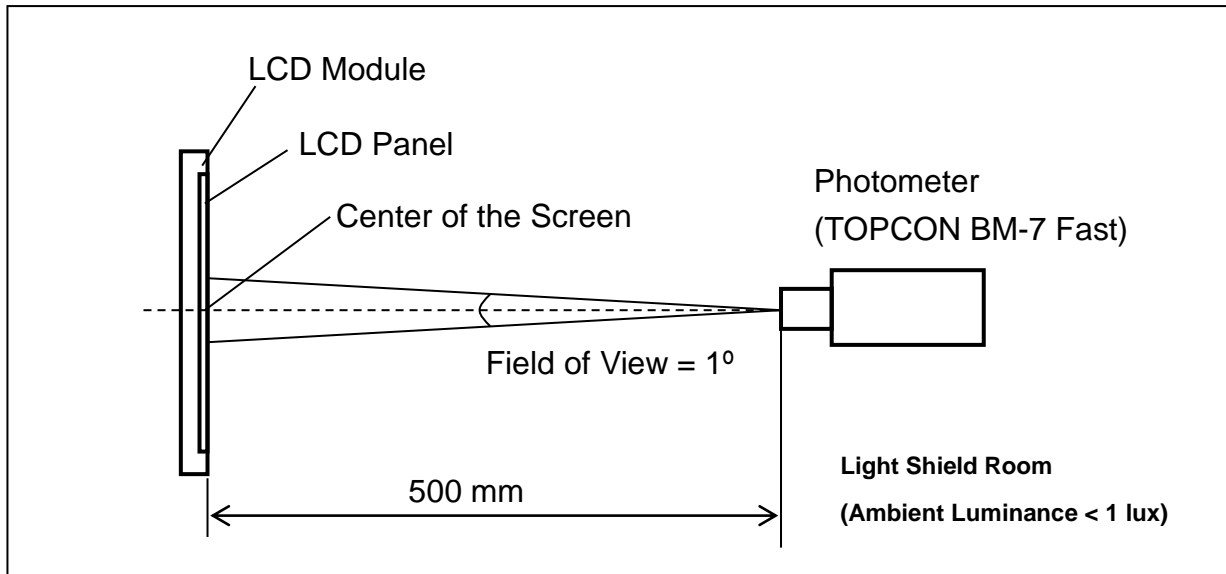

Note (5) Definition of brightness uniformity

Brightness uniformity=(Min Luminance of 9 points)/(Max Luminance of 9 points)×100%

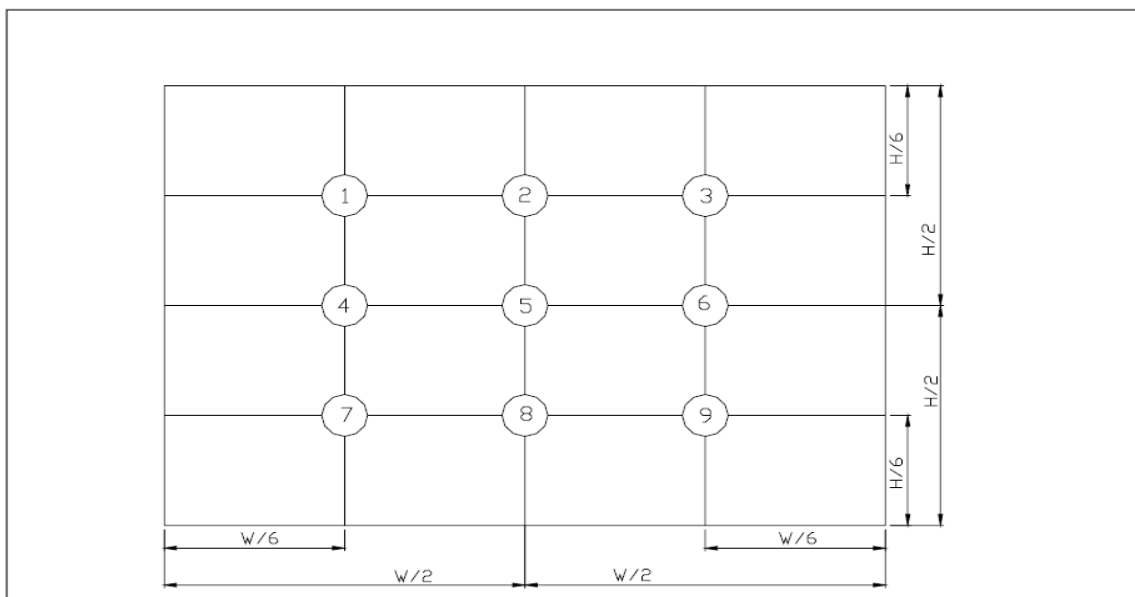

(單位 : mm)

**13. Reliability Test**

No.	Test Items	Test Condition	Remark
1	High Temperature Storage Test	T _a = 80°C 240 hours	-
2	Low Temperature Storage Test	T _a = -30°C 240 hours	-
3	High Temperature Operation Test	T _a = 70°C 240 hours	-
4	Low Temperature Operation Test	T _a = -20°C 240 hours	-
5	High Temperature and High Humidity Operation Test	T _a =60°C 90%RH 240 hours	-
6	Electro Static Discharge Test (non-operating)	-Panel Surface/Top Case : 150pF, 330Ω Air: ±15kV, Contact: ±8kV	-
7	Mechanical Shock Test (non-operating)	Half sine wave, 80G, 11ms 3 times shock of each six surfaces	-
8	Vibration Test (non-operating)	Sine wave, 10 ~ 55 ~ 10Hz, 3 axis, 2 hours/axis	-
9	Thermal Shock Test (non-operating)	-20°C(30min) ~ 70°C(30min), 100 cycles	-
10	Drop Test(with Carton)	Height: 80cm 1 corner, 3 edges, 6 surfaces	-



14. Packaging

Packing Method

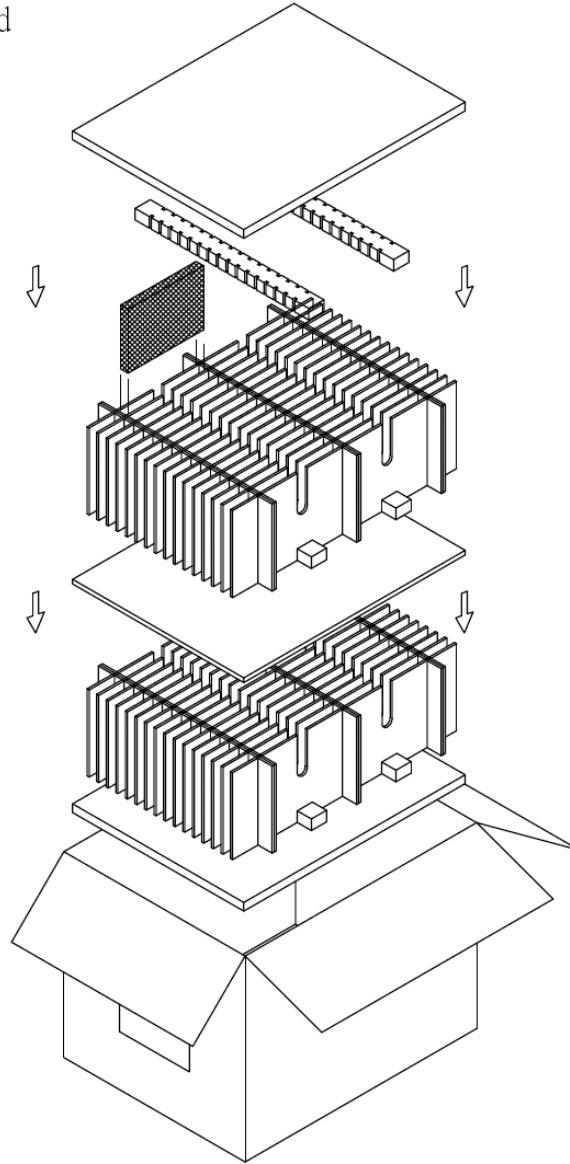

PARTS LIST					
	ITEM	SIZE(LxWxH) unit:mm	MATERIAL	Q.T.Y	NOTE
1	STATIC SHIEDING BAGS	200.0x145.0*0.09		60	
2	PU FOAM	440.0x340.0x15.0	SPONGE	2	
3	EPE PAD	345.0x30.0x20.0		8	
4	CARD BOARD	345.0x150.0(16ツ)	CARTON	12	
5	CARD BOARD	450.0x150.0(3ツ)	CARTON	32	
6	CARD BOARD	440.0x340.0x8.0	CARTON	1	
7	EXTERNAL BOX	460.0x360.0x355.0	CARTON	1	
8	PRODUCT	144.0x104.6x14.5		60	



15. Precautions

15.1 Assembly and Handling Precautions

- (1) Do not apply rough force such as bending or twisting to the module during assembly.
- (2) It's recommended to assemble or to install a module into the user's system in clean working areas. The dust and oil may cause electrical short or worsen the polarizer.
- (3) Don't apply pressure or impulse to the module to prevent the damage of LCD panel and Backlight.
- (4) Always follow the correct power-on sequence when the LCD module is turned on. This can prevent the damage and latch-up of the CMOS LSI chips.
- (5) Do not plug in or pull out the I/F connector while the module is in operation.
- (6) Do not disassemble the module.
- (7) Use a soft dry cloth without chemicals for cleaning, because the surface of polarizer is very soft and easily scratched.
- (8) Moisture can easily penetrate into LCD module and may cause the damage during operation.
- (9) High temperature or humidity may deteriorate the performance of LCD module. Please store LCD module in the specified storage conditions.
- (10) When ambient temperature is lower than 10°C, the display quality might be reduced. For example, the response time will become slow.

15.2 Safety Precautions

- (1) If the liquid crystal material leaks from the panel, it should be kept away from the eyes or mouth. In case of contact with hands, skin or clothes, it has to be washed away thoroughly with soap.
- (2) After the module's end of life, it is not harmful in case of normal operation and storage.



15.3 Cautions for installing and assembling

Bezel edge must be positioned in the area between the Active area and View area.

The bezel may press the touch screen and cause activation if the edge touches the active area. A gap of approximately 0.5mm is needed between the bezel and the top electrode.

It may cause unexpected activation if the gap is too narrow. There is a tolerance of 0.2 to 0.3mm for the outside dimensions of the touch panel and tail. A gap must be made to absorb the tolerance in the case and connector.

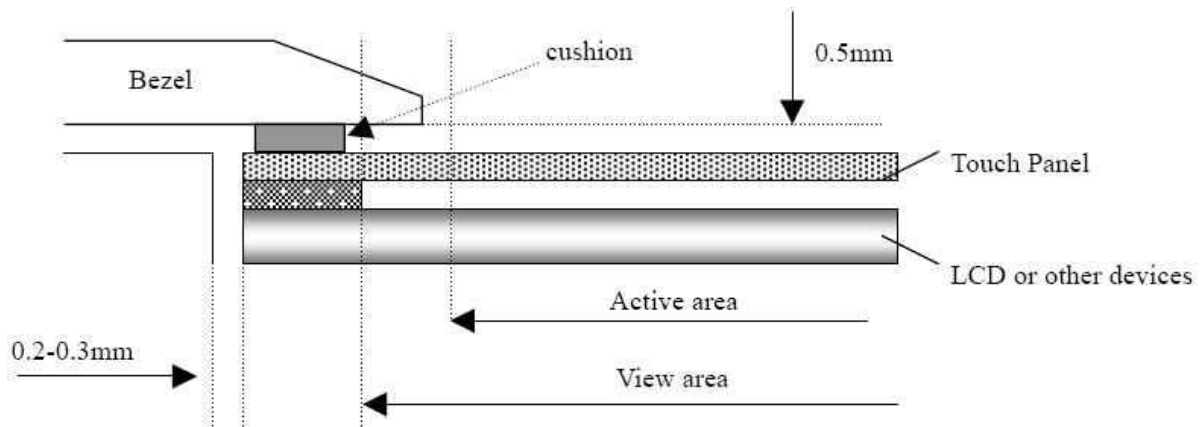



P-TEC

MODEL NO.

PT322457F-TLMWU-EMR03

SPEC SAMPLE

PAGE

23

16.Outline Drawing

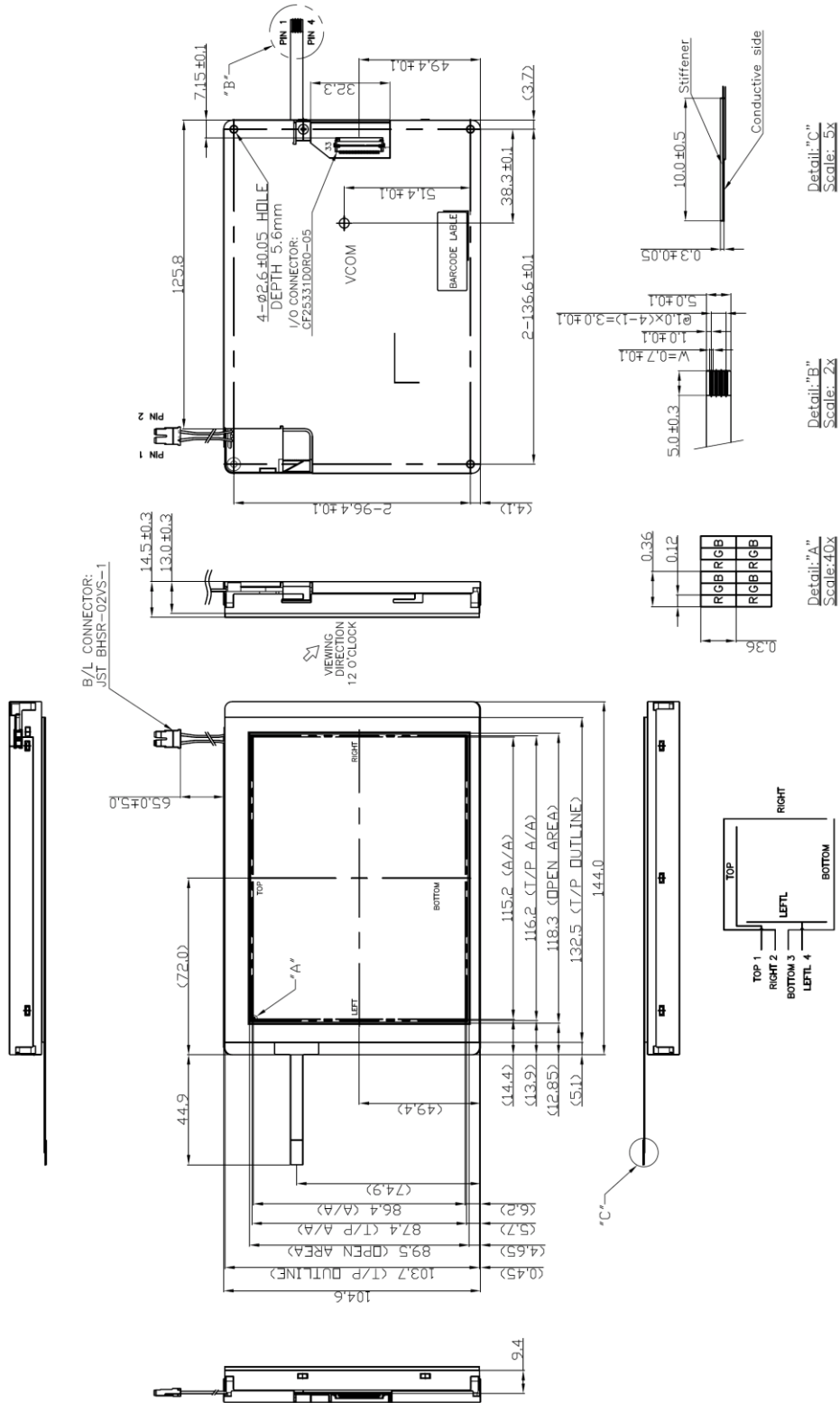



17. Definition of Labels

The bar code nameplate is pasted on each module as illustration, and its definitions are as following explanation.

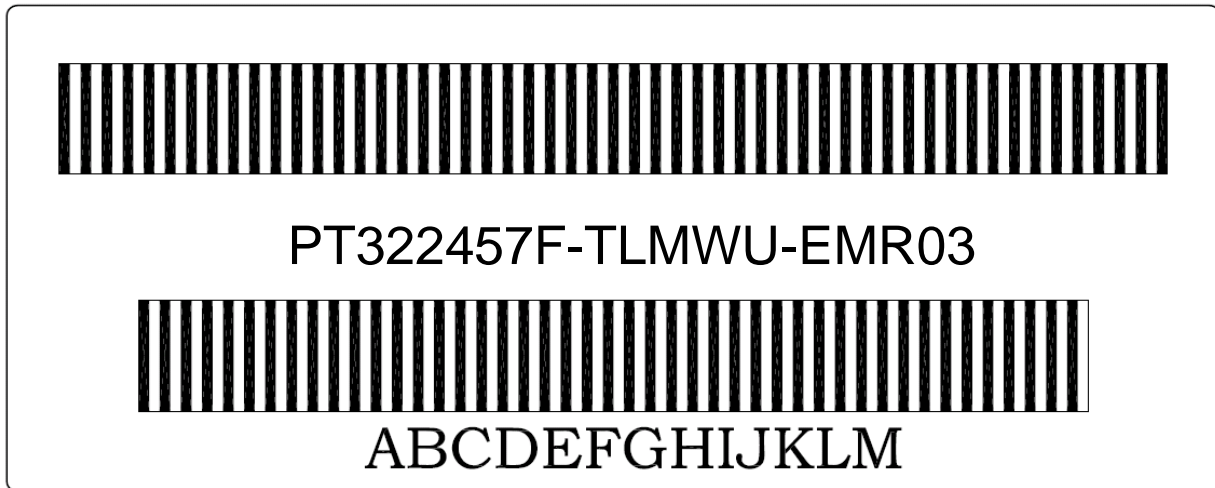

(a) Module Name: PT322457F-TLMWU-EMR03

(b) Serial ID:

A B C D E F G H I J K L M

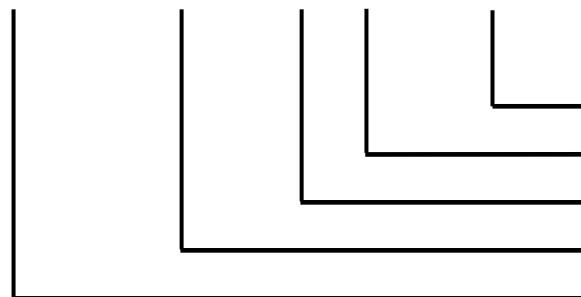

Serial No.
Revision Code
Factory Code
Manufactured Date
Screen Size

Serial ID includes the information as below:

(a) Screen size (Diagonal): Inch Code (ABCD)

3.5" → 0350

10.4" → 1040

(b) Manufactured Date: Year, Month, Day (EFG)

Year (E)

Year	2000	2001	2002	2003	2004	2005	2006	2007	2008	2009
Mark	0	1	2	3	4	5	6	7	8	9



Month (F)

Month	Jan.	Feb.	Mar.	Apr.	May	Jun.	Jul.	Aug.	Sep.	Oct.	Nov.	Dec.
Mark	1	2	3	4	5	6	7	8	9	A	B	C

Day (G)

Day	1	2	3	4	5	6	7	8	9	10	11	12	13	14	15	16
Mark	1	2	3	4	5	6	7	8	9	A	B	C	D	E	F	G
Day	17	18	19	20	21	22	23	24	25	26	27	28	29	30	31	
Mark	H	I	J	K	L	M	N	O	P	Q	R	S	T	U	V	

(c) Factory Code (H):

For P-TEC internal use.

(d) Revision Code (I):

Cover all the change, for example: 1: Rev.1, 2: Rev.2, 3: Rev.3...etc.

(e) Serial No. (JKLM):

Manufacturing sequence of product, for example: 0001~9999.



18. Incoming Inspection Standards

18.1 The environmental condition of inspection

The environmental condition and visual inspection shall be conducted as below.

- (1) Ambient temperature $25 \pm 5^{\circ}\text{C}$
- (2) Humidity: $60 \pm 5\% \text{ RH}$
- (3) Viewing distance is approximately 35 ~ 40 cm
- (4) Viewing angle is normal to the LCD panel as Fig _1(10°)
- (5) Ambient Illumination: 300 ~ 500 Lux for external appearance inspection

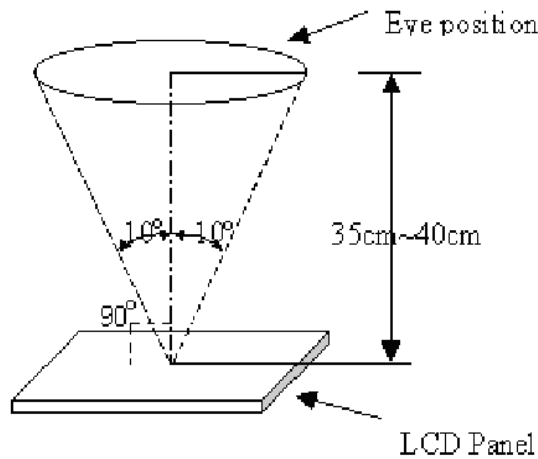

Fig _ 1

18.2 The defects classify of AQL as following:

Class of defects	AQL	Definition
Major	0.65%	It is defect that is likely to result in failure or to reduce materially the usability of the intended function.
Minor	1.5%	It is a defect that will not result in functioning problem with deviation classified.



18.3 Inspection Parameters

Item		Specification/Description			Note	
Display	Function	No Display			-	
		Malfunction			-	
Operating	Contrast ratio	Out of Spec			-	
	Line defect	No obvious Vertical and Horizontal line defect in bright , dark and colored.			-	
	Point Defect (red,green,blue,dark)	Item	Acceptable number			Note: 1、2、5、6、7
			A	B	Total	
		BRIGHT DOT	$N \leq 2$	$N \leq 2$	$N \leq 7$	
		DARK DOT	$N \leq 3$	$N \leq 4$		
		TOTAL DOT	$N \leq 4$	$N \leq 5$		
TWO ADJACENT DOT	NOT ALLOWED					
THREE OR MORE ADJACENT DOT	NOT ALLOWED					
External Inspection (non-operating)	Scratch on the polarizer	L(mm)	W(mm)	Acceptable number	Note:3	
		$L \leq 2.5$	$W \leq 0.1$	4		
		$L > 2.5$	$W > 0.1$	0		
	Scratch on the touch panel	L(mm)	W(mm)	Acceptable number	Note:3	
		$L \leq 5.0$	$W \leq 0.1$	3		
		$L > 5.0$	$W > 0.1$	0		
	Dent or bubble on the polarizer	Dimension(mm)	Acceptable number		Note:4	
		$D \leq 0.5$	4			
		$D \leq 0.15$	Disregard			
	Foreign material on the polarizer	Dimension(mm)	Acceptable number		Note:4	
$D \leq 0.5$		4				
$D \leq 0.15$		Disregard				



P-TEC

MODEL NO.

PT322457F-TLMWU-EMR03

SPEC SAMPLE

PAGE

28

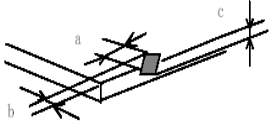
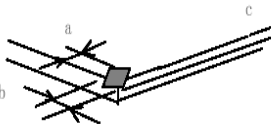
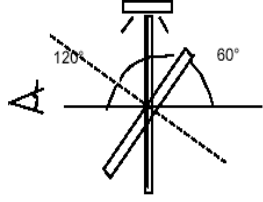
Item	Specification/Description		Note	
Touch Panel	Glass chipping		$a \leq 3\text{mm}$ $b \leq 3\text{mm}$ $c \leq t$ (t : Glass think)	Note:8
			$a \leq 3\text{mm}$ $b \leq 3\text{mm}$ $c \leq t$ (t : Glass think)	Note:8
Touch Panel	Newton-ring	(In case of doubtful situations) Observe on 60° from the product surface under a while Fluorescent lamp(3-wavelength lamp). 	Average diameter $\leq 7\text{mm}$ $N \leq 1$	Note:8

Note1. Distance between point defect distance should be large than 5 mm.

Note2. The definition of dot defect : The dot defect was judged after repair and the size of a defective dot over 1/2 of whole dot is regarded as one defective dot.

Note3.

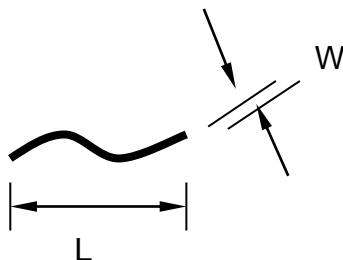

Note4. D : Diameter $D=(a+b)/2$

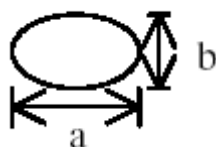



Note5. Bright dot is defined through 6% transmission ND Filter as following.

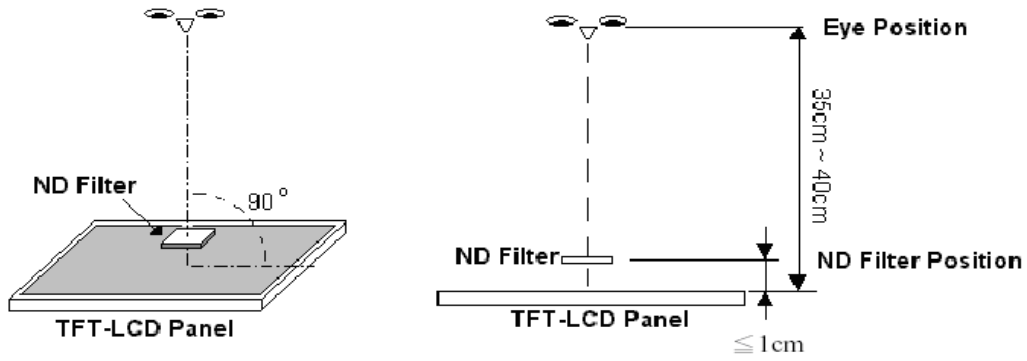

Note6. ADJACENT DOT



Note7.

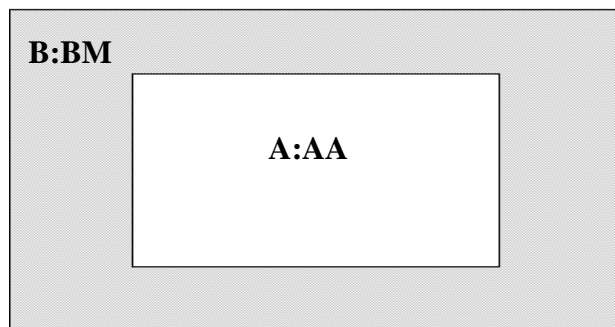



Note8.

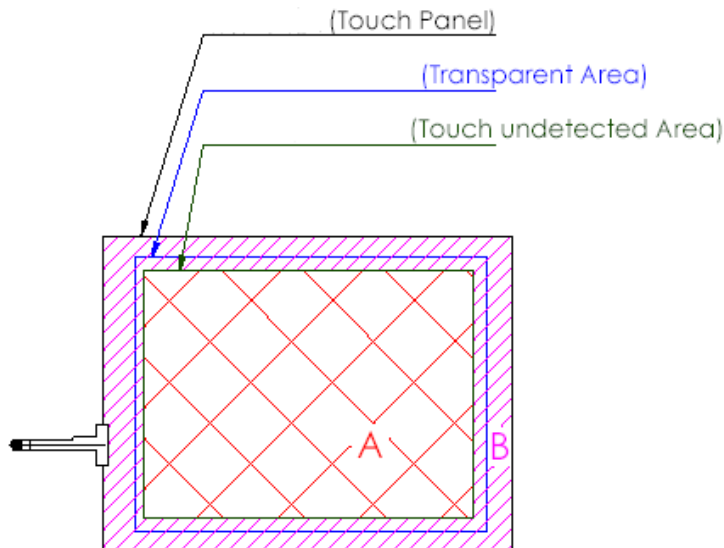

A area : Without any defect point effect on normal operation.

B area : None-specify

18.4 Handling of LCM

- (1) Don't give external shock.
- (2) Don't apply excessive force on the surface.
- (3) Liquid in LCD is hazardous substance. Must not lick and swallow. when the liquid is attach to your hand, skin, cloth etc. Wash it out thoroughly and immediately.
- (4) Don't operate it above the absolute maximum rating.
- (5) Don't disassemble the LCM.