



UM609A

LINEAR INTEGRATED CIRCUIT

DUAL OPERATIONAL AMPLIFIER AND CURRENT CONTROLLER

DESCRIPTION

The UTC **UM609A** is a monolithic IC that includes one independent op-amp and another op-amp for which the non inverting input is wired to a 2.5V fixed voltage reference. This device is offering space and cost saving in many applications like power supply management or switching battery chargers.

FEATURES

OPERATIONAL AMPLIFIER

- * Low supply current: 75uA/Per OP AMP.(@ $V_{CC}=5V$)
- * Medium bandwidth(unity gain): 1MHz
- * Large output voltage swing: $0V \sim (V_{CC}-1.5V)$
- * Wide power supply range: 3V~36V

VOLTAGE REFERENCE

- * Fixed output voltage reference 2.5V
- * Reference voltage tolerance
 - UM609A-1: $\pm 0.4\%$
 - UM609A-2: $\pm 1\%$
- * Sink current capability: 0.05~80mA
- * Typical output impedance: 0.2Ω

ORDERING INFORMATION

Ordering Number		Package	Packing
Lead Free	Halogen Free		
UM609AL-S08-R	UM609AG-S08-R	SOP-8	Tape Reel
UM609AL-SM1-R	UM609AG-SM1-R	MSOP-8	Tape Reel

<p>UM609AG-S08-R</p> <p>(1)Packing Type</p> <p>(2)Package Type</p> <p>(3)Green Package</p>	<p>(1) R: Tape Reel</p> <p>(2) S08: SOP-8, SM1: MSOP-8</p> <p>(3) G: Halogen Free and Lead Free, L: Lead Free</p>
--	---

MARKING

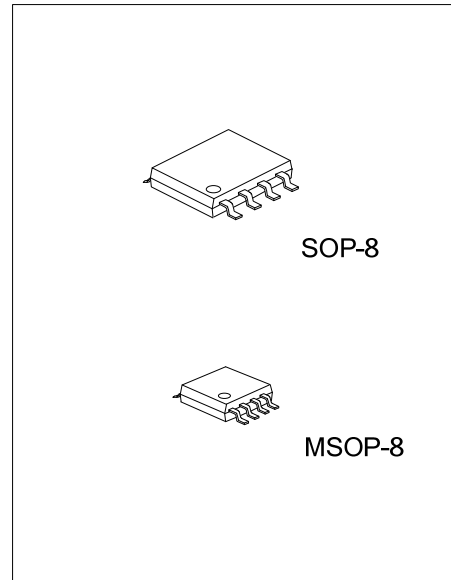
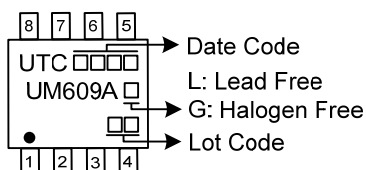

PIN CONFIGURATION

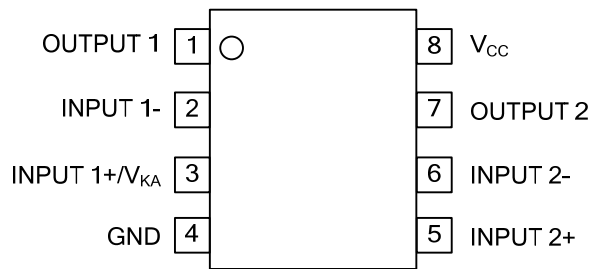

■ PIN DESCRIPTION

PIN NO.	PIN NAME	DESCRIPTION
1	OUTPUT 1	Output of Channel 1
2	INPUT 1-	Inverting Input of Channel 1
3	INPUT 1+ / V _{KA}	Non-Inverting Input of Channel 1 / Cathode of the Zener voltage
4	GND	Ground
5	INPUT 2+	Non-Inverting Input of Channel 2
6	INPUT 2-	Inverting Input of Channel 2
7	OUTPUT 2	Output of Channel 2
8	V _{CC}	Supply Voltage

■ BLOCK DIAGRAM

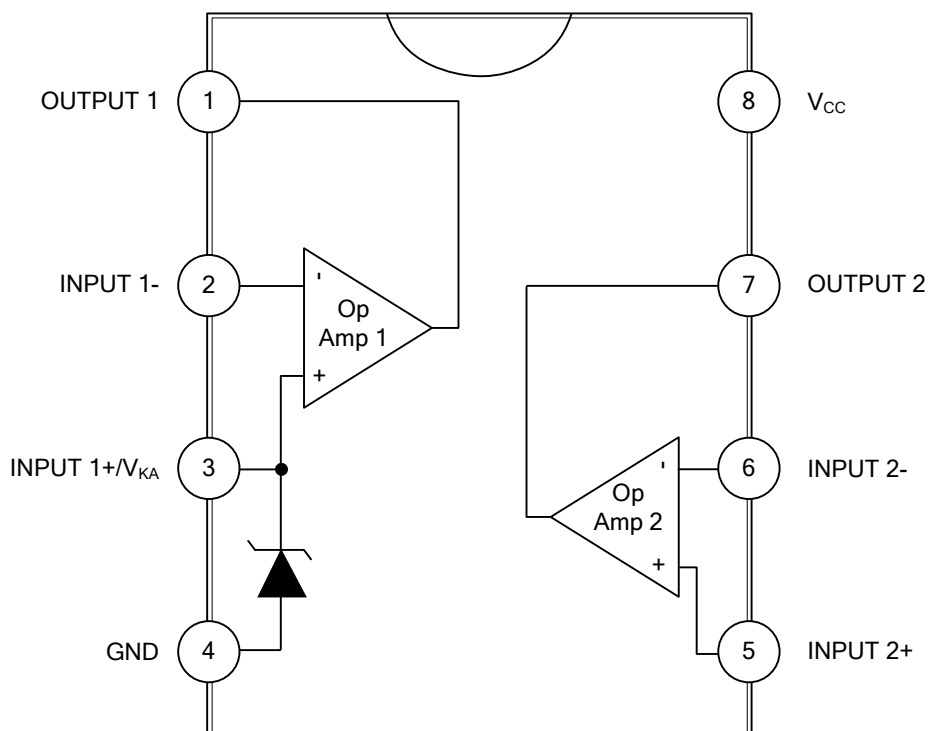

■ ABSOLUTE MAXIMUM RATING

PARAMETER	SYMBOL	RATINGS	UNIT
Power Supply Voltage (V_{CC} to GND)	V_{CC}	40	V
Op Amp 1 and 2 Input Voltage Range (Pins 2, 5, 6)	V_{IN}	-0.3~ $V_{CC}+0.3$	V
Op Amp 2 Input Differential Voltage (Pins 5, 6)	V_{ID}	40	V
Voltage Reference Cathode Current (Pin 3)	I_K	100	mA
Power Dissipation ($T_A=25^\circ\text{C}$)	SOP-8	500	mW
	MSOP-8	350	mW
Operating Junction Temperature	T_J	+150	$^\circ\text{C}$
Storage Temperature Range	T_{STG}	-65 ~ +150	$^\circ\text{C}$
Lead Temperature (Soldering 10s)	T_{LEAD}	260	$^\circ\text{C}$

Note: Absolute maximum ratings are those values beyond which the device could be permanently damaged. Absolute maximum ratings are stress ratings only and functional device operation is not implied.

■ RECOMMENDED OPERATING CONDITIONS

PARAMETER	SYMBOL	RATING	UNIT
Supply Voltage	V_{CC}	3 ~ 36	V
Ambient Temperature	T_A	-40 ~ +105	$^\circ\text{C}$

■ ELECTRICAL CHARACTERISTICS

(Operating Conditions: $V_{CC}=+5\text{V}$, $T_A=25^\circ\text{C}$ unless otherwise specified)

PARAMETER	SYMBOL	TEST CONDITIONS	MIN	TYP.	MAX	UNIT		
Total Supply Current, Excluding Current in Voltage Reference	I_{CC}	$V_{CC}=5\text{V}$, no load, $-40^\circ\text{C}\leq T_A\leq 105^\circ\text{C}$		0.17	0.25	mA		
		$V_{CC}=30\text{V}$, no load, $-40^\circ\text{C}\leq T_A\leq 105^\circ\text{C}$		0.24	0.30	mA		
Voltage Reference Section								
Reference voltage tolerance	UM609A-1	V_{REF}	$I_K=10\text{mA}$	$T_A=25^\circ\text{C}$	2.49	2.50	2.51	V
				$-40^\circ\text{C}\leq T_A\leq 105^\circ\text{C}$	2.48	2.50	2.52	V
	UM609A-2	$T_A=25^\circ\text{C}$	2.475	2.50	2.525	V		
		$-40^\circ\text{C}\leq T_A\leq 105^\circ\text{C}$	2.45	2.50	2.55	V		
Reference Voltage Deviation Over Full Temperature Range		$I_K=10\text{mA}$, $T_A=-40\sim 105^\circ\text{C}$		5	24	mV		
Minimum Cathode Current for Regulation				0.01	0.05	mA		
Dynamic Impedance		$I_K=1.0\sim 80\text{mA}$, $f<1\text{kHz}$		0.2	0.5	Ω		
Op Amp 1 Section ($V_{CC}=5\text{V}$, $V_O=1.4\text{V}$, $T_A=25^\circ\text{C}$, unless otherwise noted)								
Input Offset Voltage	$V_{i(OFF)}$	$T_A=25^\circ\text{C}$		0.5	3	mV		
		$T_A=-40\sim 105^\circ\text{C}$			5	mV		
Input Offset Voltage Temperature Drift	$DV_{i(OFF)}$	$T_A=-40\sim 105^\circ\text{C}$		7		$\mu\text{V}/^\circ\text{C}$		
Input Bias Current (Inverting Input Only)	$I_{I(BIAS)}$	$T_A=25^\circ\text{C}$		20	150	nA		
Large Signal Voltage Gain	A_{VD}	$V_{CC}=15\text{V}$, $R_L=2\text{k}\Omega$, $V_O=1.4\sim 11.4\text{V}$	85	100		dB		
Power Supply Rejection Ratio	PSRR	$V_{CC}=5\sim 30\text{V}$	70	95		dB		
Output Current	Source	I_{SOURCE}	$V_{CC}=15\text{V}$, $V_{ID}=1\text{V}$, $V_O=2\text{V}$	20	28	mA		
	Sink	I_{SINK}	$V_{CC}=15\text{V}$, $V_{ID}=-1\text{V}$, $V_O=2\text{V}$	7	12	mA		
Output Voltage Swing (High)	V_{OH}	$V_{CC}=30\text{V}$, $R_L=10\text{k}\Omega$, $V_{ID}=1\text{V}$	27	28		V		
Output Voltage Swing (Low)	V_{OL}	$V_{CC}=30\text{V}$, $R_L=10\text{k}\Omega$, $V_{ID}=-1\text{V}$		17	100	mV		
Slew Rate	SR	$V_{CC}=18\text{V}$, $R_L=2\text{k}\Omega$, $A_v=1$, $V_{IN}=0.5\sim 2\text{V}$, $C_L=100\text{pF}$	0.2	1.0		$\text{V}/\mu\text{s}$		
Unity Gain Bandwidth	GBP	$V_{CC}=30\text{V}$, $R_L=2\text{k}\Omega$, $C_L=100\text{pF}$	0.7	1.0		MHz		

■ ELECTRICAL CHARACTERISTICS (Cont.)

PARAMETER	SYMBOL	TEST CONDITIONS	MIN	TYP.	MAX	UNIT
Op Amp 2 Section ($V_{CC}=5V$, $V_O=1.4V$, $T_A=25^\circ C$, unless otherwise noted)						
Input Offset Voltage	$V_{I(OFF)}$	$T_A=25^\circ C$		0.5	3	mV
		$T_A=-40\sim 105^\circ C$			5	mV
Input Offset Voltage Temperature Drift	$DV_{I(OFF)}$	$T_A=-40\sim 105^\circ C$		7		$\mu V/^\circ C$
Input Offset Current	$I_{I(OFF)}$	$T_A=25^\circ C$		2	30	nA
Input Bias Current	$I_{I(BIAS)}$	$T_A=25^\circ C$		20	150	nA
Input Voltage Range	V_I	$V_{CC}=0\sim 36V$	0		$V_{CC}-1.5$	V
Common Mode Rejection Ratio	CMRR	$T_A=25^\circ C$, $V_{CM}=0\sim 3.5V$	70	85		dB
Large Signal Voltage Gain	AVD	$V_{CC}=15V$, $R_L=2k\Omega$, $V_O=1.4\sim 11.4V$	85	100		dB
Power Supply Rejection Ratio	PSRR	$V_{CC}=5\sim 30V$	70	95		dB
Output Current	Source	I_{SOURCE}	$V_{CC}=15V$, $V_{ID}=1V$, $V_O=2V$	20	28	mA
	Sink	I_{SINK}	$V_{CC}=15V$, $V_{ID}=-1V$, $V_O=2V$	7	12	mA
Output Voltage Swing (High)	V_{OH}	$V_{CC}=30V$, $R_L=10k\Omega$, $V_{ID}=1V$	27	28		V
Output Voltage Swing (Low)	V_{OL}	$V_{CC}=30V$, $R_L=10k\Omega$, $V_{ID}=-1V$		17	100	mV
Slew Rate	SR	$V_{CC}=18V$, $R_L=2k\Omega$, $A_V=1$, $V_{IN}=0.5\sim 2V$, $C_L=100pF$	0.2	1.0		$V/\mu s$
Unity Gain Bandwidth	GBP	$V_{CC}=30V$, $R_L=2k\Omega$, $C_L=100pF$	0.7	1.0		MHz

■ TYPICAL CHARACTERISTICS

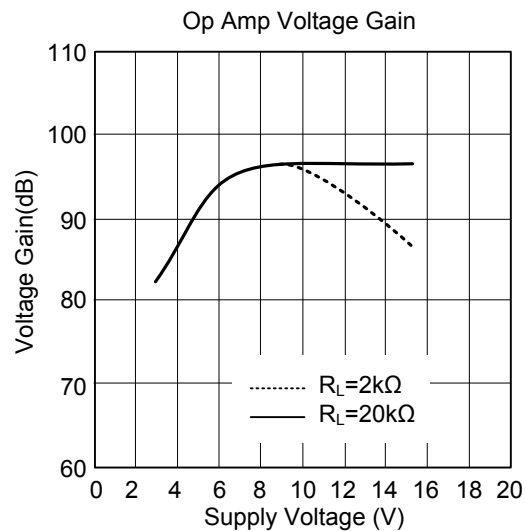
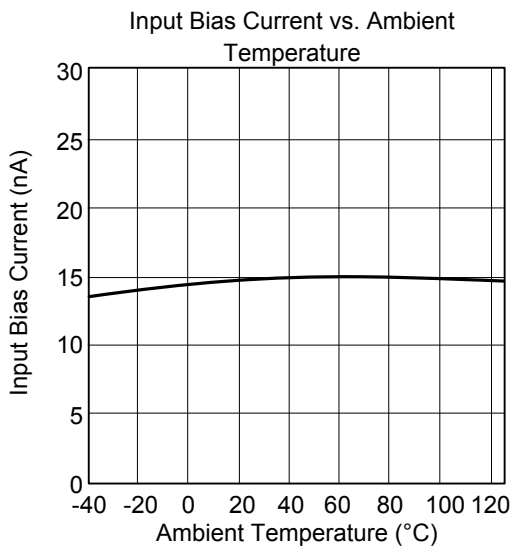
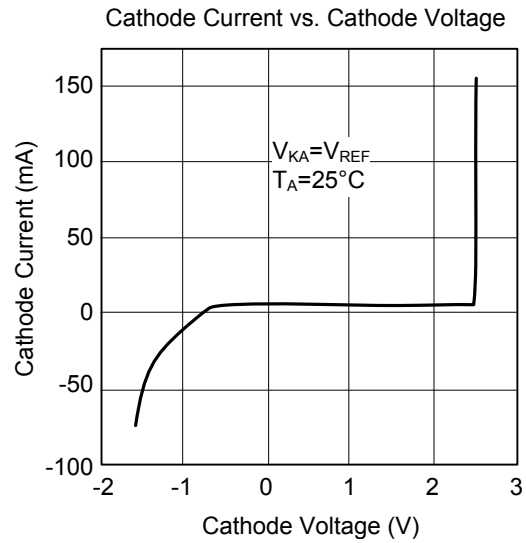
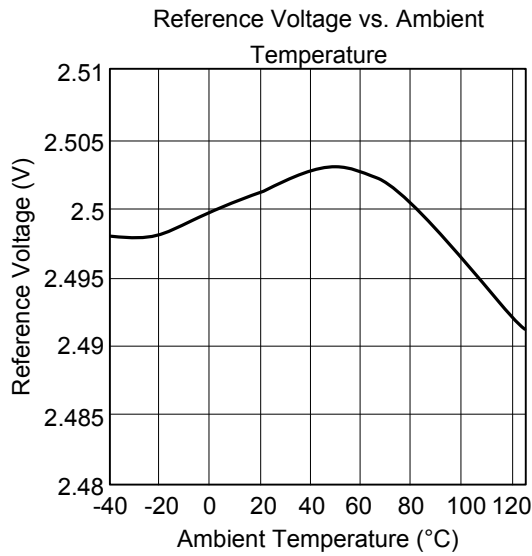

UTC assumes no responsibility for equipment failures that result from using products at values that exceed, even momentarily, rated values (such as maximum ratings, operating condition ranges, or other parameters) listed in products specifications of any and all UTC products described or contained herein. UTC products are not designed for use in life support appliances, devices or systems where malfunction of these products can be reasonably expected to result in personal injury. Reproduction in whole or in part is prohibited without the prior written consent of the copyright owner. The information presented in this document does not form part of any quotation or contract, is believed to be accurate and reliable and may be changed without notice.