

SPECIFICATION

Part No. : **TLS.01.305111**

Description : Shockwave 698-960/1575.42/1710-2700MHz
Permanent Mount External Antenna
3M CFD-200 SMA(M)

Features : Applicable for 2G/3G/4G cellular bands and GPS
Over 45% efficiency and 2.2 dBi gain
Mechanically robust for indoor/outdoor applications
Height: 79.45mm(3.13") ; Diameter : 42mm(1.65")
IP67 and IP69K Waterproof
Low loss CFD-200 cable, 3 meters
SMA(M) connector
RoHS compliant



1. Introduction

The Shockwave TLS.01.305111 is a permanent mount, waterproof, external 2G/3G/4G cellular and GPS antenna operating at 698-960/1575.42/1710-2700MHz with an N type male connector. It has been designed to be used on a Ground Plane. It can be used in mobile and fixed applications for 4G LTE wireless such as :

- Public safety
- HD Video Streaming
- Utilities and Smart Cities
- Fleet Management
- Agricultural
- Industrial

This antenna has superior performance over wide-bands compared to traditional whip antennas. Up to 77% efficiency and with a minimum 2.2dBi peak gain over all cellular bands result when mounted on a 30x30 cm ground plane. Stable radiation patterns over low angles provides consistent gain in the horizontal plane, meaning that it is especially suitable for cellular applications.

A unique indent tab on the base of the antenna allows a wrench to be used to solidly lock the antenna on top of its mounting location while tightening up the nut beneath the metal panel. Waterproof O-rings around the bottom base prevent water from leaking under the antenna.

The TLS.01 antenna is IP67 waterproof and IP69K resistant against high pressure water jets in commercial cleaning environments, which makes the antenna ideal for 2G/3G/4G applications either in indoor or in harsh outdoor environments.

2. Specification

ELECTRICAL								
Operation Band	LTE	GSM850	GSM900	GPS	DCS	PCS	WCDMA I	LTE
Operation Frequency (MHz)	698~806	824~896	880~960	1575.42	1710~1880	1850~1990	1920~2170	2300~2690
On 30 x 30 cm ground plane								
Efficiency (%)								
30cm Cable Length	94.23	95.11	80.92	67.29	77.21	80.27	78.56	67.79
1m Cable Length	89.16	90.83	77.28	62.80	70.42	73.21	72.37	61.82
2m Cable Length	83.21	83.50	70.48	55.97	62.76	64.59	63.50	53.51
3m Cable Length	77.02	77.31	65.31	51.04	55.77	57.19	56.04	46.50
5m Cable Length	66.52	65.80	55.17	42.46	44.05	44.84	43.61	35.10
Peak Gain (dBi)								
30cm Cable Length	3.22	3.32	3.15	2.08	3.90	3.82	3.73	4.64
1m Cable Length	3.02	3.12	2.95	1.78	3.50	3.42	3.33	4.24
2m Cable Length	2.72	2.82	2.55	1.28	3.00	2.92	2.73	3.64
3m Cable Length	2.42	2.42	2.25	0.88	2.50	2.32	2.23	3.02
5m Cable Length	1.72	1.72	1.55	0.08	1.50	1.32	1.13	1.82
Average Gain (dBi)								
30cm Cable Length	-0.26	-0.22	-0.93	-1.72	-1.13	-0.96	-1.05	-1.71
1m Cable Length	-0.50	-0.42	-1.13	-2.02	-1.53	-1.36	-1.41	-2.11
2m Cable Length	-0.80	-0.79	-1.53	-2.52	-2.03	-1.90	-1.98	-2.74
3m Cable Length	-1.14	-1.12	-1.86	-2.92	-2.54	-2.43	-2.52	-3.35
5m Cable Length	-1.77	-1.82	-2.59	-3.72	-3.57	-3.49	-3.61	-4.58
Return Loss (dB)*	<-8	<-10	<-10	<-10	<-10	<-10	<-10	<-10
Impedance	50 Ω							
Polarization	Vertical							
Radiation Property	Omni-Directional							
Max Input Power	100 W							

MECHANICAL	
Dimension (mm)	Height: 79.45mm(3.13") ; Diameter : 42mm(1.65")
Cable	3 meter CFD-200
Connector	SMA(M)
Material	Housing : UV Resistant ABS , Base : Nickel Plated Zinc Alloy
Weight (g)	270
Rec. Torque for Mounting	4.018 N.m
Max. Torque for Mounting	9.8 N.m
ENVIRONMENTAL	
Waterproof Rating	IP67 and IP69K
Operation Temperature	-40°C to 85°C
Humidity	Non-condensing 65°C 95% RH

*The data was measured with 3 meters cable length on a 30cm * 30cm ground plane.

3. Antenna Characteristics

3.1. Return Loss

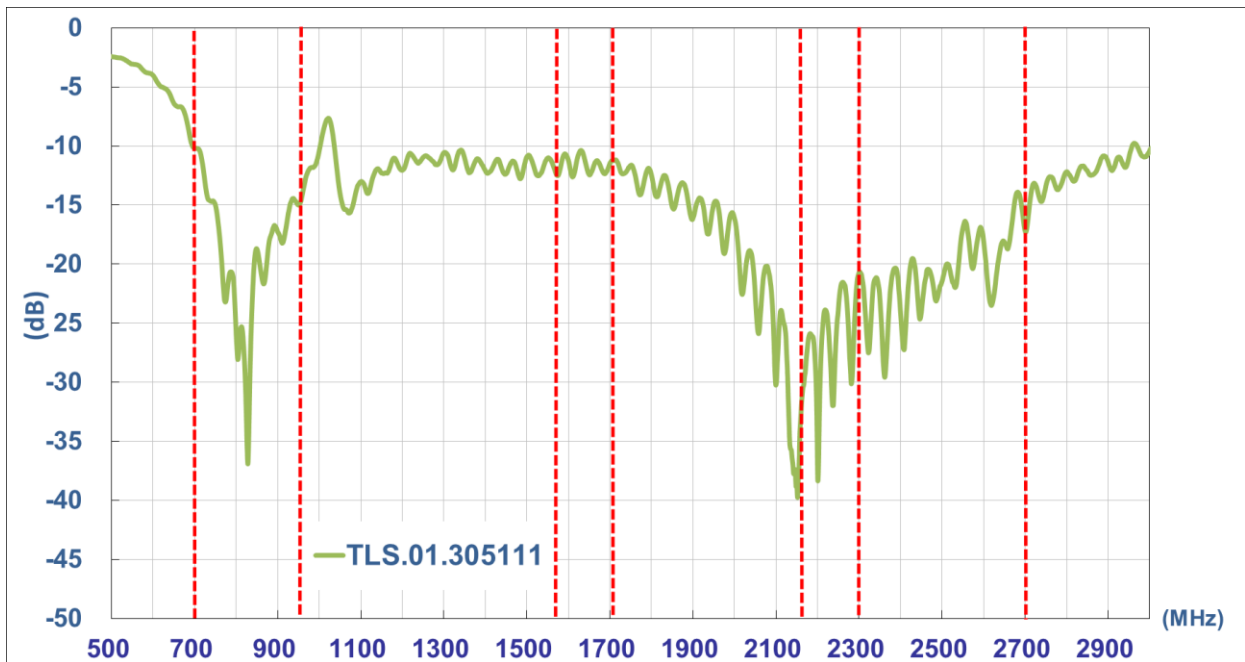

3.2. Efficiency

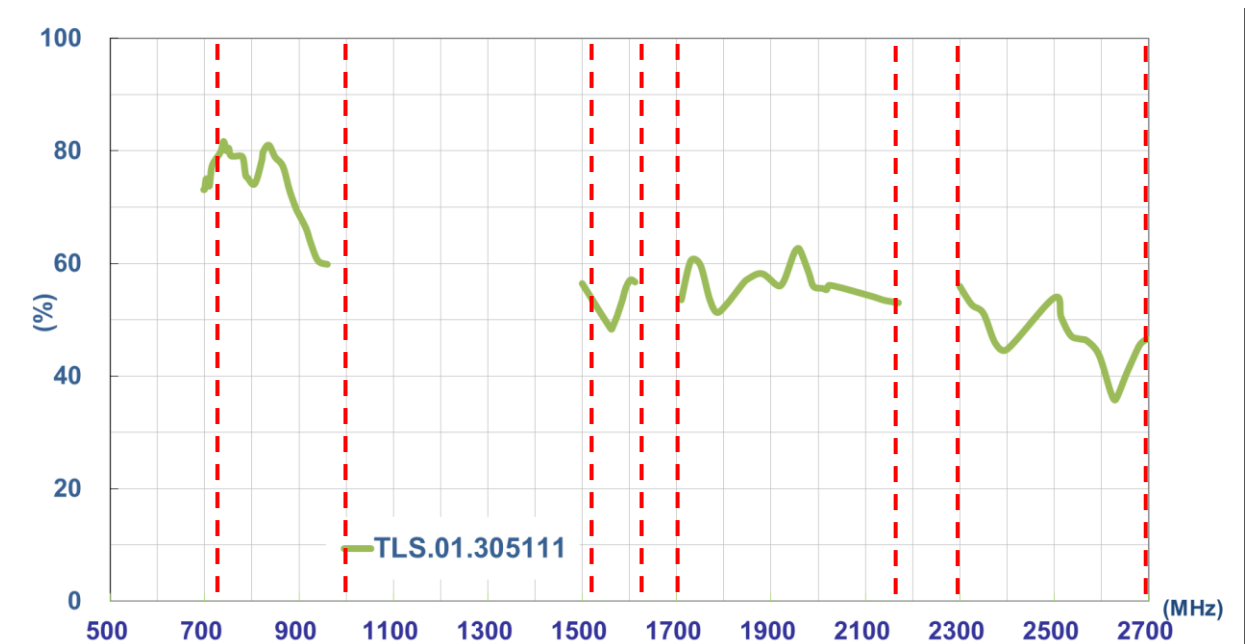

3.3. Average Gain

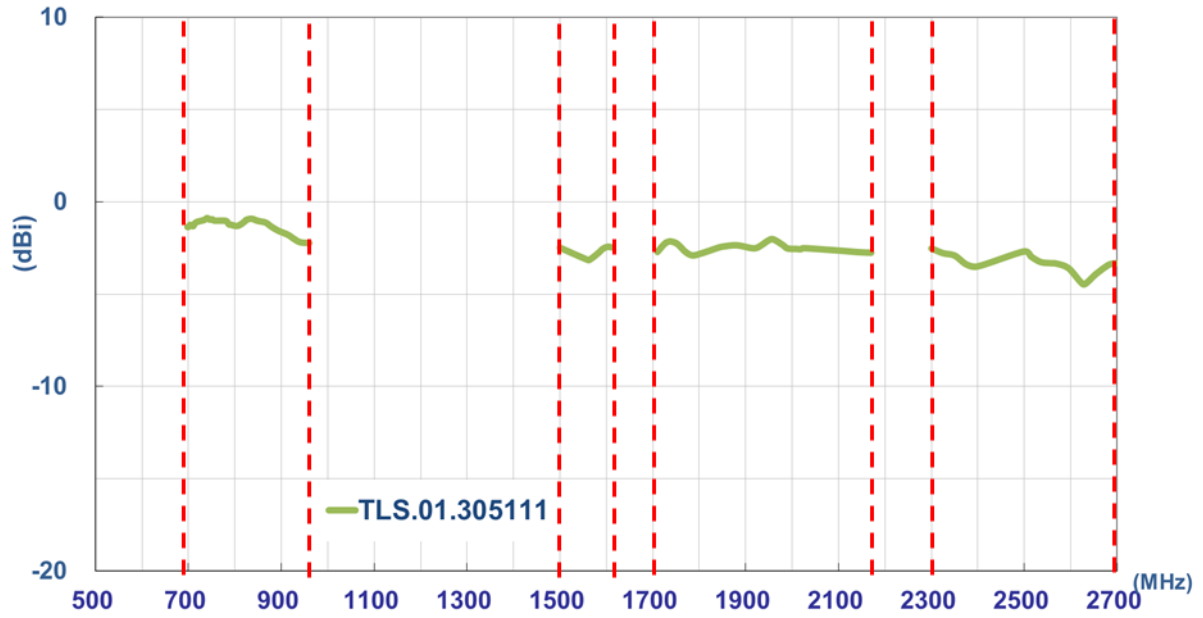

3.4. Peak Gain

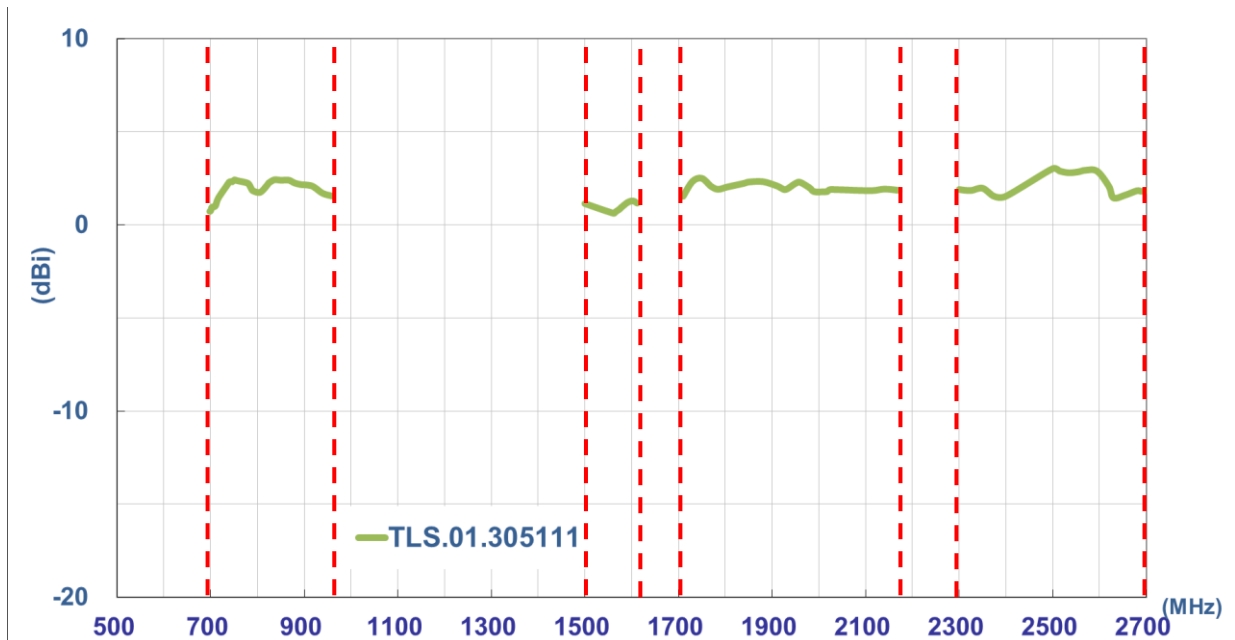

4. Antenna Radiation Pattern

4.1. Measurement Setup

The TLS.01 antenna is tested in a CTIA certified ETS-Lindgren Anechoic Chamber. The test setup is shown below.

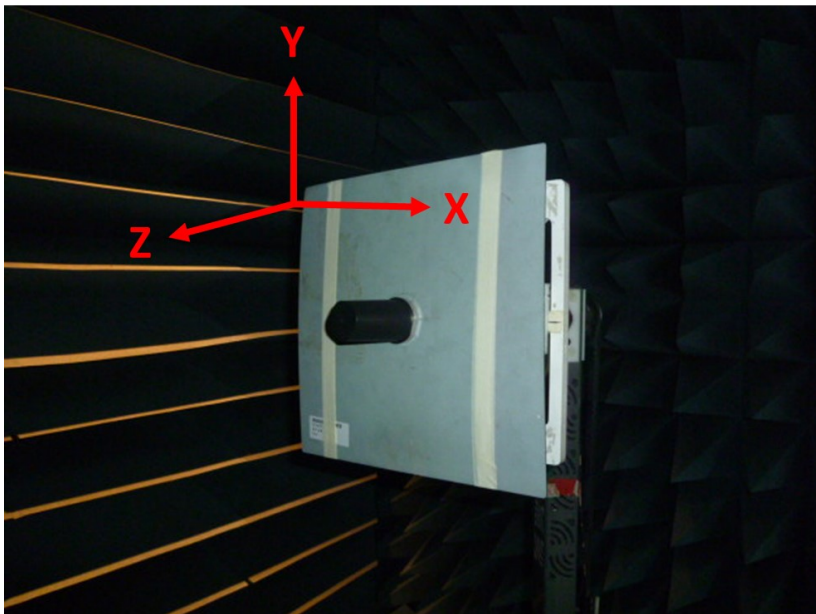

4.2. 2D Radiation Pattern

698-960MHz

XY Plane

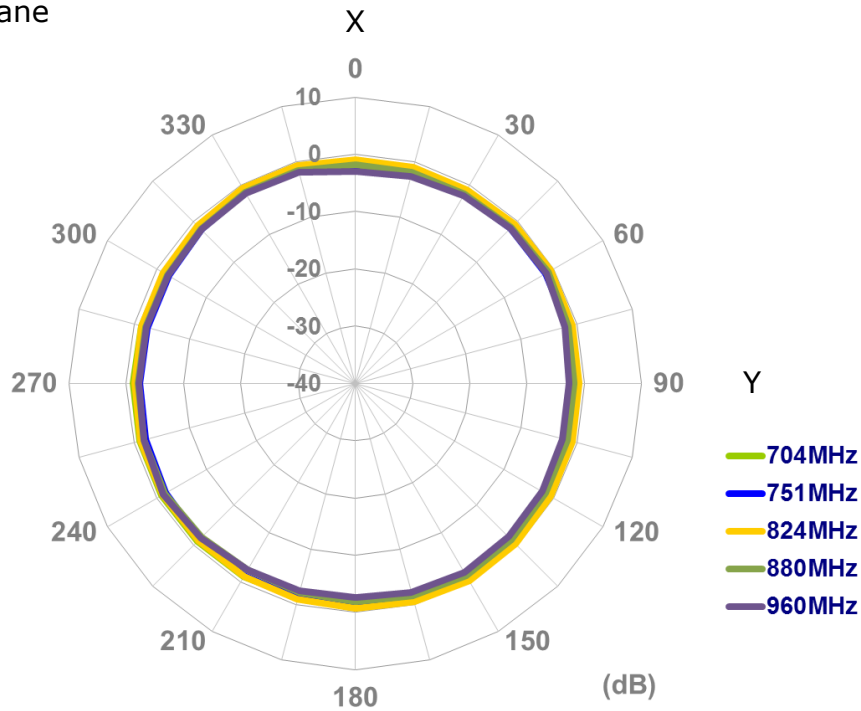

XZ Plane

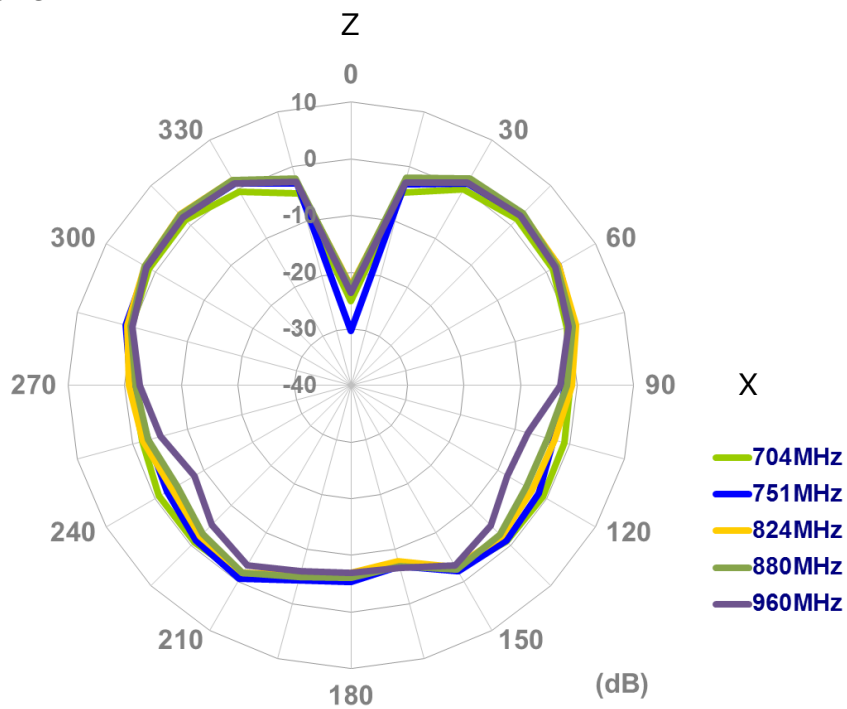

YZ Plane

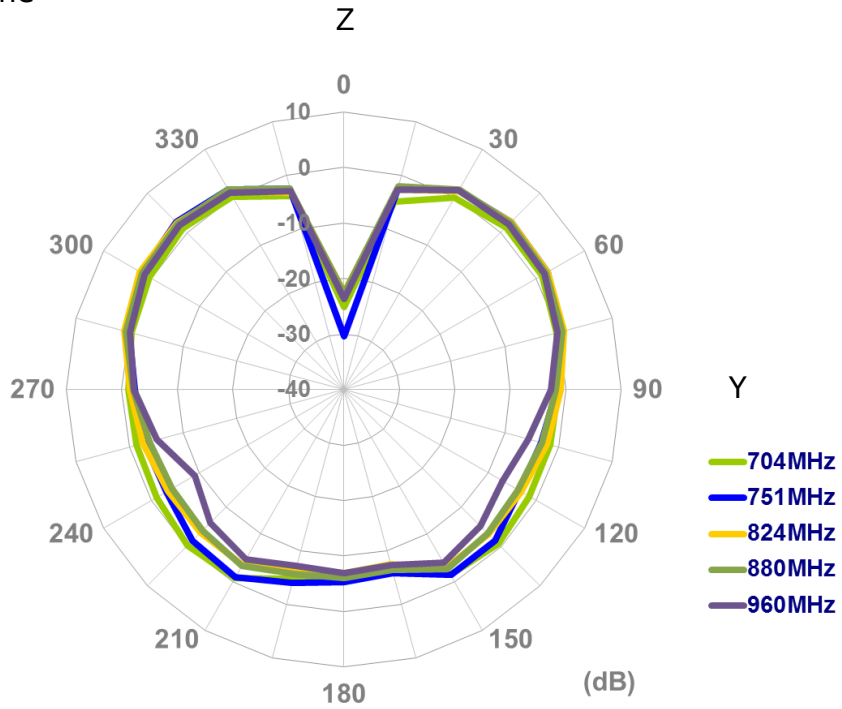

1575.42MHz

XY Plane

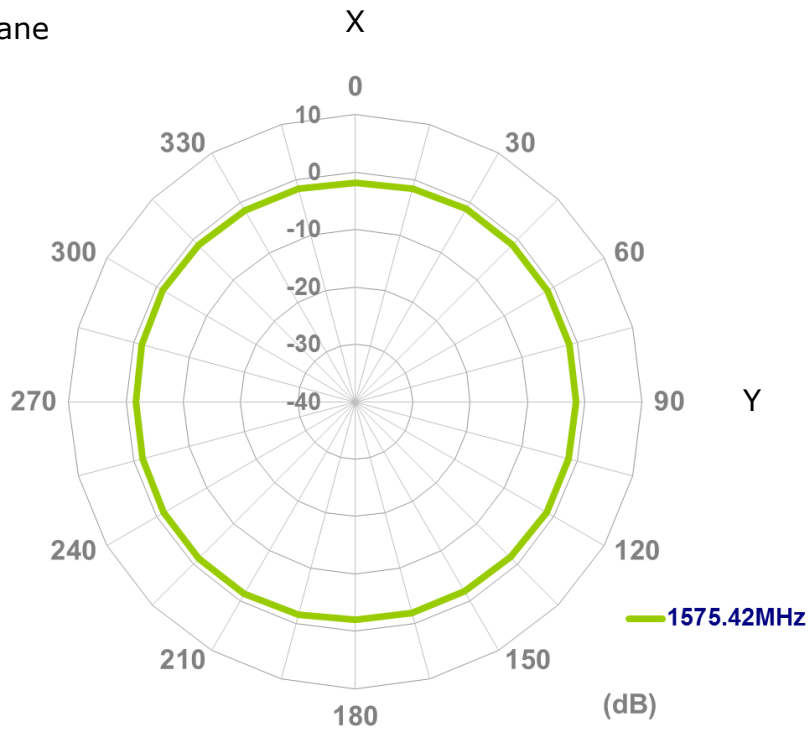

XZ Plane

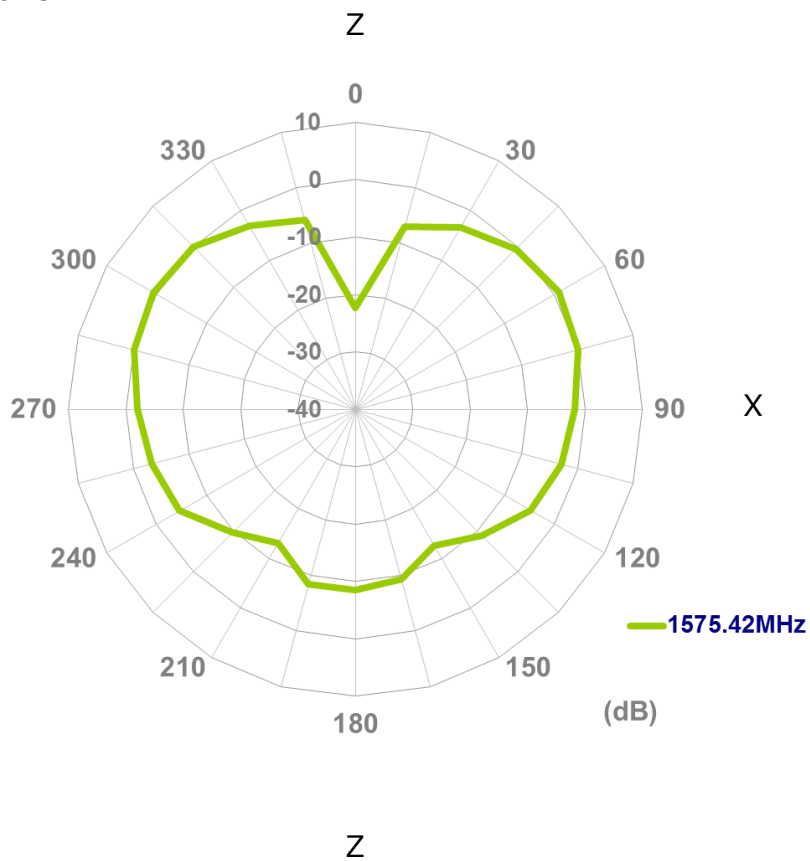



YZ Plane

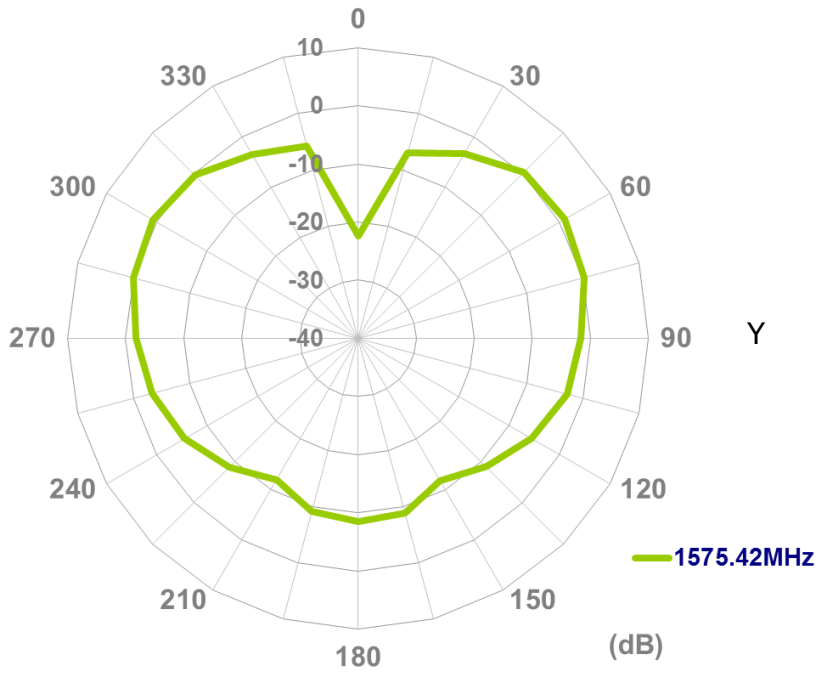

1710-2170MHz

XY Plane

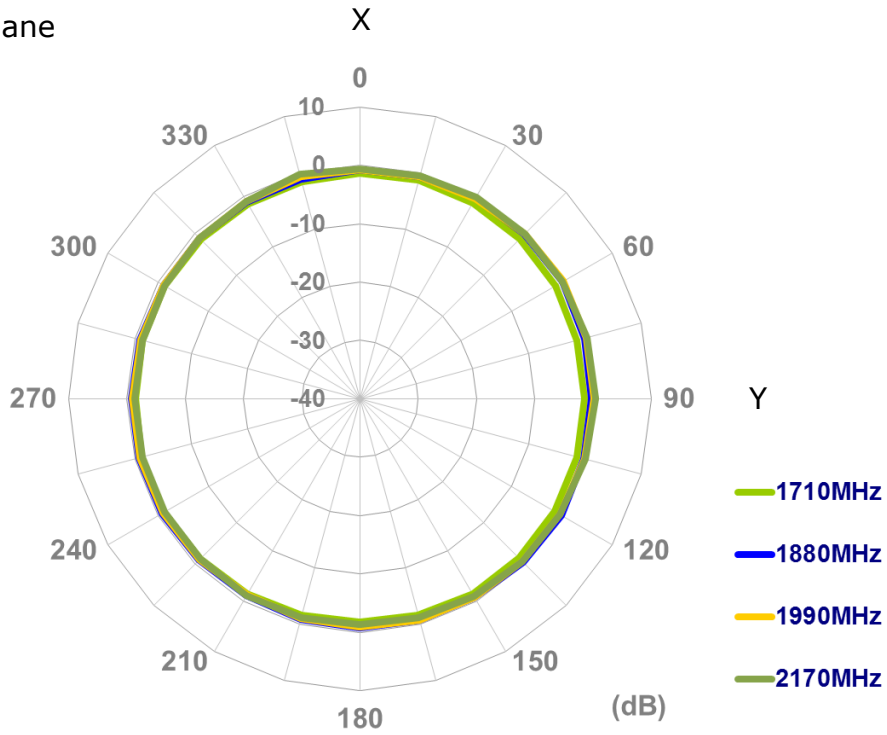

XZ Plane

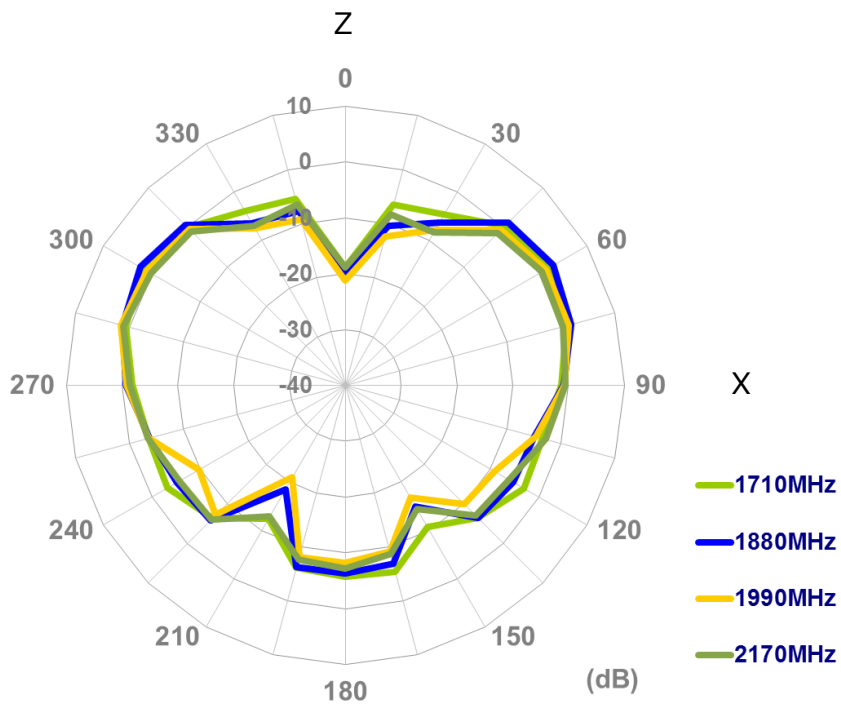



YZ Plane

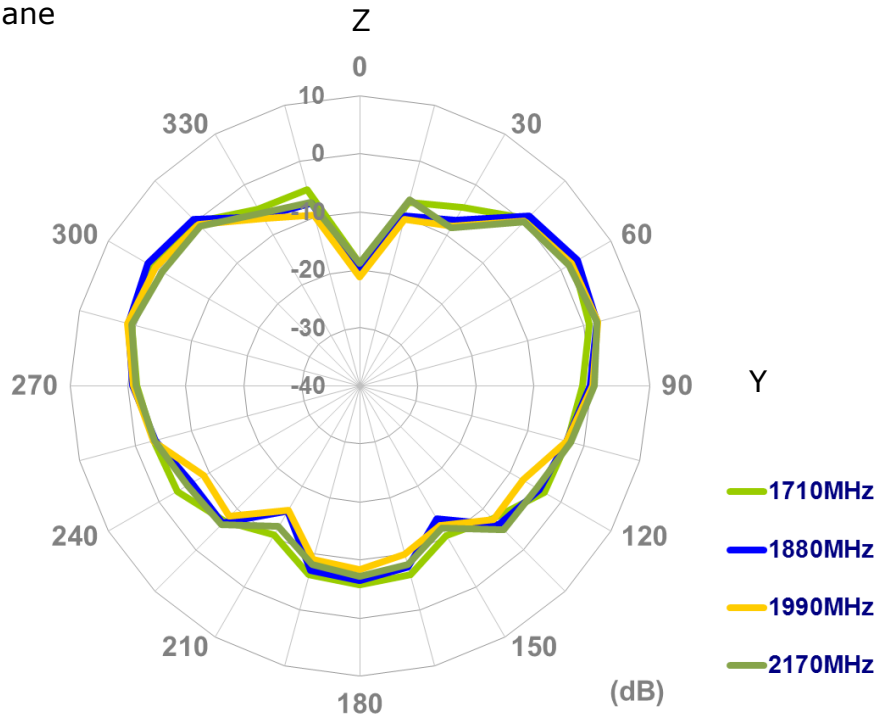

2300-2700MHz

XY Plane

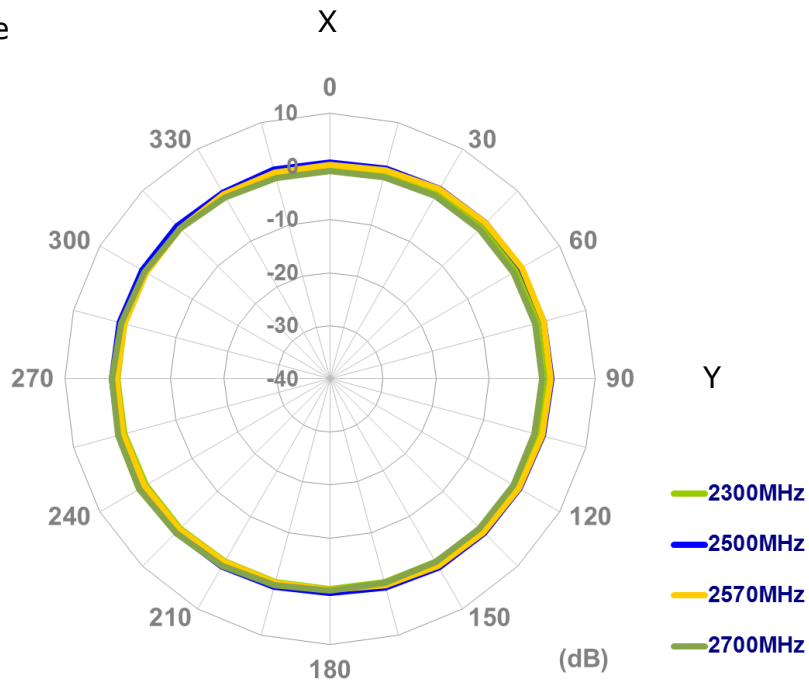

XZ Plane

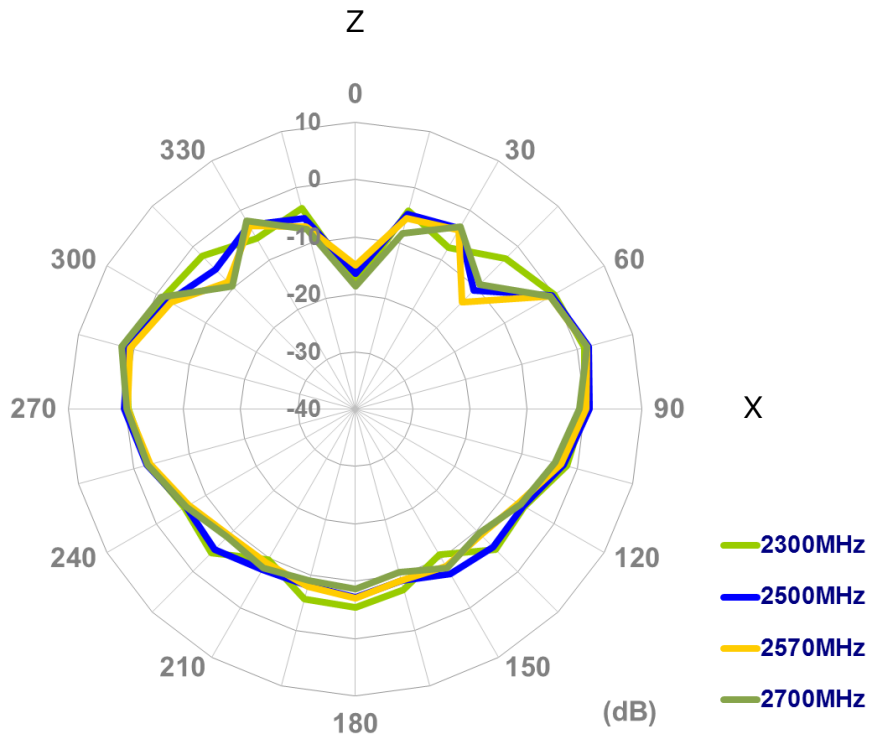



YZ Plane

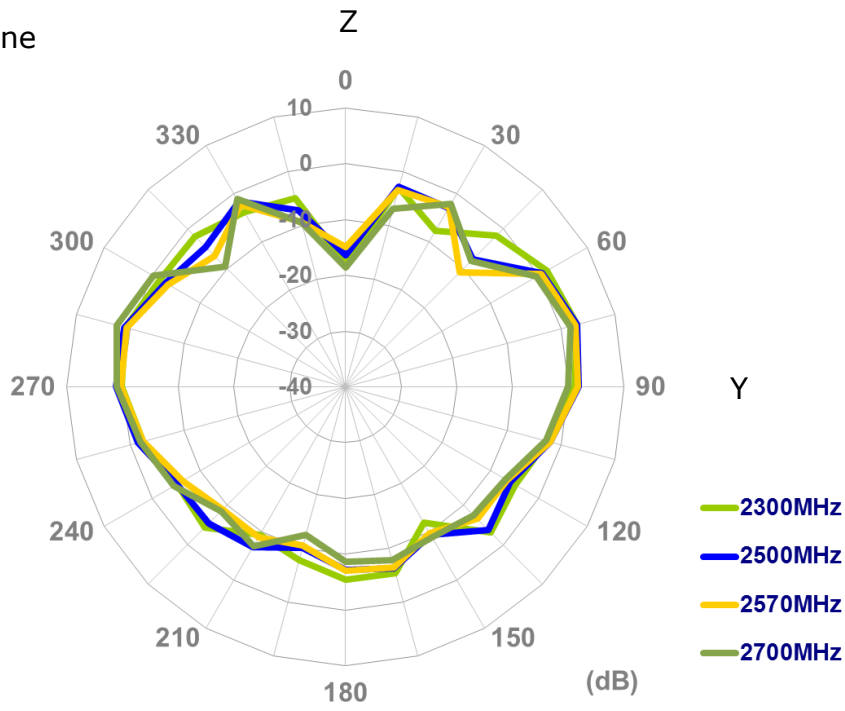

4.3. 3D Radiation Pattern

@751 MHz

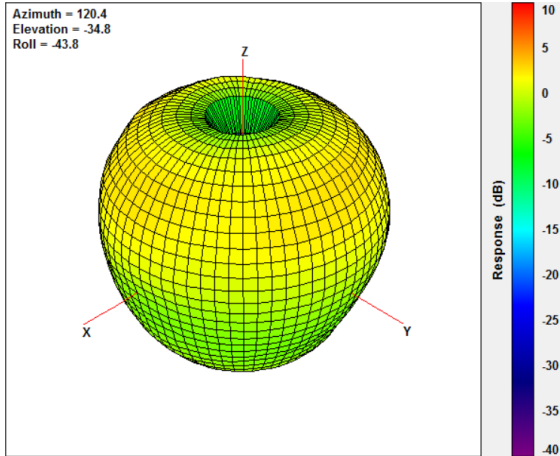

@824 MHz

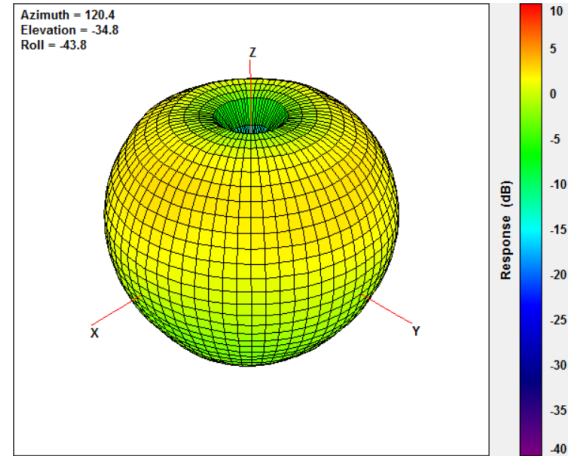

@880 MHz

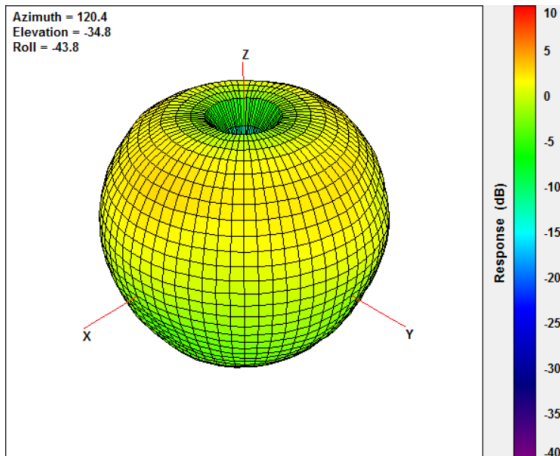

@960 MHz

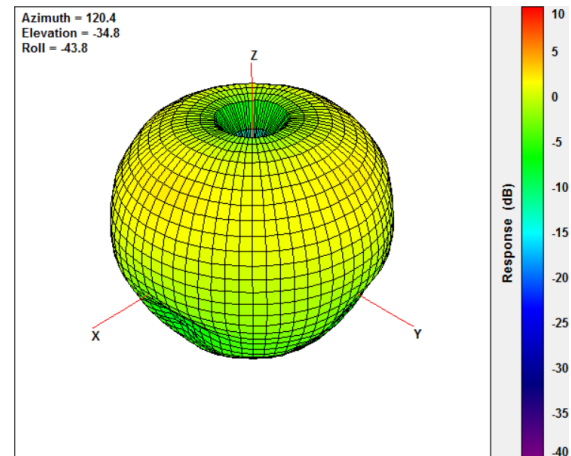

@1575.42 MHz

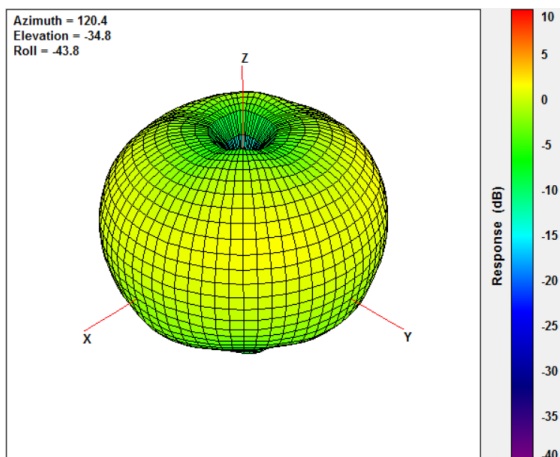

@1710 MHz

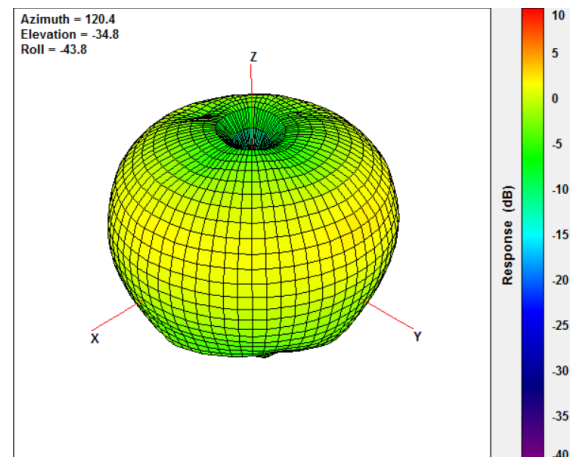

@1880 MHz

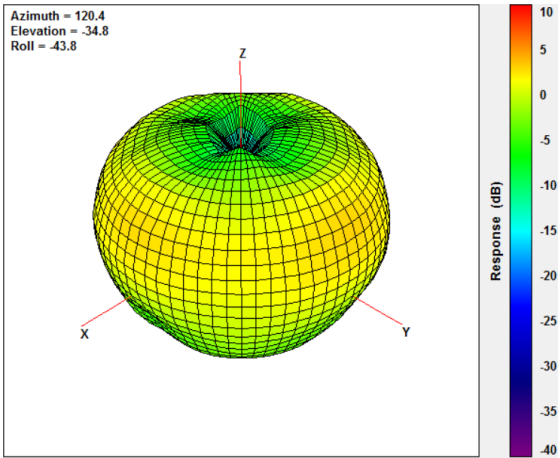

@1990 MHz

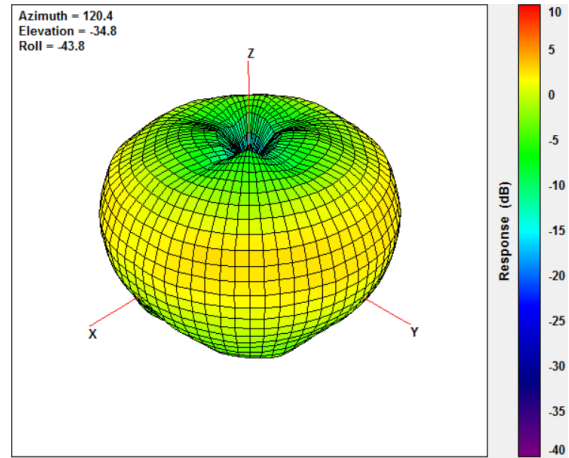

@2170 MHz

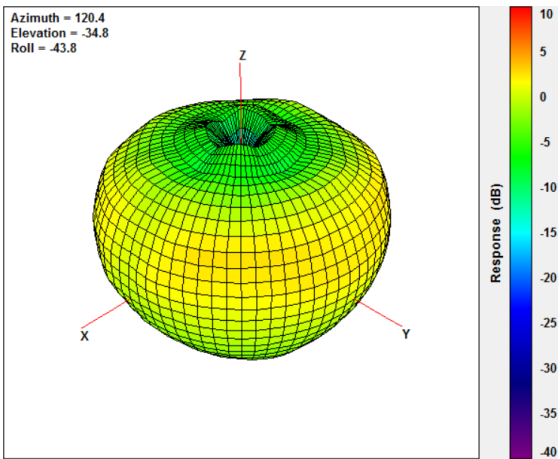

@2300 MHz

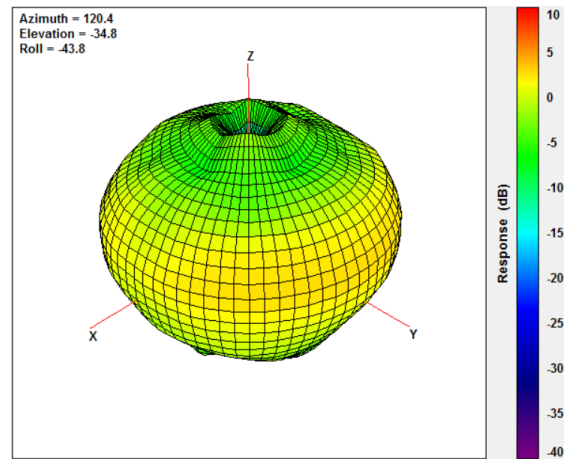

@2690 MHz

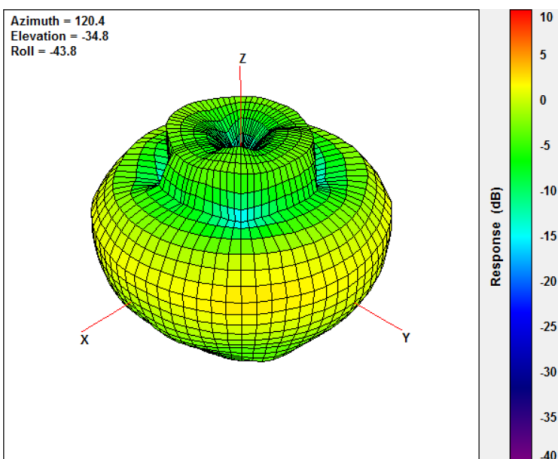

5. Mechanical Drawing

Top View

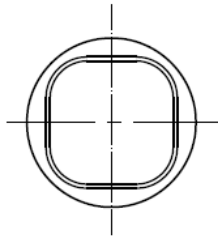

Side View

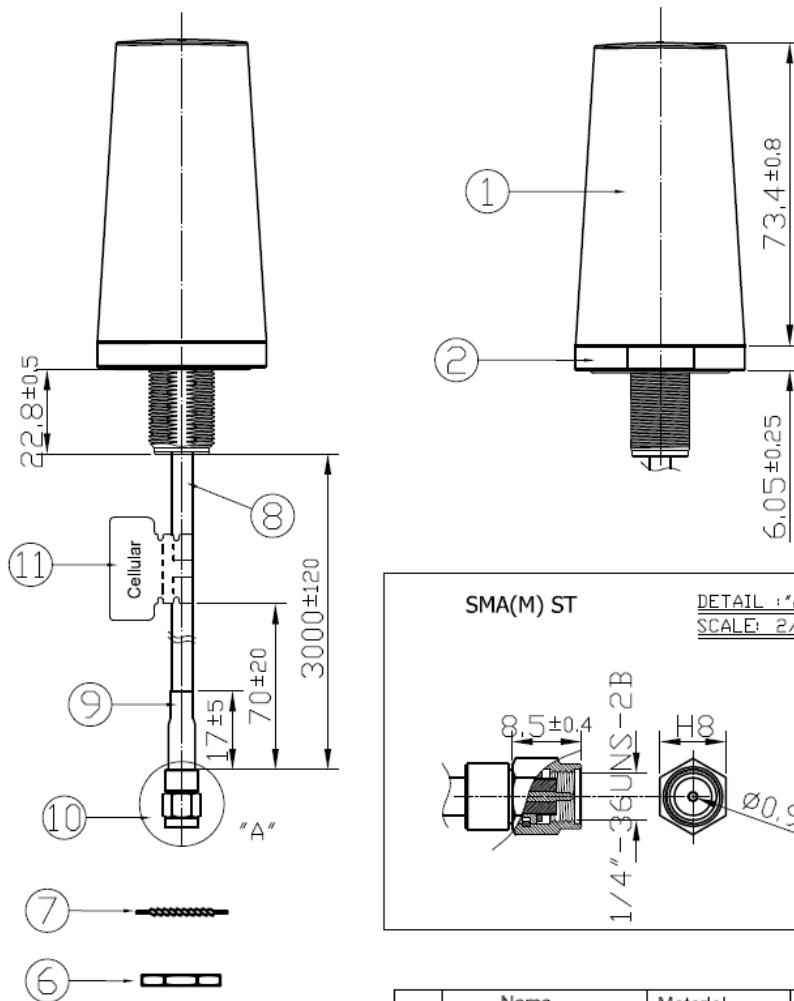

Unit : mm

Bottom View

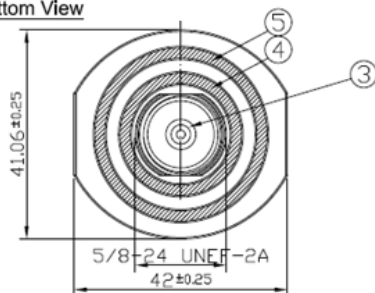

	Name	Material	Finish	QTY
1	Antenna Top	ABS	Black	1
2	Antenna Bottom	Zinc Alloy	Ni Plated	1
3	TLS Thread	Brass	Ni Plated	1
4	O Ring 1	NBR	Black	1
5	O Ring 2	NBR	Black	1
6	Nut	Brass	Ni Plated	1
7	Washer	Brass	Ni Plated	1
8	CFD200 Coaxial Cable	PVC	Black	1
9	Heat Shrink Tube	PE	Black	1
10	SMA(M) ST	Brass	Gold Plated	1
11	Cellular Label	Coated Paper	Blue	1

6. Installation

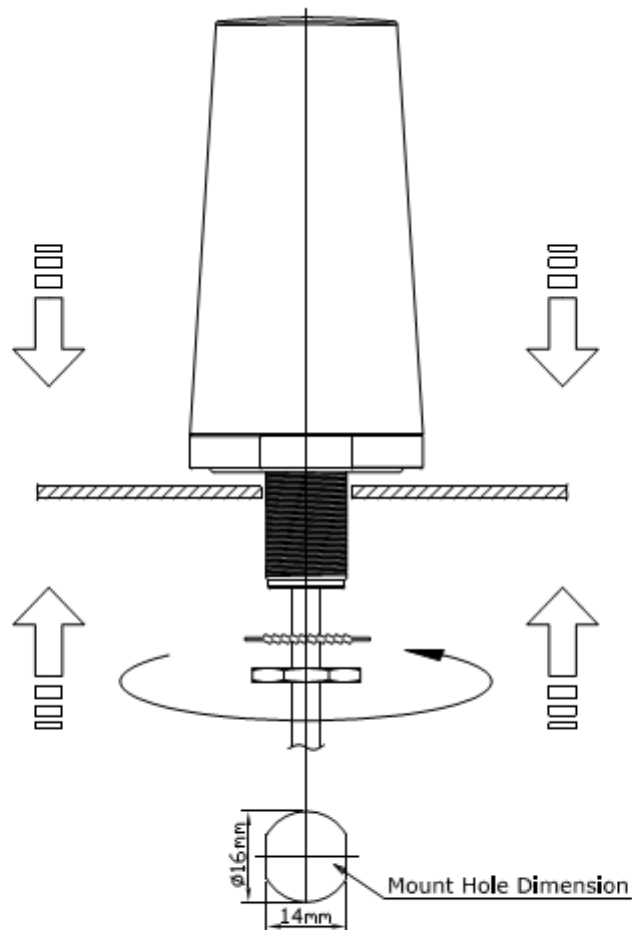

Recommended torque for mounting is 4.018 N.m or 41 kgf.cm

Maximum torque for mounting is 9.8 N.m or 100 kgf.cm

7. Packaging

TLS.01.305111

Packaging Specifications

1 No. TLS.01.305111 per small box
 Box Dimensions - 135 x 135 x 135mm
 Weight - 370g

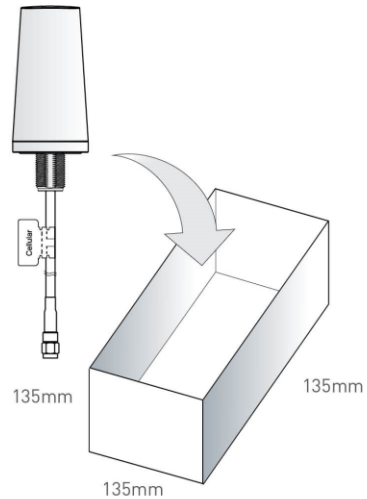

1 Outer Carton
 Carton Dimensions - 430 x 380 x 280mm
 24 pcs TLS.01.305111 per carton
 Weight - 10.2Kg

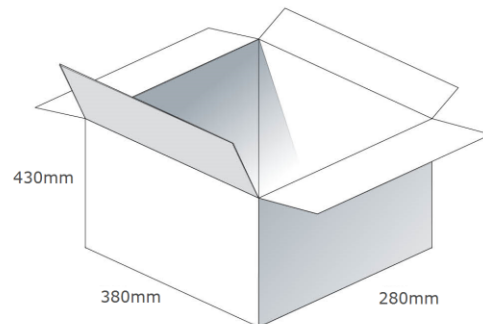

Pallet Dimensions 1100*1100*1510mm
 16 Cartons per Pallet
 4 Cartons per layer
 4 Layers

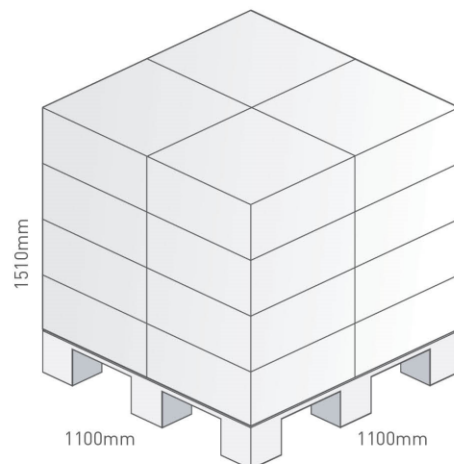

8. Application Note

Antenna performance with different cable lengths is shown below for reference.

- Efficiency

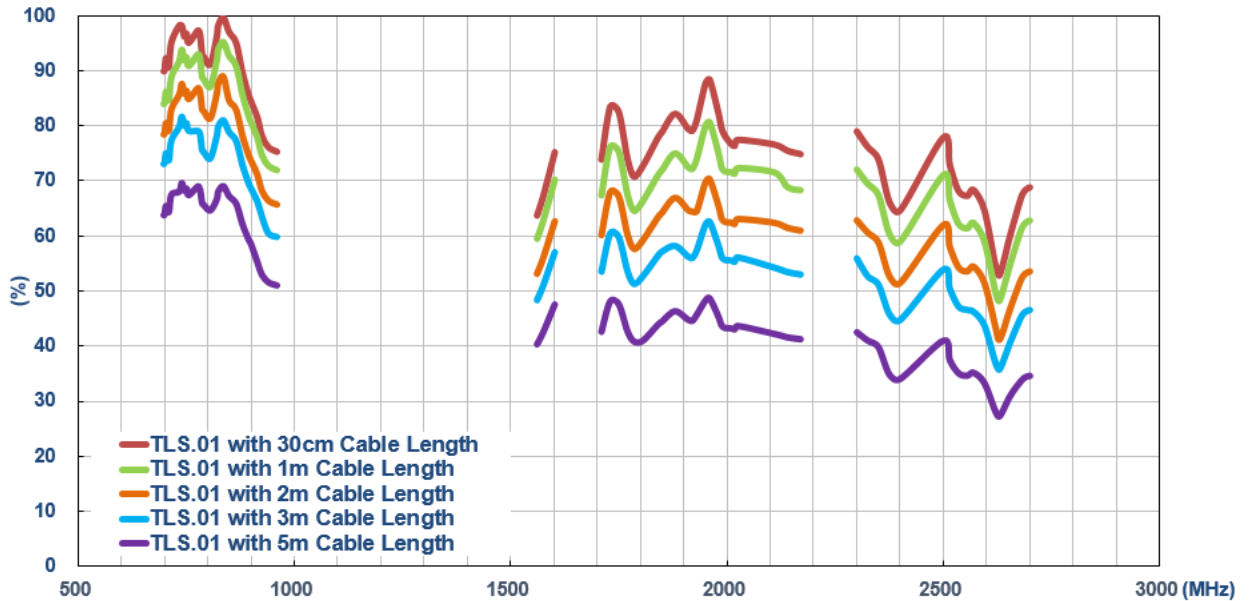

- Peak Gain

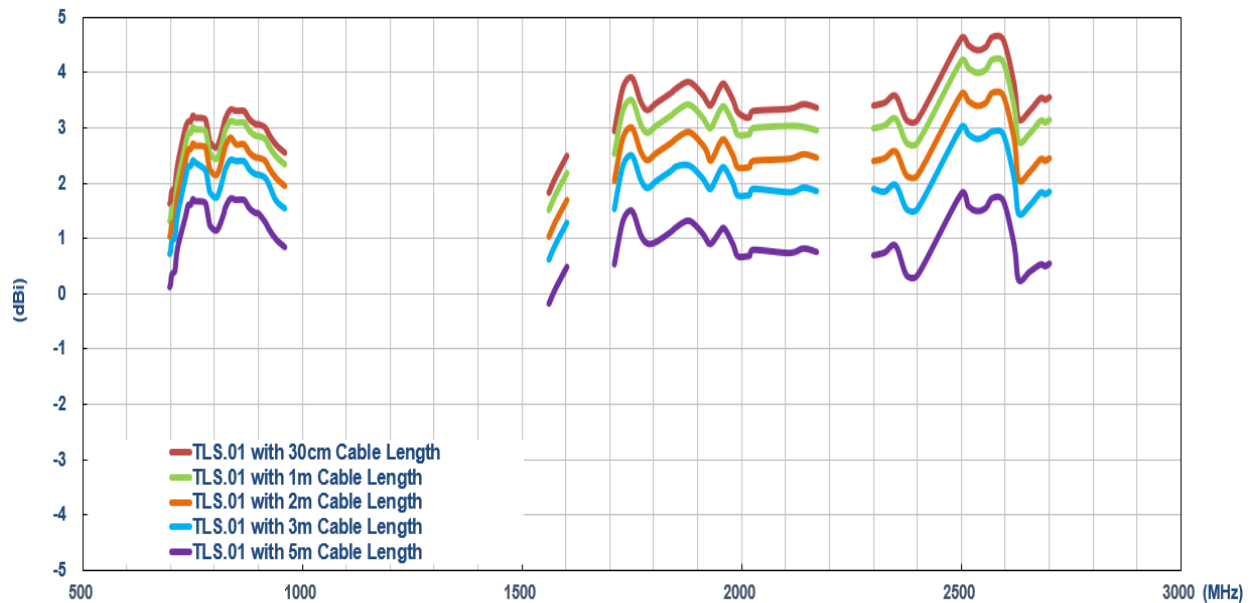

● Average Gain

