

MITSUBISHI IGBT MODULES
CM30MD1-12H
 MEDIUM POWER SWITCHING USE
 FLAT-BASE TYPE, INSULATED TYPE

CM30MD1-12H

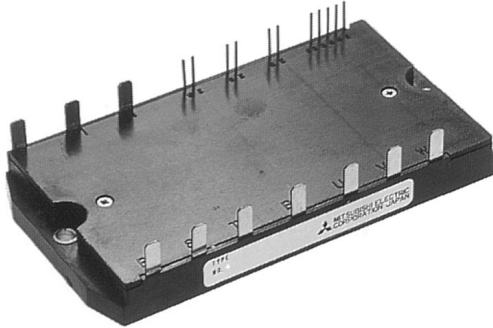

- IC 30A
- VCES 600V
- Insulated Type
- CIB Module
- 3φ Inverter+3φ Converter
- UL Recognized

Yellow Card No. E80276 (N)
 File No. E80271

APPLICATION

AC & DC motor controls, General purpose inverters, Servo controls, NC, Robotics, UPS

OUTLINE DRAWING & CIRCUIT DIAGRAM

Dimensions in mm

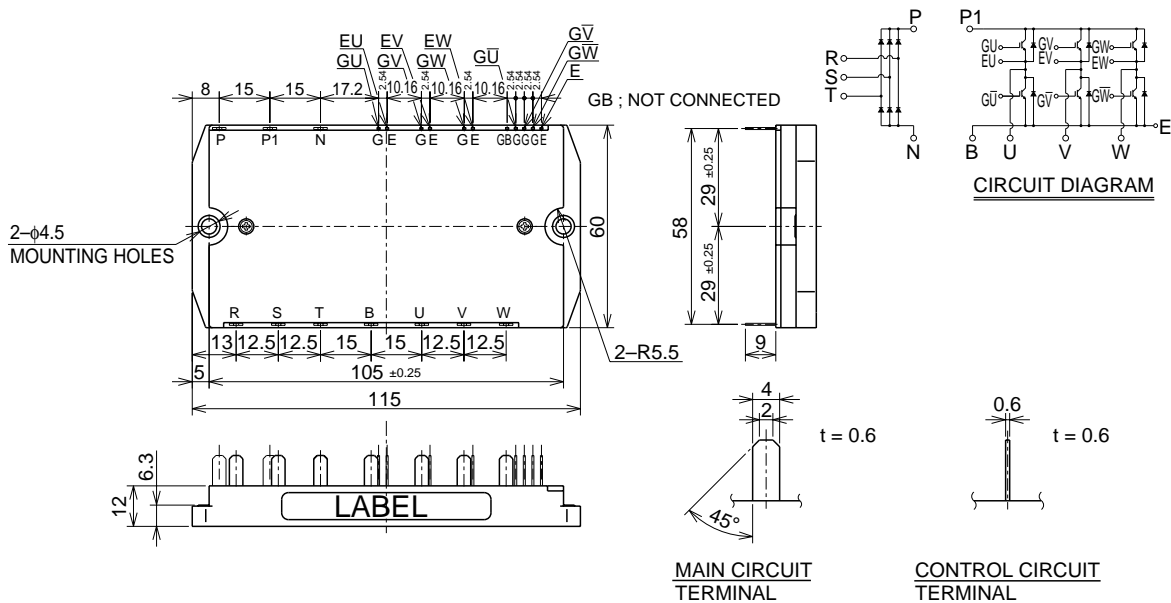

CM30MD1-12H

MEDIUM POWER SWITCHING USE
FLAT-BASE TYPE, INSULATED TYPE**MAXIMUM RATINGS** ($T_j = 25^\circ\text{C}$)
INVERTER PART

Symbol	Parameter	Condition	Rating	Unit
V _{CES}	Collector-emitter voltage	G – E Short	600	V
V _{GES}	Gate-emitter voltage	C – E Short	±20	V
I _C	Collector Current	T _C = 25°C	30	A
I _{CM}		PULSE (Note. 2)	60	A
I _E (Note. 1)	Emitter Current	T _C = 25°C	30	A
I _{EM} (Note. 1)		PULSE (Note. 2)	60	A
P _C (Note. 3)	Maximum collector dissipation	T _f = 25°C	66	W

CONVERTER PART

Symbol	Parameter	Condition	Rating	Unit
V _{RRM}	Repetitive peak reverse voltage		800	V
E _a	Recommended AC input voltage		220	V
I _O	DC output current	3 ϕ rectifying circuit T _f = 123°C	30	A
I _{FSM}	Surge (non-repetitive) forward current	1 cycle at 60Hz, peak value Non-repetitive	550	A
I ² t	I ² t for fusing	Value for one cycle of surge current	1.2X10 ³	A ² s

COMMON RATING

Symbol	Parameter	Condition	Rating	Unit
T _j	Junction temperature		-40 ~ +150	°C
T _{stg}	Storage temperature		-40 ~ +125	°C
V _{iso}	Isolation voltage	AC 1 min.	2500	V
—	Mounting torque	Mounting M4 screw	0.98 ~ 1.47	N · m
—	Weight	Typical value	100	g

CM30MD1-12H

MEDIUM POWER SWITCHING USE
FLAT-BASE TYPE, INSULATED TYPEELECTRICAL CHARACTERISTICS ($T_j = 25^\circ\text{C}$)
INVERTER PART

Symbol	Parameter	Test conditions	Limits			Unit	
			Min.	Typ.	Max.		
ICES	Collector cutoff current	$V_{CE} = V_{CES}, V_{GE} = 0V$	—	—	1	mA	
$V_{GE(th)}$	Gate-emitter threshold voltage	$I_C = 3mA, V_{CE} = 10V$	4.5	6	7.5	V	
IGES	Gate-emitter cutoff current	$V_{GE} = V_{GES}, V_{CE} = 0V$	—	—	0.5	μA	
$V_{CE(sat)}$	Collector-emitter saturation voltage	$I_C = 30A, V_{GE} = 15V$ (Note. 4)	$T_j = 25^\circ\text{C}$	—	2.1	2.8	V
			$T_j = 150^\circ\text{C}$	—	2.15	—	
C_{ies}	Input capacitance	$V_{CE} = 10V$ $V_{GE} = 0V$	—	—	3.0	nF	
C_{oes}	Output capacitance		—	—	2.4	nF	
C_{res}	Reverse transfer capacitance		—	—	0.6	nF	
QG	Total gate charge	$V_{CC} = 300V, I_C = 30A, V_{GE} = 15V$	—	90	—	nC	
$t_d(on)$	Turn-on delay time	$V_{CC} = 300V, I_C = 30A$	—	—	120	ns	
t_r	Turn-on rise time	$V_{GE1} = V_{GE2} = 15V$	—	—	300	ns	
$t_d(off)$	Turn-off delay time	$R_G = 21\Omega$	—	—	200	ns	
t_f	Turn-off fall time	Resistive load	—	—	300	ns	
V_{EC} (Note. 1)	Emitter-collector voltage	$I_E = 30A, V_{GE} = 0V$	—	—	2.8	V	
t_{rr} (Note. 1)	Reverse recovery time	$I_E = 30A, V_{GE} = 0V$	—	—	110	ns	
Q_{rr} (Note. 1)	Reverse recovery charge	$di_e / dt = -60A / \mu s$	—	0.08	—	μC	
$R_{th(j-Q)}$ (Note. 5)	Thermal resistance	IGBT part, Per 1/6 module	—	—	1.9	$^\circ\text{C/W}$	
$R_{th(j-R)}$ (Note. 5)		FWDi part, Per 1/6 module	—	—	2.4	$^\circ\text{C/W}$	

CONVERTER PART

Symbol	Parameter	Condition	Limits			Unit
			Min.	Typ.	Max.	
IRRM	Repetitive reverse current	$V_R = V_{RRM}, T_j = 150^\circ\text{C}$	—	—	8	mA
VFM	Forward voltage drop	$I_F = 30A$	—	—	1.5	V
$R_{th(j-I)}$ (Note. 5)	Thermal resistance	Per 1/6 module	—	—	1.7	$^\circ\text{C/W}$

- Note 1. I_E , V_{EC} , t_{rr} , Q_{rr} & di_e/dt represent characteristics of the anti-parallel, emitter to collector free-wheel diode.
 2. Pulse width and repetition rate should be such that the device junction temp. (T_j) does not exceed T_{jmax} rating.
 3. Junction temperature (T_j) should not increase beyond 150°C .
 4. Pulse width and repetition rate should be such as to cause negligible temperature rise.
 5. Thermal resistance is specified under following conditions.
 • The conductive grease applied, between module and fin.
 • Al plate is used as fin.

CM30MD1-12H

MEDIUM POWER SWITCHING USE
FLAT-BASE TYPE, INSULATED TYPE

PERFORMANCE CURVES

OUTPUT CHARACTERISTICS (TYPICAL)

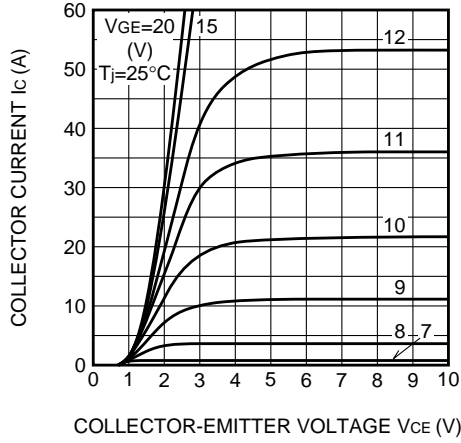

TRANSFER CHARACTERISTICS (TYPICAL)

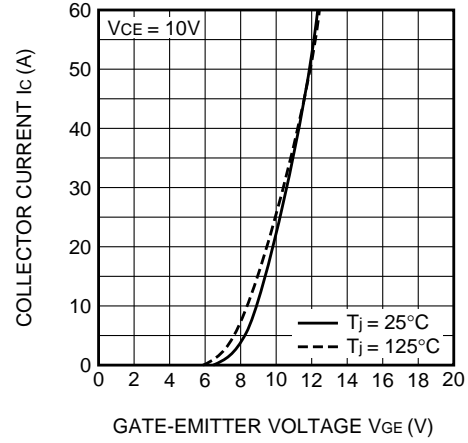

COLLECTOR-EMITTER SATURATION VOLTAGE CHARACTERISTICS (TYPICAL)

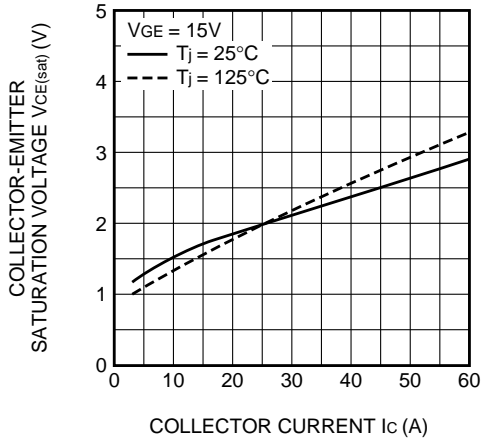

COLLECTOR-EMITTER SATURATION VOLTAGE CHARACTERISTICS (TYPICAL)

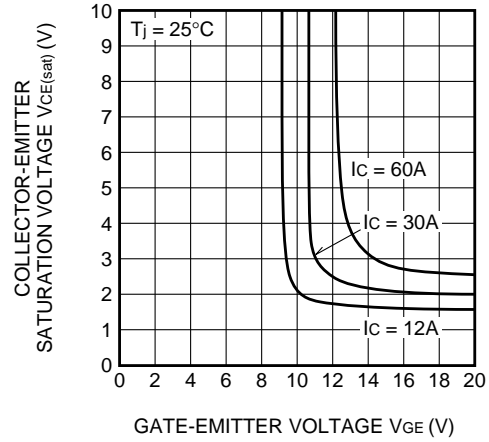

FREE-WHEEL DIODE FORWARD CHARACTERISTICS (TYPICAL)

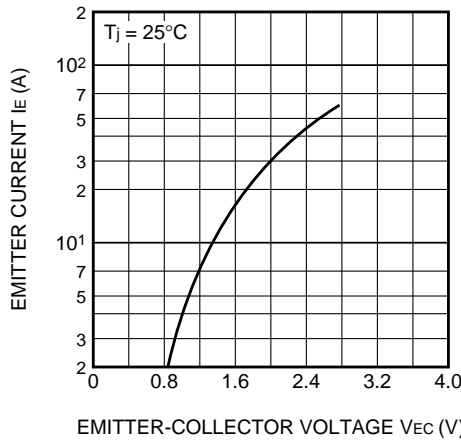

CAPACITANCE VS. Vce (TYPICAL)

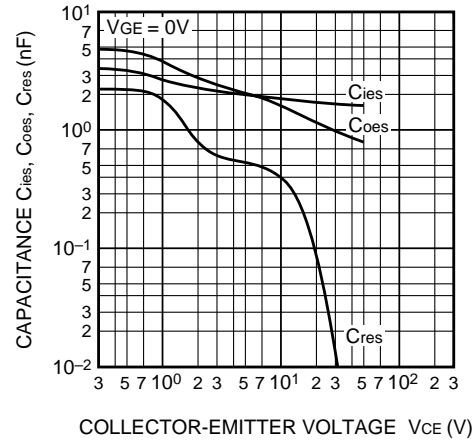

CM30MD1-12H

MEDIUM POWER SWITCHING USE
FLAT-BASE TYPE, INSULATED TYPE

HALF-BRIDGE SWITCHING CHARACTERISTICS (TYPICAL)

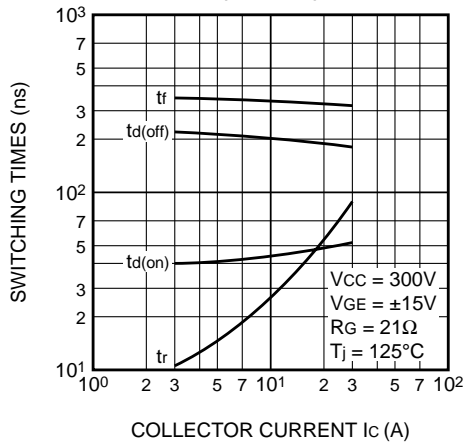

REVERSE RECOVERY CHARACTERISTICS OF FREE-WHEEL DIODE (TYPICAL)

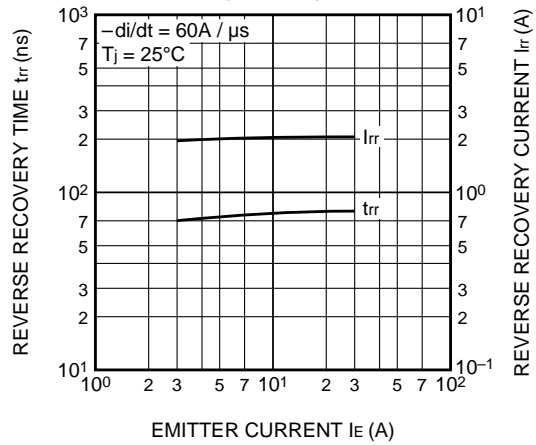

TRANSIENT THERMAL IMPEDANCE CHARACTERISTICS (IGBT part)

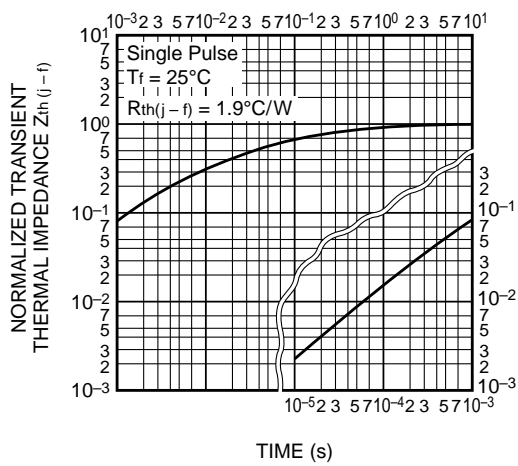

TRANSIENT THERMAL IMPEDANCE CHARACTERISTICS (FWDi part)

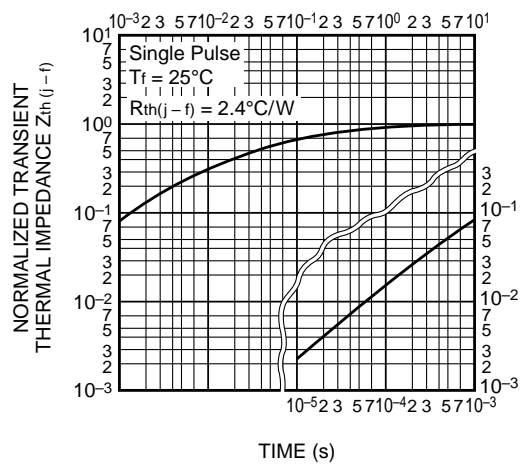

VGE - GATE CHARGE (TYPICAL)

