

03

031798-2

Circular connectors with threaded joint M16 acc. to IEC 61076-2-106, IP40/IP67/IP68



SWUM™ chassis plug acc. to IEC 61076-2-106 and AISG specification, IP 68/67, with threaded joint and ground contact, for printed circuit boards, manual soldering, for back side mounting

03 031798-2

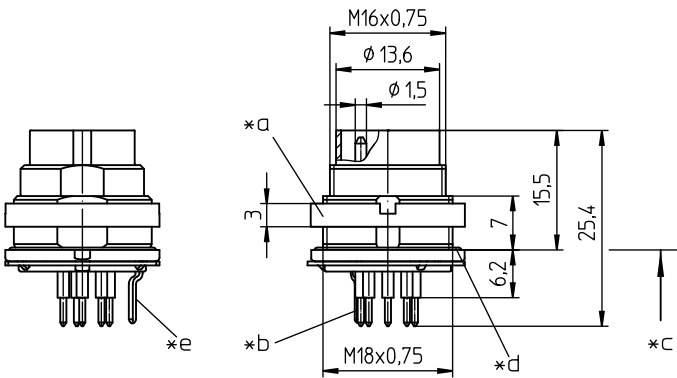
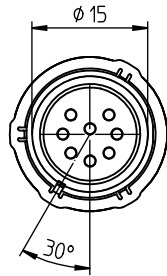
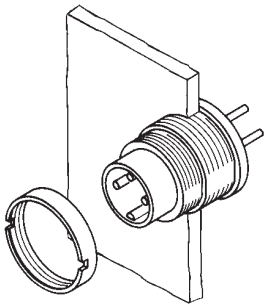

Environmental conditions

Temperature range -40 °C/+85 °C

Materials

Insulating body	PA, V-2 according to UL94
Contact pin	CuZn, silver-plated and flash gold-plated, tin-plated in solder area
Ground contact	CuZn, pre-nickel and tin-plated
Housing	Zn diecast, pre-copper and nickel-plated
Ring screw	CuZn, nickel-plated
Seal	NBR

Mechanical data

Protection class IP68/67¹

¹ according to IEC 60529/DIN EN 60529

IP68: sealed in locked position; pair of appropriate connectors in locked position is sealed against ingress of dust and moisture.







IP67: sealed when unmated (SWUM™); no dust or moisture can ingress into the inside of the device through an unmated connector accidentally left unprotected.
IPX8 requirements under agreement between user and manufacturer

Electrical data (at T_{amb} 20 °C)





Rated current	5 A (T _{amb} 40 °C)
Rated voltage	60 V
Rated impulse voltage	1 kV/60 s
Material group	II (IEC)/1 (UL) (CTI ≥ 450)
Overvoltage category	I
Insulation resistance	> 100 MΩ

Associated products

Counterparts

 0321	 0322	 0322-1
 032200	 0360	 036000

Accessories

 0383	 038399	 0384
 0385	 038899	

03

031798-2

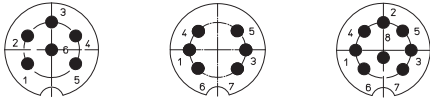
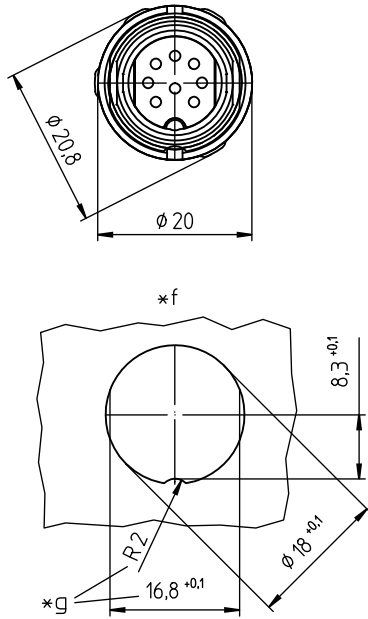

08-a

- 031798-2 06-1 031798-2 08-1

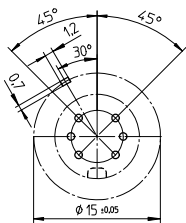

031798-2 06-1

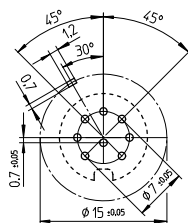

08-a

031798-2 08-1

- *a nut enclosed separately
- *b for bore hole in printed circuit board $\varnothing 1$ mm
- *c mounting direction
- *d O-ring gasket
- *e ground contact
- *f port in mounting plate
- *g anti-rotation, alternative execution

03

031798-2

Designation	Pole Number	PU (Pieces)	MDQ (Pieces)
031798-2 06-1	6	50	100
031798-2 08-1	8	50	100

Packaging:

in a cardboard box