



LIGITEK

LIGITEK ELECTRONICS CO.,LTD.  
Property of Ligitek Only

---

DUAL DIGIT LED DISPLAY (0.25Inch)



Lead-Free Parts

## LDD215/62-XX/S2-PF

# DATA SHEET

DOC. NO : QW0905-LDD215/62-XX/S2-PF

REV. : A

DATE : 12 - Sep. - 2006



### Package Dimensions

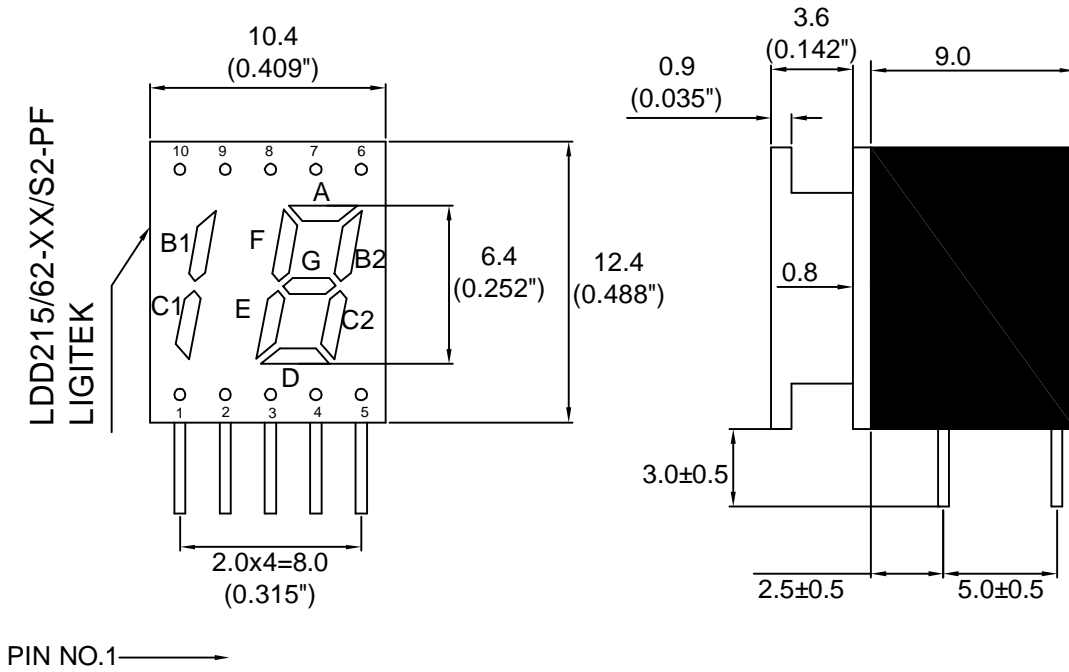

Note : 1.All dimension are in millimeters and (Inch) tolerance is  $\pm 0.25\text{mm}$  unless otherwise noted.  
2.Specifications are subject to change without notice.



Internal Circuit Diagram

LDD2152-XX/S2-PF

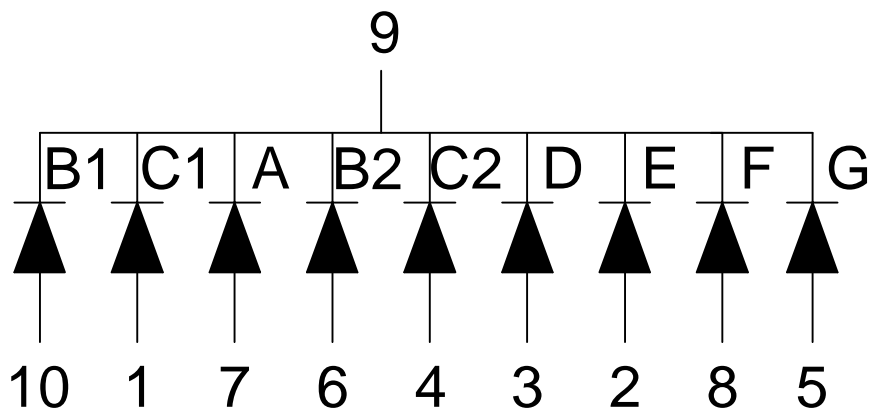

LDD2162-XX/S2-PF

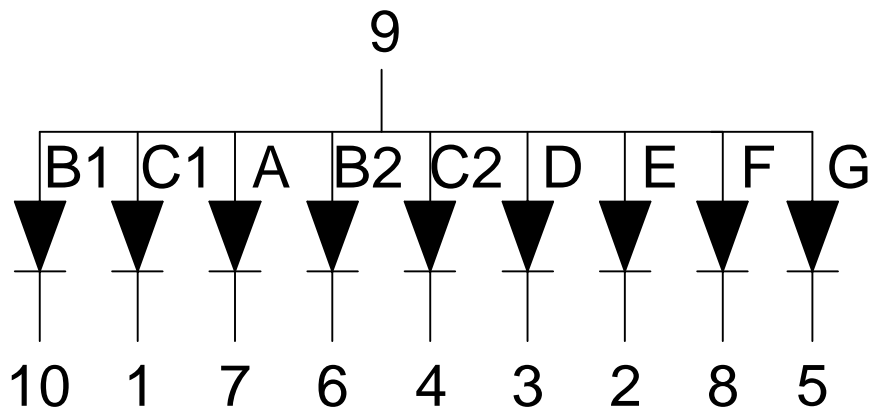



### Electrical Connection

PIN NO.1	LDD2152-XX/S2-PF	PIN NO.1	LDD2162-XX/S2-PF
1	Anode C1	1	Cathode C1
2	Anode E	2	Cathode E
3	Anode D	3	Cathode D
4	Anode C2	4	Cathode C2
5	Anode G	5	Cathode G
6	Anode B2	6	Cathode B2
7	Anode A	7	Cathode A
8	Anode F	8	Cathode F
9	Common Cathode	9	Common Anode
10	Anode B1	10	Cathode B1



Absolute Maximum Ratings at Ta=25 °C

Parameter	Symbol	Ratings	UNIT
		G	
Forward Current Per Chip	IF	30	mA
Peak Forward Current Per Chip (Duty 1/10,0.1ms Pulse Width)	IFP	120	mA
Power Dissipation Per Chip	PD	100	mW
Reverse Current Per Any Chip	Ir	10	μA
Operating Temperature	Topr	-25 ~ +85	°C
Storage Temperature	Tstg	-25 ~ +85	°C
Solder Temperature 1/16 Inch Below Seating Plane For 3 Seconds At 260 °C			

Part Selection And Application Information(Ratings at 25°C)

PART NO	CHIP		common cathode or anode	λ P (nm)	Δ λ (nm)	Electrical					IV-M
	Material	Emitted				Vf(v)			Iv(mcd)		
						Min.	Typ.	Max.	Min.	Typ.	
LDD2152-XX/S2-PF	GaP	Green	Common Cathode	565	30	1.7	2.1	2.6	0.05	0.08	2:1
LDD2162-XX/S2-PF			Common Anode								

Note : 1.The forward voltage data did not including ±0.1V testing tolerance.  
2. The luminous intensity data did not including ±15% testing tolerance.

**Test Condition For Each Parameter**

Parameter	Symbol	Unit	Test Condition
Forward Voltage Per Chip	V <sub>f</sub>	volt	I <sub>f</sub> =20mA
Luminous Intensity Per Chip	I <sub>v</sub>	mcd	I <sub>f</sub> =10mA
Peak Wavelength	$\lambda P$	nm	I <sub>f</sub> =20mA
Spectral Line Half-Width	$\Delta \lambda$	nm	I <sub>f</sub> =20mA
Reverse Current Any Chip	I <sub>r</sub>	$\mu A$	V <sub>r</sub> =5V
Luminous Intensity Matching Ratio	IV-M		



### Typical Electro-Optical Characteristics Curve

G CHIP

Fig.1 Forward current vs. Forward Voltage

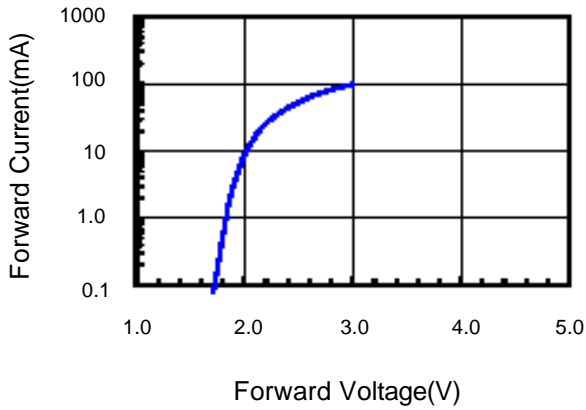

Fig.2 Relative Intensity vs. Forward Current

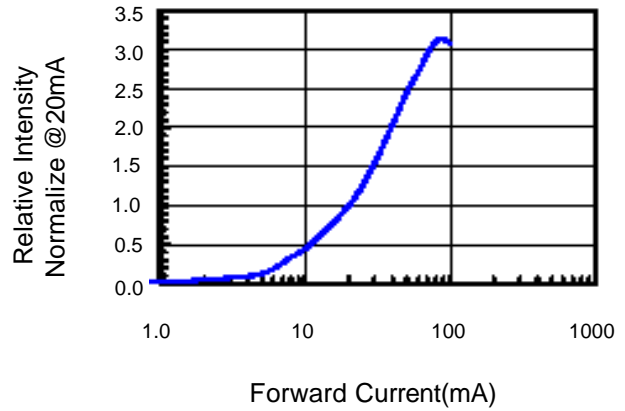

Fig.3 Forward Voltage vs. Temperature

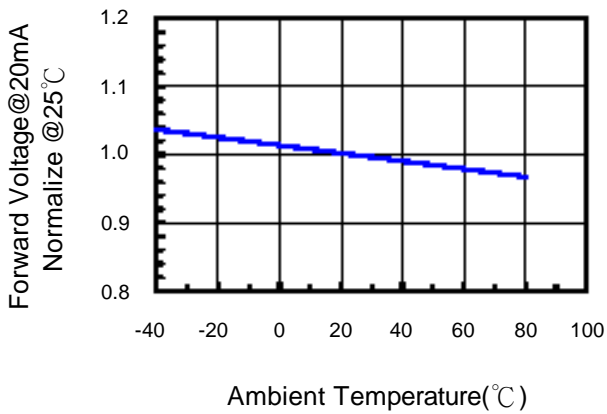

Fig.4 Relative Intensity vs. Temperature

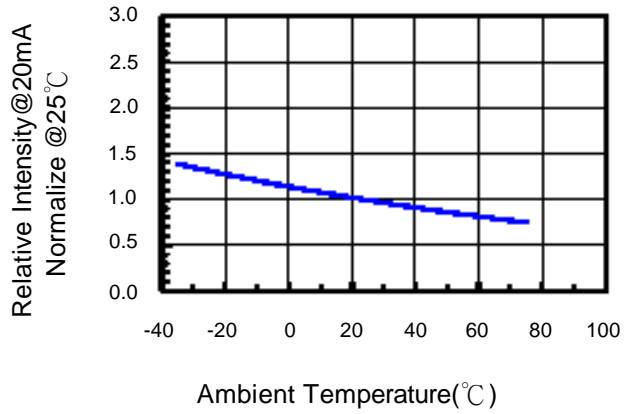
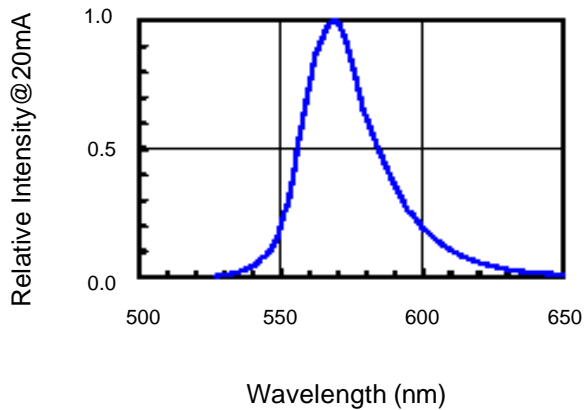

Fig.5 Relative Intensity vs. Wavelength





### Soldering Condition(Pb-Free)

#### 1.Iron:

Soldering Iron:30W Max

Temperature 350° C Max

Soldering Time:3 Seconds Max(One time only)

Distance:Solder Temperature 1/16 Inch Below Seating  
Plane For 3 Seconds At 260° C

#### 2.Wave Soldering Profile

Dip Soldering

Preheat: 120° C Max

Preheat time: 60seconds Max

Ramp-up

2° C/sec(max)

Ramp-Down:-5° C/sec(max)

Solder Bath:260° C Max

Dipping Time:3 seconds Max

Distance:Solder Temperature 1/16 Inch Below Seating  
Plane For 3 Seconds At 260° C

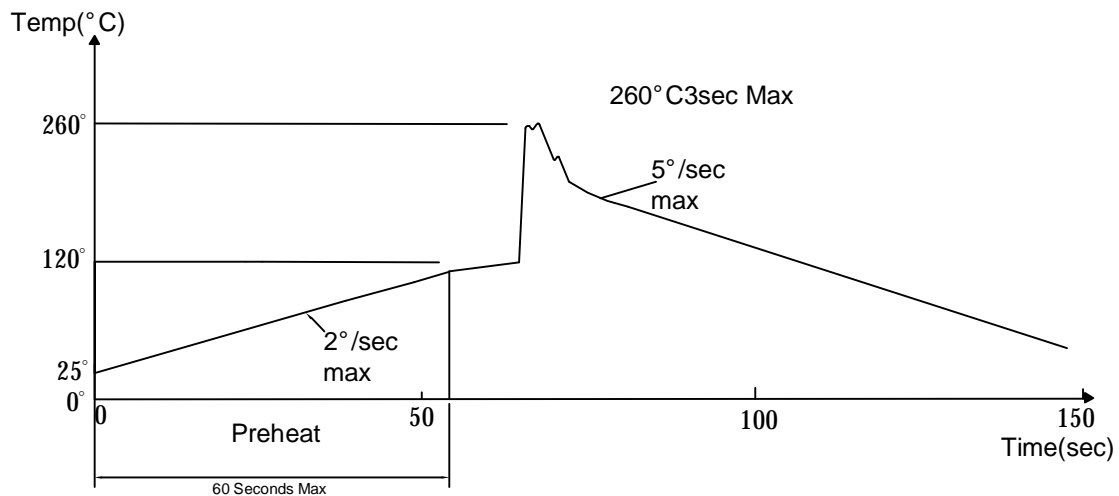

Note: 1.Wave solder should not be made more than one time.  
2.You can just only select one of the soldering conditions as above.





Reliability Test:

Test Item	Test Condition	Description	Reference Standard
Operating Life Test	1.Under Room Temperature 2.If=10mA 3.t=1000 hrs (-24hrs, +72hrs)	This test is conducted for the purpose of determining the resistance of a part in electrical and thermal stressed.	MIL-STD-750: 1026 MIL-STD-883: 1005 JIS C 7021: B-1
High Temperature Storage Test	1.Ta=105 °C±5°C 2.t=1000 hrs (-24hrs, +72hrs)	The purpose of this is the resistance of the device which is laid under condition of high temperature for hours.	MIL-STD-883:1008 JIS C 7021: B-10
Low Temperature Storage Test	1.Ta=-40 °C±5°C 2.t=1000 hrs (-24hrs, +72hrs)	The purpose of this is the resistance of the device which is laid under condition of low temperature for hours.	JIS C 7021: B-12
High Temperature High Humidity Test	1.Ta=65 °C±5°C 2.RH=90%-95% 3.t=240hrs ±2hrs	The purpose of this test is the resistance of the device under tropical for hours.	MIL-STD-202:103B JIS C 7021: B-11
Thermal Shock Test	1.Ta=105 °C±5°C & -40 °C±5°C (10min) (10min) 2.total 10 cycles	The purpose of this is the resistance of the device to sudden extreme changes in high and low temperature.	MIL-STD-202: 107D MIL-STD-750: 1051 MIL-STD-883: 1011
Solder Resistance Test	1.T.Sol=260 °C±5°C 2.Dwell time= 10 ±1sec.	This test intended to determine the thermal characteristic resistance of the device to sudden exposures at extreme changes in temperature when soldering the lead wire.	MIL-STD-202: 210A MIL-STD-750: 2031 JIS C 7021: A-1
Solderability Test	1.T.Sol=230 °C±5°C 2.Dwell time=5 ±1sec	This test intended to see soldering well performed or not.	MIL-STD-202: 208D MIL-STD-750: 2026 MIL-STD-883: 2003 JIS C 7021: A-2