

# MOS FET Relays G3VM-61A1/D1

**Compact, General-purpose, Analog-switching MOS FET Relay, with Dielectric Strength of 2.5 kVAC between I/O Using Optical Isolation**

- Upgraded G3VM-61 A/D Series.
- Switches minute analog signals.
- RoHS Compliant.

■ **Application Examples**

- Measurement devices
- Security systems
- Amusement machines

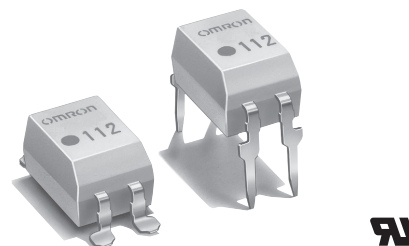

**Note:** The actual product is marked differently from the image shown here.

■ **List of Models**

Contact form	Terminals	Load voltage (peak value)	Model	Number per stick	Number per tape
SPST-NO	PCB terminals	60 VAC	G3VM-61A1	100	---
	Surface-mounting terminals		G3VM-61D1		
				G3VM-61D1(TR)	---

■ **Dimensions**

**Note:** All units are in millimeters unless otherwise indicated.

**G3VM-61A1**

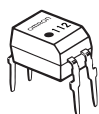

**Note:** The actual product is marked differently from the image shown here.

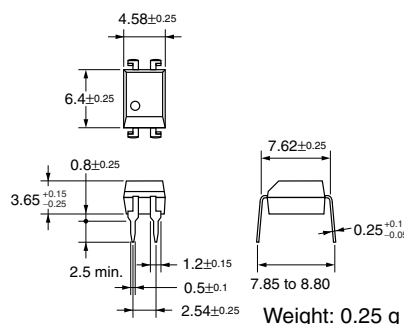

**G3VM-61D1**



**Note:** The actual product is marked differently from the image shown here.

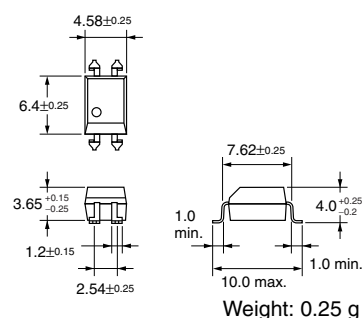

■ **Terminal Arrangement/Internal Connections (Top View)**

**G3VM-61A1**

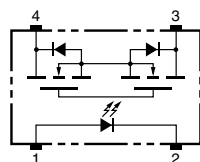

**G3VM-61D1**

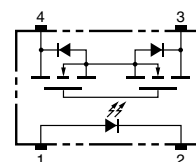

■ **PCB Dimensions (Bottom View)**

**G3VM-61A1**

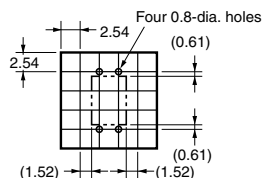

■ **Actual Mounting Pad Dimensions (Recommended Value, Top View)**

**G3VM-61D1**

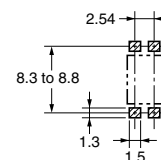

■ Absolute Maximum Ratings (Ta = 25°C)

Item		Symbol	Rating	Unit	Measurement conditions
Input	LED forward current	$I_F$	50	mA	
	Repetitive peak LED forward current	$I_{FP}$	1	A	100 $\mu$ s pulses, 100 pps
	LED forward current reduction rate	$\Delta I_F/^\circ\text{C}$	-0.5	mA/ $^\circ\text{C}$	Ta $\geq$ 25 $^\circ\text{C}$
	LED reverse voltage	$V_R$	5	V	
	Connection temperature	$T_j$	125	$^\circ\text{C}$	
Output	Load voltage (AC peak/DC)	$V_{OFF}$	60	V	
	Continuous load current	$I_O$	500	mA	
	ON current reduction rate	$\Delta I_{ON}/^\circ\text{C}$	-5.0	mA/ $^\circ\text{C}$	Ta $\geq$ 25 $^\circ\text{C}$
	Connection temperature	$T_j$	125	$^\circ\text{C}$	
Dielectric strength between input and output (See note 1.)		$V_{I-O}$	2,500	$V_{rms}$	AC for 1 min
Operating temperature		$T_a$	-40 to +85	$^\circ\text{C}$	With no icing or condensation
Storage temperature		$T_{stg}$	-55 to +125	$^\circ\text{C}$	With no icing or condensation
Soldering temperature (10 s)		---	260	$^\circ\text{C}$	10 s

Note: 1. The dielectric strength between the input and output was checked by applying voltage between all pins as a group on the LED side and all pins as a group on the light-receiving side.

■ Electrical Characteristics (Ta = 25°C)

Item		Symbol	Minimum	Typical	Maximum	Unit	Measurement conditions
Input	LED forward voltage	$V_F$	1.0	1.15	1.3	V	$I_F = 10$ mA
	Reverse current	$I_R$	---	---	10	$\mu\text{A}$	$V_R = 5$ V
	Capacity between terminals	$C_T$	---	30	---	pF	$V = 0$ , $f = 1$ MHz
	Trigger LED forward current	$I_{FT}$	---	1.6	3	mA	$I_O = 500$ mA
Output	Maximum resistance with output ON	$R_{ON}$	---	1	2	$\Omega$	$I_F = 5$ mA, $I_O = 500$ mA
	Current leakage when the relay is open	$I_{LEAK}$	---	0.001	1.0	$\mu\text{A}$	$V_{OFF} = 60$ V
	Capacity between terminals	$C_{OFF}$	---	130	---	pF	$V = 0$ , $f = 1$ MHz
Capacity between I/O terminals		$C_{I-O}$	---	0.8	---	pF	$f = 1$ MHz, $V_s = 0$ V
Insulation resistance		$R_{I-O}$	1,000	---	---	$\text{M}\Omega$	$V_{I-O} = 500$ VDC, $R_{OH} \leq 60\%$
Turn-ON time		$t_{ON}$	---	0.8	2.0	ms	$I_F = 5$ mA, $R_L = 200$ $\Omega$ , $V_{DD} = 20$ V (See note 2.)
Turn-OFF time		$t_{OFF}$	---	0.1	0.5	ms	

Note: 2. Turn-ON and Turn-OFF Times

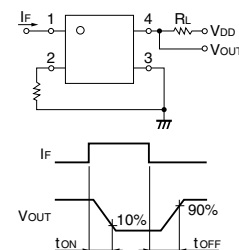

■ Recommended Operating Conditions

Use the G3VM under the following conditions so that the Relay will operate properly.

Item	Symbol	Minimum	Typical	Maximum	Unit
Load voltage (AC peak/DC)	$V_{DD}$	---	---	48	V
Operating LED forward current	$I_F$	5	7.5	25	mA
Continuous load current (AC peak/DC)	$I_O$	---	---	500	mA
Operating temperature	$T_a$	-20	---	65	$^\circ\text{C}$

■ Engineering Data

LED forward current vs. Ambient temperature

$I_F - T_a$

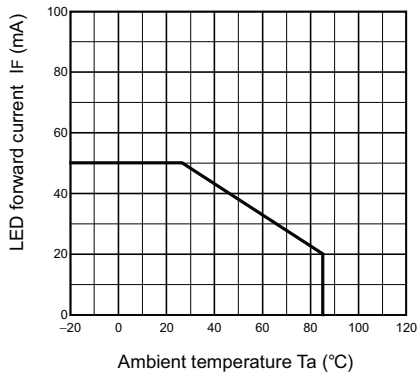

Continuous load current vs. Ambient temperature

$I_O - T_a$

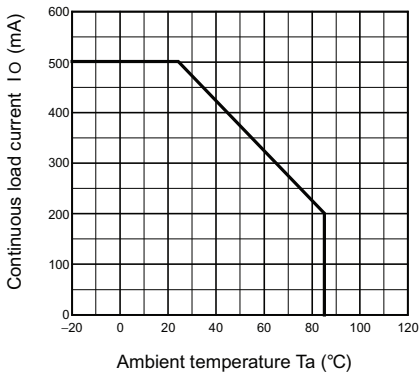

LED forward current vs. LED forward voltage

$I_F - V_F$

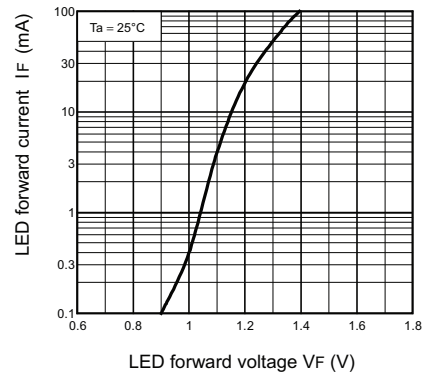

Continuous load current vs. On-state voltage

$I_O - V_{ON}$

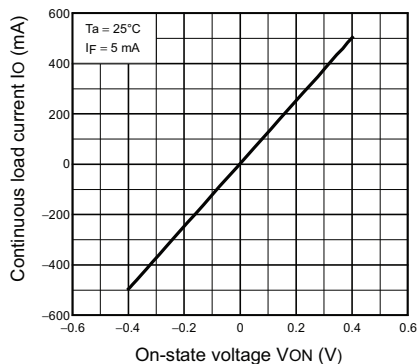

On-state resistance vs. Ambient temperature

$R_{ON} - T_a$

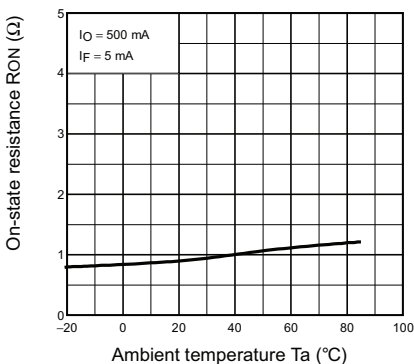

Trigger LED forward current vs. Ambient temperature

$I_{FT} - T_a$

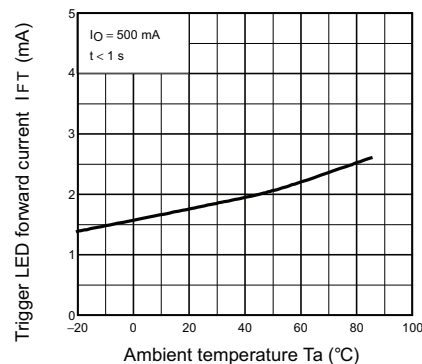

Turn ON, Turn OFF time vs. LED forward current

$t_{ON}, t_{OFF} - I_F$

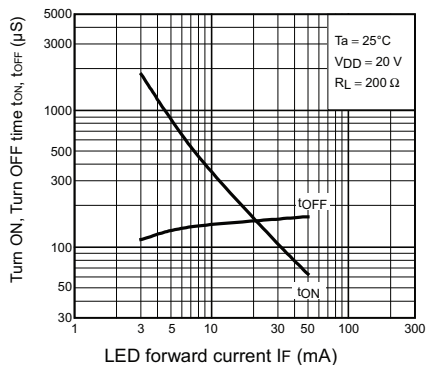

Turn ON, Turn OFF time vs. Ambient temperature

$t_{ON}, t_{OFF} - T_a$

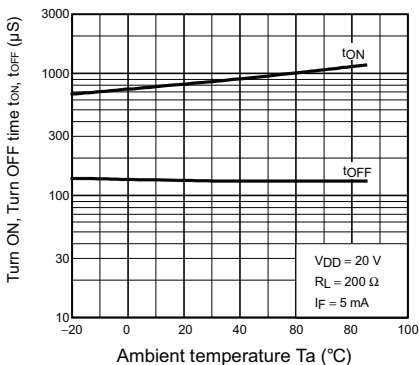

Current leakage vs. Ambient temperature

$I_{LEAK} - T_a$

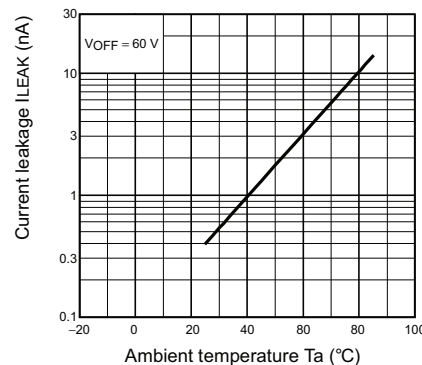

All sales are subject to Omron Electronic Components LLC standard terms and conditions of sale, which can be found at [http://www.components.omron.com/components/web/webfiles.nsf/sales\\_terms.html](http://www.components.omron.com/components/web/webfiles.nsf/sales_terms.html)

**ALL DIMENSIONS SHOWN ARE IN MILLIMETERS.**

To convert millimeters into inches, multiply by 0.03937. To convert grams into ounces, multiply by 0.03527.

---

**OMRON**<sup>®</sup>

**OMRON ELECTRONIC  
COMPONENTS LLC**

55 E. Commerce Drive, Suite B  
Schaumburg, IL 60173

**847-882-2288**

**OMRON ON-LINE**

Global - <http://www.omron.com>

USA - <http://www.components.omron.com>

Cat. No. X302-E-1

12/10

Specifications subject to change without notice

Printed in USA