

## Female cordset

### V1-W-2M-PUR

- Degree of protection IP68 / IP69
- Resistant to microbes and hydrolysis
- Halogen-free
- Specific design protects against loosening and inaccurate installation

Female cordset single-ended M12 angled A-coded, 4-pin, PUR cable grey



## Dimensions

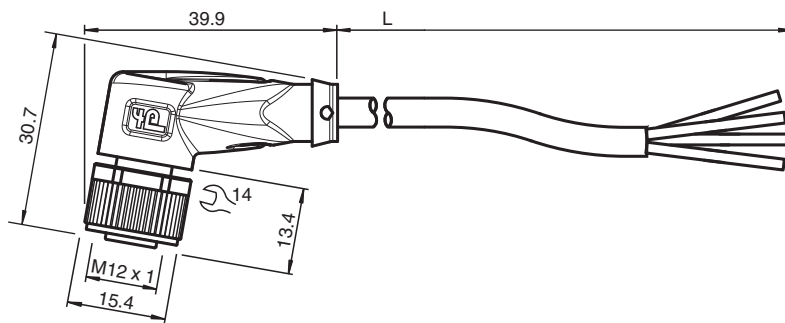

## Technical Data

### General specifications

Connector 1	
Connection	socket
Construction type	M12
Style	angled
Locking	screw connection
Number of pins	4
Coding	A-coded
Connector 2	
Connection	cable end

### Electrical specifications

Operating voltage	$U_B$	max. 250 V AC/DC
Operating current	$I_B$	max. 4 A

### Conformity

Degree of protection	EN 60529
Plug connection	connector M12 x 1 : IEC 61076-2-101
Halogen-free	IEC 60754-1

Release date: 2022-03-20 Date of issue: 2022-03-20 Filename: 109437\_eng.pdf

Refer to "General Notes Relating to Pepperl+Fuchs Product Information".

Pepperl+Fuchs Group  
www.pepperl-fuchs.com

USA: +1 330 486 0001  
fa-info@us.pepperl-fuchs.com

Germany: +49 621 776 1111  
fa-info@de.pepperl-fuchs.com

Singapore: +65 6779 9091  
fa-info@sg.pepperl-fuchs.com

PEPPERL+FUCHS

## Technical Data

Ambient conditions		
Ambient temperature		
Plug connector		-40 ... 90 °C (-40 ... 194 °F)
Cable, fixed		-40 ... 80 °C (-40 ... 176 °F)
Cable, flexing		-25 ... 80 °C (-13 ... 176 °F)
Pollution degree		3
Mechanical specifications		
Plug connector		
Tightening torque		0.6 Nm
Loosening protection		available
Tool installation		straight knurling and hexagon nut SW = 14 mm
Mating cycles		min. 100
Degree of protection		IP68 / IP69
Cable		according to IEC/EN 60228 (DIN VDE 0295) class 5
Sheath diameter		4.8 mm
Bending radius		> 10 x cable diameter, moving > 8 x cable diameter, fixed
Sheath stripping force		max. 60 N / 500 mm
Sheath color		grey (similar to RAL 7001)
Number of cores		4
Core cross section		0.34 mm <sup>2</sup>
Cores color		Core 1: brown Core 2: white Core 3: blue Core 4: black
Core construction		19 x 0.15 mm Ø
Length	L	2 m
Cable code		Li 9Y 11YM 4 x 0.34
Drag chain suitability		
Drag chain cycles		max. 50 / day
Motion velocity		max. 0.3 m/s
Material		
Halogen-free		yes
Plug connector		
Screw connection		Zinc diecast, nickel-plated
Body		TPU, black
Seal		FKM
Contact surface		Au
Flammability		V-2
Cable		
Sheathing		PUR based on polyether
Core insulation		PP
Chemical resistance		good
Microbial resistance		yes
Hydrolysis resistance		yes





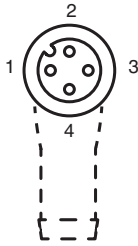

Release date: 2022-03-20 Date of issue: 2022-03-20 Filename: 109437\_eng.pdf

## Connection Assignment



- 1 ) ..... BN
- 2 ) ..... WH
- 3 ) ..... BU
- 4 ) ..... BK

## Accessories

	<b>MH V1-SCREWDRIVER</b>	torque screwdriver (0.6 Nm)
	<b>MH V1-BIT M12</b>	plug-in cap M12
	<b>V1/V3-LABELHOLDER</b>	Label holder
	<b>V1/V3-LABEL</b>	Label plate
	<b>MH V1-Holder</b>	Modular universal holder for M12 connectors
	<b>V1-CLIP</b>	Unlocking protector for M12 connector
	<b>V1-MARKING-RING-COLOR</b>	Marking rings for M12 connectors, various colors

Release date: 2022-03-20 Date of issue: 2022-03-20 Filename: 109437\_eng.pdf

Refer to "General Notes Relating to Pepperl+Fuchs Product Information".