



Description

The SE5167 is an efficient linear voltage regulator. It has extra low dropout voltage. At light loads the typical dropout voltage is 15mV, at full load the typical dropout voltage is 380mV. The output voltage accuracy is better than 2%.

The SE5167 has low ground current at 65uA, so it can help prolong battery life. The SE5167 is specially designed for hand-held, battery-powered devices.

Features

- Typical 175mV dropout voltage at 150mA.
- Low Ground current at 65uA. (Typ.)
- Guaranteed 300mA output over the full operating temperature range.
- Extremely tight load and line regulation.
- Low temperature coefficient.
- Current and thermal limiting.
- No-load stability.
- Available in SOT-23-3L and TO-92 Packages.

Applications

- CD/DVD-ROM, CD/RW
- Wireless LAN card, Keyboard, Mouse
- Battery Powered Equipments
- PCMCIA Card

Ordering/Marking Information

Package	Ordering Information		Marking Information	
<p>TO-92 N-Pinout (Top View)</p>	3.3V	SE5167AHN-LF	SE5167AHN YYWW-LF	YY: year code WW: week code. LF: lead free.
	2.8V	SE5167BHN-LF	SE5167BHN YYWW-LF	
	2.5V	SE5167CHN-LF	SE5167CHN YYWW-LF	
	1.8V	SE5167DHN-LF	SE5167DHN YYWW-LF	
	1.5V	SE5167EHN-LF	SE5167EHN YYWW-LF	
	3.0V	SE5167FHN-LF	SE5167FHN YYWW-LF	
<p>TO-92 G-Pinout (Top View)</p>	3.3V	SE5167AHG-LF	SE5167AHG YYWW-LF	
	2.8V	SE5167BHG-LF	SE5167BHG YYWW-LF	
	2.5V	SE5167CHG-LF	SE5167CHG YYWW-LF	
	1.8V	SE5167DHG-LF	SE5167DHG YYWW-LF	
	1.5V	SE5167EHG-LF	SE5167EHG YYWW-LF	
	3.0V	SE5167FHG-LF	SE5167FHG YYWW-LF	



Ordering/Marking Information (Continued)

Package	Ordering Information		Marking Information	
<p>SOT-23-3L N-Pinout (Top View)</p>	3.3V	SE5167ALN-LF	1 <u>6</u> 7AN [•] ₋	<p>Starting with 1, a bar on top of 1 is for production year 2001, and underlined 1 is for year 2002. The next character is marked on top for 2003, and underlined for 2004. The naming pattern continues with consecutive characters for later years.</p> <p>The last character is the week code. (A-Z: 1-26, a-z: 27-52)</p> <p>A dot on top right corner is for lead-free process.</p> <p>LF: lead free.</p>
	2.8V	SE5167BLN-LF	1 <u>6</u> 7BN [•] ₋	
	2.5V	SE5167CLN-LF	1 <u>6</u> 7CN [•] ₋	
	1.8V	SE5167DLN-LF	1 <u>6</u> 7DN [•] ₋	
	1.5V	SE5167ELN-LF	1 <u>6</u> 7EN [•] ₋	
	3.0V	SE5167FLN-LF	1 <u>6</u> 7FN [•] ₋	
<p>SOT-23-3L G-Pinout (Top View)</p>	3.3V	SE5167ALG-LF	1 <u>6</u> 7AG [•] ₋	
	2.8V	SE5167BLG-LF	1 <u>6</u> 7BG [•] ₋	
	2.5V	SE5167CLG-LF	1 <u>6</u> 7CG [•] ₋	
	1.8V	SE5167DLG-LF	1 <u>6</u> 7DG [•] ₋	
	1.5V	SE5167ELG-LF	1 <u>6</u> 7EG [•] ₋	
	3.0V	SE5167FLG-LF	1 <u>6</u> 7FG [•] ₋	



Absolute Maximum Ratings⁽¹⁾

Supply Input Voltage (VIN)+6V
 Power Dissipation (PD) Internally Limited ⁽³⁾
 Junction Temperature (TJ) 0°C to +125°C
 Lead Temperature (soldering, 5 sec.) 260°C
 Storage Temperature (TS) -40°C to +150°C

Operating Ratings⁽²⁾

Supply Input Voltage (VIN) +2.8V to +6V
 Junction Temperature (TJ) 0°C to +125°C
 Package Thermal Resistance
 160°C/W (TO-92)
 250°C/W (SOT-23-3L)

Electrical Characteristics

V_{IN} = 5V; C_{IN} = 2.2μF; C_{OUT} = 2.2μF (Electrolytic capacitor) ; I_{OUT} = 10mA; T_J = 25°C, unless otherwise specified.

Symbol	Parameter	Conditions	Min	Typ	Max	Units
V _{OUT}	Output Voltage Accuracy	SE5167 – 1.5V(V _{IN} =1.8V,I _{OUT} =1mA)	1.470	1.5	1.530	V
		SE5167 – 1.8V(V _{IN} =3.3V,I _{OUT} =10mA)	1.764	1.8	1.836	
		SE5167-2.5V	2.450	2.5	2.550	
		SE5167-2.8V	2.744	2.8	2.856	
		SE5167-3.0V	2.940	3.0	3.060	
		SE5167-3.3V	3.234	3.3	3.366	
ΔV _{OUT} /ΔT	Output Voltage Temperature Coefficient	Note 4	--	0.025	--	mV/°C
ΔV _{OUT} / V _{OUT}	Line Regulation	V _{IN} = (V _{OUT} +0.8)V or 2.5V to 5.5V	--	1.0	--	%/V
ΔV _{OUT} / V _{OUT}	Load Regulation ⁽⁵⁾	V _{IN} = (V _{OUT} +0.8)V or 2.5V I _{OUT} =1mA to 300mA	--	1.0	--	%
V _{IN} - V _{OUT}	Dropout Voltage ⁽⁶⁾	I _{OUT} =10mA	--	15	--	mV
		I _{OUT} =150mA	--	175	--	
		I _{OUT} =300mA	--	380	--	
T _{PROTECTION}	Thermal Protection	Thermal Protection Temperature	--	150	--	°C
		Protection Hysterisys	--	20	--	°C
PSRR	Ripple Rejection	f =120Hz	--	59	--	dB
I _{GROUND}	Ground Current	I _{OUT} =10mA	--	65	--	uA
I _{LIMIT}	Current Limit	V _{OUT} =0V	--	600	--	mA



Note 1: Exceeding the absolute maximum rating may damage the device.

Note 2: The device is not guaranteed to function outside its operating rating.

Note 3: The maximum allowable power dissipation at any TA (ambient temperature) is calculated using: $P_{D(MAX)} = (T_{J(MAX)} - T_A)/\theta_{JA}$. Exceeding the maximum allowable power dissipation will result in excessive die temperature, and the regulator will go into thermal shutdown. See Table 1 and the "Thermal Considerations" section for details.

Note 4: Output voltage temperature coefficient is the worst-case voltage change divided by the total temperature range.

Note 5: Regulation is measured at constant junction temperature using low duty cycle pulse testing. Parts are tested for load regulation in the load range from 100 μ A to 300mA. Changes in output voltage due to heating effects are covered by the thermal regulation specification.

Note 6: Dropout voltage is defined as the input to output differential at which the output voltage drops 2% below its nominal value measured at 1V differential.

Note 7: The C_{in} or C_{out} should be chosen carefully. Please refer to the Application Hints

Typical Application

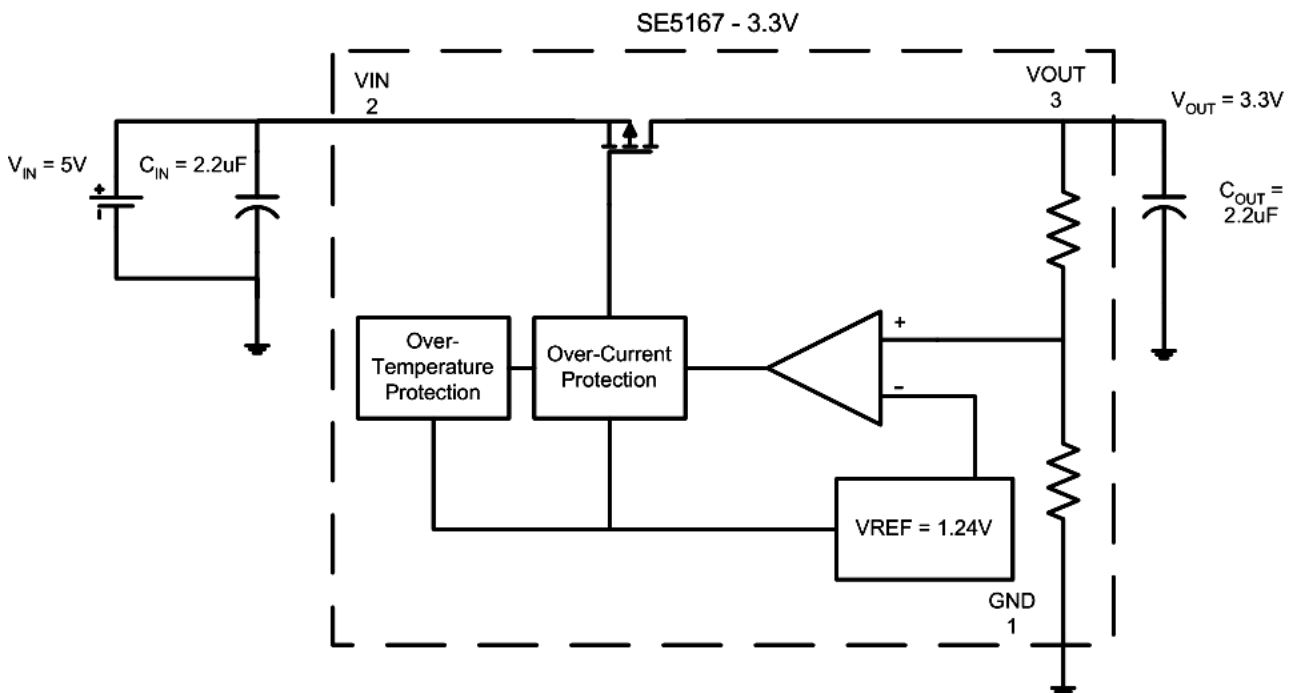



Line Regulation ($V_{OUT} = 3.3V$)
($V_{IN} = 4.3V$ to $6V$, $I_{OUT} = 1mA$)

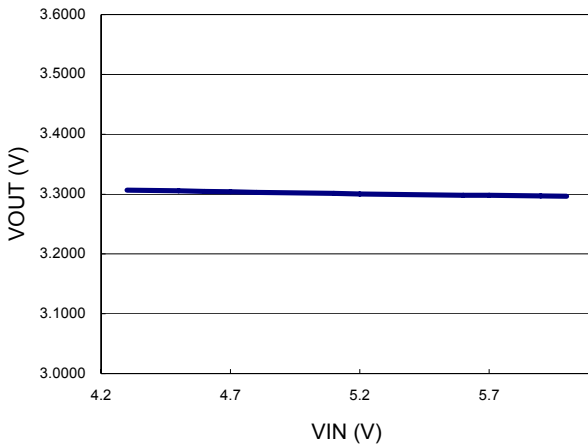

Load Regulation ($V_{OUT} = 3.3V$)
($V_{IN} = 5V$, $I_{OUT} = 1mA$ to $500mA$)

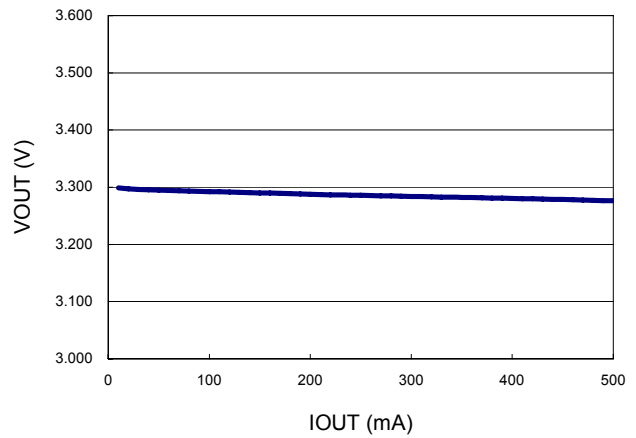

Output Voltage vs Temperature
($V_{IN} = 5V$, $I_{OUT} = 10mA$)

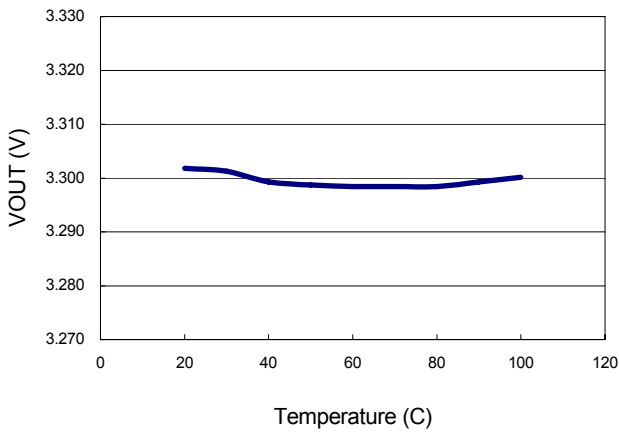

IQ vs IOUT ($V_{OUT} = 3.3V$)
($V_{IN} = 5V$, $I_{OUT} = 10mA$ to $500mA$)

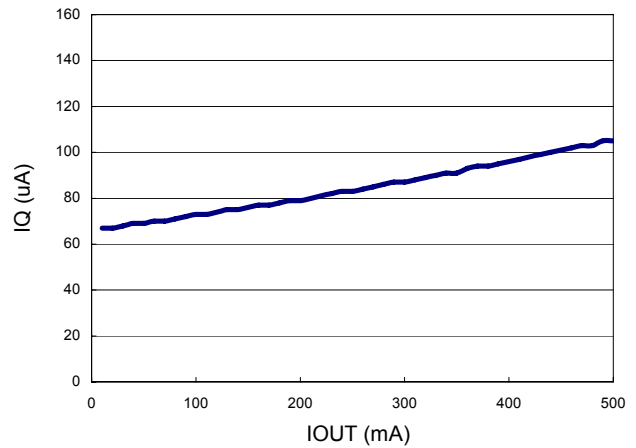

PSRR ($V_{OUT} = 3.3$)
($V_{IN} = 5V$, $V_{PP} = 1V$)

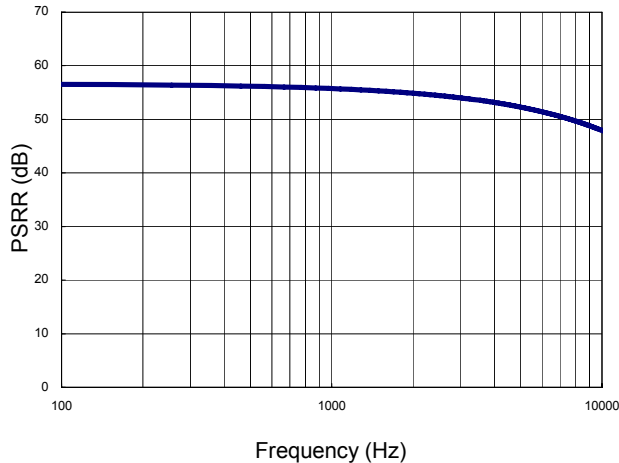

Transient Response ($V_{OUT} = 1.5V$)

($I_{OUT} = 1mA$ to $150mA$)

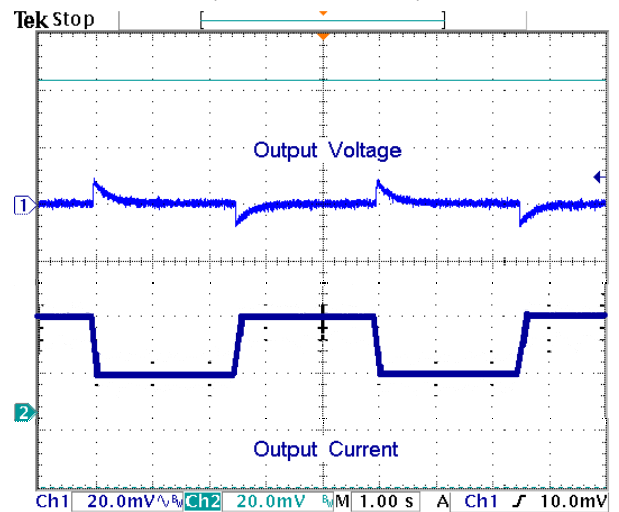



Application Hints

Like any Low dropout regulator, SE5167 requires external capacitors to ensure stability. The external capacitors must be carefully selected to ensure the performances.

Input Capacitor:

An Input Capacitor of at least 2.2uF is required. The inexpensive Electrolytic capacitor is preferred. The value can be increased without upper limit.

Output Capacitor:

An Output Capacitor is required for look stability. It must be located no more than 1cm away from the V_{OUT} pin, and connected directly between V_{OUT} and GND pins. The inexpensive Electrolytic capacitor is recommended. The minimum value is 2.2uF but once again its value can be increased without limit.

Thermal Consideration

It is important that the thermal limit of the package should not be exceeded. The SE5167 has built-in thermal protection. When the thermal limit is exceeded, the IC will enter protection, and the V_{OUT} will be reset to zero. The power dissipation for a given application can be calculated as follows:

The Power Dissipation (P_D) is

$$P_D = I_{OUT} * [V_{IN} - V_{OUT}]$$

The thermal limit of the package is then limited to $P_{D(MAX)} = [T_J - T_A]/\theta_{JA}$ where T_J is the junction temperature, T_A is ambient temperature, and θ_{JA} is around 250°C/W for SE5167. SE5167 is designed to enter thermal protection at 150°C. For example, if T_A is 25°C then the max P_D is limited to about 0.5W. In other words, if $I_{OUT(MAX)} = 300mA$, then $[V_{IN} - V_{OUT}]$ can not exceed 1.67V.



OUTLINE DRAWING SOT-23-3L (SC-59)

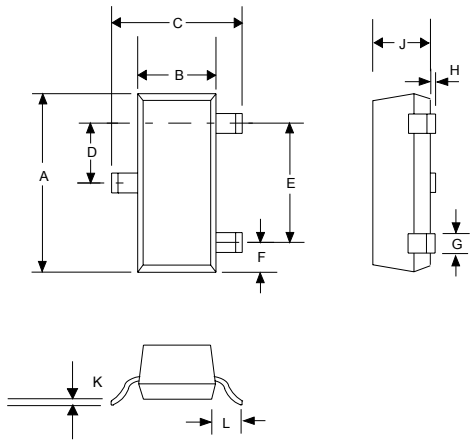

DIM ^N	DIMENSIONS			
	INCHES		MM	
	MIN	MAX	MIN	MAX
A	0.110	0.120	2.80	3.04
B	0.047	0.055	1.20	1.40
C	0.083	0.104	2.10	2.64
D	0.035	0.040	0.89	1.03
E	0.070	0.080	1.78	2.05
F	0.018	0.024	0.45	0.60
G	0.015	0.020	0.37	0.51
H	0.0005	0.004	0.013	0.10
J	0.034	0.040	0.887	1.02
K	0.003	0.007	0.085	0.18
L	-	0.027	-	0.69

OUTLINE DRAWING TO-92

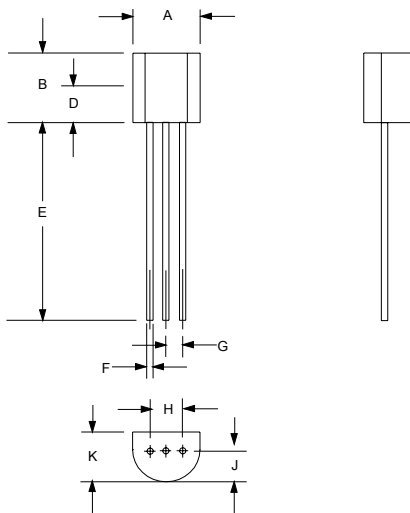

DIM ^N	DIMENSIONS			
	INCHES		MM	
	MIN	MAX	MIN	MAX
A	0.175	0.205	4.445	5.207
B	0.170	0.210	4.318	5.334
E	0.500	0.610	12.70	15.50
F	0.016	0.021	0.407	0.533
G	0.045	0.055	1.143	1.397
H	0.095	0.105	2.413	2.667
J	0.080	0.105	2.032	2.667
K	0.125	0.165	3.175	4.191



Customer Support

Seaward Electronics Incorporated – China

Section B, 2nd Floor, ShangDi Scientific Office Complex, #22 XinXi Road

Haidian District, Beijing 100085, China

Tel: 86-10-8289-5700/01/05

Fax: 86-10-8289-5706

Seaward Electronics Corporation – Taiwan

2F, #181, Sec. 3, Minquan East Rd,

Taipei, Taiwan R.O.C

Tel: 886-2-2712-0307

Fax: 886-2-2712-0191

Seaward Electronics Incorporated – North America

1512 Centre Pointe Dr.

Milpitas, CA95035, USA

Tel: 1-408-821-6600

Last Updated - 12/5/2008