

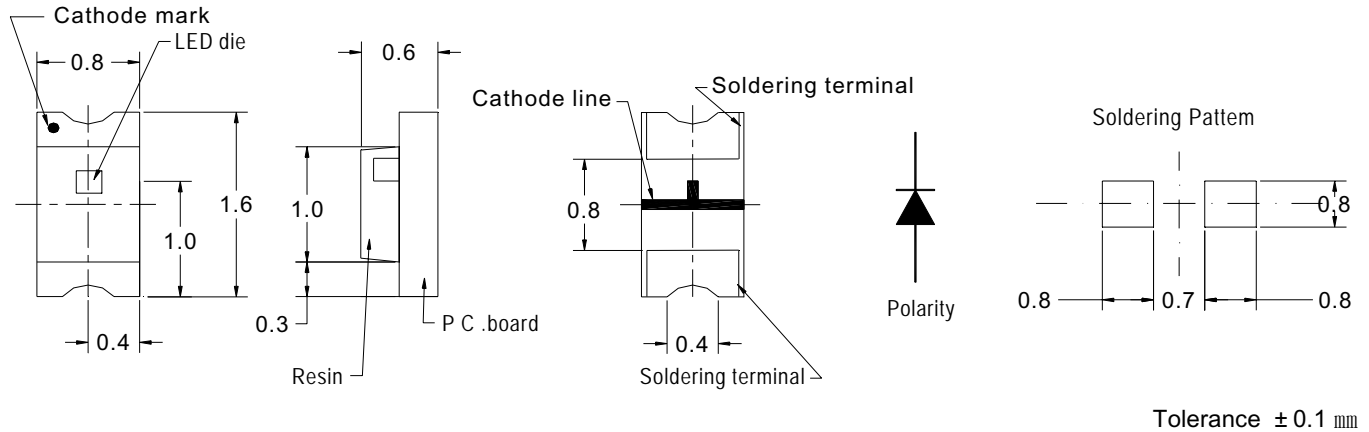

BVS-166RT2

PACKAGE CONFIGURATION



DESCRIPTION

Dice Material : AlGaInP/GaAs Orange Red
 Light Color : Orange Red Color
 Lens Color : Milky Diffused

ABSOLUTE MAXIMUM RATINGS AT Ta = 25 °C

PARAMETER	MAX.	UNIT
Power Dissipation	55	mW
Continuous Forward Current	20	mA
Peak Forward Current (1/10 Duty Cycle , 0.1ms Pulse Width)	100	mA
Reverse Voltage	5	V
Derating Linear From 25 °C	0.35	mA/°C
Operating Temperature Range	-30 to + 80	°C
Storage Temperature Range	-40 to + 85	°C
Infrared Soldering Condition 260 °C for 5 seconds		
Reflow Soldering Condition 230 °C for 10 seconds		

ELECTRICAL / OPTICAL CHARACTERISTICS AT Ta = 25 °C

SYMBOL	PARAMETER	TEST COND.	MIN.	TYP.	MAX.	UNIT
V _F	Forward Voltage	I _F = 20 mA		2.1	2.6	V
I _R	Reverse Current	V _R = 5V			100	μA
λ _p	Peak Emission Wavelength	I _F = 20 mA		645		nm
λ _d	Dominant Wavelength	I _F = 20 mA		632		nm
2θ _{1/2}	Viewing Angle	I _F = 20 mA		130		Deg

BIN GRADE LIMITS (I F = 20 mA) LUMINOUS INTENSITY / mcd

Bin	u	v	w	x	y	z
Min.	22	28	36	47	60	78
Max.	28	36	47	60	78	100

Tolerance ± 15% mcd

*Bright View reserves the rights to alter specifications and remove availability of products at any time without notice.

*Dominant Wavelength, λ_d is according to CIE Chromaticity Diagram base on color of lamps.

*θ_{1/2} is the off-axis angle where the luminous intensity is one half the on-axis intensity.



BVS-166RT2

AlGaInP GaAs Orange Red LED

TYPICAL ELECTRICAL / OPTICAL CHARACTERISTIC CURVES

FIG. 1 Forward Current vs. Forward Voltage
($T_a = 25^\circ\text{C}$)

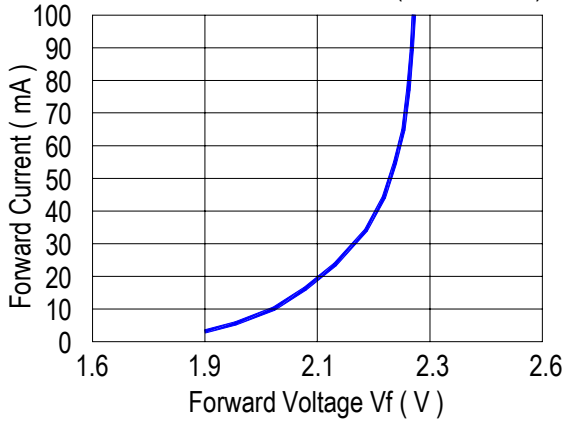

FIG. 2 Relative Intensity vs. Forward Current
($T_a = 25^\circ\text{C}$)

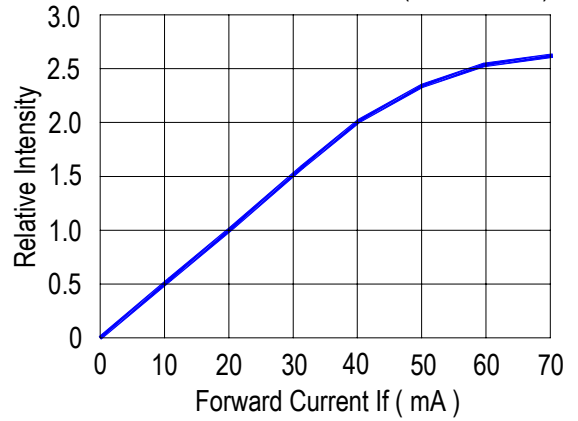

FIG. 3 Forward Voltage vs. Temperature

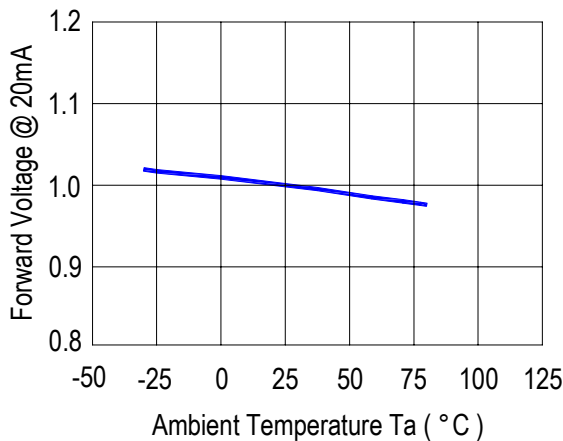

FIG. 4 Relative Intensity vs. Temperature

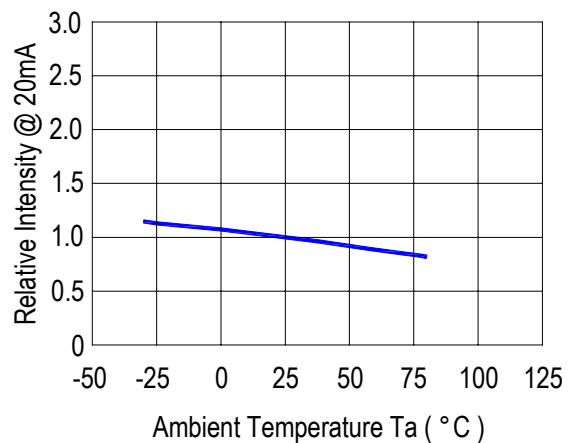

FIG. 5 Relative Intensity vs. Wavelength (λ_p)
($T_a = 25^\circ\text{C}$)

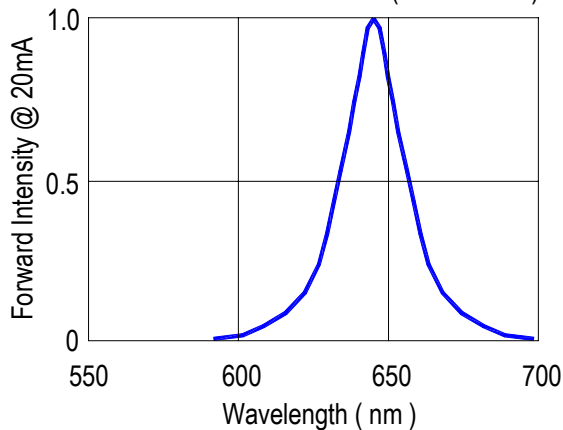
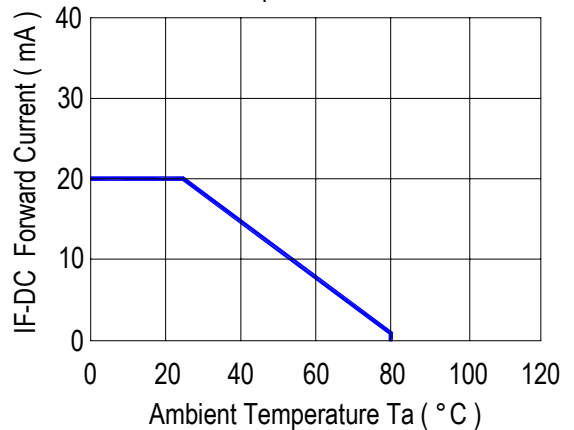

FIG. 6 Maximum Forward Current
vs. Temperature





Apply to BVS-3XX 、 1XX series.

Description:

(1) Manual soldering (We do not recommend this method strongly.)

- (1.1) To prevent cracking, please bake (65°C, 24hrs) before soldering.
- (1.2) Temperature at tip of iron: 250°C Max. (25W)
- (1.3) It's banned to load any stress on the resin during soldering.
- (1.4) Soldering time: 3 sec. Max. (one time only)

(2) Reflow Soldering

- (2.1) To prevent cracking, please bake (65°C, 24hrs) before soldering.
- (2.2) When soldering, do not put stress on the LEDs during heating.
- (2.3) Never take next process until the component is cooled down to room temperature after reflow.
- (2.4) After soldering, do not warp the circuit board.
- (2.5) The recommended reflow soldering profile (measuring on the surface of the LED resin) is following:

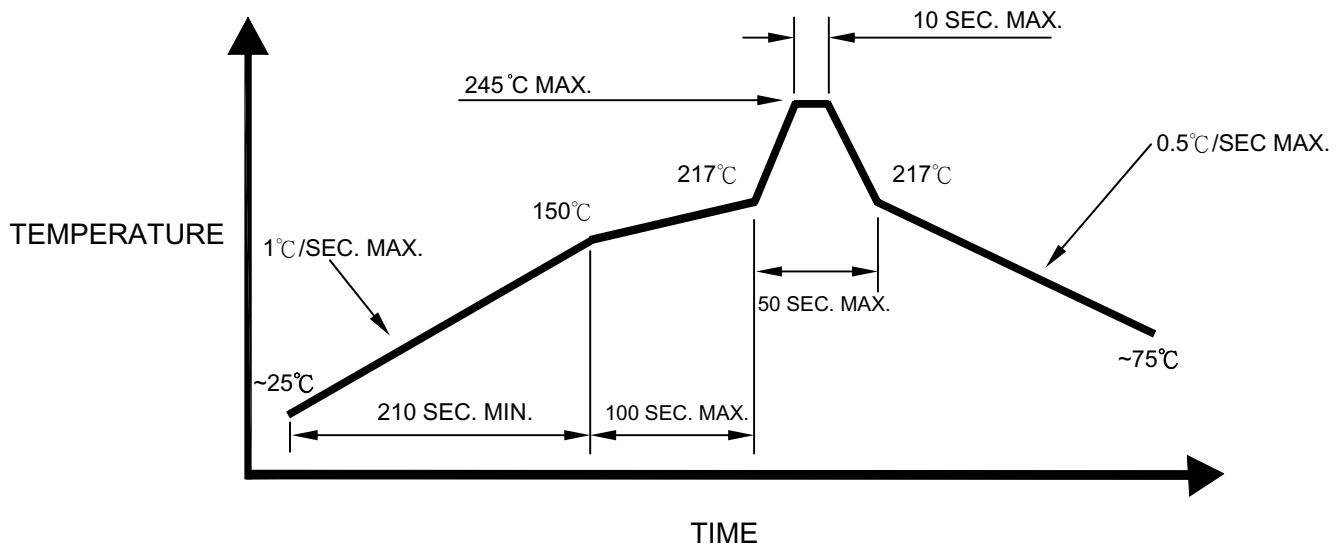

The reflow temperature 240°C~245°C is recommended and the soldering temperature should be not higher than 245°C (one time only)



BVS-166/167 Series

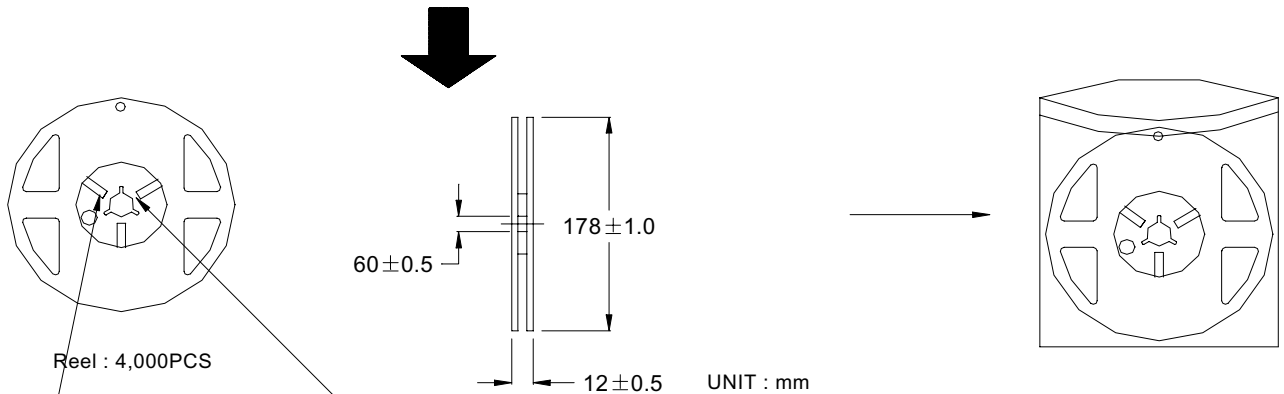
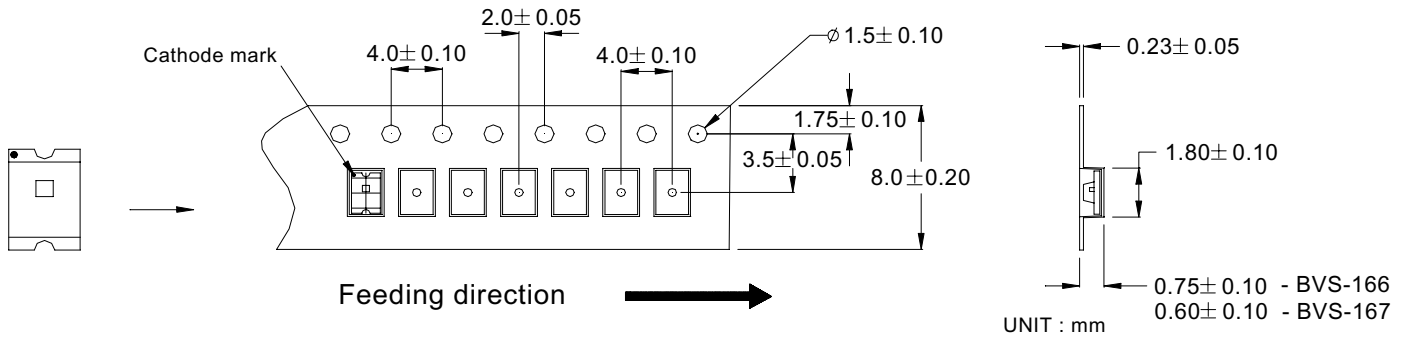

Label 1

Bright View Electronics Co.,Ltd.

PART NO.: BVS-16XXXX

LOT NO.: _____

GRADE: X - △ - ■

Q'ty _____ pcs QA

Label 2

Bright View Electronics Co.,Ltd.

PART NO.: _____

LOT NO.: _____

GRADE: _____

Q'ty _____ pcs QA

CAUTION
ELECTROSTATIC SENSITIVE DEVICES
DO NOT OPEN OR HANDLE EXCEPT
AT A STATIC-FREE WORKSTATION

Normal
X: Bin grade
△: Wavelength
■: Vf

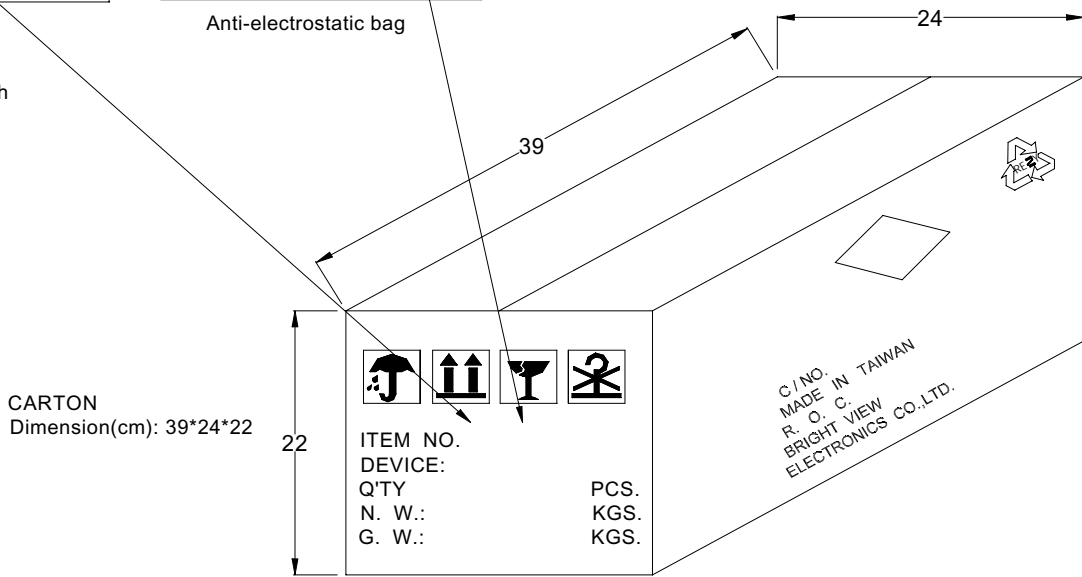

Carton : 30 Reels
Total : 120,000PCS