

**450-3078 Stackable socket, .025 (0,64) pin and socket, for patch lead ends.**

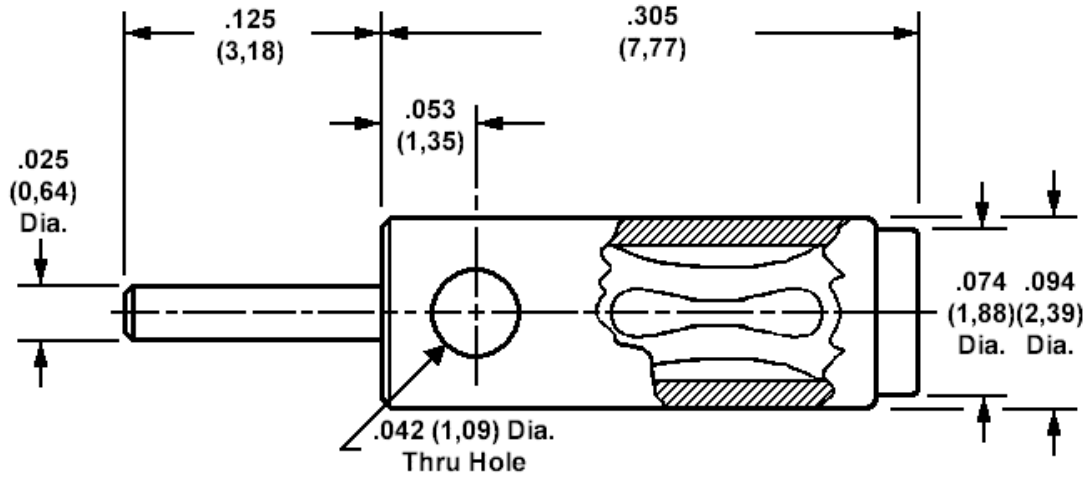

Min hole depth .144 (3,68)

**How to order code**  
**450-3078-01-03-00**

Component	Material	Finish(-03)
Body	Brass	Gold over Nickel
Spring	Beryllium copper	Gold over Nickel

Recommended hook up wire size is 22 AWG (7 strands of 30AWG) copper wire PTFE insulated, .053 (1,37) over insulation. (not supplied)