

MPU-400D Series

Dual Output 400W Power Factor Corrected AC/DC Power Supplies



Key Features:

- Compact 400W Supply
- PFC to EN 61000-3-2 "D"
- EN 60950 Approved (UL)
- CE Certified
- FCC Class B Emissions
- Universal AC Input
- Four Package Options
- 700W Peak Power



MicroPower Direct

292 Page Street
Suite D
Stoughton, MA 02072
USA

T: (781) 344-8226
F: (781) 344-8481
E: sales@micropowerelect.com
W: www.micropowerelect.com



Electrical Specifications

Specifications typical @ +25°C, nominal input voltage & rated output current, unless otherwise noted. Specifications subject to change without notice.

Input

Parameter	Conditions	Min.	Typ.	Max.	Units
Input Voltage Range	Universal	90		264	VAC
Input Frequency		47		63	Hz
Input Current, Full Load	90 VAC		8.5		A
Inrush Current, Cold Start	230 VAC			70	A
Leakage Current, See Note 1	264 VAC			3.5	mA
Power Factor Correction	Meets EN61000-3-2 Class D				
Input Protection	T8A/250V Fuse Inserted In Primary				
Input Undervoltage Protection	Under 80 VAC (±10 VAC) Unit Shuts Down; Unit Recovers Over 90 VAC				

Output

Parameter	Conditions	Min.	Typ.	Max.	Units
Output Voltage Adjustment	By Trim Pot, U-Channel Model Only		±5.0		%
Output Regulation, See Note 2			±1.0		%
Hold Time	115 VAC, 75% Load	16			mSec
Ripple & Noise (20 MHz), See Note 3	See Model Selection Guide				
Overload Protection	Foldback Circuit, Autorecovery	110		140	%
Over Voltage Protection	>130% of Rated Output Voltage. Recycle AC Input.				
Over Temperature Protection	Autorecovery	+105	+110	+115	°C
Temperature Coefficient			±0.04		%/°C
Transient Recovery Time, See Note 5	50% Load Change		2.5		mS
Transient Response Deviation			5.0		%
Overshoot/Undershoot	At Turn On/Off			±5.0	%
Turn On Delay	115 VAC			1.5	S
Output Short Circuit	Continuous With Autorecovery				

General

Parameter	Conditions	Min.	Typ.	Max.	Units
Isolation Voltage, See Note 6	Input - Output	3,000			VAC
	Input - FG (Frame Ground)	1,500			
	Primary - Core	1,500			
Switching Frequency	Fixed		55		kHz

Environmental

Parameter	Conditions	Min.	Typ.	Max.	Units
Operating Temperature Range	Ambient	0	+25	+50	°C
Output Derating		2.5%/°C from +50 °C to +70 °C			
Storage Temperature Range		-20		+80	°C
Cooling	See Model Selection Guide				
Operating Humidity	RH, Non-condensing			90	%

EMI Characteristics

Parameter	Standard	Criteria	Level
Radiated Emissions	EN 55022		B
Conducted Emissions	EN 55022		B
ESD	EN 61000-4-2	A	±4 kV Contact
RS	EN 61000-4-3	A	3V/m
EFT	EN 61000-4-4	A	±1 kV
Surge	EN 61000-4-5	A	±1 kV (L-L), ±2 kV (L-G)
CS	EN 61000-4-6	A	3V/rms
PFM	EN 61000-4-8	A	1A/m
Voltage Dips	EN 61000-4-11	A	>95% 10 mS, 30% 500 mS
		B	>95%, 500 mS

Reliability Specifications

Parameter	Conditions	Min.	Typ.	Max.	Units
MTBF	MIL HDBK 217F, 30°C, Gnd Benign	100			kHours
Safety Standards	UL 60950, EN 60950				
Vibration	Sinusoidal 5~50 Hz, Acceleration ±7.35 m/s ² on X, Y & Z Axis				

www.micropowerelect.com

Model Number	Output Voltage Factory	Output Current With 26.85 CFM (Max A)	Max. Output Power (W)	Regulation (Note 3)	Ripple & Noise (Note 2)	Efficiency (Note 6)	
MPU-400D-0512YYZ	V1	+5 VDC	30.00A	400	±5.0%	1.0%	80%
	V2	+12 VDC	20.83A				
MPU-400D-0524YYZ	V1	+5 VDC	30.00A	400	±5.0%	1.0%	80%
	V2	+24 VDC	10.42A				
MPU-400D-0548YYZ	V1	+5 VDC	30.00A	400	±5.0%	1.0%	80%
	V2	+48 VDC	5.21A				
MPU-400D-1224YYZ	V1	+12 VDC	20.83A	400	±5.0%	1.0%	80%
	V2	+24 VDC	10.42A				

Some models may require a minimum order quantity. Contact the factory for details at: sales@micropowerdirect.com

Notes:

- Units are available with the leakage current specified at 500 µA max. Contact the factory for more information.
- Output regulation includes line & load.
- Ripple & noise is measured from 10 Hz to 20 MHz. Connection to the unit is made with a 0.1 µF ceramic capacitor & a 22 µF electrolytic capacitor connected in parallel.
- A 1% minimum load is required to maintain regulation & ripple specifications.
- Transient recovery is measured to within a 1% error band for a load step change of 50% to 100%.
- Isolation specifications are production HI-Pot tested for 3 seconds.
- The full output range (see table) is covered in the safety agency certification. Standard models are factory set to the Preset voltage, but may be set to other levels within the range without affecting the agency certification. For more information, contact the factory.
- Output power is given for the factory preset voltage. The maximum continuous output power level is 400W with 26.85 CFM airflow. All models provide a peak power level of 700W for a maximum duration of 500 µS. For more information, contact the factory.
- Each unit includes an input fuse (250V/8A). Since this fuse is not field replaceable, it is recommended that an external fuse of the same size be used on the input of the power supply for protection.
- The Fan Drive output (at connector CN4) provides 12V/300 mA to drive an external fan.

Model Number

MPU-400D-XXXXYYZ

Mechanical Configuration
U = U-Chassis

Outputs
S = Single
D = Dual

Output Voltage Selection

Output Connector
A = Molex
T = Terminal Block

Input Connector
A = Molex
T = Terminal Block

Case Options (If Available)
Blank = No Fan
C = Cover
E = End Fan
F = Top Fan

Connections

Input Connector (CN1):

- Terminal Block:
Howder HD-121-7P: M3.5 Screws
7 terminals, 9.5 mm Centers

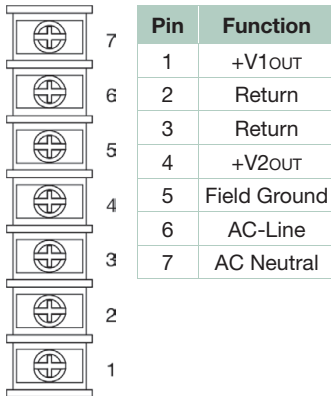

Input Connector (CN1):

- JST Mating Part No:
JST VHR5N or equivalent
(7 pins, 2 pins removed)

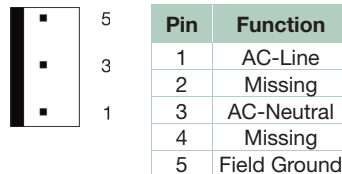

Output Connector (CN2):

- JST Mating Part No:
JST VHR10N or equivalent
(two pins removed)

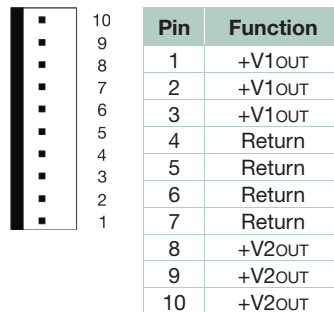

Logic Signal Connector (CN3):

- Mating Part No:
JST XHP-4 or equivalent
(CHYAO SHIUNN JS-1001-04)
Mating Pin No:
JST SXH-002T-PO.6 for AWG 30 to 26

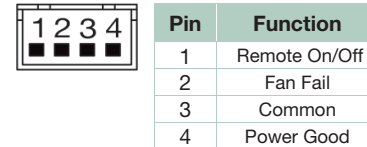

Interface Signals

Power Supply On	Bi-color LED Is green for "power on"; orange when protection enabled
Fan Fail	An open collector output rated for 15V/5 mA sink current maximum. Goes high if a fan failure is detected
Power Good Signal	Goes TTL high 100 to 500 mS after regulation. Goes low at least 1 mS before the loss of regulation. Will sink 100 mA.
Remote On/Off	A TTL low signal inhibits the output. Hiccup mode.

Fan Driver Connector (CN4):

- Mating Part No:
JST XHP-2 or equivalent
(CHYAO SHIUNN JS-2001-2)

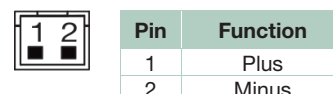

Mechanical Dimensions

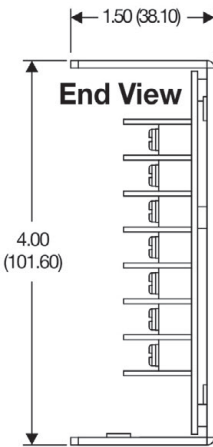
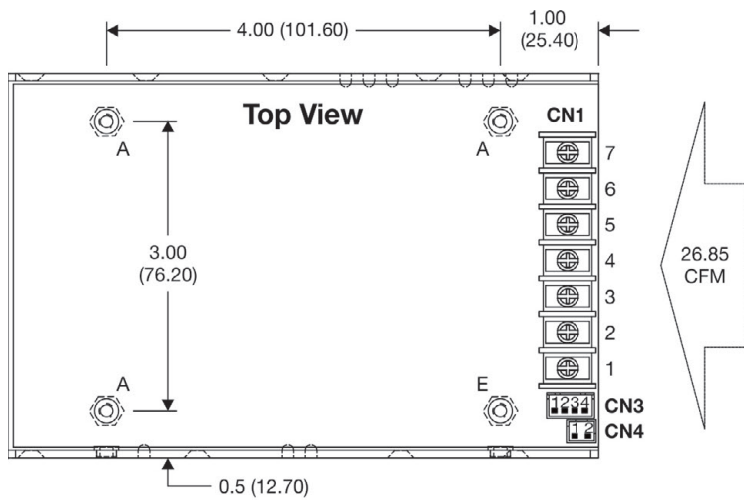

Notes:

- All dimensions are typical in inches (mm)
- Tolerance x.xx = ±0.02 (±0.50)

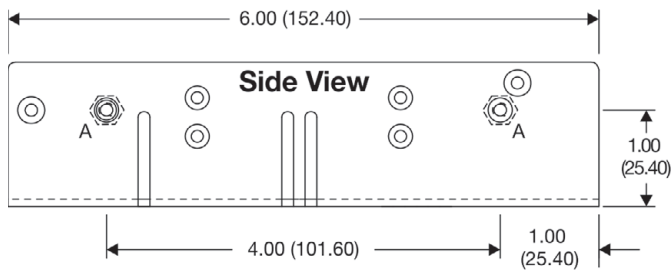

(A): 5 x (M4 x 0.7)

(E): ZN Plated
1 x (M4 x 0.7)

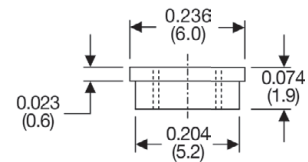
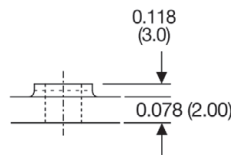

Mounting Inserts

Mechanical Dimensions, Top Fan "F" Models

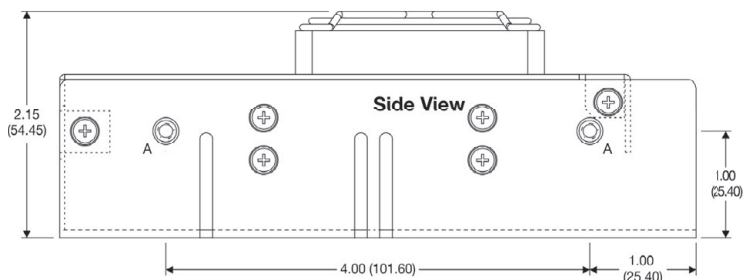
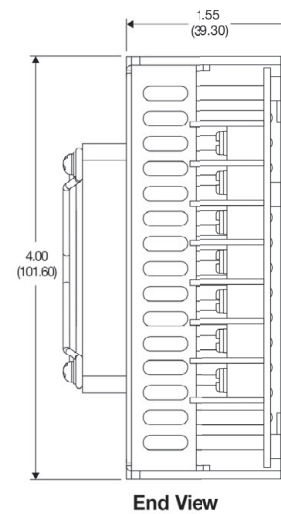
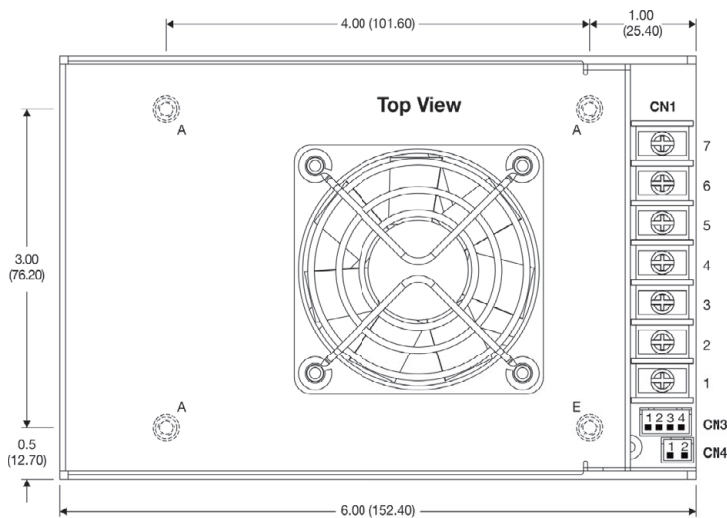

(A): 5 x (M4 x 0.7)

(E): ZN Plated
1 x (M4 x 0.7)

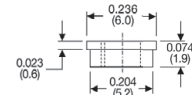
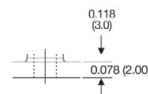

Notes:

- All dimensions are typical in inches (mm)
- Tolerance x.xx = ±0.02 (±0.50)

Mechanical Dimensions, End Fan "E" Models

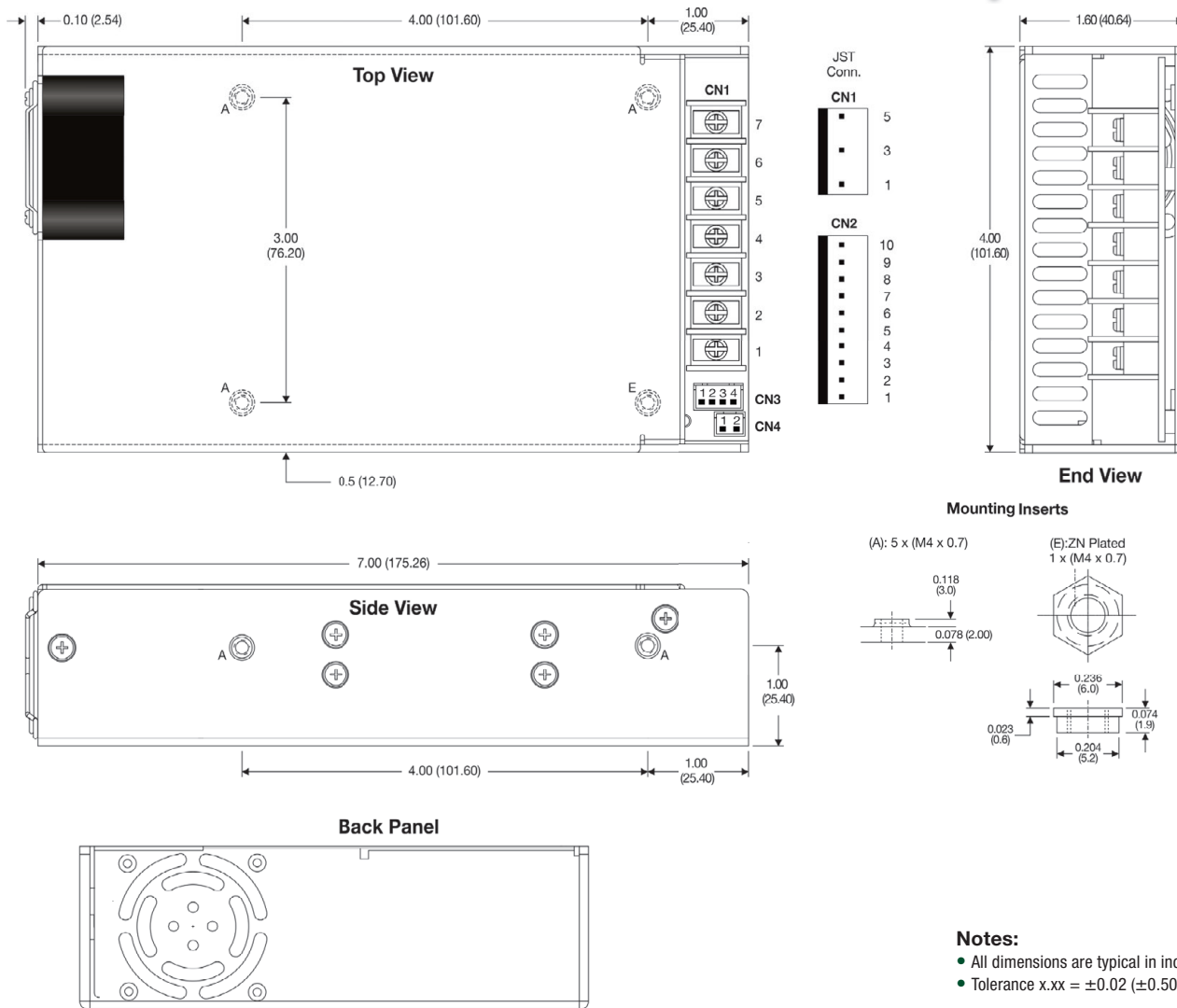

Mechanical Dimensions, "Finger Safe" Cover "C" Models

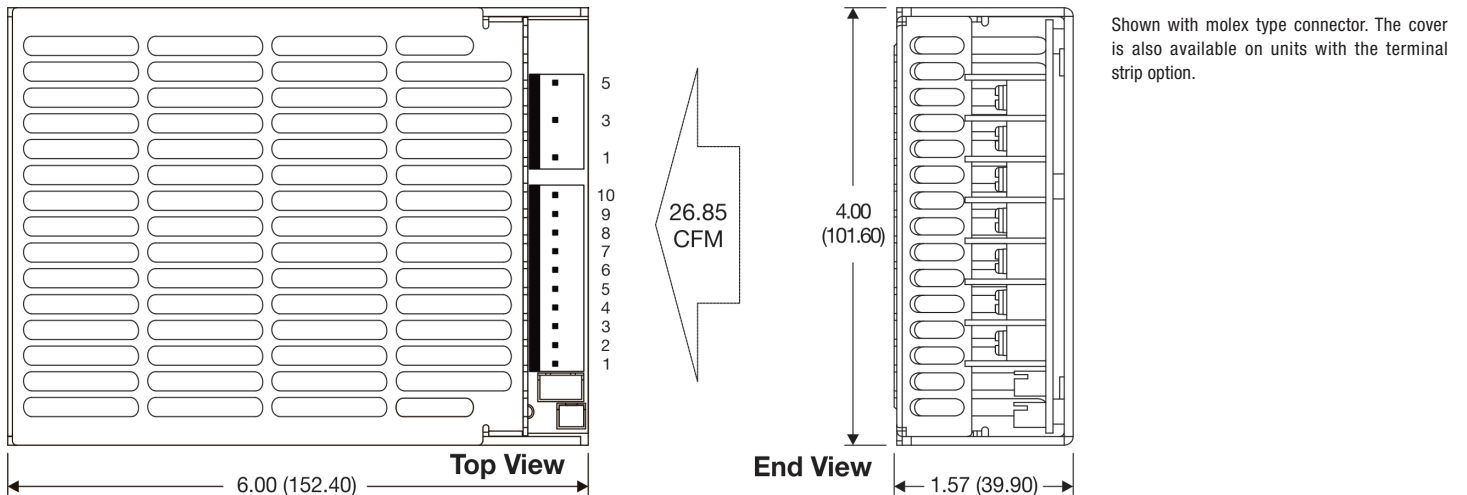

MicroPower Direct
We Power Your Success - For Less!

292 Page Street Ste D Stoughton, MA 02072 • TEL: (781) 344-8226 • FAX: (781) 344-8481 • E-Mail: sales@micropowerdirect.com

Notes:

- All dimensions are typical in inches (mm)
- Tolerance x.xx = ±0.02 (±0.50)