

1 2 3 4 5 6 7 8

REV.	ECN NO./DESCRIPTION	DATE
8	N150637	12/10'15
8A	R160606	06/27'17
9	N170379	07/27'17

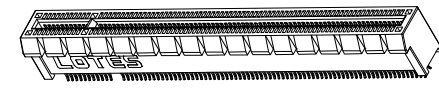
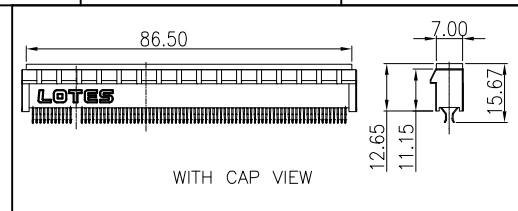

3D VIEW

- NOTES:
- MATERIAL:
HOUSING:HIGH TEMPERATURE THERMOPLASTIC(SEE TABLE)
TERMINAL:PHOSPHOR BRONZE(SEE TABLE)
 - FINISH:
TERMINAL: 50u" NI PLATING OVER ALL;
100u" MATTE Sn PLATING ON SOLDER TAIL;
GOLD PLATING ON CONTACT AREA.
 - MECHANICAL SPEC:
DURABILITY : 50 MATING CYCLES.
RETENTION FORCE : 0.40 kgf MIN PER PIN.
MATING FORCE : 1.15N MAX PER PIN.
UNMATING FORCE : 0.15N MIN PER PAIR.
 - ELECTRICAL SPEC:
CURRENT RATING: 1.1A.
CONTACT RESISTANCE: 30 MILLIOHMS MAX. INITIAL.
INSULATION RESISTANCE: 1000 MEGOHMS MIN.
DIELECTRIC WITHSTANDING VOLTAGE: 500V AC MIN.
 - IR REFLOW:
THE TEMPERATURE SHALL BE 260+/-5°C MAINTAINING 10+/-2 SECONDS
 - RoHS COMPLIANT OR HALOGEN FREE COMPLIANT.
 - PRODUCT NUMBER NOTE:
AAA - PCI - *** - K**

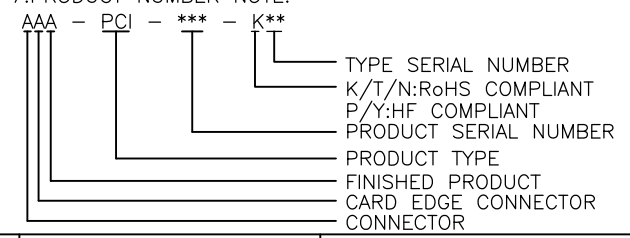
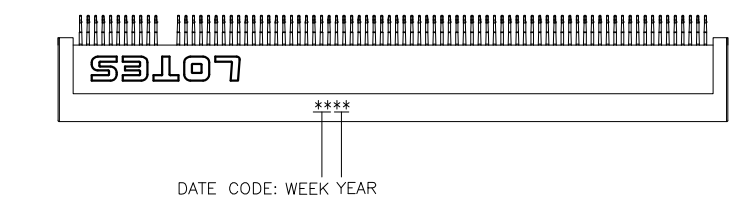
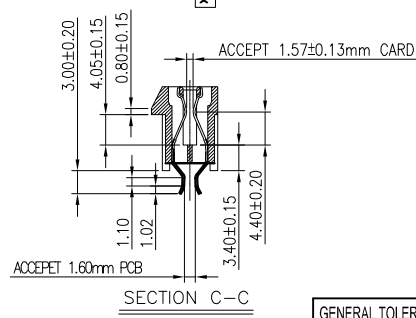
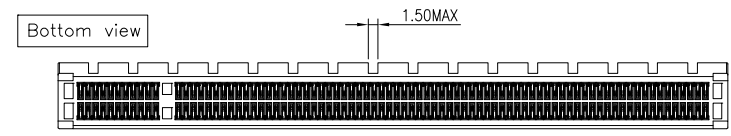
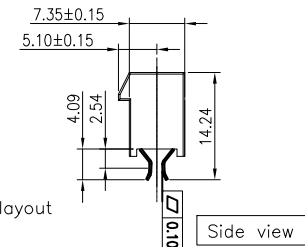
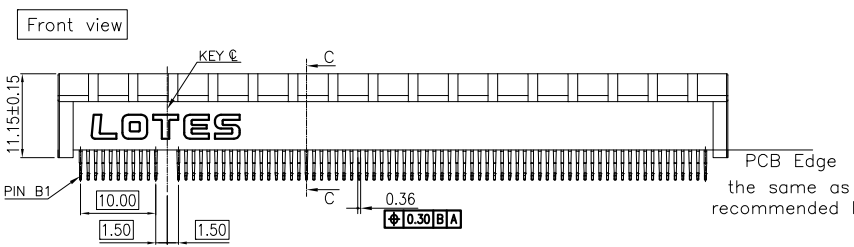
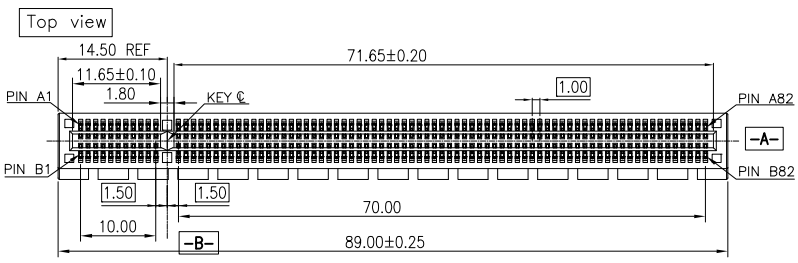

GENERAL TOLERANCES UNLESS SPECIFIED		PART NO.	LOTES		
.X± 0.35	X°± 3°	SEE TABLE	TITLE 164PIN PCI EXPRESS CONNECTOR		
.XX± 0.25	.X°± 2°	APPROVED BY YINJIAXU 07/27'17	DWG NO. GAP-AAA-PCI-014		
.XXX± 0.15	.XX°± 1°	CHECKED BY MARK 07/27'17	DRAWN BY WUYAO 07/27'17		
CUSTOMER DRAWING		DRAWN BY WUYAO 07/27'17		SHEET 1 / 2	
SIZE A4	UNITS MM[INCH]	DRAWN BY WUYAO 07/27'17		SCALE 1:1	REV 9

1 2 3 4 5 6 7 8

F
E
D
C
B
A

F
E
D
C
B
A

REV.	ECN NO./DESCRIPTION	DATE
8	N150637	12/10'15
8A	R160606	06/27'17
9	N170379	07/27'17

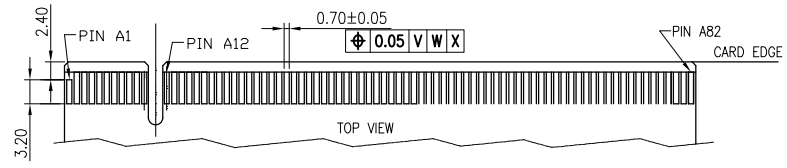
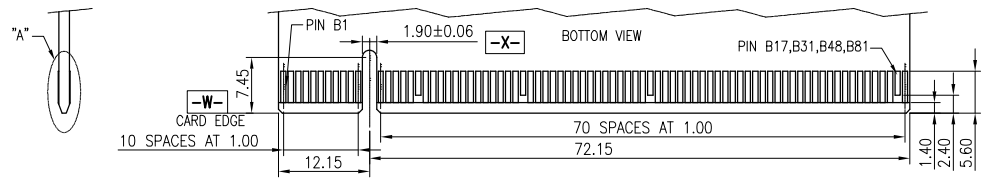

ADD-IN CARD EDGE-FINGER DIMENSIONS
 DEFAULT TOLERANCE ±0.05

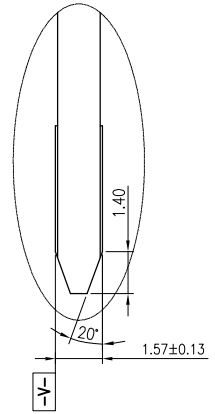

DETAIL "A"
 SCALE 4:1

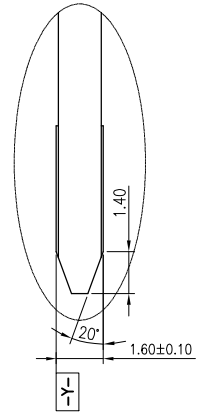

DETAIL "B"
 SCALE 4:1

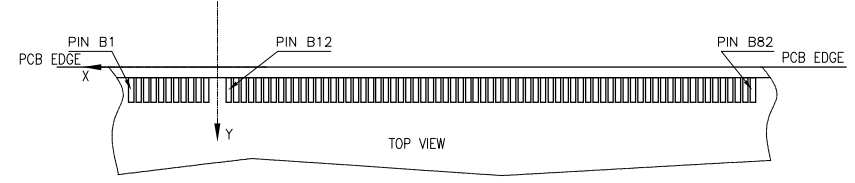
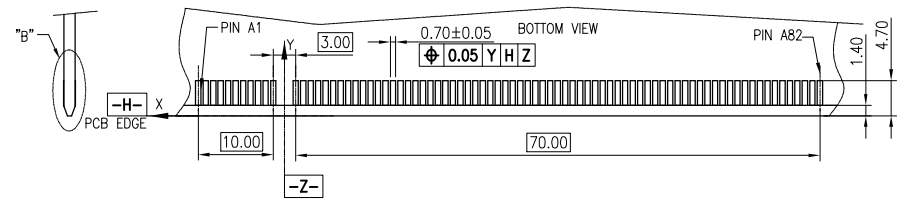

RECOMMENDED FOOTPRINT
 DEFAULT TOLERANCE ±0.05

GENERAL TOLERANCES UNLESS SPECIFIED		PART NO.	LOTES			
X ± 0.35	X° ± 3°	SEE TABLE				
.XX ± 0.25	.X° ± 2°	APPROVED BY	TITLE			
.XXX ± 0.15	.XX° ± 1°	YINJIAXU 07/27'17	164PIN PCI EXPRESS CONNECTOR			
CUSTOMER DRAWING		CHECKED BY	DWG NO.			
		MARK 07/27'17	GAP-AAA-PCI-014			
SIZE	UNITS	DRAWN BY		SHEET	SCALE	REV
A4	MM[INCH]	WUYAO 07/27'17				

NO.	PART NUMBER	HOUSING	TERMINAL
1	AAA-PCI-014-K06	PA9T+30%GF_BLACK;UL94 V-0	PHOSPHOR BRONZE_C5191_G/F
2	AAA-PCI-014-K15	PA9T+30%GF_BLACK;UL94 V-0	PHOSPHOR BRONZE_C5191_G/F