



ON Semiconductor®

FPF2280 Over-Voltage Protection Load Switch

Features

- Surge Protection
 - IEC 61000-4-5: > 100 V
- Over-Voltage Protection (OVP)
- Over-Temperature Protection (OTP)
- ESD Protection
 - Human Body Model (HBM): > 3.5 kV
 - Charged Device Model (CDM): > 2 kV
 - IEC 61000-4-2 Air Discharge: > 15 kV
 - IEC 61000-4-2 Contact Discharge: > 8 kV

Applications

- Mobile Handsets and Tablets
- Portable Media Players
- MP3 Players

Description

The FPF2280 features a low- R_{ON} internal FET and an operating range of $2.5 V_{DC}$ to $5.5 V_{DC}$ (absolute maximum of $29 V_{DC}$). An internal clamp is capable of shunting surge voltages >100 V, protecting downstream components and enhancing system robustness. The FPF2280 features over-voltage protection that powers down the internal FET if the input voltage exceeds the OVP threshold. The OVP threshold is adjustable with optional external resistors. Over-temperature protection also powers down the device at $130^{\circ}C$ (typical). Exceptionally low off-state current (<1 μA maximum) facilitates compliance with standby power requirements.

The FPF2280 is available in a fully “green” compliant $1.3 \text{ mm} \times 1.8 \text{ mm}$ Wafer-Level Chip-Scale Package (WLCSP) with backside laminate.

Related Resources

- <http://www.onsemi.com/>

Ordering Information

Part Number	Operating Temperature Range	Top Mark	Package	Packing Method
FPF2280BUCX-F130	-40°C – 105°C	HC	12-Ball, 0.4 mm Pitch WLCSP	Tape & Reel

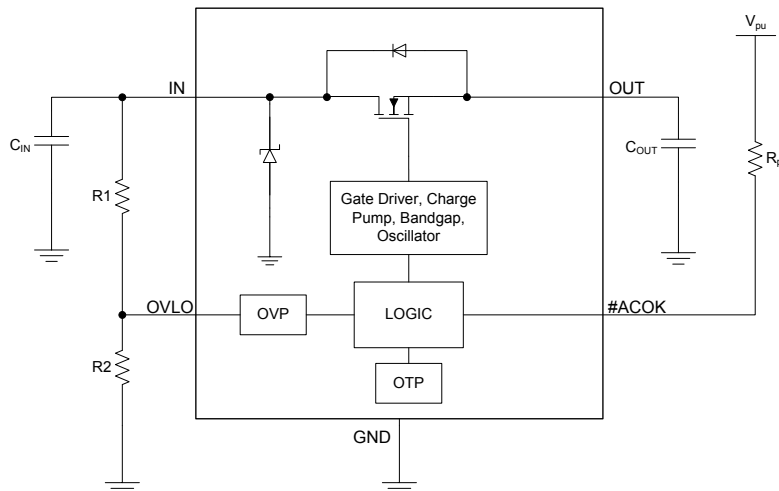

Figure 1. Functional Block Diagram

Pin Configuration

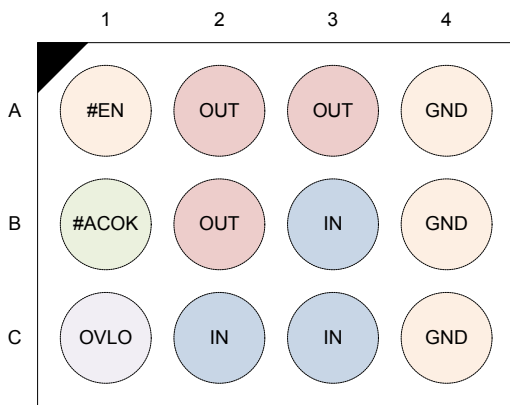
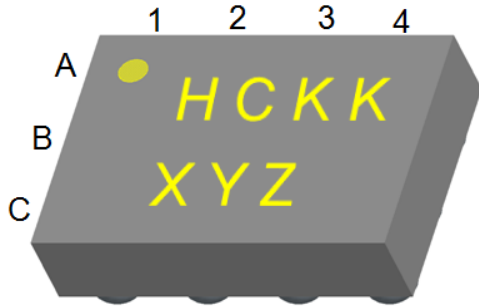

Figure 2. Pin Configuration (Top View)

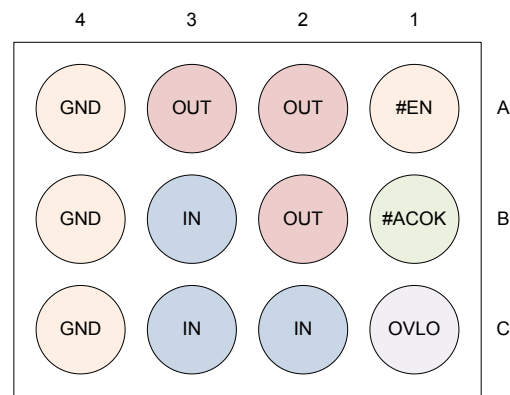
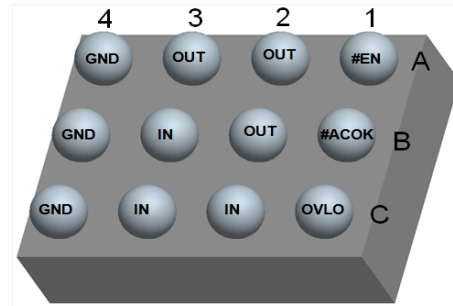

Figure 3. Pin Configuration (Bottom View)

Pin Definitions

Name	Bump	Type	Description	
IN	B3, C2, C3	Input/Supply	Switch Input and Device Supply	
OUT	A2, A3, B2	Output	Switch Output to Load	
#ACOK	B1	Output (Open Drain)	1	$V_{IN} < V_{IN_min}$ or $V_{IN} \geq V_{OVLO}$
			0	Voltage Stable
#EN	A1	Input	Device Enable (Active LOW)	
OVLO	C1	Input	Over-Voltage Lockout Adjustment Pin	
GND	A4, B4, C4	Supply	Device Ground	

Over-Voltage Lockout (OVLO) Calculation

OVLO can be set externally and override default OVP. By connecting an external resistor-driver to the OVLO pin. Equation (1) can produce the desired trip voltage and resistor values.

$$V_{IN_OLVO} = V_{OVLO_TH} \times [1 + R1/R2] \quad (1)$$

Recommended minimum R1 = 1 MΩ.

On-The-Go (OTG) Functionality

During OTG operation, the FPF2280 is initially disabled and the power FET's bulk diode is forward biased. The bulk diode represents ~0.7 V drop across the device, which remains until the V_{IN} voltage increases past 2.5 V, when the device is fully enabled. While the device is disabled and the body diode is forward biased, the max DC current through the diode is 1.8 A. This current is limited by the thermal performance of the device

($0.7 V \times 1.8 A = 1.36 W$). This current should be transient; the #EN pin must be pulled LOW to ensure the device fully enables. The transient should not exceed the RC time constant of the C_{IN} and C_{OUT} capacitors. At the system level, over-voltage and current protection should be provided outside the FPF2280.

Absolute Maximum Ratings

Stresses exceeding the absolute maximum ratings may damage the device. The device may not function or be operable above the recommended operating conditions and stressing the parts to these levels is not recommended. In addition, extended exposure to stresses above the recommended operating conditions may affect device reliability. The absolute maximum ratings are stress ratings only.

Symbol	Parameter	Min.	Max.	Unit
V_{IN}	V_{IN} to GND & V_{IN} to V_{OUT} = GND or Float	-0.3	29.0	V
V_{OUT}	V_{OUT} to GND	-0.3	$V_{IN} + 0.3$	V
V_{OVLO}	OVLO to GND	-0.3	24.0	V
$V_{\#EN_ACOK}$	Maximum DC Voltage Allowed on #EN or ACOK Pin		6	V
I_{IN}	Switch I/O Current (Continuous)		4.5	A
t_{PD}	Total Power Dissipation at $T_A = 25^\circ C$		1.48	W
T_{STG}	Storage Temperature Range	-65	+150	$^\circ C$
T_J	Maximum Junction Temperature		+150	$^\circ C$
T_L	Lead Temperature (Soldering, 10 Seconds)		+260	$^\circ C$
Θ_{JA}	Thermal Resistance, Junction-to-Ambient ⁽¹⁾ (1-in. ² Pad of 2-oz. Copper)		84.1	$^\circ C/W$
ESD	IEC 61000-4-2 System ESD	Air Gap	15.0	kV
		Contact	8.0	
	Human Body Model, ANSI/ESDA/JEDEC JS-001-2012	All Pins	3.5	
	Charged Device Model, JESD22-C101	All Pins	2.0	
Surge	IEC 61000-4-5, Surge Protection	V_{IN}	100	V

Note:

1. Measured using 2S2P JEDEC std. PCB.

Recommended Operating Conditions

The Recommended Operating Conditions table defines the conditions for actual device operation. Recommended operating conditions are specified to ensure optimal performance to the datasheet specifications. ON Semiconductor does not recommend exceeding them or designing to Absolute Maximum Ratings.

Symbol	Parameter	Min.	Max.	Unit
V_{IN}	Supply Voltage	2.5	20.0	V
T_A	Operating Temperature	-40	+105	$^\circ C$

Electrical Characteristics

$T_A = -40^{\circ}\text{C}$ to 105°C unless otherwise indicated. Typical values are $V_{IN} = 5.0\text{ V}$, $I_{IN} \leq 3\text{ A}$, $C_{IN} = 0.1\text{ }\mu\text{F}$ and $T_A = 25^{\circ}\text{C}$.

Symbol	Parameter	Conditions	Min.	Typ.	Max.	Unit
V_{IN_CLAMP}	Input Clamping Voltage	$I_{IN} = 10\text{ mA}$		35		V
I_Q	Input Quiescent Current	$V_{IN} = 5\text{ V}$, $\#EN = 0\text{ V}$		58	100	μA
I_{IN_Q}	OVLO Supply Current	$V_{OVLO} = 3\text{ V}$, $V_{IN} = 5\text{ V}$, $V_{OUT} = 0\text{ V}$		63	100	μA
V_{IN_OVLO}	Internal Over-Voltage Trip Level	V_{IN} Rising, $OVLO = \text{GND}$	6.6	6.8	7.0	V
		V_{IN} Falling	6.2			V
V_{OVLO_TH}	OVLO Set Threshold	$V_{IN} = 2.5\text{ V}$ to V_{OVLO}	1.12	1.20	1.24	V
V_{OVLO_RNG}	Adjustable OVLO Threshold Range	$V_{IN} = 2.5\text{ V}$ to V_{OVLO}	4		20	V
V_{OVLO_SELECT}	External OVLO Select Threshold			0.30	0.28	V
R_{ON}	Resistance from V_{IN} to V_{OUT}	$V_{IN} = 5\text{ V}$, $I_{OUT} = 1\text{ A}$, $T_A = 25^{\circ}\text{C}$		30	39	$\text{m}\Omega$
C_{OUT}	OUT Load Capacitance ⁽²⁾	$V_{IN} = 5\text{ V}$			1000	μF
I_{OLVO}	OVLO Input Leakage Current	$V_{OVLO} = V_{OVLO_TH}$	-100		100	nA
T_{SDN}	Thermal Shutdown ⁽²⁾			130		$^{\circ}\text{C}$
T_{SDN_HYS}	Thermal Shutdown Hysteresis ⁽²⁾			20		$^{\circ}\text{C}$
Digital Signals						
V_{OL}	#ACOK Output Low Voltage	$V_{IO} = 3.3\text{ V}$, $I_{SINK} = 1\text{ mA}$			0.4	V
$V_{IH_}\#EN$	Enable HIGH Voltage	$V_{IN} = 2.5\text{ V}$ to V_{OVLO}	1.2			V
$V_{IL_}\#EN$	Enable LOW Voltage	$V_{IN} = 2.5\text{ V}$ to V_{OVLO}			0.5	V
I_{ACOK_LEAK}	#ACOK Leakage Current	$V_{IO} = 3.3\text{ V}$, #ACOK Deasserted, #EN = 0 V	-0.5		0.5	μA
#EN_Leak	#EN Leakage Current	$V_{IN} = 5.0\text{ V}$, $V_{OUT} = \text{Float}$	-1.0		1.0	μA
Timing Characteristics						
t_{DEB}	Debounce Time	Time from $2.5\text{ V} < V_{IN} < V_{IN_OVLO}$ to $V_{OUT} = 0.1 \times V_{IN}$		15		ms
t_{START}	Soft-Start Time	Time from $V_{IN} = V_{IN_min}$ to $0.2 \times \#ACOK$, $V_{IO} = 1.8\text{ V}$ with $10\text{ k}\Omega$ Pull-up Resistor		30		ms
t_{ON}	Switch Turn-On Time	$V_{IN} = 5\text{ V}$, $R_L = 100\text{ }\Omega$, V_{OUT} from $0.1 \times V_{IN}$ to $0.9 \times V_{IN}$, $C_{LOAD} = 100\text{ }\mu\text{F}$		2		ms
t_{OFF}	Switch Turn-Off Time ⁽²⁾	$R_L = 100\text{ }\Omega$, $C_L = 0\text{ }\mu\text{F}$, $V_{IN} > V_{OVLO}$ to $V_{OUT} = 0.8 \times V_{IN}$		125		ns

Note:

- Guaranteed by characterization and design.

Timing Diagrams

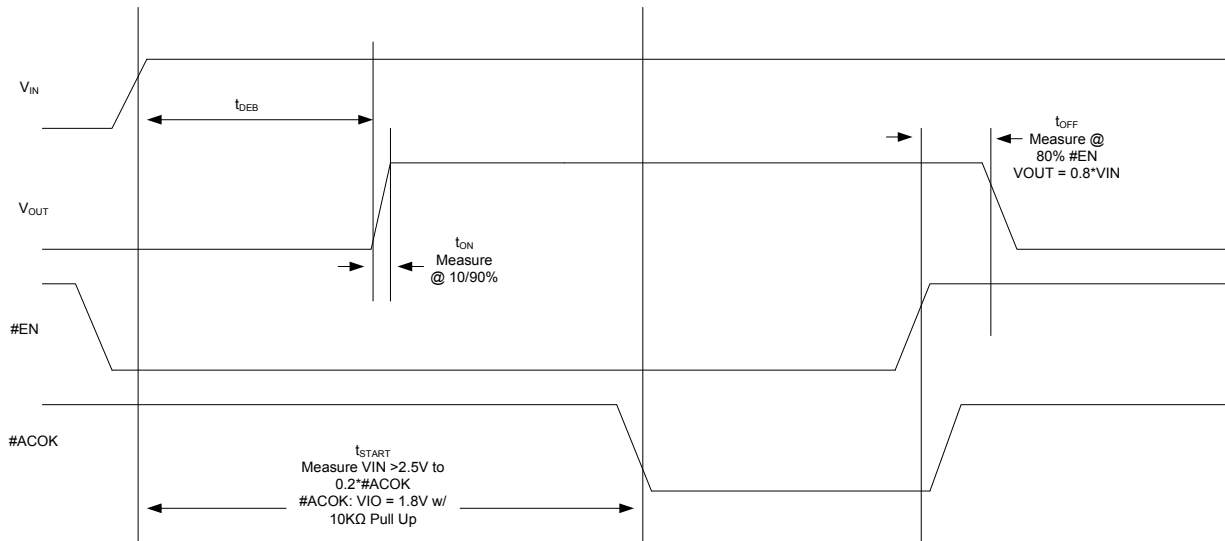

Figure 4. Timing for Power Up and Normal Operation

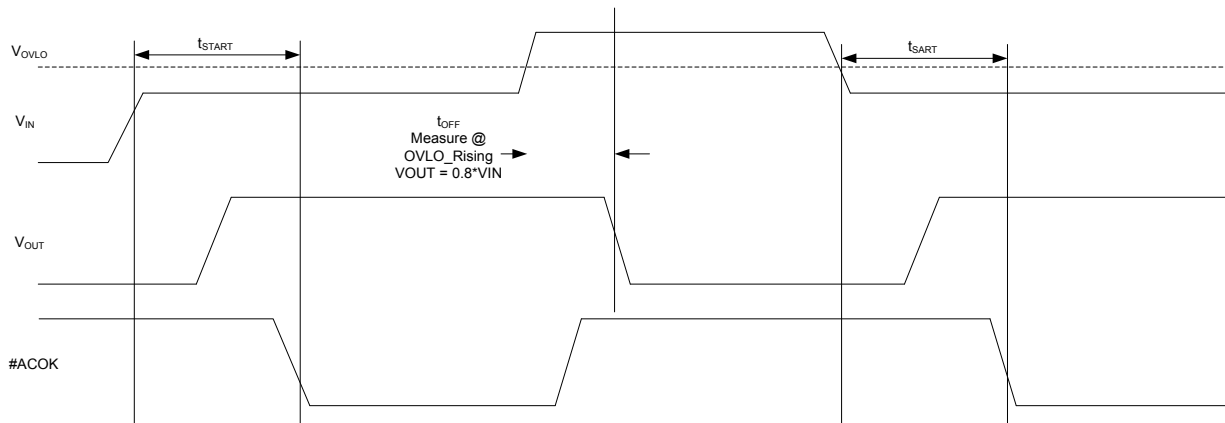
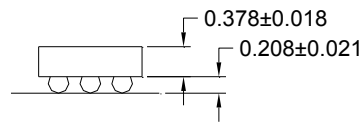
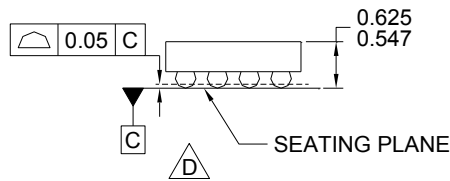
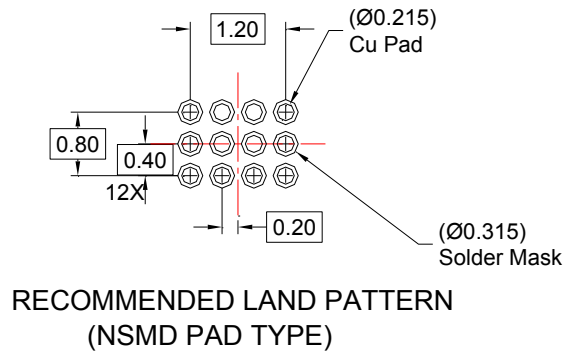
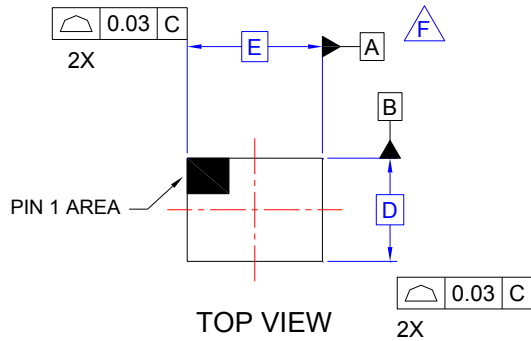

Figure 5. Timing for OVLO Trip

Product-Specific Package Dimensions

D	E	X	Y
1288 $\mu\text{m} \pm 30 \mu\text{m}$	1828 $\mu\text{m} \pm 30 \mu\text{m}$	314 $\mu\text{m} \pm 18 \mu\text{m}$	244 $\mu\text{m} \pm 18 \mu\text{m}$

Physical Dimensions



SIDE VIEWS

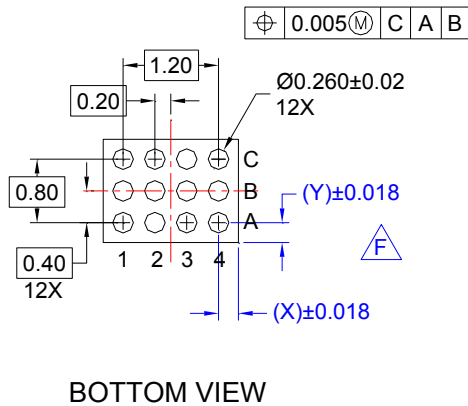

NOTES:

- A. NO JEDEC REGISTRATION APPLIES.
- B. DIMENSIONS ARE IN MILLIMETERS.
- C. DIMENSIONS AND TOLERANCES PER ASME Y14.5M, 2009.
- D. DATUM C IS DEFINED BY THE SPHERICAL CROWNS OF THE BALLS.
- E. PACKAGE NOMINAL HEIGHT IS 586 MICRONS ±39 MICRONS (547-625 MICRONS).
- F. FOR DIMENSIONS D, E, X, AND Y SEE PRODUCT DATASHEET.
- G. DRAWING FILENAME: MKT-UC012ZCrev2..
- H. ON SEMICONDUCTOR RECOMMENDS THAT LANDS IN THE LANDPATTERN ARE AT LEAST .215MM DIAMETER AS MEASURED AT THE BOTTOM OF THE LAND, NOT THE TOP EDGE

Figure 6. 12-Ball, 3×4 Array, 0.4 mm Pitch, Wafer-Level Chip-Scale Package (WLCSP)

ON Semiconductor and the ON Semiconductor logo are trademarks of Semiconductor Components Industries, LLC dba ON Semiconductor or its subsidiaries in the United States and/or other countries. ON Semiconductor owns the rights to a number of patents, trademarks, copyrights, trade secrets, and other intellectual property. A listing of ON Semiconductor's product/patent coverage may be accessed at www.onsemi.com/site/pdf/Patent-Marking.pdf. ON Semiconductor reserves the right to make changes without further notice to any products herein. ON Semiconductor makes no warranty, representation or guarantee regarding the suitability of its products for any particular purpose, nor does ON Semiconductor assume any liability arising out of the application or use of any product or circuit, and specifically disclaims any and all liability, including without limitation special, consequential or incidental damages. Buyer is responsible for its products and applications using ON Semiconductor products, including compliance with all laws, regulations and safety requirements or standards, regardless of any support or applications information provided by ON Semiconductor. "Typical" parameters which may be provided in ON Semiconductor data sheets and/or specifications can and do vary in different applications and actual performance may vary over time. All operating parameters, including "Typicals" must be validated for each customer application by customer's technical experts. ON Semiconductor does not convey any license under its patent rights nor the rights of others. ON Semiconductor products are not designed, intended, or authorized for use as a critical component in life support systems or any FDA Class 3 medical devices or medical devices with a same or similar classification in a foreign jurisdiction or any devices intended for implantation in the human body. Should Buyer purchase or use ON Semiconductor products for any such unintended or unauthorized application, Buyer shall indemnify and hold ON Semiconductor and its officers, employees, subsidiaries, affiliates, and distributors harmless against all claims, costs, damages, and expenses, and reasonable attorney fees arising out of, directly or indirectly, any claim of personal injury or death associated with such unintended or unauthorized use, even if such claim alleges that ON Semiconductor was negligent regarding the design or manufacture of the part. ON Semiconductor is an Equal Opportunity/Affirmative Action Employer. This literature is subject to all applicable copyright laws and is not for resale in any manner.

PUBLICATION ORDERING INFORMATION

LITERATURE FULFILLMENT:

Literature Distribution Center for ON Semiconductor
19521 E. 32nd Pkwy, Aurora, Colorado 80011 USA
Phone: 303-675-2175 or 800-344-3860 Toll Free USA/Canada
Fax: 303-675-2176 or 800-344-3867 Toll Free USA/Canada
Email: orderlit@onsemi.com

N. American Technical Support: 800-282-9855 Toll Free
USA/Canada.

Europe, Middle East and Africa Technical Support:
Phone: 421 33 790 2910

Japan Customer Focus Center
Phone: 81-3-5817-1050

ON Semiconductor Website: www.onsemi.com

Order Literature: <http://www.onsemi.com/orderlit>

For additional information, please contact your local
Sales Representative