

L-GAGE™ Q50 Series with Complementary Discrete Outputs

LED-Based Linear Displacement Sensor with Complementary Discrete Outputs and TEACH-Mode Programming



L-GAGE Q50 Complementary Discrete Output Sensor Features

- Cost-effective LED-based complementary-discrete sensor
- Fast, easy-to-use TEACH-Mode programming; no potentiometer adjustments
- Models available with either 4 or 48 millisecond response speed
- Models available with either visible red or infrared beam
- Teach a sensing window (2 switch points) or teach single switch point (adjustable field mode)
- Two sensing ranges, depending on model: 100 to 300 mm (visible red beam models), and 100 to 400 mm (infrared beam models)
- Good color sensitivity
- Remote TEACH input for security and convenience
- Two bicolor Status LEDs
- Choose 2 meter or 9 meter unterminated cable, or swivel 5-pin Euro-style QD connector
- Rugged construction withstands demanding sensing environments; rated IEC IP67, NEMA 6

L-GAGE Q50 Complementary Discrete Output Sensor Models

Model Number	Sensing Range	Cable*	Supply Voltage	Beam	Output	Response Time	
Q50BVN	100 to 300 mm (3.9" to 11.8")	5-wire, 2 m (6.5') cable	12 to 30V dc	Visible Red LED	Complementary NPN	48 ms	
Q50BVNQ		5-pin Euro-style QD				4 ms	
Q50BVNY		5-wire, 2 m (6.5') cable				Complementary PNP	48 ms
Q50BVNYQ		5-pin Euro-style QD					4 ms
Q50BVP		5-wire, 2 m (6.5') cable			Complementary NPN		48 ms
Q50BVPQ		5-pin Euro-style QD					4 ms
Q50BVPY		5-wire, 2 m (6.5') cable				Complementary PNP	48 ms
Q50BVPYQ		5-pin Euro-style QD					4 ms
Q50BN	100 to 400 mm (3.9" to 15.7")	5-wire, 2 m (6.5') cable		Infrared LED	Complementary NPN		48 ms
Q50BNQ		5-pin Euro-style QD					4 ms
Q50BNY		5-wire, 2 m (6.5') cable				Complementary PNP	48 ms
Q50BNYQ		5-pin Euro-style QD					4 ms
Q50BP		5-wire, 2 m (6.5') cable			Complementary PNP		48 ms
Q50BPQ		5-pin Euro-style QD					4 ms
Q50BPY		5-wire, 2 m (6.5') cable				Complementary PNP	48 ms
Q50BPYQ		5-pin Euro-style QD					4 ms

* 9 meter cables are available by adding suffix "W/30" to the model number of any cabled sensor (e.g., **Q50BVN W/30**). A model with a QD connector requires a mating cable; see page 8.

L-GAGE Q50 – Complementary Discrete Output Sensor

Sensor Overview

The Q50 Complementary Discrete is an easy-to-use triangulation sensor which provides a sophisticated, yet cost-effective solution for demanding applications. Q50 Series sensors feature compact, all-in-one design and require no separate controller.

Each sensor has two discrete outputs (both NPN or both PNP). The complementary output can be configured for one of two conditions:

- A sensing window consisting of two switch points
- A single switch point, as with an adjustable-field sensor

Optical Triangulation

The function of the Q50 Sensor is based on optical triangulation (see Figure 1). The emitter circuitry and optics create a light source which is directed toward a target. The light source bounces off the target, scattering some of its light through the sensor's receiver lens to its position-sensitive-device (PSD) receiver element. The target's distance from the receiver determines the light's angle to the receiver element; this angle determines where the returned light will touch the PSD receiver element.

The position of the light on the PSD receiver element is processed through digital electronics and analyzed by the microprocessor. The microprocessor will compare the target position to the taught window limits and then change the discrete outputs as required.

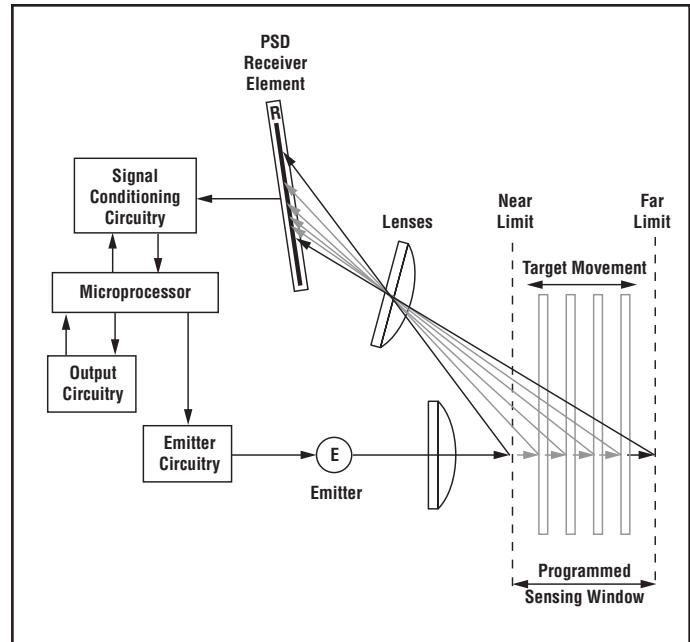

Figure 1. Using optical triangulation to determine sensing distance

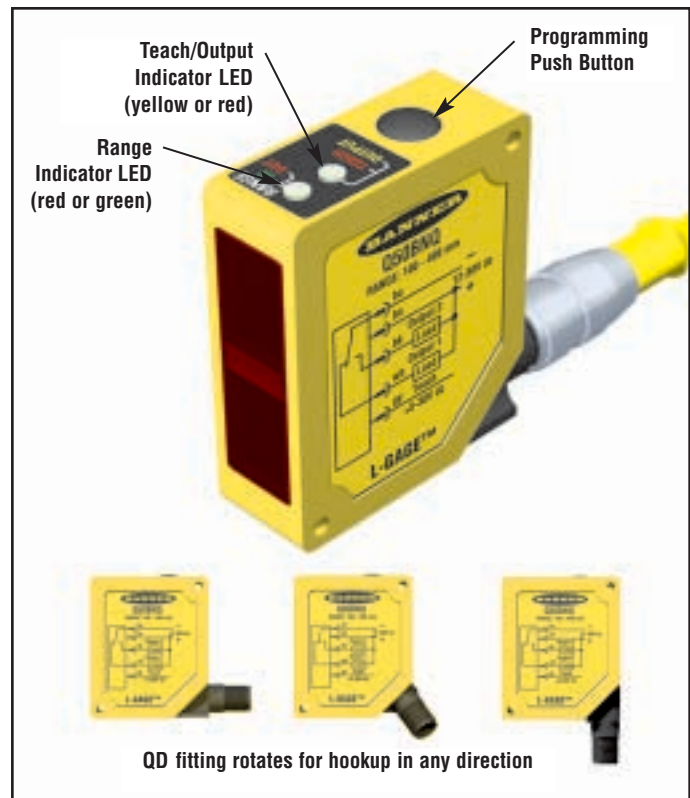

Figure 2. L-GAGE Q50 sensor features

L-GAGE Q50 – Complementary Discrete Output Sensor

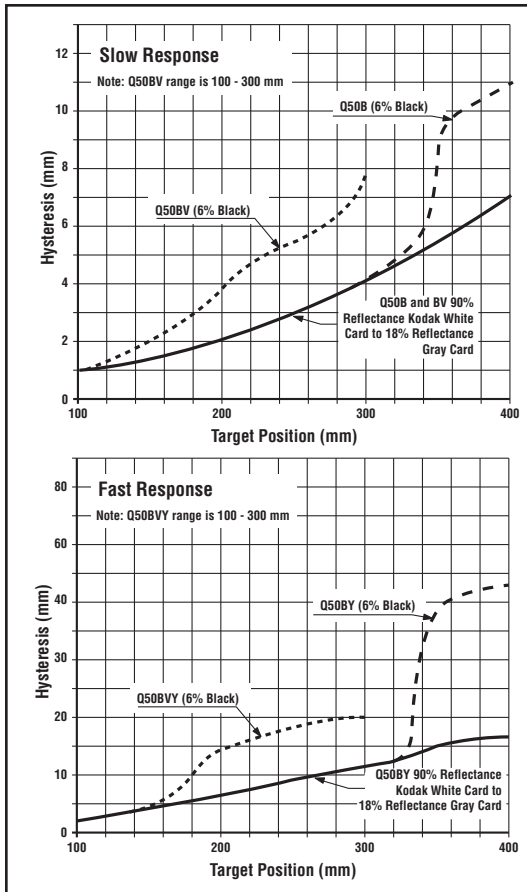
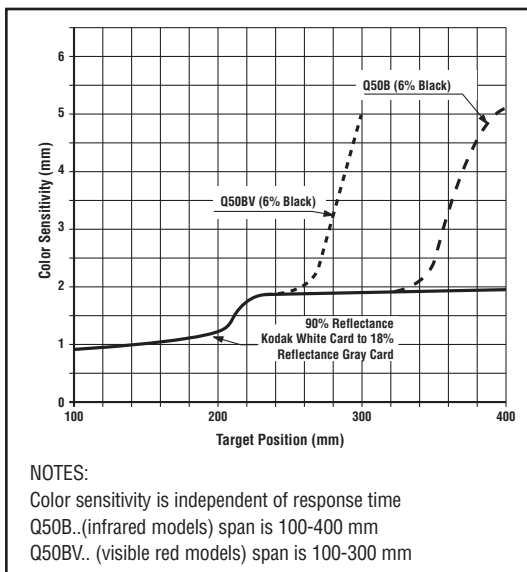

Figure 3. L-GAGE Q50B (Complementary Discrete) Hysteresis vs. Position



NOTES:
 Color sensitivity is independent of response time
 Q50B..(infrared models) span is 100-400 mm
 Q50BV.. (visible red models) span is 100-300 mm

Figure 4. L-GAGE Q50B Complementary Discrete Color Sensitivity vs. Position (This represents the expected change in output when the target color is changed from a 90% reflectance Kodak White Card to a 6% and 18% reflectance surface.)

Using the L-GAGE Q50 Complementary Discrete Output Sensor

Response Speed

Response speed is either Fast (4 ms) or Slow (48 ms), depending on model.

Window Limits

Window limits may be taught to the sensor either remotely (using the gray wire) or by using the sensor's Teach push button.

The Q50 sensor operates in two modes: TEACH (or programming) mode and RUN mode.

NOTE: All LED indicators momentarily go OFF when the sensor changes state between RUN and TEACH modes.

Indicator Status Conditions

Indicator	Status
Range LED (green/red)	Green — Target is within sensing range Red — Target is outside sensing range Flashing Green — Discrete output overloaded OFF — Sensor Power OFF

Teach/Output LED (yellow/red)	Yellow (window limits) — Target is within taught limits Yellow (fixed field) — Target is closer than cutoff limit OFF — Target is outside taught window limits Red — Sensor is in TEACH mode
-------------------------------	---

TEACH-Mode Programming

Push-Button Procedure for Teaching Window Limits (Complementary Outputs)

1. Press and hold the Teach push button until the Teach LED turns red (depress button for about 2 seconds). This indicates the sensor is waiting for the first window limit.
2. Position the target for the first limit. The Range LED should be green, indicating a valid target. Briefly "click" the Teach push button. This will teach the sensor the first limit. The Teach LED will flash red at 2 Hz to acknowledge receiving the first window limit; it is now waiting for the second limit.
3. Position the target for the second limit and "click" the Teach push button again to teach the sensor the second limit. The Teach LED will return to either yellow or OFF as the sensor returns to RUN mode.

NOTE: The yellow LED follows the black wire output.

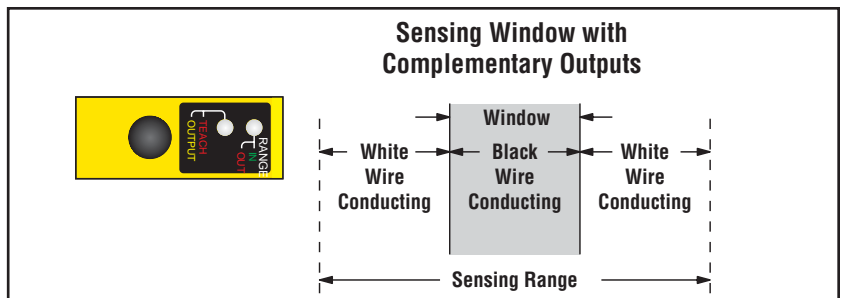

Figure 5. Programming a single pair of sensing window limits, complementary outputs

L-GAGE Q50 – Complementary Discrete Output Sensor

Push-Button Procedure for Teaching a Single Sensing Set Point (Complementary Outputs – Adjustable-Field Style)

The black wire conducts when the target is inside the programmed set point. The white wire conducts when the target is outside (away from) the set point (see Figure 7).

1. Press and hold the Teach push button until the Teach LED turns Red (depress button for approximately 2 seconds).
2. Position the target at the sensing set point. The Range LED should be green, indicating a valid target. Briefly “click” the Teach push button. This will teach the sensor the first limit. The Teach LED will flash red at 2 Hz to acknowledge receiving the first window limit; it is now waiting for a second limit.
3. Maintain the same target position and “click” the Teach push button again to teach the same window position. The Teach LED will return to either yellow or OFF as the sensor returns to RUN mode.

Note: The yellow LED will follow the black wire output.

Remote Programming

A function is provided to program the sensor remotely or to disable/enable the push button; this is accomplished via the gray wire. Disabling the push button prevents anyone on the production floor from adjusting any of the programming settings. Connect the gray wire of the Q50 Sensor to +5 to 30V dc, with a remote programming switch connected between them. NOTE: The impedance of the remote teach input is 15 kΩ.

To program, pulse the wire as illustrated in Figure 6. NOTE: The duration of each pulse (corresponding to a push button “click”) is 0.04 to 0.8 seconds.

Run Mode

NOTE: All LED indicators momentarily go OFF when the sensor changes state between RUN and TEACH modes.

Range LED

When the sensor detects a target within its sensing range (either 100 to 300 mm for visible-beam models, or 100 to 400 mm for infrared beam models) the LED will be solid green. In the absence of a target, the Range LED is solid red. Refer to the Indicator Status table on page 3.

Teach/Output LED

In RUN mode, the Output LED is yellow when a target is sensed within the programmed window limits; otherwise the Output LED is red. Refer to the Indicator Status table on page 3.

Complementary Discrete Outputs

The complementary discrete outputs are either both NPN or both PNP. The outputs are configured via the Teach procedure to either a single window or a fixed-field (single set point) application. The outputs are short circuit-protected and can switch up to 150 mA (resistive load).

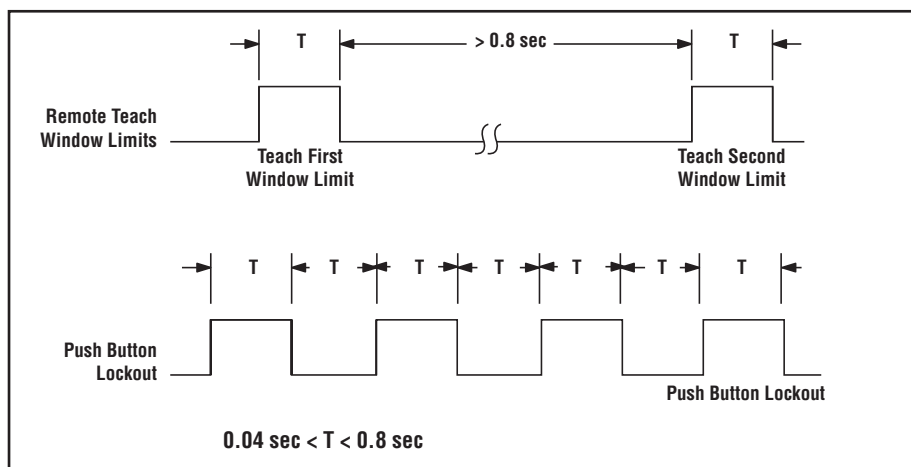

Figure 6. Timing for remote TEACH programming

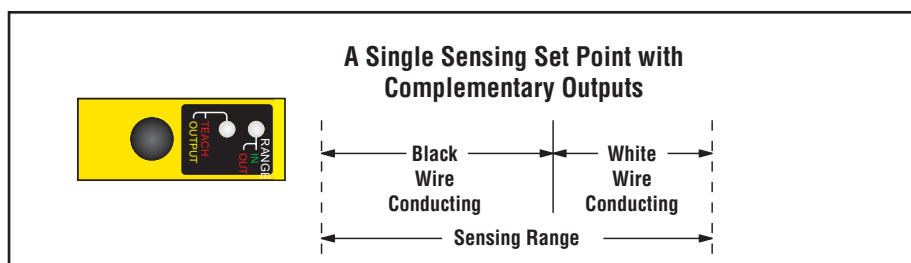

Figure 7. Programming separate sensing set point limits, complementary outputs

L-GAGE Q50 – Complementary Discrete Output Sensor

Installation Notes

Some targets (those with a stepped plane facing the sensor, a boundary line, or rounded targets) pose specific problems for sensing distances. For such applications, see Figure 8 for suggested mounting orientations.

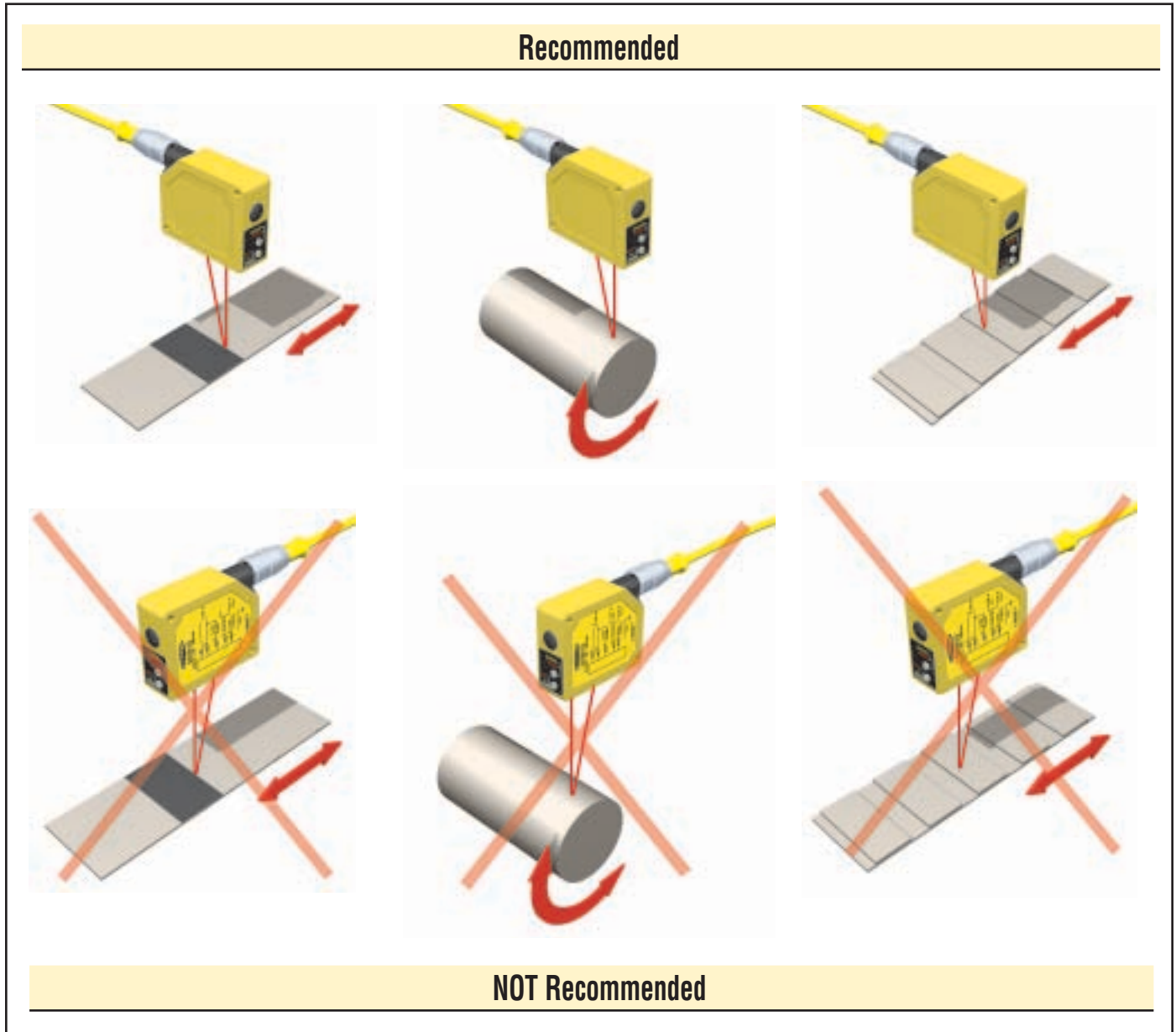

Figure 8. Sensor orientations for typical targets

L-GAGE Q50 – Complementary Discrete Output Sensor

L-GAGE Q50 Complementary Discrete Output Sensor Specifications

Sensing Range	Q50BV: 100 to 300 mm (3.9" to 11.8")	Q50B: 100 to 400 mm (3.9" to 15.7")						
Supply Voltage	12 to 30V dc (10% maximum ripple); 70 mA max. (exclusive of load)							
Supply Protection Circuitry	Protected against reverse polarity and transient overvoltages							
Delay at Power-up	2 seconds							
Sensing Beam	Wave length Q50BV: 685 nm (typical) Q50B: 880 nm (typical) Beam Size Q50BV: 20 mm dia. (max.) Q50B: 20 mm dia. (max.)							
Output Rating	Complementary Discrete Output 150 mA maximum, per output OFF-state leakage current: Less than 10 micro-amps ON-state saturation voltage: Less than 1V @ 10 mA and less than 1.5V @ 100 mA							
Output Configuration	SPDT (complementary) solid-state dc switch. Choose NPN (current sinking) or PNP (current sourcing) outputs.							
Output Protection	Protected against false pulse on power-up and continuous overload or short circuit of outputs							
Output Response Time	2-second delay on power-up Fast: 4 ms ON, 4 ms OFF Slow: 48 ms ON, 48 ms OFF							
Output Hysteresis	See Figure 3							
Sensing Repeatability	Slow Response (Q50B): 0.5% of sensing distance Fast Response (Q50B...Y): 1.0% of sensing distance							
Color Sensitivity (typical)	See Figure 4							
Remote Teach Input Impedance	15 kΩ							
Remote Teach Input	To Teach: Connect gray wire to +5 to 30V dc To Disable: Connect gray wire to 0 to +2V dc (or open connection)							
Adjustments	Sensing Window Limits: TEACH-mode programming of near and far window limits may be set using the Teach push button or remotely via the gray Teach wire.							
Indicators	<p>Range LED Indicator (green/red)</p> <p>Green — Target is within sensing range Red — Target is outside sensing range Flashing Green — Outputs are overloaded OFF — Sensor Power OFF</p> <p>Teach/Output LED Indicator (yellow/red)</p> <p>Yellow (window limits) — Target is within taught limits Yellow (fixed field) — Target is closer than cutoff limit OFF — Target is outside taught window limits Red — Sensor is in TEACH mode</p>							
Minimum Taught Window (millimeters)	Model Number	Distance						
		100 mm	150 mm	200 mm	250 mm	300 mm	350 mm	400 mm
	Q50BV..	1	2.0	3.5	5.0	7	–	–
	Q50BV..Y	2	4	7	10	14	–	–
	Q50B..	1	2.0	3.5	5.0	7	10	15
	Q50B..Y	2	4	7	10	14	20	30
Ambient Light Immunity	<10,000 Lux							

L-GAGE Q50 – Complementary Discrete Output Sensor

L-GAGE Q50 Complementary Discrete Output Sensor Specifications (continued)

Construction	Housing: Molded ABS/Polycarbonate Window Lens: Acrylic
Environmental Rating	IEC IP67, NEMA 6
Connections	2 m or 9 m 5-conductor PVC-covered attached cable or 5-pin Euro-style quick disconnect
Operating Conditions	Temperature: -10° to +55°C (+14° to +131°F) Max. Rel. Humidity: 90% at +50°C (non-condensing)
Vibration and Mechanical Shock	All models meet Mil. Std. 202F requirements. Method 201A (Vibration: 10 to 60Hz max. double amplitude 0.06", maximum acceleration 10G). Also meets IEC 947-5-2 requirements: 30G, 11 ms duration, half sine wave.
Application Notes	Allow 15-minute warm-up for maximum performance.
Hardware	M3 hardware is included.

L-GAGE Q50 Dimensions

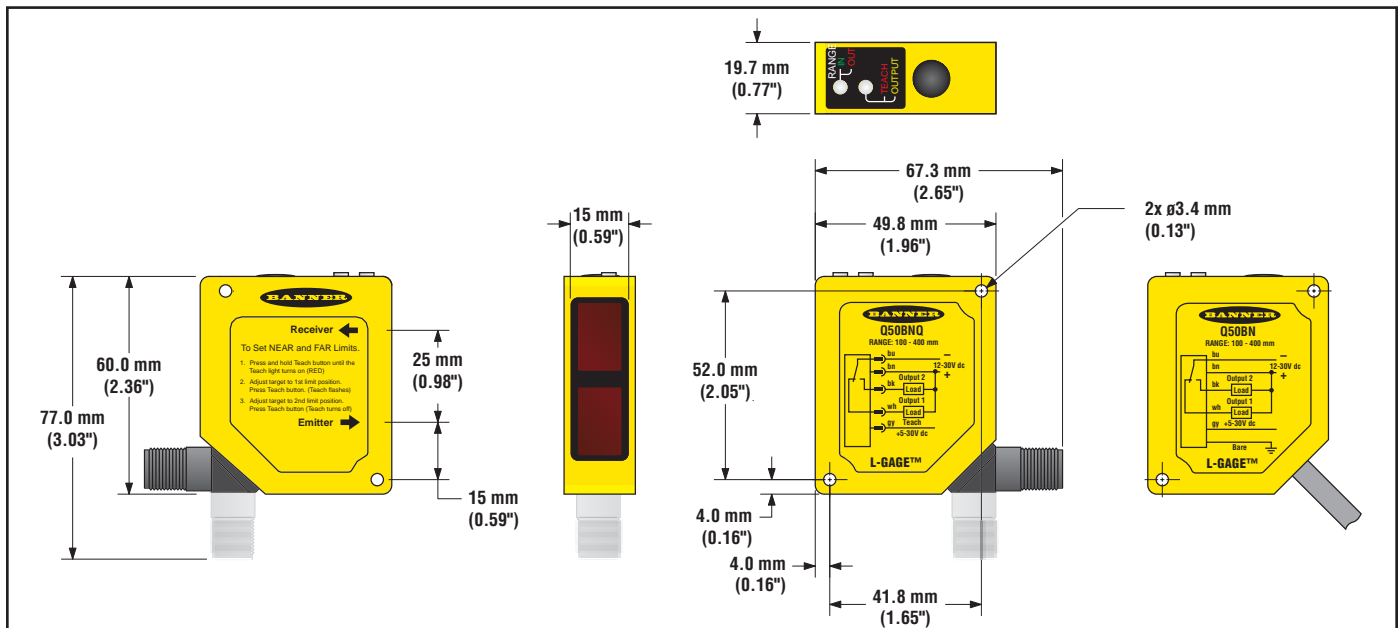

L-GAGE Q50 Hookups

NPN Hookups

Cabled Models Quick-Disconnect Models

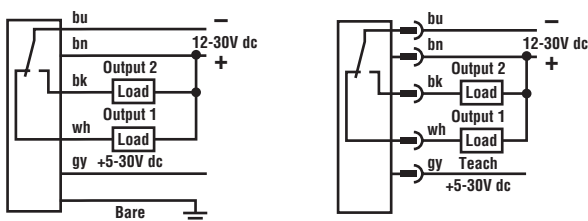

PNP Hookups

Cabled Models Quick-Disconnect Models

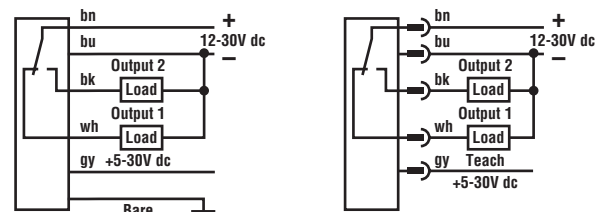

L-GAGE Q50 – Complementary Discrete Output Sensor

Accessories

Euro-Style Quick-Disconnect Cables

Style	Model	Length	Connector	Pin-out
5-Pin Euro Straight	MQDEC2-506 MQDEC2-515 MQDEC2-530	2 m (6.5') 5 m (15') 9 m (30')		
5-Pin Euro Right-angle	MQDEC2-506RA MQDEC2-515RA MQDEC2-530RA	2 m (6.5') 5 m (15') 9 m (30')		

Mounting Brackets

SMBQ50	<ul style="list-style-type: none"> • Right-angle bracket • 14-ga., 304 Stainless Steel



more sensors, more solutions



WARNING . . .

Not To Be Used for Personnel Protection

Never use these products as sensing devices for personnel protection. Doing so could lead to serious injury or death.

These sensors do NOT include the self-checking redundant circuitry necessary to allow their use in personnel safety applications. A sensor failure or malfunction can cause either an energized or de-energized sensor output condition. Consult your current Banner Safety Products catalog for safety products which meet OSHA, ANSI and IEC standards for personnel protection.

WARRANTY: Banner Engineering Corp. warrants its products to be free from defects for one year. Banner Engineering Corp. will repair or replace, free of charge, any product of its manufacture found to be defective at the time it is returned to the factory during the warranty period. This warranty does not cover damage or liability for the improper application of Banner products. This warranty is in lieu of any other warranty either expressed or implied.