

Part No.

AL-33-01UY5C

Diff No.

3 mm

High Power

Type : LED Lamps

■ Package Dimension:

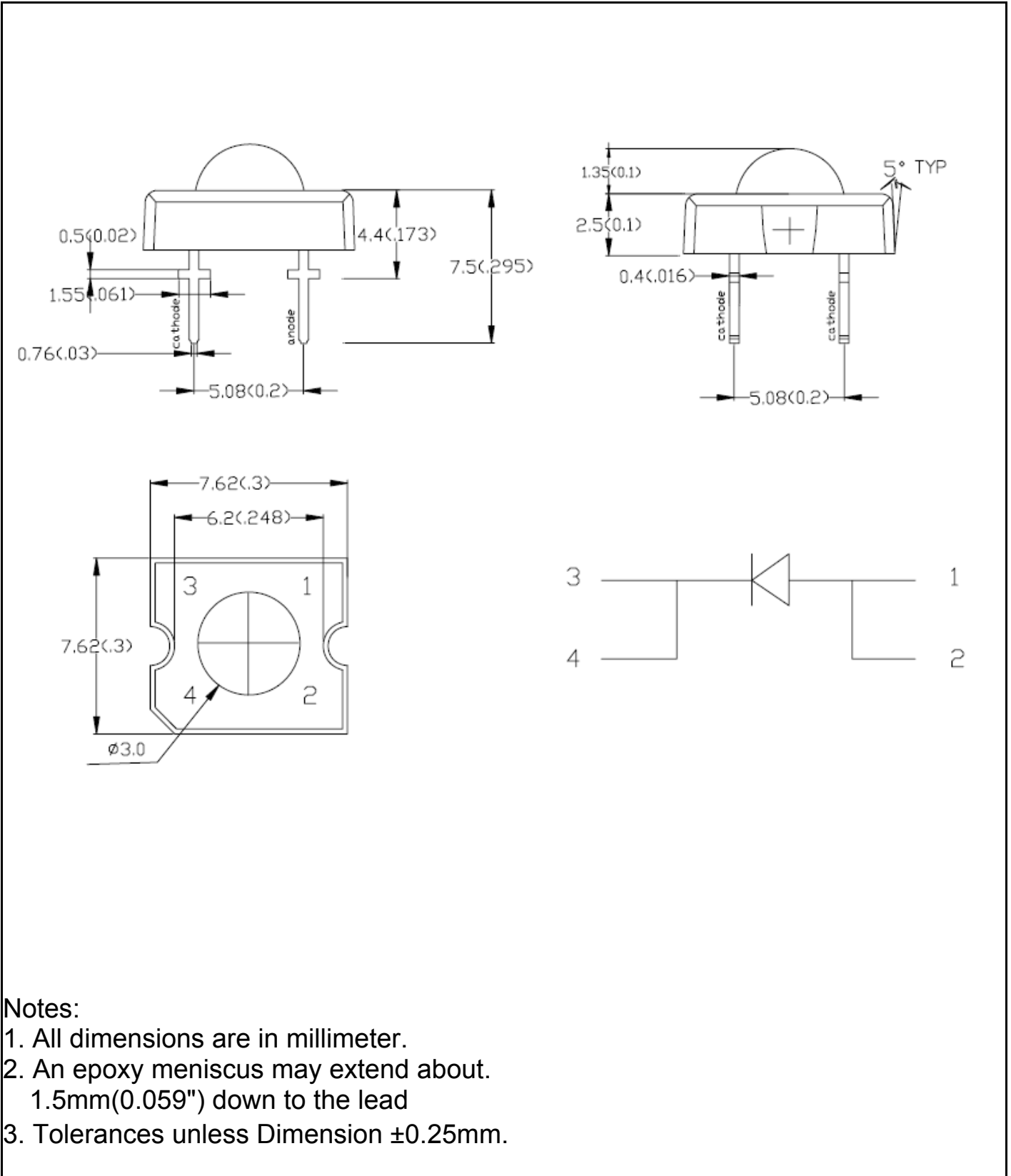

Notes:

1. All dimensions are in millimeter.
2. An epoxy meniscus may extend about 1.5mm(0.059") down to the lead
3. Tolerances unless Dimension ± 0.25 mm.

Part No. **AL-33-01UY5C**

Diff No.

3 mm

High Power

Type : LED Lamps

LED Parts P/N.	Chip		Lens Color
	Material	Emitted Color	
AL-33-01UY5C	AlGaInP	Super Yellow	Water Clear

■ Absolute Maximum Ratings at Ta=25°C

Parameter	Symbol	Rating	Unit
Continuous Forward Current	I_F	20	mA
Operating Temperature	T_{opr}	-30 to +80	°C
Storage Temperature	T_{stg}	-40 to +100	°C
Soldering Temperature	T_{sol}	260 ± 5	°C
Electrostatic Discharge	ESD	1000	V
Power Dissipation	P_D	120	mW
Peak Forward Current (Duty 1/10@1KHz)	I_F (Peak)	100	mA
Reverse Voltage	V_R	5	V

■ Electronic Optical Characteristics :

Parameter	Symbol	Min.	Typ.	Max.	Unit	Condition
Luminous Intensity	I_v	/	2000	/	mcd	$I_F=20mA$
Viewing Angle	$2\theta 1/2$	/	50	/	deg	---
Peak Wavelength	λ_p	/	595	/	nm	$I_F=20mA$
Dominant Wavelength	λ_d	/	590	/	nm	$I_F=20mA$
Spectrum Radiation Bandwidth	$\Delta\lambda$	/	30	/	nm	$I_F=20mA$
Forward Voltage	V_F	/	2.0	2.6	V	$I_F=20mA$
Reverse Current	I_R	/	/	50	μA	$V_R=5V$

Part No.

AL-33-01UY5C

Diff No.

3 mm

High Power

Type : LED Lamps

■ Reliability test items and conditions :

The reliability of products shall be satisfied with items listed below.

Confidence level: 90%

LTPD: 10%

NO	ITEM	Test Conditions	Test hours/cycle	Sample Q'ty	Ac/Re
1	Solder Heat	Temp : 260°C±5°C	5 sec	80 pcs	0/1
2	Temperature Cycle	H : +85°C 30min ∟ 5min L : -40°C 30min	100 cycles	80 pcs	0/1
3	Thermal Shock	H : +100°C 5min ∟ 10sec L : -10°C 5min	100 cycles	80 pcs	0/1
4	High Temperature Storage	Ta=100°C	1000 hrs	80 pcs	0/1
5	Low Temperature Storage	Ta=-40°C	1000 hrs	80 pcs	0/1
6	DC Operating Life	Temp : 25°C I _F =20mA	1000 hrs	80 pcs	0/1
7	High Temperature / High Humidity	85°C / 85%RH	1000 hrs	80 pcs	0/1

Part No.

AL-33-01UY5C

Diff No.

3 mm

High Power

Type : LED Lamps

◆ TYPICAL ELECTRICAL-OPTICAL CHARACTERISTICS CURVES

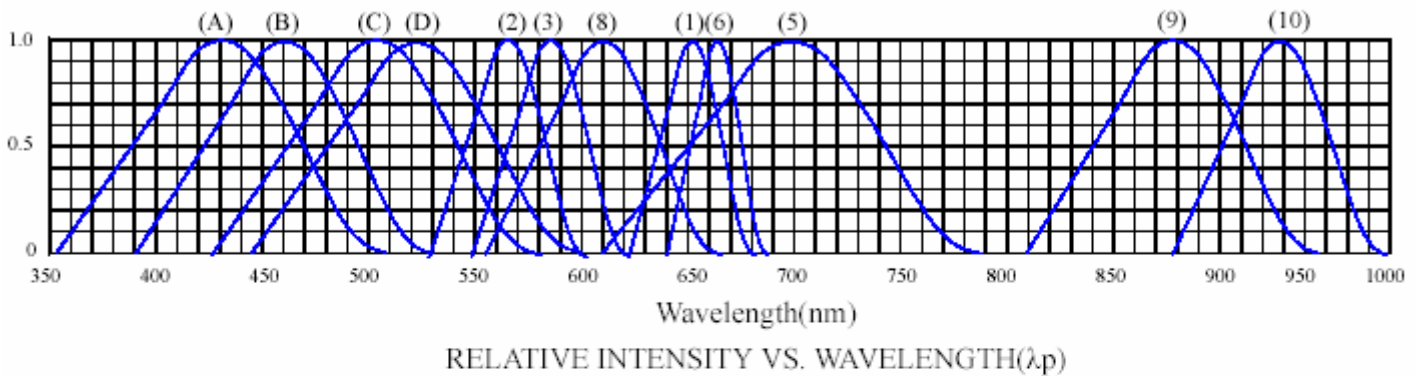
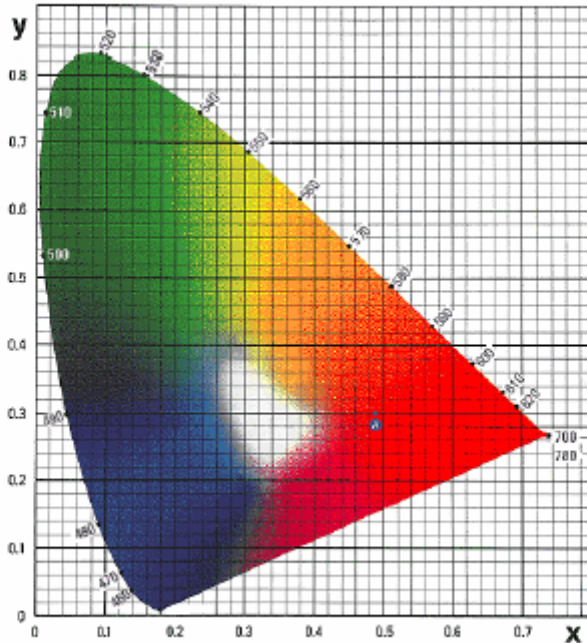

- (1) GaAsP/GaAs 655nm/Red
- (2) GaP 568nm/ Yellow Green
- (3) GaAsP/GaP 585nm/Yellow
- (4) GaAsP/GaP 635nm/Orange & Hi-Eff Red
- (5) GaP 700nm/Bright Red
- (6) GaAlAs/GaAs 660nm/Super Red
- (8) GaAsP/GaP 610nm/Super Red

- (9)- GaAlAs 880nm
- (10)-GaAs/GaAs&GaAlAs/GaAs 940nm
- (A)- GaN 430nm/Blue
- (B)- InGaN 470nm/Blue
- (C)- InGaN 502nm/Ultra Green
- (D)- InGaN 523nm/Ultra Green

Part No.

AL-33-01UY5C

Diff No.

3 mm

High Power

Type : LED Lamps

◆ CHARACTERISTICS DIAGRAMS

FORWARD CURRENT VS. FORWARD VOLTAGE

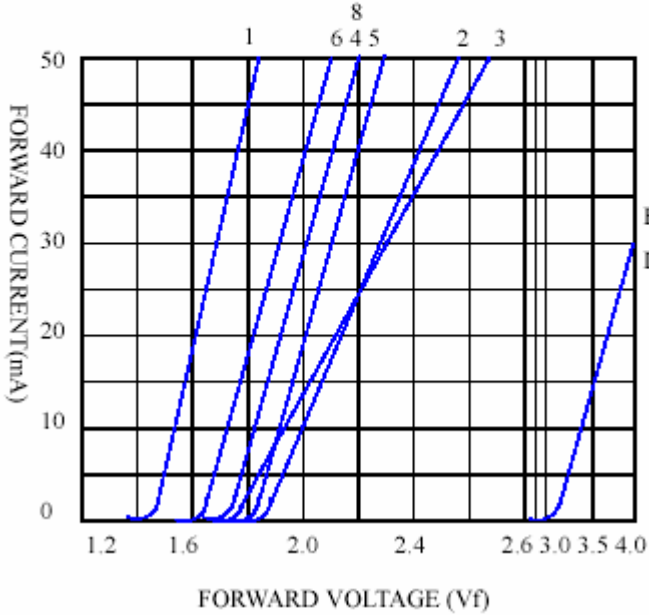

RELATIVE LUMINOUS INTENSITY VS. FORWARD CURRENT

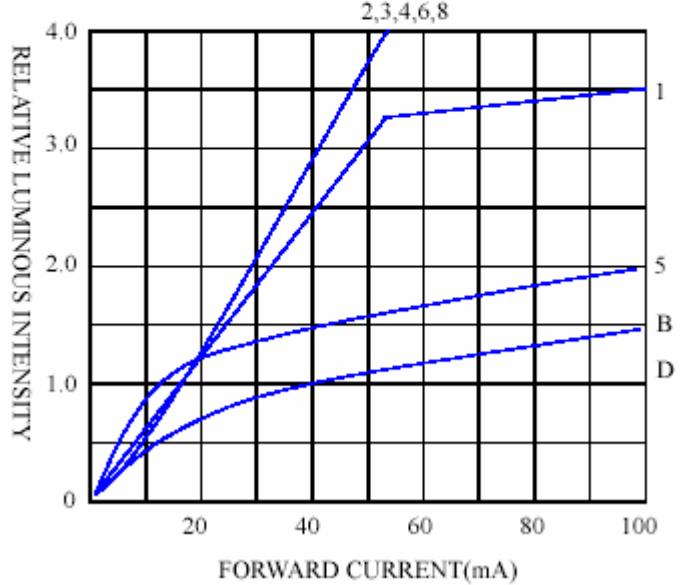

FORWARD CURRENT VS. AMBIENT TEMPERATURE

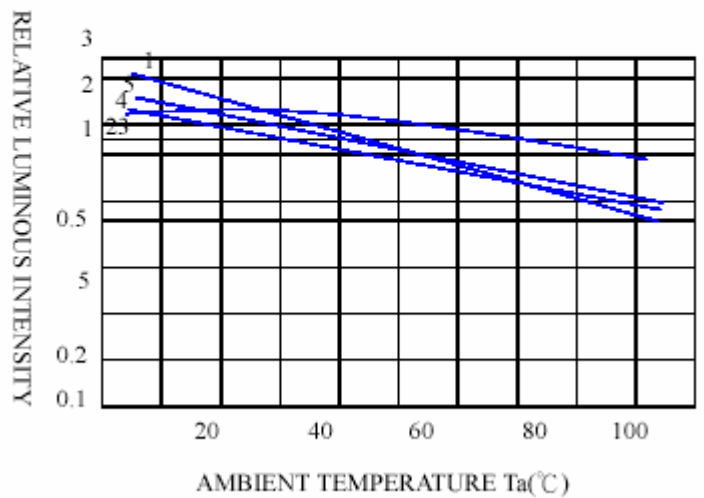
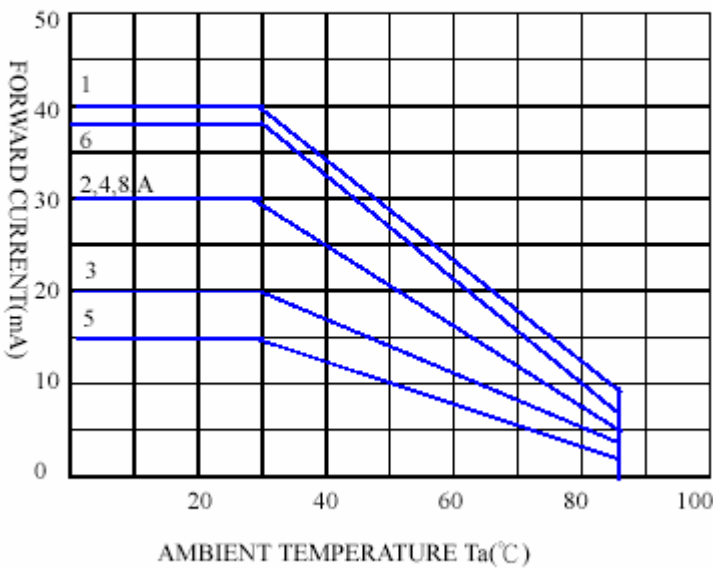

Part No.

AL-33-01UY5C

Diff No.

3 mm

High Power

Type : LED Lamps

Precautions For Use

1. Over-current proof

Customer must apply resistors for protection, otherwise slight voltage shift will cause big current change (Burn out will happen).

2. Storage

2.1 Do not open moisture proof bag before the products are ready to use.

2.2 Before opening the package, the LEDs should be kept at 30°C or less and 90%RH or less.

2.3 The LEDs should be used within a year.

2.4 After opening the package, the LEDs should be kept at 30°C or less and 70%RH or less.

2.5 The LEDs should be used within 168 hours (7 days) after opening the package.

2.6 If the moisture absorbent material (silica gel) has faded away or the LEDs have exceeded the storage time, baking treatment should be performed using the following conditions.

Baking treatment : 60±5°C for 24 hours.

3. Soldering Condition

3.1 Pb-free solder temperature profile

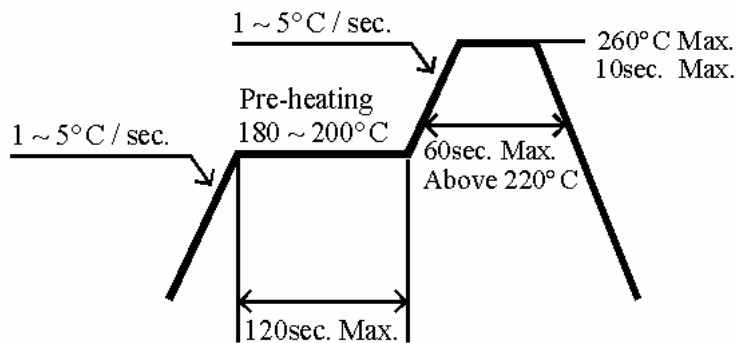

3.2 Reflow soldering should not be done more than two times.

3.3 When soldering, do not put stress on the LEDs during heating.

3.4 After soldering, do not warp the circuit board.

4. Soldering Iron

Each terminal is to go to the tip of soldering iron temperature less than 280°C for 3 seconds within once in less than soldering iron capacity 25W. Leave two seconds and more intervals, and do soldering of each terminal. Be careful because the damage of the product is often started at the time of the hand solder.