

Industrial Grade AC/DC Power Supply With PFC

| | | | | |
|------------------------------|--|----------------------------|---------------------------|------------------------------------|
| 85-264 Vrms Input Voltage | 12/24/36/48 V Semi-Regulated Output | 400 W Output Continuous | 500 W Output Transient | Up to 91 % Full Load Efficiency |
|------------------------------|--|----------------------------|---------------------------|------------------------------------|

Includes 5 V (10 W) and 12 V (50 W) "Always On" Standby Power Outputs



400 W Open Frame

ACuQor[®]



1200 W Encased Stacked



400 W Encased

Configurations

- 400 W Encased or Open Frame
- 800 W Encased Flat or Stacked
- 1200 W Encased Flat or Stacked



800 W Encased Flat

400 W Triple Vout Series Features

- High efficiency (91% for 48 VOUT Model at 400 W)
- Universal input voltage range
- Semi-regulated output for bus stability
- Parallel operation supported
- Integral fan cooling with speed control
- Active PFC; EN61000-3-2 compliant
- Low leakage; EN60601-1 compliant
- Low noise; EN55011 / EN55022 Class B compliant
- Over-current, over-voltage, and over-temp protection
- DC Power Good / AC Power Good signals
- Remote enable input
- Fan status output / Fan enable input
- Small size: 3" x 5" x 1.45" (open frame)
- RoHS 6/6 compliant
- 5 V (250 mW) standby output



Technical Specification

AC Input: 85-264 V_{RMS}
DC Output: 12/24/36/48V Semi-reg.
Power: 400 W Series
Grade: Industrial

ACuQor 400W Triple Vout Series ELECTRICAL CHARACTERISTICS

All specifications typical with T_A = 25 °C, unless otherwise specified.

| MAIN OUTPUT SPECIFICATIONS | | |
|--|--|---|
| Output power (continuous) (5 s transient) | 85-132/170-264 Vrms 85-132/170-264 Vrms 132-170 Vrms | 400 W (Note 1) 500 W (Note 1) See Figure 10 |
| Nominal DC output voltage (at 250W) (Semi-regulated) | 12 Vout (model 1T) 24 Vout (model 2T) 36 Vout (model 3T) 48 Vout (model 4T) | 12.4 V 25 V 37.5 V 50 V |
| Efficiency (see figs. 1, 3, 5, 7) (see Note 1) | 12 Vout, 115 Vrms, 400 W 48 Vout, 115 Vrms, 400 W 12 Vout, 230 Vrms, 400 W 48 Vout, 230 Vrms, 400 W | 88% typ. 90% typ. 89% typ. 91% typ. |
| Hold-up time (to -20%) (see Note 1) | 12 Vout 24 / 36 / 48 Vout | 16 ms @ 400 W 20 ms @ 400 W |
| Maximum load capacitance | 12 Vout 24 Vout 36 Vout 48 Vout | 16,000 µF 8,000 µF 4,000 µF 2,000 µF |
| Output ripple voltage | Switching frequency (20 MHz BW) Twice line frequency (at 300W) | 0.5% p-p 5.0% p-p |
| Turn-on delay | | 2 s max. |
| Transient response | Iout steps from 50-75% At 0.2 A/µs | 3% typ / 6% max. dev. 100 ms recovery |
| Overvoltage protection | Cyclic restart | 110-120% |
| Short circuit protection | Cyclic operation | 115% rated Iout |
| Total regulation | Over line, load and temperature | ±6.0% |
| 12V_STANDBY cross-reg. | ΔVout caused by 50 W step | 0.5% |
| 5V_STANDBY cross-reg. | ΔVout caused by 10 W step | 0.1% |
| Thermal protection | Automatic recovery | +125 °C (PCB Temp) |
| REMOTE_ENABLE | Input Low Voltage Input High Voltage | 0.45 V (max) 4.15 V (min) |

| 12V_STANDBY OUTPUT SPECIFICATIONS | | |
|-----------------------------------|---|--------------------|
| Output power | 85-264 Vrms | 50 W |
| Nominal DC output voltage | Semi-regulated | 12.4 V |
| Total regulation | Over line, load and temperature | ±6.0% |
| Main output cross-reg. | Δ12V_STANDBY caused by Δ350W on main output | 400 mV |
| Output ripple | Switching frequency (20 MHz BW) Twice line frequency | 10 mV 0.45 Vrms |
| Output current | Continuous | 4.2 A |
| Short circuit protection | Cyclic operation | 5.0 A |
| Maximum load capacitance | | 2,000 µF |

| 5V_STANDBY OUTPUT SPECIFICATIONS | | |
|----------------------------------|---------------------------------|----------|
| Output power | 85-264 Vrms | 10 W |
| Nominal DC output voltage | Fully regulated | 5.0 V |
| Total regulation | Over line, load and temperature | ±5.0% |
| Output current | Continuous | 2.0 A |
| Short circuit protection | Cyclic operation | 2.5 A |
| Maximum load capacitance | | 1,000 µF |

| INPUT SPECIFICATIONS | | |
|-------------------------------|--------------------------------------|------------------|
| AC input voltage | Universal range | 85-264 Vrms |
| Input frequency | | 47-63 Hz |
| Input current (see Note 1) | 115 Vrms @ 400 W 230 Vrms @ 400 W | 4 Arms 2 Arms |
| Power factor | | >0.98 |
| Input surge current | 264 Vrms (cold start) | 40 A max. |
| Internal input fuses | Both AC lines | 6.3 A |

| GENERAL SPECIFICATIONS | | |
|--|-----------------------------|---|
| Fundamental ripple freq. | Input Output | 500 kHz 250 kHz |
| Audible noise | Fan speed varies with temp. | 39 dBA @ 1 m max. |
| Weight (EA \ EC) (SC \ RC) (UC \ TC) | | 343 g (12.1 oz) \ 446 g (15.7 oz) 846 g (29.8 oz) \ 879 g (31 oz) 1224 g (43.2 oz) \ 1298 g (45.8 oz) |
| MTBF | MIL-217 Demonstrated | 343.6 kHours TBD kHours |

| ISOLATION SPECIFICATIONS | | |
|--------------------------|--|------------------------------------|
| Isolation voltage | Input to output Input to ground Output to ground | 3000 Vrms 1500 Vrms 500 Vrms |
| Insulation resistance | Output to ground | 10 MΩ min. |
| Leakage currents | | See Note 2 |

| ENVIRONMENTAL CHARACTERISTICS | | |
|-------------------------------|---|------------------------------------|
| Thermal performance | Operating ambient (see Figure 9) Non-operating ambient | 0 °C to +70 °C -40 °C to +85 °C |
| Relative humidity | Non-condensing | 5-95% RH |
| Altitude | Operating Non-operating | 10,000 ft max. 30,000 ft max. |
| Random vibration | 5-500 Hz | 0.03 g ² /Hz |
| Shock | Half-sine, 10 ms, 3 axes | 20 g peak |

| EMC CHARACTERISTICS | | |
|--------------------------|------------------------------------|---|
| Conducted emissions | EN55011 and EN55022, FCC part15 | Level B |
| Line frequency harmonics | EN61000-3-2 | Class A |
| Voltage fluctuations | EN61000-3-3 | Clause 5b |
| ESD air | EN61000-4-2 | Level 3 |
| ESD contact | EN61000-4-2 | Level 3 |
| Radiated immunity | EN61000-4-3 | Level 3 |
| Fast transients | EN61000-4-4 | Level 3 |
| Line surge immunity | EN61000-4-5 | Level 3 |
| Conducted immunity | EN61000-4-6 | Level 3 |
| Power freq. mag. field | EN61000-4-8 | 3 A/m |
| Voltage dip immunity | EN61000-4-11 | Perf Criteria A, A, B <5% UT 10 ms, 70% UT 500 ms, 40% UT 100 ms |

| SAFETY AGENCY CERTIFICATIONS (pending) | |
|---|--|
| All certification marks appear on individual unit labels. | |
| UL60950 | |
| IEC/EN 60950 | |
| CE Marked | |
| cUL CSA Standards | |

- NOTES:
 1. Main output power rating always includes 5 V and 12 V standby outputs.
 2. Leakage currents:

| AC Leakage Current from Input to Earth | AC Line Connection | Normal Condition | Open Neutral Fault |
|--|-------------------------------------|---------------------|-----------------------|
| ACuQor Typical at 110% nominal input voltage 60 Hz | 240 V L-N, 1 phase | 400 µA | 800 µA |
| | 208 V L-L, 120 V L-N, 1 of 3 phases | 200 µA | 400 µA |
| | 240 V L-N-L, 120 V L-N, split phase | 200 µA | 400 µA |

EFFICIENCY, DERATING, AND V_{OUT} DROOP CURVES

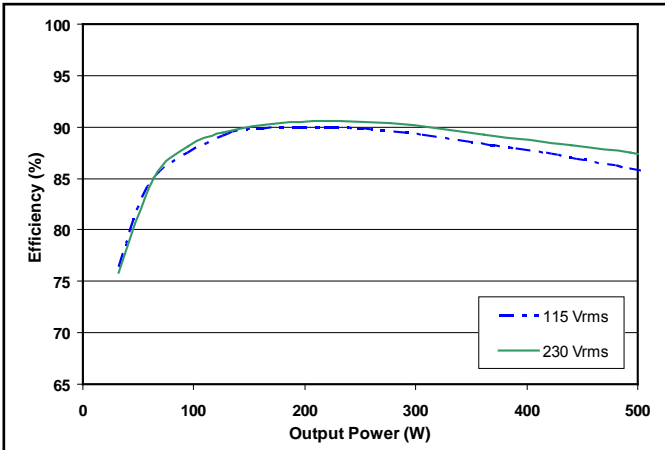

Figure 1: 12 V_{OUT} efficiency curves.

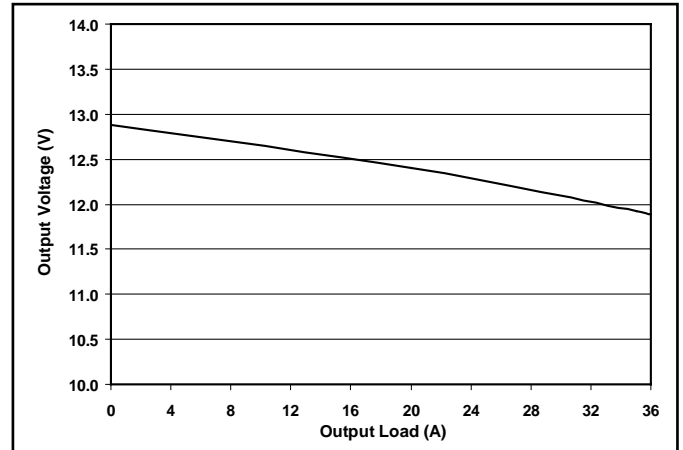

Figure 2: 12 V_{OUT} droop characteristic.

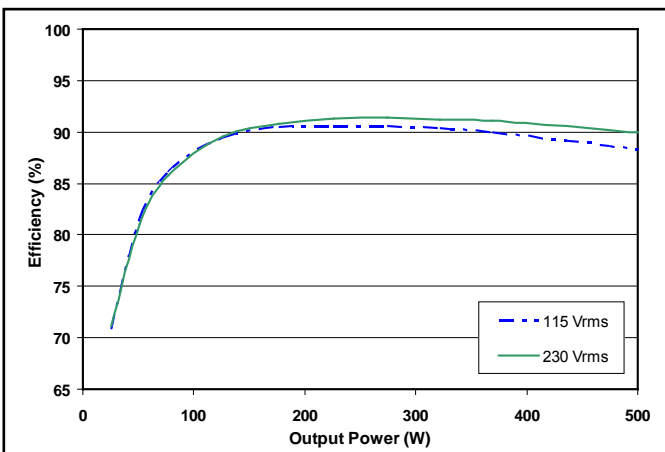

Figure 3: 24 V_{OUT} efficiency curves.

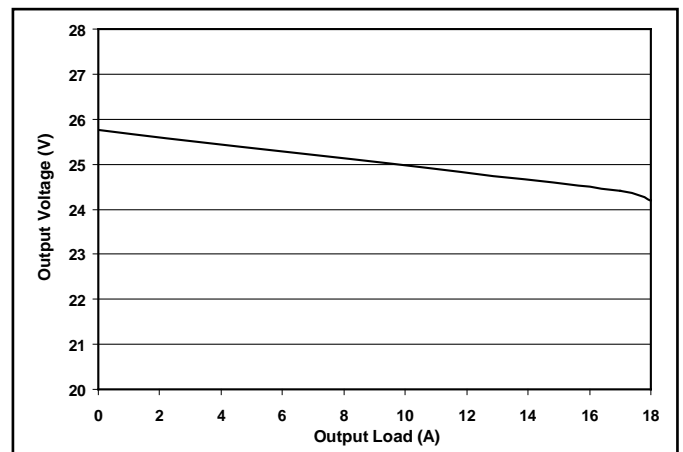

Figure 4: 24 V_{OUT} droop characteristic.

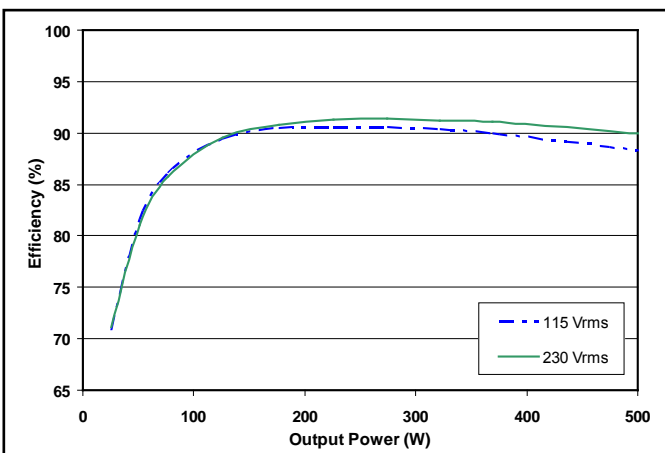

Figure 5: 36 V_{OUT} efficiency curves.

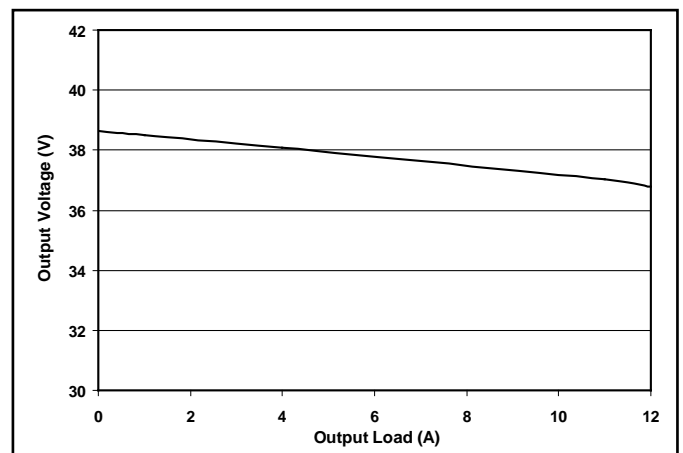

Figure 6: 36 V_{OUT} droop characteristic.

EFFICIENCY, DERATING, AND V_{OUT} DROOP CURVES

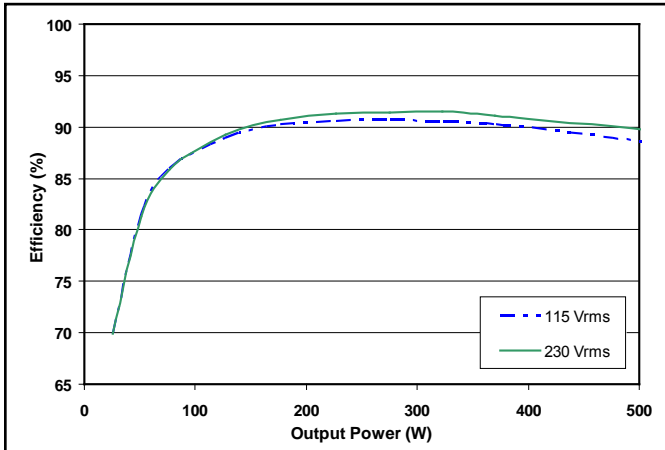

Figure 7: 48 V_{OUT} efficiency curves.

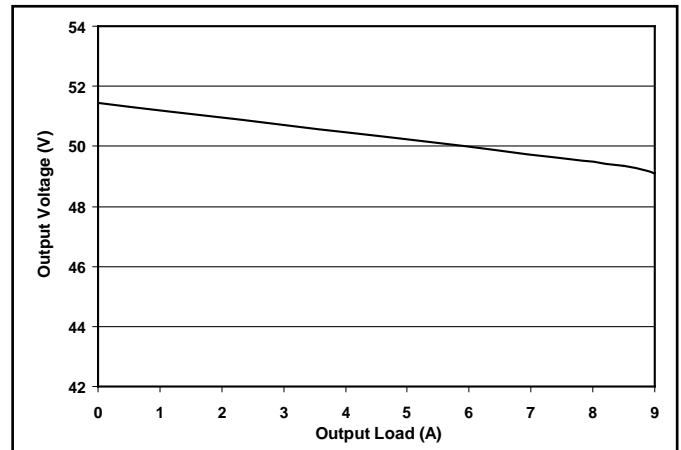

Figure 8: 48 V_{OUT} droop characteristic.

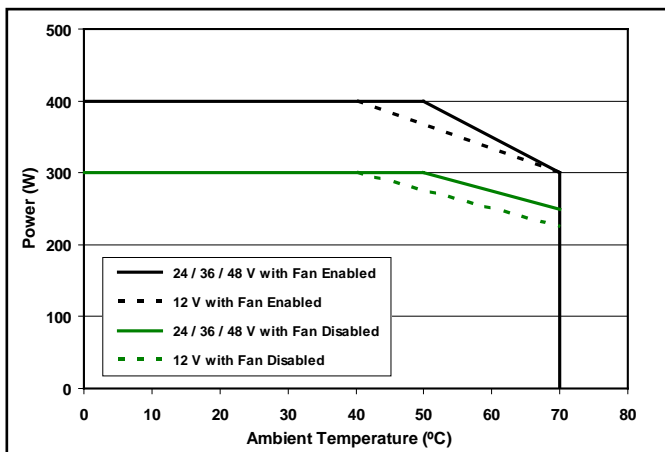

Figure 9: Continuous power derating curve in natural convection.

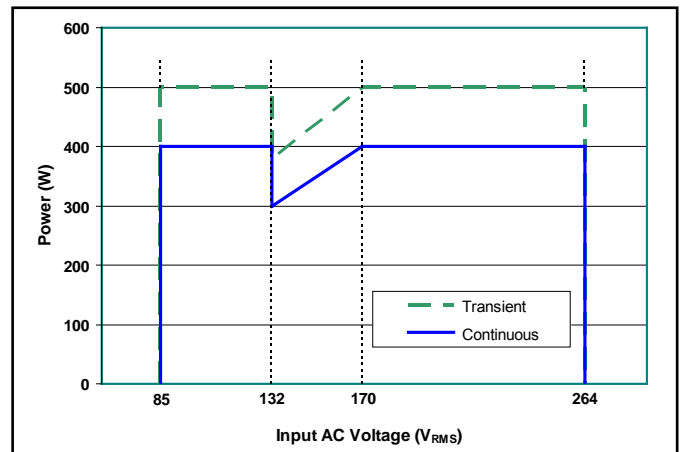

Figure 10: Rated output power vs Input AC Voltage.



Technical Specification

AC Input: 85-264 V_{RMS}
DC Output: 12/24/36/48V Semi-reg.
Power: 400 W Series
Grade: Industrial

MECHANICAL DRAWINGS (1 Module Open Frame Version – E Package Type)

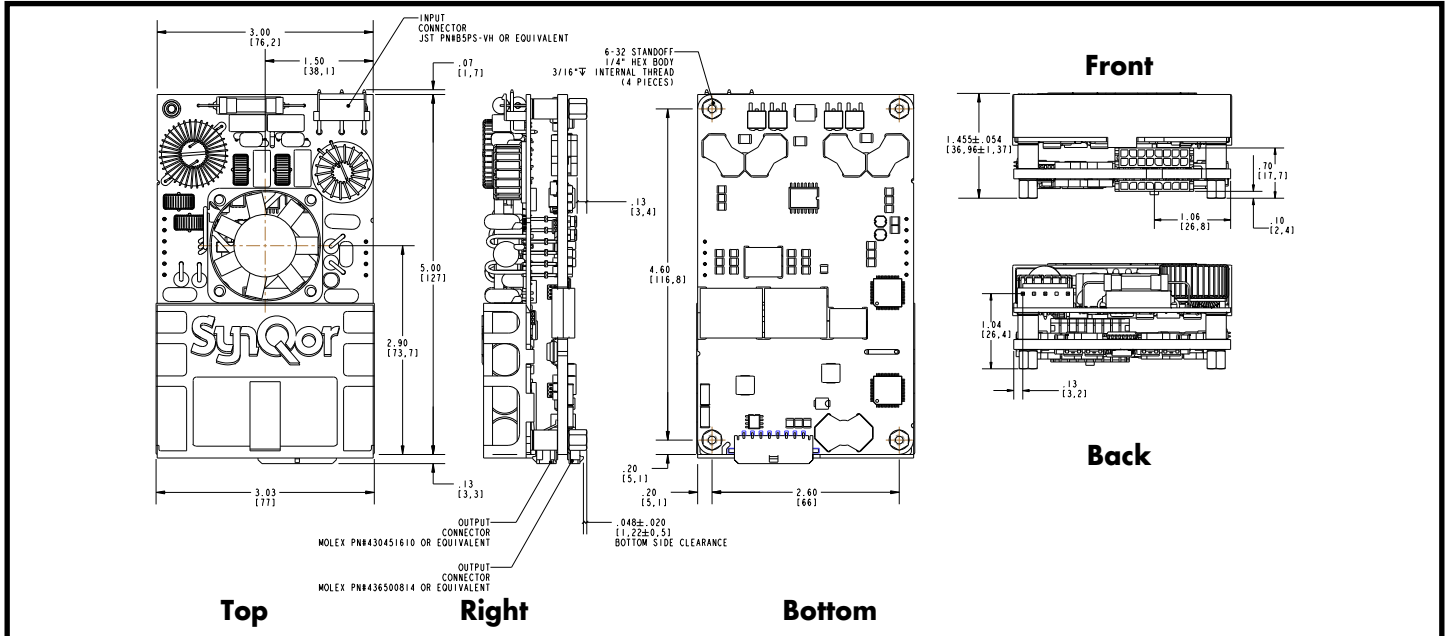

MECHANICAL DRAWINGS (1 Module Encased Version – E Package Type)

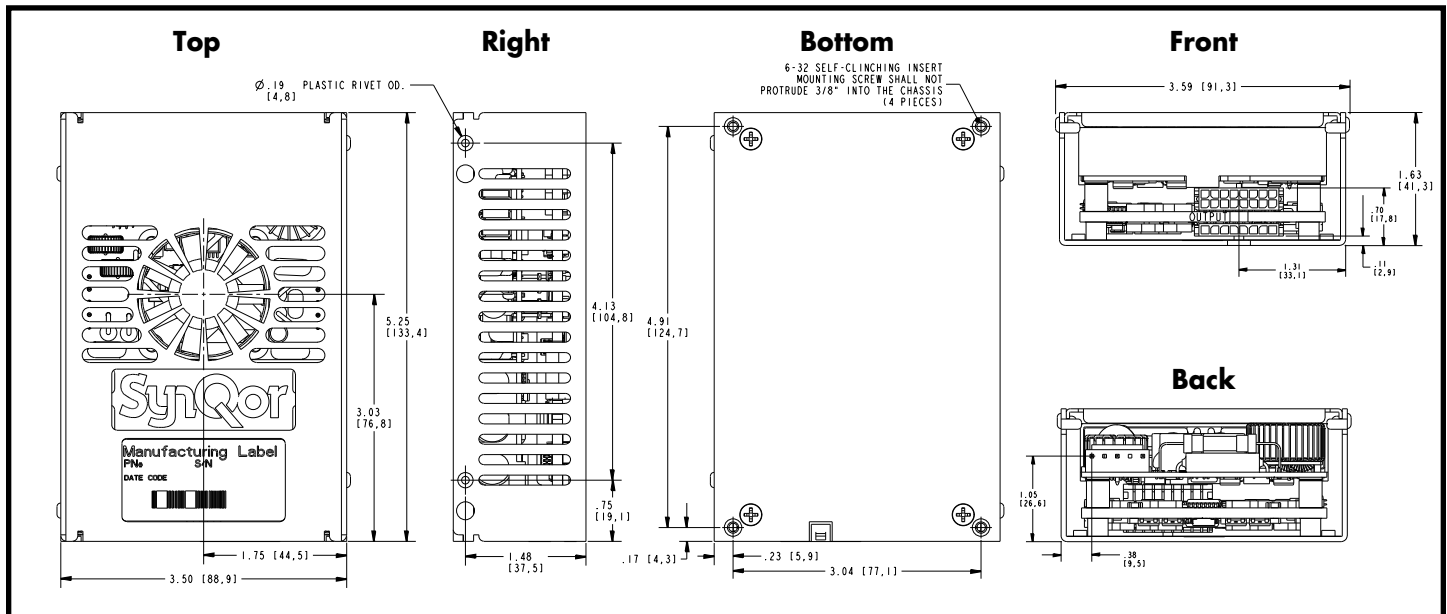

NOTES (applies to all mechanicals)

- 1) Recommended screw tightening torque of 6 in.lbs
- 2) Undimensioned components are shown for visual reference only
- 3) All dimensions in inches [mm]

Tolerances: x.xx in ± 0.02
x.xxx in ± 0.010



Technical Specification

AC Input: 85-264 V_{RMS}
DC Output: 12/24/36/48V Semi-reg.
Power: 400 W Series
Grade: Industrial

MECHANICAL DRAWINGS (2 Modules Flat Version – R Package Type)

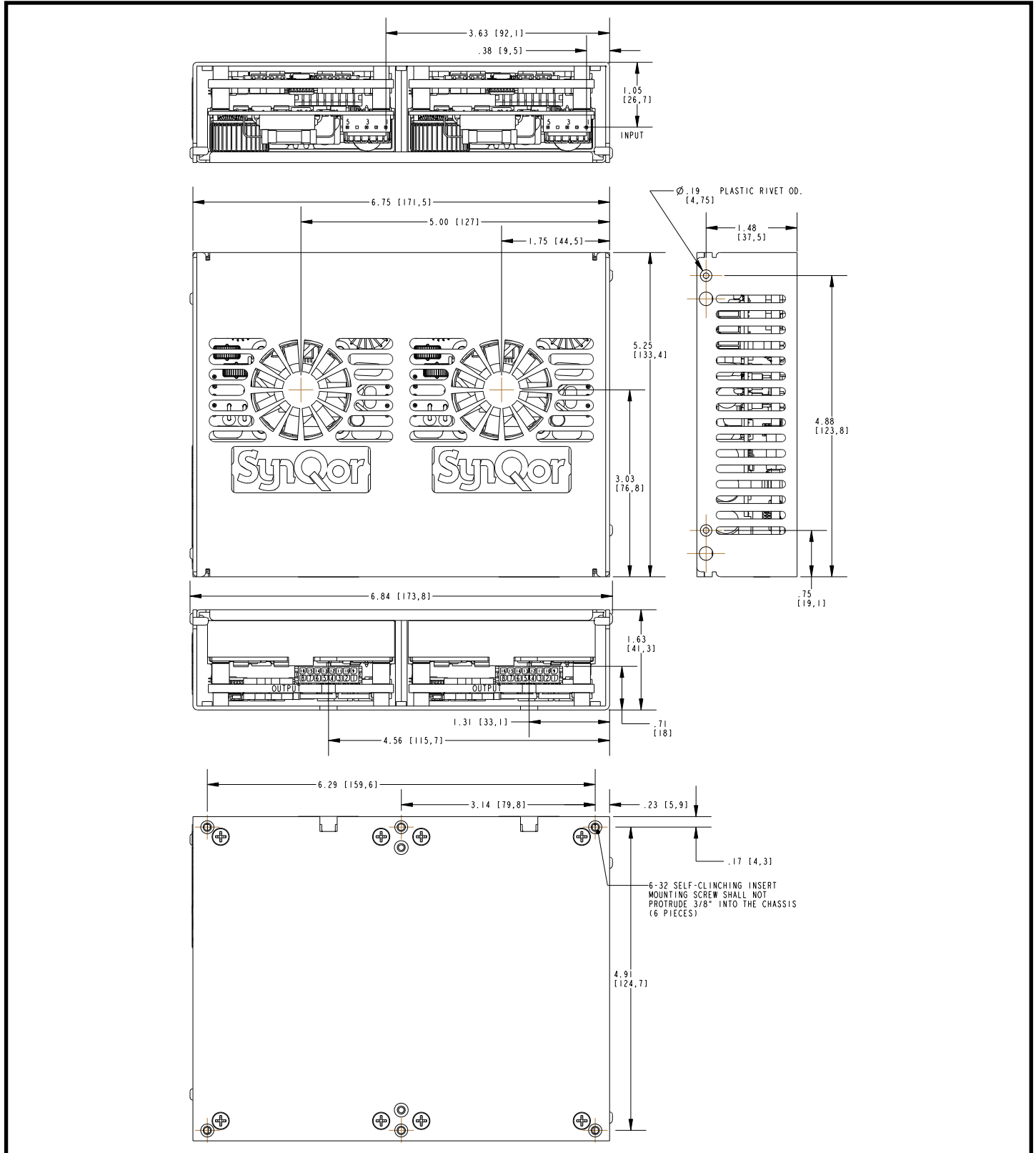



Technical Specification

AC Input: 85-264 V_{RMS}
DC Output: 12/24/36/48V Semi-reg.
Power: 400 W Series
Grade: Industrial

MECHANICAL DRAWINGS (3 Modules Flat Version – T Package Type)

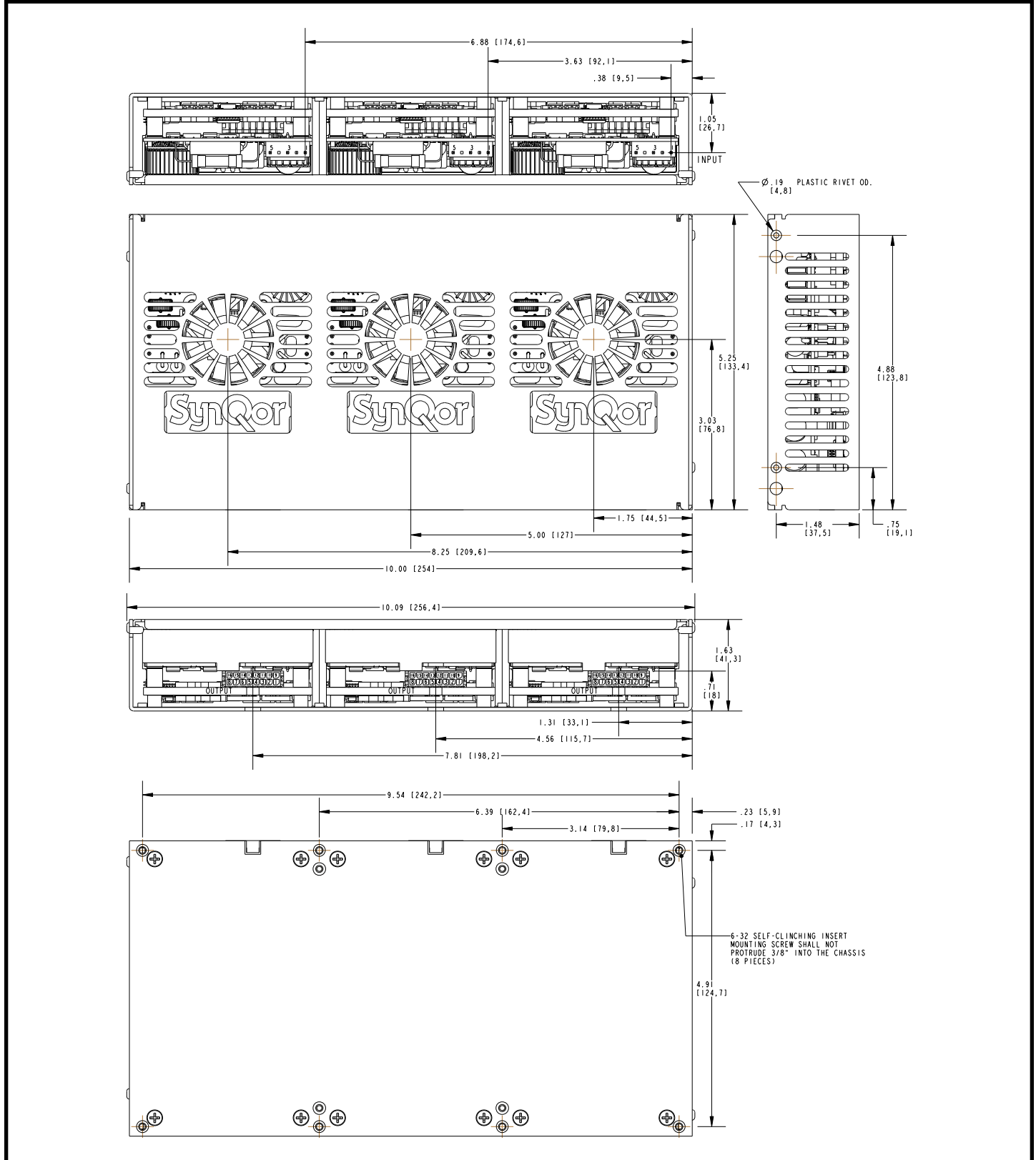



Technical Specification

AC Input: 85-264 V_{RMS}
DC Output: 12/24/36/48V Semi-reg.
Power: 400 W Series
Grade: Industrial

MECHANICAL DRAWINGS (3 Modules Stacked Version – U Package Type)

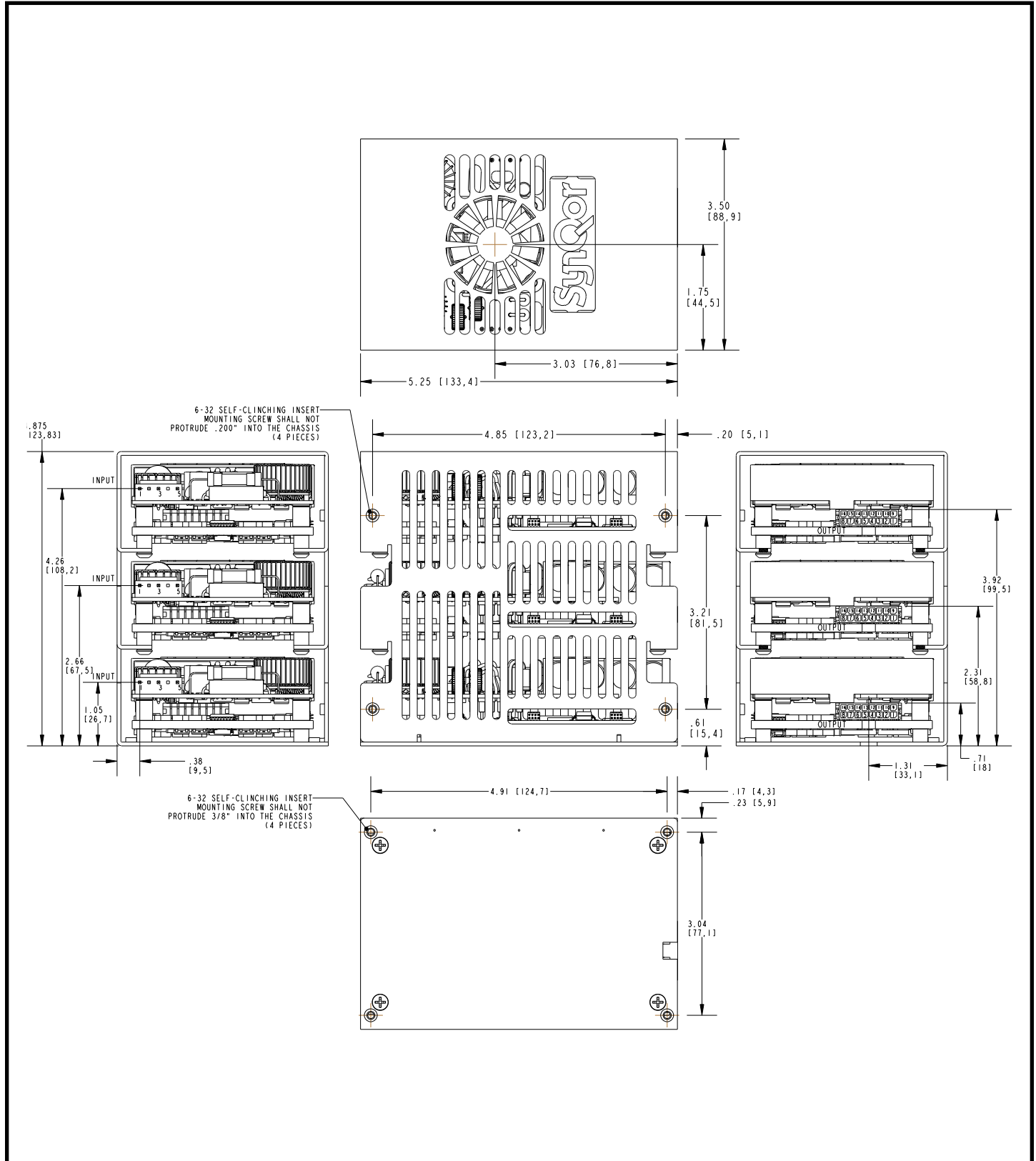

CONNECTOR DETAILS

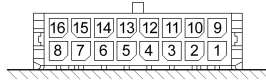

OUTPUT CONNECTOR PINOUT (top side)

| | | |
|--------|---------------|---|
| Pin 1 | FAN_GOOD | Open collector with internal 5V pullup. See Figure A. Pulsed low on fan failure, 100ms, 50% duty. Short to VOUT(-) to disable fan. |
| Pin 2 | AC_POWER_GOOD | Open collector with internal 5V pullup. See Figure B. Pulled low on AC power dropout. |
| Pin 3 | DC_POWER_GOOD | Open collector with internal 5V pullup. See Figure B. Pulled low during startup ramp and within 5 °C of temperature shutdown threshold. |
| Pin 4 | 5V_STANDBY | 5 V @ 10 W available whenever AC power is applied. |
| Pin 5 | VOUT(+) | Positive Output Voltage. |
| Pin 6 | VOUT(+) | Positive Output Voltage. |
| Pin 7 | VOUT(+) | Positive Output Voltage. |
| Pin 8 | VOUT(+) | Positive Output Voltage. |
| Pin 9 | Reserved | Reserved for future use. |
| Pin 10 | Reserved | Reserved for future use. |
| Pin 11 | REMOTE_ENABLE | Logic input. See Figure C. Pull high to enable main output. |
| Pin 12 | 12V_STANDBY | 12 V @ 50 W available whenever AC power is applied. |
| Pin 13 | VOUT(-) | Negative Output Voltage. |
| Pin 14 | VOUT(-) | Negative Output Voltage. |
| Pin 15 | VOUT(-) | Negative Output Voltage. |
| Pin 16 | VOUT(-) | Negative Output Voltage. |



12 V OUTPUT CONNECTOR PINOUT (bottom side)

| | | |
|-------|---------|--------------------------|
| Pin 1 | VOUT(+) | Positive Output Voltage. |
| Pin 2 | VOUT(+) | Positive Output Voltage. |
| Pin 3 | VOUT(+) | Positive Output Voltage. |
| Pin 4 | VOUT(+) | Positive Output Voltage. |
| Pin 5 | VOUT(-) | Negative Output Voltage. |
| Pin 6 | VOUT(-) | Negative Output Voltage. |
| Pin 7 | VOUT(-) | Negative Output Voltage. |
| Pin 8 | VOUT(-) | Negative Output Voltage. |

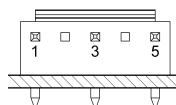

INDIVIDUAL INPUT CONNECTOR PINOUT

| | |
|-------|------------|
| Pin 1 | Ground |
| Pin 3 | AC Neutral |
| Pin 5 | AC Line |

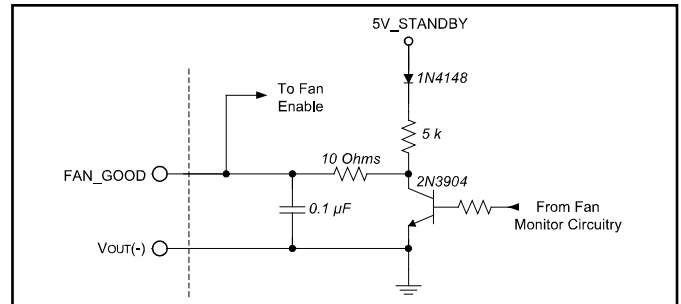

Figure A: Fan status output / Fan enable input interface circuitry.

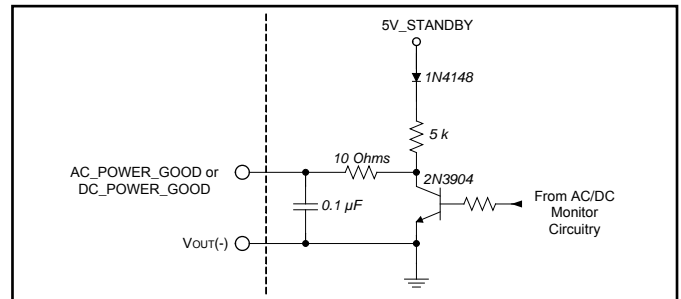

Figure B: Power good interface circuitry.

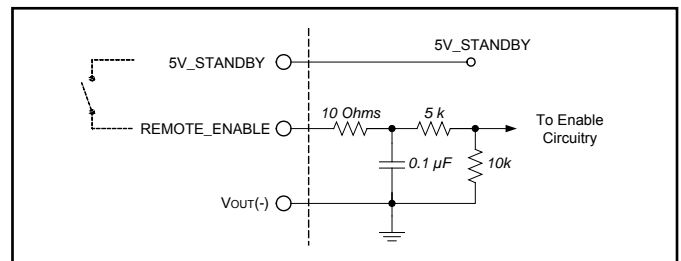

Figure C: Remote enable interface circuitry.

MATING CONNECTORS

| Connector | Type | Contact |
|---------------------|-----------------|------------------|
| OUTPUT (16 pins) | Molex 430251600 | Molex 430300008* |
| 12V_OUTPUT (8 pins) | Molex 436450800 | Molex 430300008* |
| INPUT | JST VHR-5N | JST SVH-41T-P1.1 |

* Each contact rated for a maximum of 5.5 A.



Technical Specification

AC Input: 85-264 V_{RMS}
DC Output: 12/24/36/48V Semi-reg.
Power: 400 W Series
Grade: Industrial

PARALLEL OPERATION - MULTIPLE UNITS

Chassis configurations for Parallel Units

ACuQor units are available either open-frame or pre-mounted at the factory. Up to 3 units can be mounted into a chassis, in either side-by-side or stacked configurations. For a complete list of options, see the "Part Numbering System" table on the last page, under "Package Type", along with the Mechanical Drawings pages. Only side-by-side configurations can be populated with 500W units, since each includes a thermal pad underneath.

Interconnection of Parallel Units

ACuQor units mounted in 2 and 3 unit chassis are not connected together. This allows the physical routing and connectivity of the external wiring to be customized to each application. The following table summarizes the recommended wiring to operate multiple units in parallel:

Specifications of Parallel Units

As a rule, units wired in parallel behave the same as single units. Any specification will remain unchanged that is expressed in units of voltage, time, frequency, or efficiency. Specifications expressed in terms of power, current, or capacitance, should be scaled by the number of units wired in parallel.

ACuQor units are individually calibrated at the factory, so that the output voltage vs. output current characteristic is always consistent (see Vout droop characteristic figures). As such, multiple units will share output current accurately. Full current is guaranteed from a bank of multiple units wired in parallel.

| Output Connector Signal | Suggested Connection | Behavior with Multiple Units |
|-------------------------|-------------------------|--|
| REMOTE_ENABLE | Wire in parallel | Inputs activated simultaneously |
| FAN_GOOD | " | Wired-OR outputs – can be pulled low by any unit during an abnormal condition. |
| AC_POWER_GOOD | " | " |
| DC_POWER_GOOD | " | " |
| VOUT(+), VOUT(-) | " | Built-in droop characteristic ensures graceful current sharing. |
| 12V_STANDBY* | " | " |
| 5V_STANDBY | Do not wire in parallel | Fully regulated characteristic does not support current sharing. If placed in parallel, only the output with the highest set-point will drive current. |

*Note: Triple output models only.



Technical Specification

AC Input: 85-264 V_{RMS}
DC Output: 12/24/36/48V Semi-reg.
Power: 400 W Series
Grade: Industrial

INSTALLATION INSTRUCTIONS

General: ACuQor AC/DC power supplies are intended for use as components in industrial equipment. ACuQor units must be properly installed within end use equipment before they can be safely applied as described in this document. The suitability of the ACuQor/equipment combination must be verified through end product investigation.

Mounting: Refer to the Mechanical Drawings section. ACuQor units are provided with threaded stainless-steel stand-offs or inserts for mounting. This mounting hardware is internally connected to the input connector protective-earth terminal for functional-earth EMC control. Any orientation (vertical, horizontal, etc.) may be used. Adequate air space should be provided over the fan intake (top) and exhaust (sides) to allow for exchange of cooling air. ACuQor is designed for a pollution degree 2 environment. The suitability of the enclosed ACuQor mechanical assemblies must be verified through end product investigation.

Encased models: A minimum of 5 mm electrical clearance should be allowed from the connector ends of encased models.

Input: Refer to the Connector Details section for input connector wiring. ACuQor products require a single phase AC power source of 100-240V 50/60Hz nominal. Refer to nameplate label for input current ratings. A protective-earth connection is also required. Minimum wire size of 18 AWG (0.8mm²) is recommended. Both sides of the AC line are internally fused (see table for specific models). These fuses are not user replaceable.

Output: Refer to the Connector Details section for output connector wiring and signal I/O functionality. Refer to nameplate label for output current ratings. Main DC output (Vout+, Vout-) pins should use 20 AWG (0.5mm²) wire size. Individual main output pins should not be loaded to more than 5.5 A. For currents greater than 5.5 A, multiple main output pins/wires must be used in parallel. All signal I/O pins are referenced to Vout-.

EMC: ACuQor products have been tested to the EMC specifications listed in the Electrical Characteristics section. However, end use equipment must be tested to verify EMC compliance.

Hipot Testing: ACuQor products are rated for Hipot testing levels of 1500 Vac input to protective-earth, 500 Vac output to protective-earth, and 3000 Vac input to output. When performing the 3000 Vac input to output test, the test voltage must be balanced evenly 1500 Vac input and output to protective-earth. Two oppositely phased test voltage sources or a single test voltage source with external balancing impedances (capacitors) may be used to prevent overstressing input or output to protective-earth insulation per IEC/ENC 60950-1.

| MODEL | Input Fuses (in Both AC Lines) | Fuses Total |
|--------|---------------------------------|-------------|
| AQ0300 | Littelfuse 6.3A 250V 21606.3XEP | 2 |
| AQ0400 | Littelfuse 6.3A 250V 21606.3XEP | 2 |
| AQ0500 | Littelfuse 10.0A 250V 216010XEP | 2 |



Technical Specification

AC Input: 85-264 V_{RMS}
DC Output: 12/24/36/48V Semi-reg.
Power: 400 W Series
Grade: Industrial

PART NUMBERING SYSTEM

The part numbering system for SynQor's ACuQor AC/DC power supplies follows the format shown in the table below. Not all combinations make valid part numbers, please contact SynQor for availability.

| Family | Output Power | Grade | Range | Output Voltage (xx=Standard; xT=Triple) | Package Type (Correlates to Output Power) | Thermal Design | Options |
|--|---|---------------|--|--|--|---|--|
| AQ ACuQor series of ac-dc semi-regulated output power supplies | 0300: 300 W 0400: 400 W 0500: 500 W 0600: 600 W (2 x 300 W) 0800: 800 W (2 x 400 W) 0900: 900 W (3 x 300 W) 1000: 1000 W (2 x 500 W) 1200: 1200 W (3 x 400 W) 1500: 1500 W (3 x 500 W) | I: industrial | U: universal (85-264 V _{RMS}) | 12: 12 V 1T: 12 V / 5 & 12 V STBY 24: 24 V 2T: 24 V / 5 & 12 V STBY 36: 36 V 3T: 36 V / 5 & 12 V STBY 48: 48 V 4T: 48 V / 5 & 12 V STBY | E: 1 unit (3" x 5") R: 2 units; flat S: 2 units; stacked T: 3 units; flat U: 3 units; stacked | A: open frame C: encased Q: encased only | Industrial Grade: IND: Industrial |

Example: AQ0400IU2TEAIND

ACCESSORIES

SynQor offers a series of assemblies that can be ordered according to the table below. Mechanical drawings for these accessories are available for download in pdf format from the SynQor website.

| Part Number | Description |
|----------------|--|
| AQ-CBL-INPUT1C | Input mating cable with pre-stripped wire ends (36" long). |
| AQ-CBL-OUT1C | Output mating cable with pre-stripped wire ends (18" long). |
| AQ-CBL-OUT1CD | Same as AQ-CBL-OUT1C with an additional 8-pin connector. |
| AQ-CBL-OUT2C | Output mating cable with connectors on both ends (18" long). |
| AQ-CBL-OUT2CD | Same as AQ-CBL-OUT2C with an additional 8-pin connector. |
| AQ-INSUL1M | Single module bottom-side Mylar insulator for open frame mounting. |
| AQ-EVAL-PRL3 | Evaluation board for up to three paralleled modules. |

APPLICATION NOTES

A variety of application notes and technical white papers can be downloaded in pdf format from the SynQor website.

PATENTS

SynQor holds the following patents, one or more of which might apply to this product:

| | | | |
|-----------|-----------|-----------|-----------|
| 5,999,417 | 6,222,742 | 6,545,890 | 6,577,109 |
| 6,594,159 | 6,731,520 | 6,894,468 | 6,896,526 |
| 6,927,987 | 7,050,309 | 7,072,190 | 7,085,146 |
| 7,119,524 | 7,269,034 | 7,272,021 | 7,272,023 |

Contact SynQor for further information:

Phone: 978-849-0600
Toll Free: 888-567-9596
Fax: 978-849-0602
E-mail: power@synqor.com
Web: www.synqor.com
Address: 155 Swanson Road
 Boxborough, MA 01719, USA

Warranty: SynQor offers a two (2) year limited warranty. Complete warranty information is listed on our website or is available upon request from SynQor.

Limitation on use: SynQor's products are not authorized for use and should not be used, without the specific prior written approval of an authorized officer of SynQor making specific reference hereto, in any life support system, nuclear facility or application, aircraft control application or any other application in which failure of the product could reasonably result in harm to life, property or the environment.

Information furnished by SynQor is believed to be accurate and reliable. However, no responsibility is assumed by SynQor for its use, nor for any infringements of patents or other rights of third parties which may result from its use. No license is granted by implication or otherwise under any patent or patent rights of SynQor.