

CRD5490-Z Power Monitor

Features

- Easy-to-use Power Monitoring Reference Design
 - Plug one side into a wall outlet and an electric load into the other side.
 - Read real time measurements on the PC GUI via USB in seconds.
- Real Time Measurements:
 - Line Voltage
 - Load Current
 - Active Power
 - Reactive Power
 - Apparent Power
 - Power Factor
 - Fundamental Line Frequency
 - Temperature
- Operational Voltage 90VAC to 260VAC
- Maximum RMS Load Current 15A
- Factory Calibrated and Recalibration Capable
- Compact AC/DC Buck Converter
- Onboard PIC18 Microcontroller
- Windows® GUI Software

Overview

The CRD5490-Z is designed to evaluate the functionality and performance of the CS5490 power/energy measurement device. The CRD5490-Z integrates an efficient and compact AC/DC drop capacitor/buck power supply, voltage and current sensors, and low-cost USB MCU. This compact, complete power monitor system integrates easily in any design evaluation.

The CRD5490-Z was designed with a graphical user interface (GUI) for power measurements and calibration execution. A full-featured GUI is provided to access real time line voltage, load current, active power, reactive power, apparent power, power factor, and temperature. The software provides full access and control of the CS5490 calibration and configuration without having to learn specialized commands.

ORDERING INFORMATION

CRD5490-Z Reference Design



Danger
High Voltage

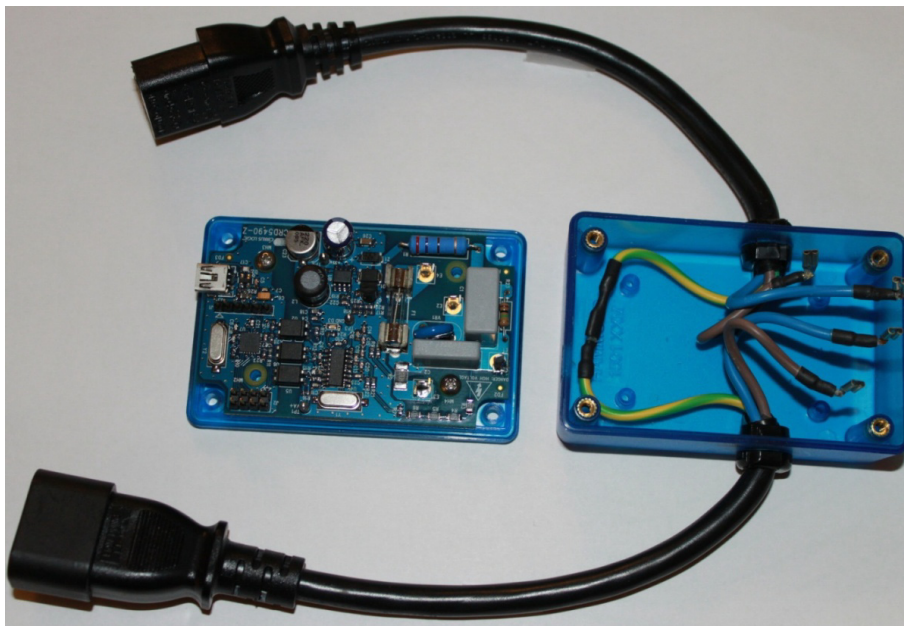

Danger
High Voltage



IMPORTANT SAFETY INSTRUCTIONS

Read and follow all safety instructions prior to using this demonstration board.

This Engineering Evaluation Unit or Demonstration Board must only be used for assessing IC performance in a laboratory setting. This product is not intended for any other use or incorporation into products for sale.

This product must only be used by qualified technicians or professionals who are trained in the safety procedures associated with the use of demonstration boards.

⚠ DANGER Risk of Electric Shock

- The direct connection to the AC power line and the open and unprotected boards present a serious risk of electric shock and can cause serious injury or death. Extreme caution needs to be exercised while handling this board.
- Avoid contact with the exposed conductor or terminals of components on the board. High voltage is present on exposed conductor and it may be present on terminals of any components directly or indirectly connected to the AC line.
- Dangerous voltages and/or currents may be internally generated and accessible at various points across the board.
- Charged capacitors store high voltage, even after the circuit has been disconnected from the AC line.
- Make sure that the power source is off before wiring any connection. Make sure that all connectors are well connected before the power source is on.
- Follow all laboratory safety procedures established by your employer and relevant safety regulations and guidelines, such as the ones listed under, OSHA General Industry Regulations - Subpart S and NFPA 70E.

⚠ WARNING Suitable eye protection must be worn when working with or around demonstration boards. Always comply with your employer's policies regarding the use of personal protective equipment.

⚠ WARNING All components and metallic parts may be extremely hot to touch when electrically active.

Contacting Cirrus Logic Support

For all product questions and inquiries contact a Cirrus Logic Sales Representative. To find the one nearest to you go to www.cirrus.com

IMPORTANT NOTICE

Cirrus Logic, Inc. and its subsidiaries ("Cirrus") believe that the information contained in this document is accurate and reliable. However, the information is subject to change without notice and is provided "AS IS" without warranty of any kind (express or implied). Customers are advised to obtain the latest version of relevant information to verify, before placing orders, that information being relied on is current and complete. All products are sold subject to the terms and conditions of sale supplied at the time of order acknowledgment, including those pertaining to warranty, indemnification, and limitation of liability. No responsibility is assumed by Cirrus for the use of this information, including use of this information as the basis for manufacture or sale of any items, or for infringement of patents or other rights of third parties. This document is the property of Cirrus and by furnishing this information, Cirrus grants no license, express or implied under any patents, mask work rights, copyrights, trademarks, trade secrets or other intellectual property rights. Cirrus owns the copyrights associated with the information contained herein and gives consent for copies to be made of the information only for use within your organization with respect to Cirrus integrated circuits or other products of Cirrus. This consent does not extend to other copying such as copying for general distribution, advertising or promotional purposes, or for creating any work for resale.

CERTAIN APPLICATIONS USING SEMICONDUCTOR PRODUCTS MAY INVOLVE POTENTIAL RISKS OF DEATH, PERSONAL INJURY, OR SEVERE PROPERTY OR ENVIRONMENTAL DAMAGE ("CRITICAL APPLICATIONS"). CIRRUS PRODUCTS ARE NOT DESIGNED, AUTHORIZED OR WARRANTED FOR USE IN PRODUCTS SURGICALLY IMPLANTED INTO THE BODY, AUTOMOTIVE SAFETY OR SECURITY DEVICES, LIFE SUPPORT PRODUCTS OR OTHER CRITICAL APPLICATIONS. INCLUSION OF CIRRUS PRODUCTS IN SUCH APPLICATIONS IS UNDERSTOOD TO BE FULLY AT THE CUSTOMER'S RISK AND CIRRUS DISCLAIMS AND MAKES NO WARRANTY, EXPRESS, STATUTORY OR IMPLIED, INCLUDING THE IMPLIED WARRANTIES OF MERCHANTABILITY AND FITNESS FOR PARTICULAR PURPOSE, WITH REGARD TO ANY CIRRUS PRODUCT THAT IS USED IN SUCH A MANNER. IF THE CUSTOMER OR CUSTOMER'S CUSTOMER USES OR PERMITS THE USE OF CIRRUS PRODUCTS IN CRITICAL APPLICATIONS, CUSTOMER AGREES, BY SUCH USE, TO FULLY INDEMNIFY CIRRUS, ITS OFFICERS, DIRECTORS, EMPLOYEES, DISTRIBUTORS AND OTHER AGENTS FROM ANY AND ALL LIABILITY, INCLUDING ATTORNEYS' FEES AND COSTS, THAT MAY RESULT FROM OR ARISE IN CONNECTION WITH THESE USES.

Microsoft Visual Studio, Windows 7, and Windows XP are either trademarks or registered trademarks of Microsoft Corporation.

1. CHARACTERISTICS AND SPECIFICATIONS

1.1 Recommended Operating Conditions

Parameter	Symbol	Min	Typ	Max	Unit
Reference					
Line Voltage	V_{AC}	90	-	260	V
Load Current	I_{RMS}	-	-	15	A
Peak Current	I_{PEAK}	-	-	22	A
Fundamental Frequency	Freq	5	-	2000	Hz
Ambient Operating Temperature	T_A	-40		85	°C

1.2 Electrical Characteristics

Parameter	Symbol	Min	Typ	Max	Unit
Reference					
Power Consumption ($V_{AC} = 240V, 50Hz$)	P_{AC}	-	0.6	-	W
Accuracy (PF=1, Sample Count 8000 - 2 second, Temp Compensation Enabled)					
RMS Voltage (90-260 V_{AC})	ΔV_{RMS}	-	± 0.1	-	%
RMS Current (15mA-15A)	ΔI_{RMS}	-	± 0.1	-	%
Active Power (1.5W-3900W)	ΔP_{AVG}	-	± 0.1	-	%



Danger
High Voltage

WARNING

High Voltage Hazard



Danger
High Voltage

When the CRD5490-Z is connected to AC lines, high voltage is present inside the box. Do not remove the protective cover from the CRD5490-Z when power is connected. The evaluation board connects directly to the AC power line and presents a serious risk of electric shock and can cause serious injury or death. Extreme caution needs to be exercised while handling this box. Make sure that the power source is off before wiring any connection. Make sure that all connectors are well connected before the power source is turned on. Make sure all AC power line wiring is secured to the box and away from contact before the power source is on.

Refer to additional warnings at the beginning of this document.

2. HARDWARE OVERVIEW

The CRD5490-Z includes sensors (line voltage and current shunt), a power supply, a CS5490 power monitor calculation engine, isolation, and an MCU. Figure 1 shows connections of each block.

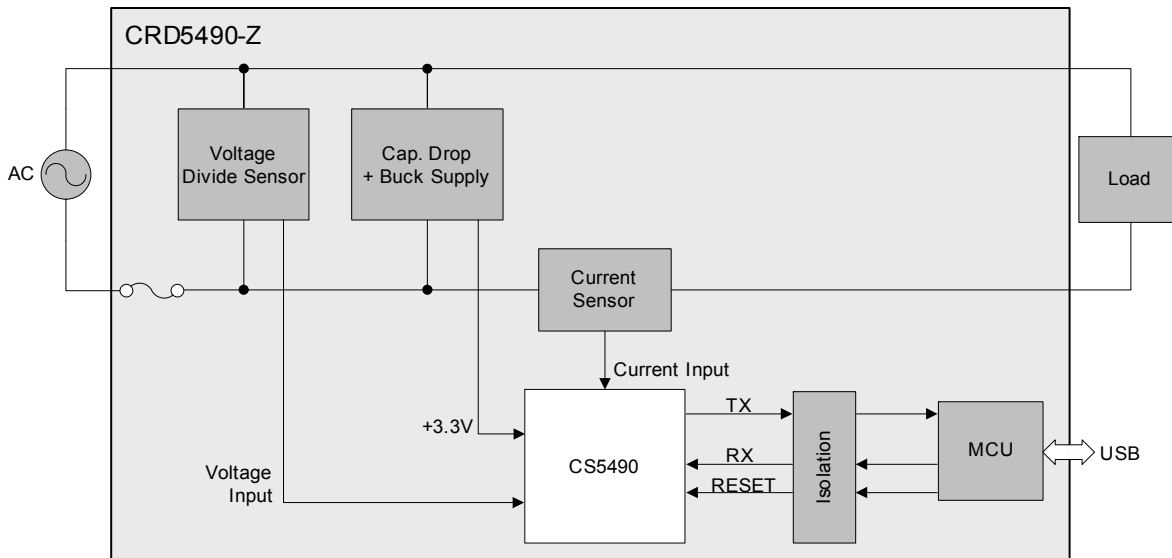

Figure 1. System Block Diagram

Make sure that the power source is off before wiring any connection. The AC source is connected to plug IEC 60320 C14, and the AC load is connected to connector IEC 60320 C13. Make sure that all connectors are well connected before the power source is turned on. Make sure all AC power line wiring is secured to the box and away from contact before the power source is on.

2.1 Line Voltage Sensor

The high-voltage AC line is attenuated using a voltage divider sensor comprised of five 1206 resistors before being supplied to the CS5490 voltage channel input. Figure 2 shows the resistor diagram for line voltage sensing. R1 is actually four large-value resistors, which increases the voltage rating. R2 is one 1K sense resistor. Refer to the vendor's specifications for voltage compliance.

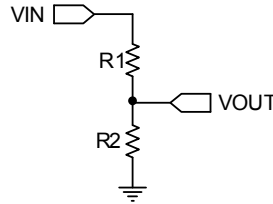

Figure 2. Voltage Sensor Attenuator

The divider ratio is determined by the maximum input range of the CS5490 voltage channel ($176\text{mV}_{\text{RMS}}$) and the maximum line voltage. The division ratio is determined by Equation 1.

$$V_{\text{OUT}} = V_{\text{IN}} \times \frac{R_2}{R_1 + R_2} < 176\text{mV}_{\text{RMS}} \quad \text{Eq. 1}$$

For a line voltage, $V_{\text{IN}} = 260\text{V}_{\text{RMS}}$, and $R_2 = 1\text{K}$, R_1 can be solved. See Equation 2:

$$R_1 = R_2 \times \left[\frac{V_{\text{IN}}}{V_{\text{OUT}}} - 1 \right] = 1000\Omega \times \left[\frac{260\text{V}}{176\text{mV}} - 1 \right] = 1.47\text{M}\Omega \quad \text{Eq. 2}$$

To give a 115% margin and to select common resistor values, $R_1 = 115\% \times 1.47\text{M}\Omega$ is selected and composed of four resistors: $4 \times 422\text{k}\Omega$.

The voltage sense resistor (R_2) must be referenced to the same potential as the current sensor and CS5490 power supply (located either on the Line or Neutral). By design, the CRD5490-Z is referenced to the Line side after the fuse. To switch the sensor reference, Line and Neutral of both the load and the source could be switched, and the fuse should be placed on the line externally.

2.2 Shunt Current Resistor

The CRD5490-Z implements current sensing using a low-resistance shunt. When a shunt is used, the current channel's signal amplitude will be set by the shunt resistor using Ohm's Law, $V = IR$. To keep power dissipation low, it is necessary to use a low-resistance shunt. The current channel of the CS5490 provides a high gain setting (50x) to enable the use of a low-valued shunt. The maximum input amplitude for the current channel is 35mV_{RMS} in the 50x gain range.

Applying Ohm's law, $V_{\text{OUT}} = I_{\text{SHUNT}} \times R_{\text{SHUNT}}$, use Equation 3 to solve for R_{SHUNT} :

$$R_{\text{SHUNT}} = \frac{V_{\text{OUT}}}{I_{\text{SHUNT}}} = \frac{35.36\text{mV}}{15\text{A}} = 2.35\text{m}\Omega \quad \text{Eq. 3}$$

To give an 85% margin, the shunt should be reduced by $R_{\text{SHUNT}} = 85\% \times 2.35\text{m}\Omega = 2\text{m}\Omega$. The power rating of the shunt should be at least twice the power dissipation on the shunt with the maximum continuous load current. With a maximum 15A load current, the CRD5490-Z uses a 2W shunt resistor.

2.3 Power Supply

The CRD5490-Z contains two separate power supply domains: isolated +5V USB supply and +3.3V non-isolated CS5490 power supply derived from the power line. The +3.3V non-isolated power supply circuit is designed to reduce the overall supply volume by creating a two-stage drop capacitor and buck supply.

By selecting an efficient buck design instead of a simple voltage regulator, the rectified supply voltage is raised, the transferred power is increased, and the drop capacitor value is reduced. Reducing the value substantially reduces the capacitor's size. If size is not a factor, the more expensive buck design could be replaced with a simple voltage regulator. Figure 3 and Figure 4 show the two options evaluated for the CRD5490-Z design. Contact Cirrus Logic sales for assistance with a cost-reduced, regulator-only design.

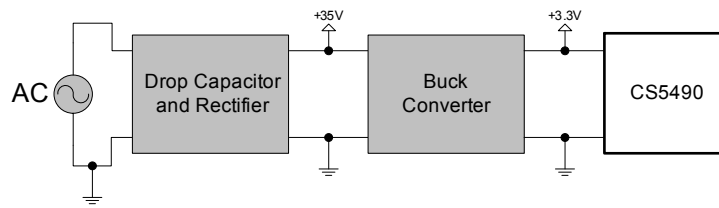

Figure 3. Power Supply Option 1

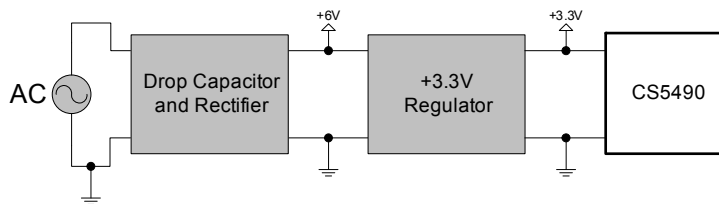

Figure 4. Power Supply Option 2

2.4 MCU Purpose

The CRD5490-Z is designed to minimize the requirements of the MCU. Virtually any low-cost MCU with non-volatile memory (NVM) can be used with the CS5490 device and software. The microchip MCU has the following purposes in the CRD5490-Z:

- Store and reload calibration coefficients
- Perform USB to UART transactions that mimic a serial COM port

USB transactions are sent from the PC to the MCU. The MCU reads the first byte (character) and determines whether it should transmit the remaining bytes to the CS5490 as a Write/Read/DSP command or store or recall as calibration coefficients into NVM. All responses from the CS5490 are directly translated back to the PC via the MCU.

MCU UART communication transactions can be viewed at the bottom of the GUI. Characters sent or received are displayed in hexadecimal format. Refer to Figure 26.

3. SOFTWARE OVERVIEW

The evaluation board comes with software and a USB cable to link the evaluation board to the PC. The evaluation software was developed with Microsoft® Visual Studio® and was designed to run with Windows XP™ and Windows 7™. The following procedure is based on Windows XP.

3.1 Installation Procedure

Follow the steps below to install the GUI and the CDC driver software:

1. Access the following web site: <http://www.cirrus.com/en/support>.
2. Click the **Energy Measurement** link.
3. Click the **CRD5490** link. The Software License web page is displayed.
4. To agree with the terms and conditions, click the **Agree** button. The File Download window is displayed.
5. Click the **Save** button. The Save As window is displayed.
6. Select a location to store the compressed folder.
7. Click the **Save** button. The Download complete window is displayed.
8. Click the **Open Folder** button. The location where the compressed folder is stored is displayed.
9. Right-click on the compressed folder, and click **Extract All**.
10. Select a location to extract the files.
11. Navigate to the location where the extracted files are stored and double-click on the **setup.exe** file.

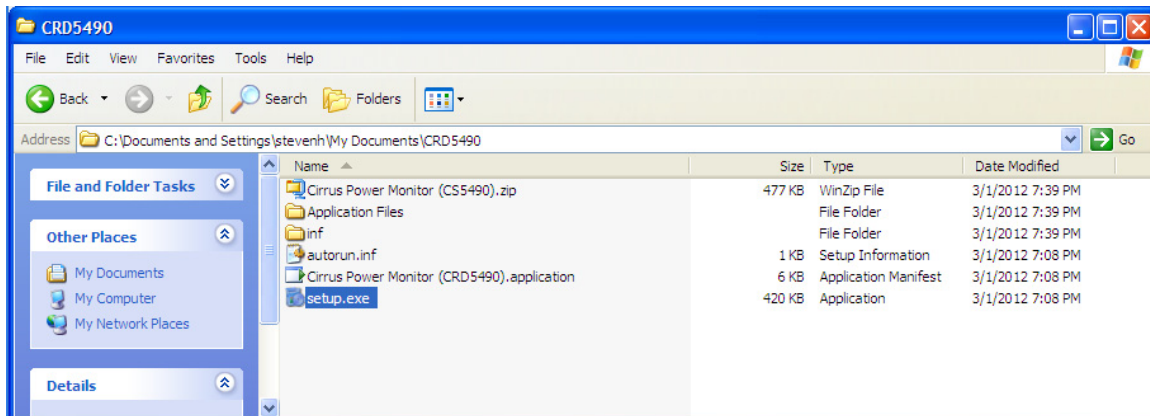

Figure 5. Location of the Unzipped Files

The application will verify system requirements. The Application Install - Security Warning window is displayed.

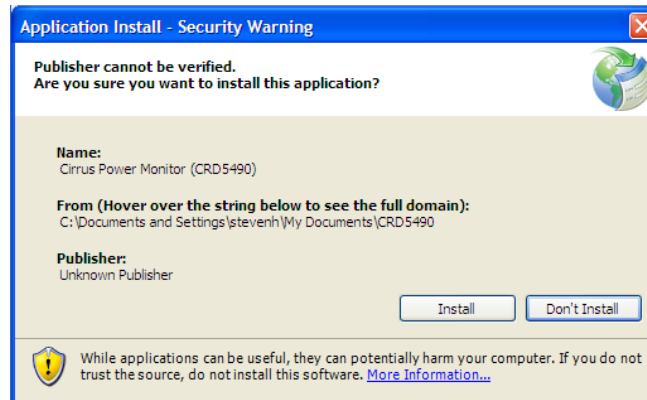

Figure 6. Application Install - Security Warning Window

12. Click the **Install** button.
13. Follow the instructions of the Microsoft.Net Framework installation.

The Microsoft.Net Framework may need to be installed on the system. Internet access may be required to install the Framework or language packs. The download will start automatically. If installation stops after Framework is installed, select setup.exe from step 11.

The installation program will automatically load the application after installation. If the CDC driver is already installed and the CRD5490-Z is connected (AC power and USB cable), then the CRD5490-Z will be recognized and ready.

If the CDC driver is not installed, connect the USB and AC power source, then install the serial CDC Driver when Windows recognizes the device. Refer to Appendix 2: CDC Driver Installation on page 26 for more details.

14. If necessary, execute the GUI using the next section, 3.1.1 Executing the GUI.

3.1.1 Executing the GUI

1. From the Start menu, click **All Programs**.
2. Click **Cirrus Logic**.
3. Click **Cirrus Power Monitor (CS5490)**. The GUI is launched.

3.2 Using the Software

Before launching the software, ensure that all of the cables connected to the CRD5490-Z are installed (as described in the Hardware Overview section on page 4) and connect the board to an open USB port on the PC using the provided cable. Once the board is powered through the AC line and USB, the software program can be launched.

Danger
High Voltage

WARNING

High Voltage Hazard

Danger
High Voltage

When the CRD5490-Z is connected to AC lines, high voltage is present inside the box. Do not remove the protective cover from the CRD5490-Z when power is connected.

The evaluation board connects directly to the AC power line and presents a serious risk of electric shock and can cause serious injury or death. Extreme caution needs to be exercised while handling this box. Make sure that the power source is off before wiring any connection. Make sure that all connectors are well connected before the power source is turned on. Make sure all AC power line wiring is secured to the box and away from contact before the power source is on.

Refer to additional warnings at the beginning of this document.

3.3 Start-up Window

When the software is launched, the Cirrus Logic - Power Monitor window is displayed. This window contains information about the software's title, version, and device revision number. See Figure 7.

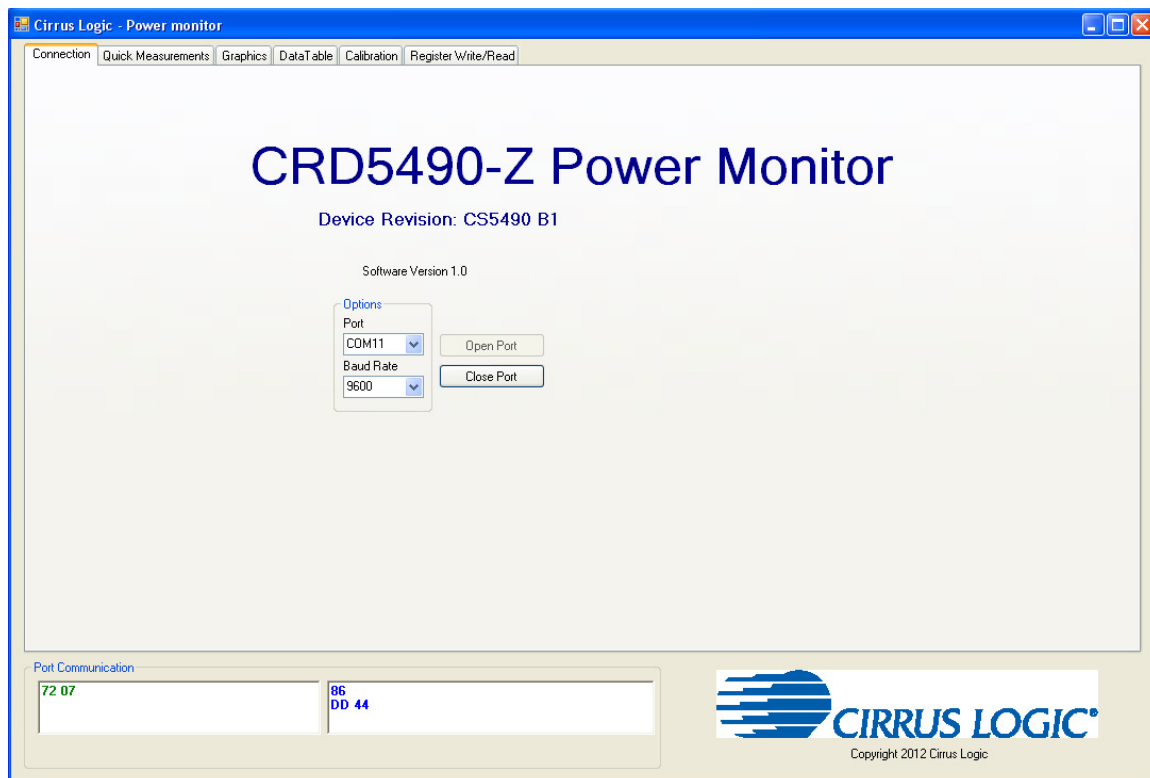

Figure 7. Cirrus Logic - Power monitor Window

The tabs in this window provide access to GUI functions. The following subsections describe the tabs in this window.

3.3.1 Connection Tab

The Connection tab displays the USB communication with CRD5490-Z board. At startup, the GUI attempts to establish a connection to the CRD5490-Z to the PC through the last USB device connected.

Once the USB communication has been established, the CS5490 serial port will report the Device Revision on the Connection tab. If the software is unable to establish a communication link with the CRD5490-Z board, a message is displayed indicating that the initial communication has failed. This message is displayed in Figure 8.

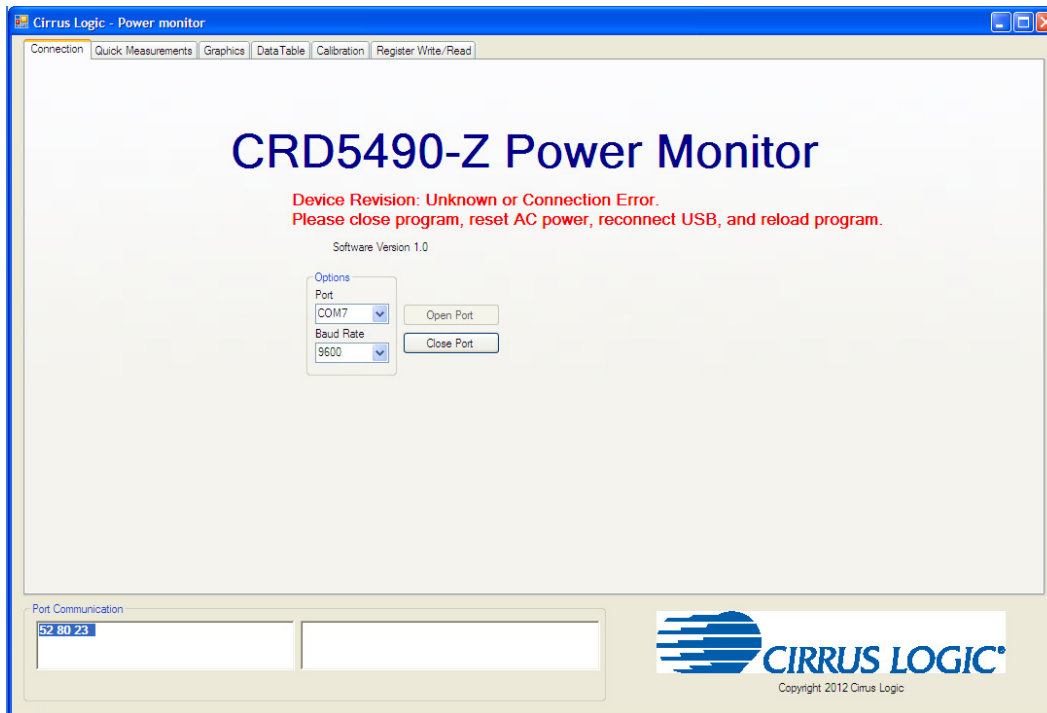

Figure 8. Connection Tab with Communication Error Displayed

3.3.1.1 Common Causes of Communication Error

- No AC power
- USB cable is not connected
- USB cable to the CRD was not the last device connected before loading the GUI
- Windows is not given time to recognize the device and assign a serial port
- The wrong serial port is assigned because the GUI was loaded before the above items were met

3.3.1.2 Fixing Communication Problems

1. Close the GUI.
2. Remove the power to the CRD5490-Z by turning off the AC source.
3. Remove the power to the MCU by removing the USB cable from the PC.
4. Check that the AC power connections are secure.
5. Connect the USB cable to the PC.
6. Wait for Windows to detect the CDC Device. Verify the port by opening the Device Manager and reviewing the port assignments (run "devmgmt.msc" at a command prompt or Windows 7 search).
7. Apply AC power and wait a second.
8. Reload the GUI.

3.3.2 Quick Measurements Tab

The Quick Measurements tab displays reported power data from the CS5490 device in real time as continuous conversions are performed. Refer to the CS5490 data sheet, entitled *Two Channel Energy Measurement IC*, for more information about continuous conversion.

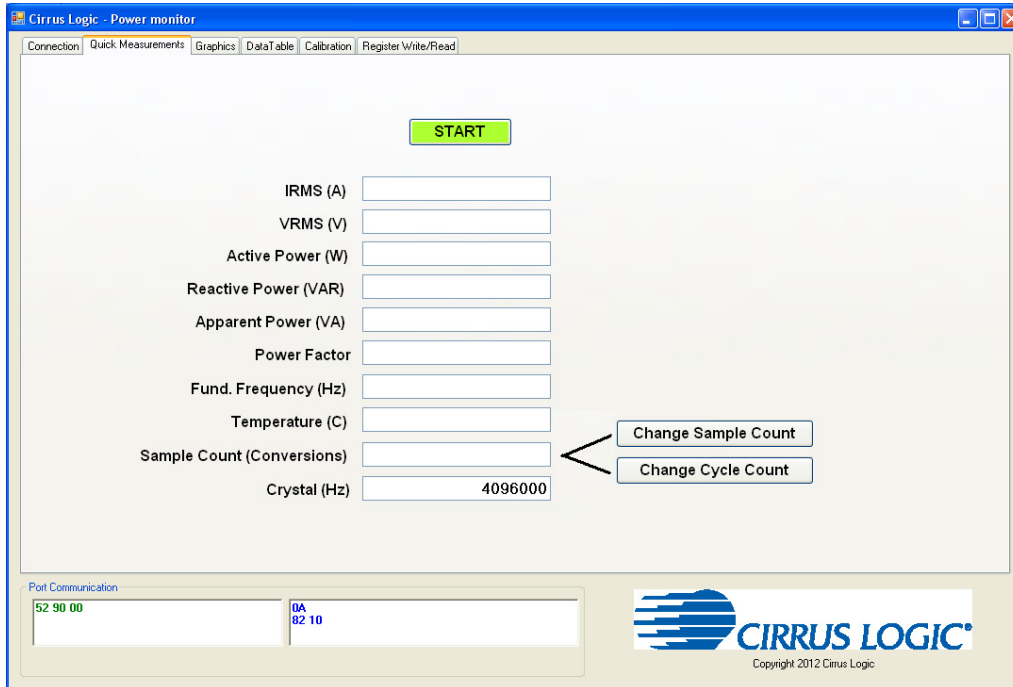

Figure 9. Quick Measurements Tab - Idle

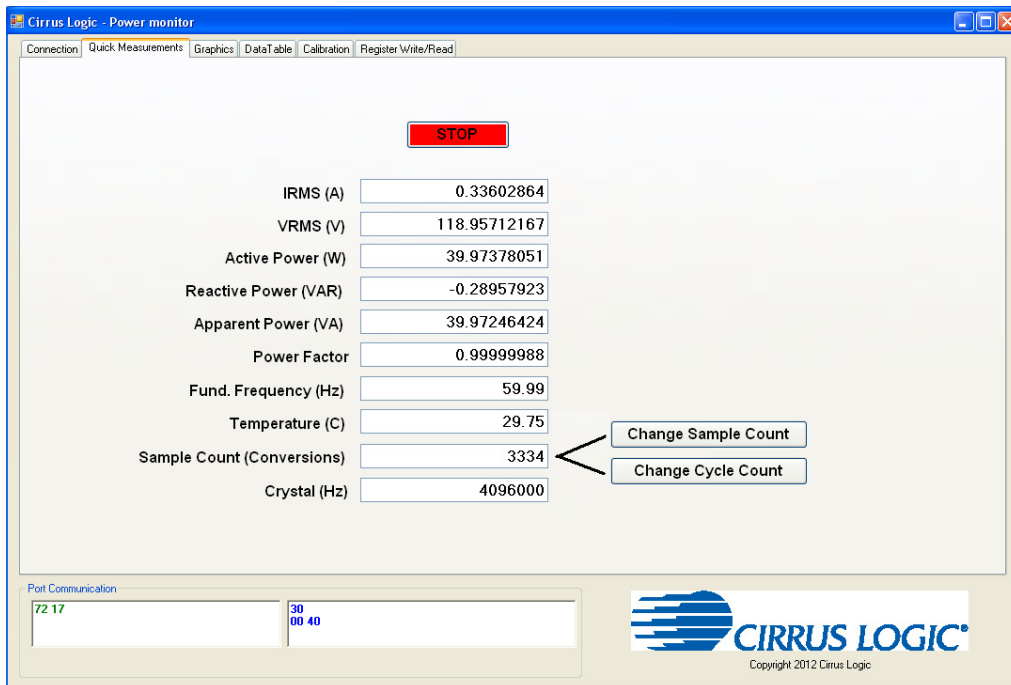

Figure 10. Quick Measurements Tab - Continuous Convert

The Connection, Graphics, and Quick Measurements tabs may be viewed with the conversions running, but the continuous conversions should be stopped before moving to the Data Table, Calibration, or Register Write/Read tabs.

3.3.2.1 *START Button*

The START button starts continuous conversions execution until the STOP button is clicked. The power measurements are updated with present values in the CS5490 data registers after each conversion. The refresh rate is configured by the *SampleCount* or *CycleCount* register.

3.3.2.2 *Change Sample Count Button*

Whether this option is available depends on the CS5490 device revision and configuration. The default low-rate refresh rate for data is 1 second, or 4000 samples. Click the Change Sample Count button to change the *SampleCount* register. Enter a larger number of samples to slow the low-rate refresh rate. It is not recommended to reduce the *SampleCount* below 2000 samples.

3.3.2.3 *Change Cycle Count Button*

Whether this option is available depends on the CS5490 device revision and configuration. The default low-rate refresh rate for data is 1 second, or 100 line cycles at 50Hz. The CS5490 counts the samples in a half-line cycle and updates the *SampleCount* register automatically based on the *CycleCount* entered. Click the Change Cycle Count button to change the *CycleCount* register. Enter a larger number of cycles to slow the low-rate refresh rate. It is not recommended to reduce the *CycleCount* 50 cycles.

3.3.3 *Graphics Tab*

The Graphics tab displays the power data of the CS5490 versus low-rate samples in individual charts. To view data in real time, click the START button on the Quick Measurements tab, which initiates conversions, and then click the Graphics tab to bring it forward.

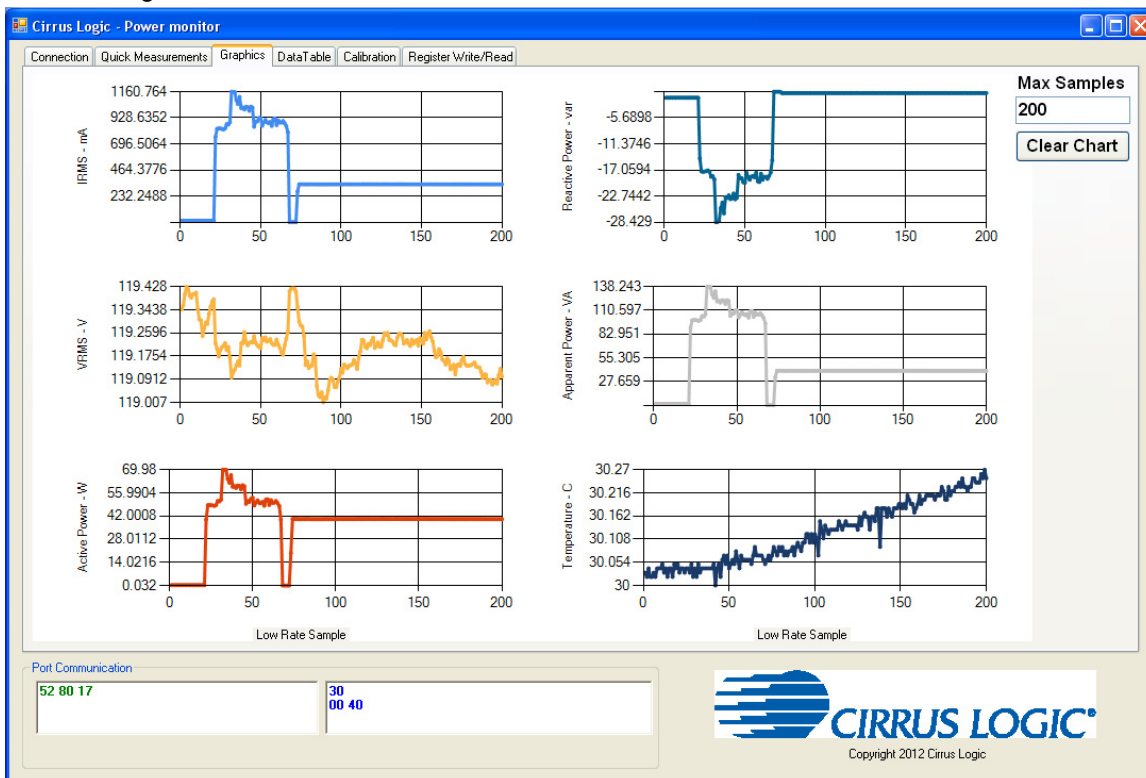

Figure 11. Graphics Tab

The charts' scales will automatically adjust for the data captured. To zoom in on a portion of a chart, click in the chart and drag a box over the portion to be enlarged. Scroll bars are displayed in the magnified chart. See Figure 12.

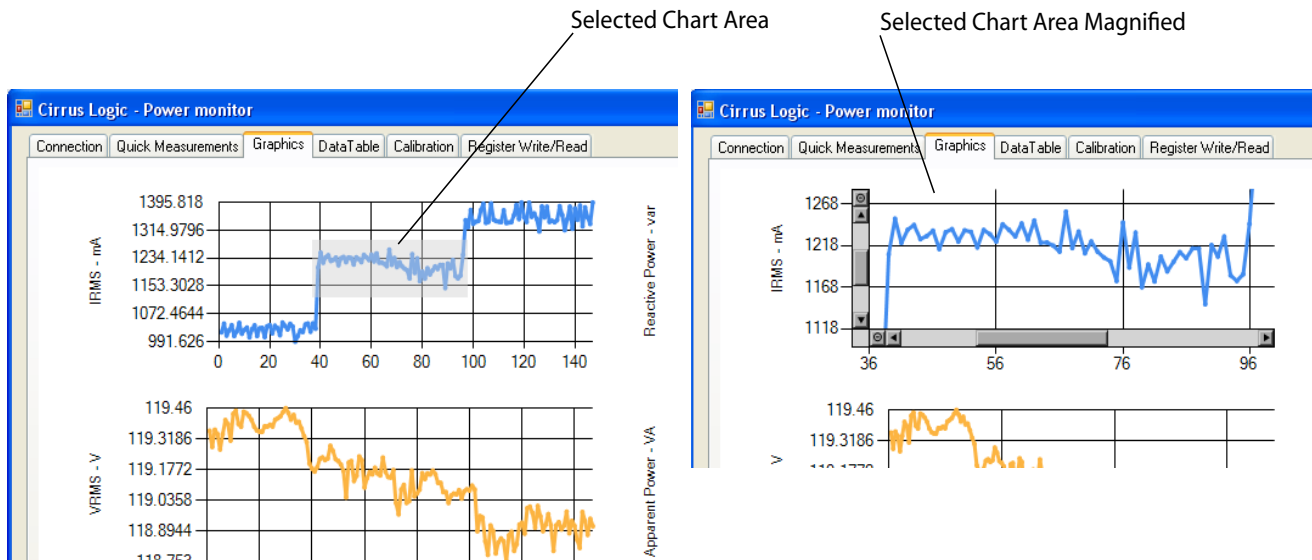

Figure 12. Graphics Tab with Chart Zoom Example

It is recommended to stop conversions before clicking on charts. Transactions are stopped when selecting a chart, and samples may be missed.

3.3.3.1 Max Samples Field

The charts will display a maximum number of samples based on the value entered in the Max Samples field. It is recommended to stop conversions before entering new values into the Max Samples field. Changes take effect immediately.

The Max Samples field should not be made too large. Otherwise, the window will update slowly and samples will be missed. When using the default sample count, generally the Maximum Samples field should be less than 500 samples and may vary depending on the PC hardware. To view a larger number of samples without missing samples, click the Quick Measurements tab to bring it forward, wait for data to be collected, stop conversions, and then click on the Graphics tab to bring it forward.

3.3.3.2 Clear Chart Button

The Clear Chart button clears all the charts.

3.3.4 Data Table Tab

The Data Table tab displays the CS5490 power information in a table. Stop conversions before viewing the Data Table tab.

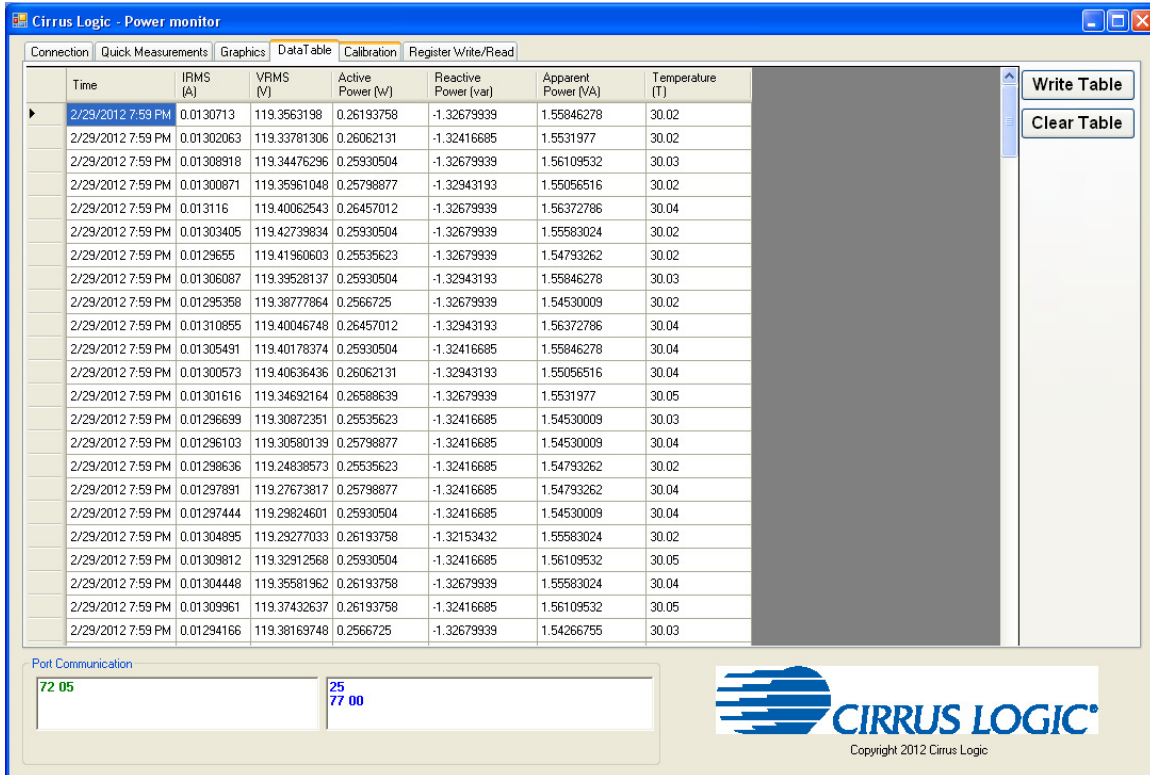

Figure 13. Data Table Tab

3.3.4.1 Write Table Button

The Write Table button writes the full data table to a comma-delimited file (*.csv) using Windows' standard file window. Select the directory location and filename in the Save As window.

3.3.4.2 Clear Table Button

The Clear Table button clears the table.

3.3.5 Calibration Tab

The Calibration tab is used to write and display to the CS5490 offset and gain calibration registers. The built-in calibration sequences of the CS5490 that are used to set the calibration register can be initiated from the Calibration tab. AC offset and gain calibration can be performed on the voltage channel, the current channel, or both simultaneously. Refer to the CS5490 data sheet, entitled *Two Channel Energy Measurement IC*, and Application Note AN366, entitled *CS5480/84/90 Energy Measurement IC Calibration*, for more details on calibration. The Calibration tab is illustrated in Figure 14.

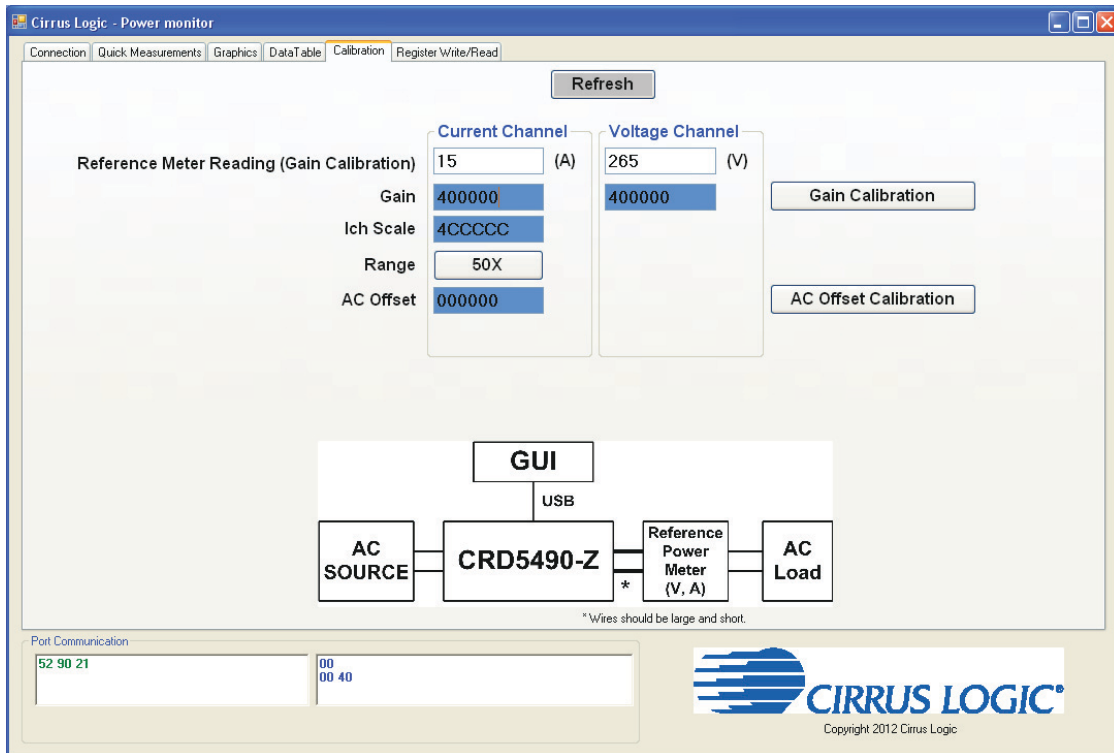

Figure 14. Calibration Tab

To access the Calibration tab, conversion must be stopped. Otherwise, the Quick Measurements tab will be displayed with the error message shown in Figure 15.

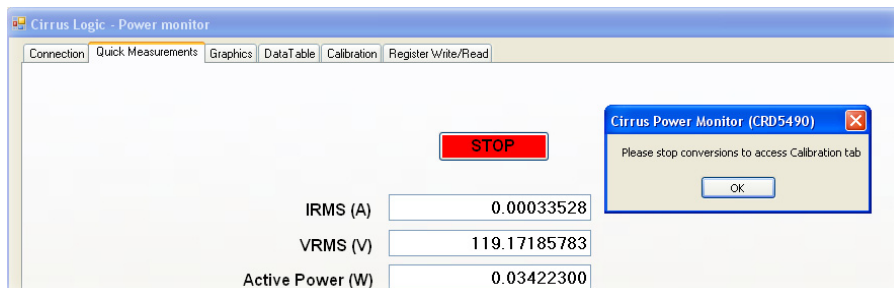

Figure 15. Quick Measurements Tab with Error Message Displayed (Partially Illustrated)

The Refresh button updates the contents of the screen by reading all the register values from the CS5490. It is recommended to click the Refresh button when entering the Calibration tab or after modifying any registers to reflect the current status of the CS5490.

3.3.5.1 AC Offset / Gain Register

In the AC Offset and Gain fields, the AC offset and gain registers for all channels are displayed in hexadecimal format. These registers can be modified directly by typing values in the fields and then pressing Enter on the keyboard. The AC offset register only affects the current channel's I_{RMS} register values.

3.3.5.2 Performing Calibrations

To ensure accurate results, Gain calibration should be performed before AC offset calibration. The gain calibration can be performed on both the voltage and current channels of the CS5490. The AC offset calibration can be performed only on the current channel. In the CS5490, the initial values in the calibration registers affect the results of the calibration. The register values are shown in blue in Figure 14. Before calibration, the gain and offset registers should be configured in their default state 0x 40 0000 (gain = 1) for gain registers and 0x 00 0000 (clear = 0) for offset registers.

Gain Calibration

For gain calibration, the CRD5490-Z software configures the gain registers prior to setting up calibration based on the reference meter readings. The CRD5490-Z software uses the non-full scale gain calibration techniques and formulas in Appendix 3: Non-Full Scale Gain Calibration (see page 33) to set up the CS5490 voltage and current channel gain registers before calibration. The AC offset register values are not modified by the software, and the current configuration are used. The default AC offset register value should be 0x 00 0000.

1. Attach an AC reference meter as configured in Figure 16. It is important to use short and large gauge wires to attach the reference power meter to reduce error.

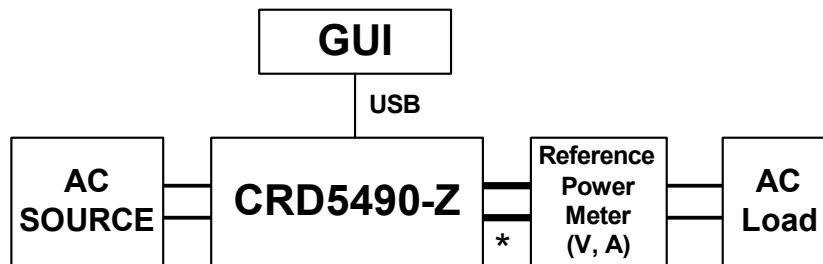

Figure 16. Gain Calibration Configuration

2. Attach and turn on an AC source.
3. Attach and turn on AC load. For this example, a 200W light bulb is used, but it is recommended to use a load that is at a minimum of $\frac{1}{2}$ of the full-scale load current.

- Confirm that the initial conditions are configured as shown in Figure 17:

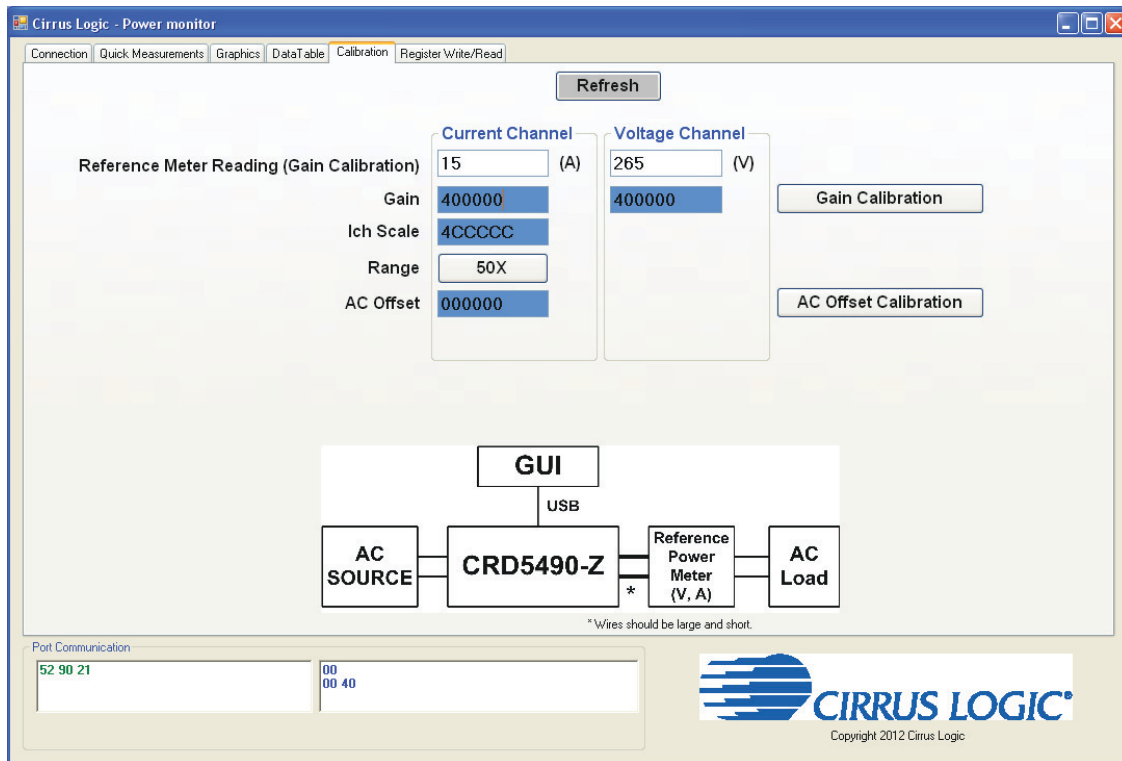

Figure 17. Calibration Tab with Initial Calibration Configuration

- Click the **Quick Measurements** tab to bring it forward, and click the **START** button.
- Wait approximately 5 to 10 seconds for the readings to update.
- Click the **STOP** button.

8. **Record** the reference meter measurements after the setup has settled and before calibration is executed. See Figure 18.

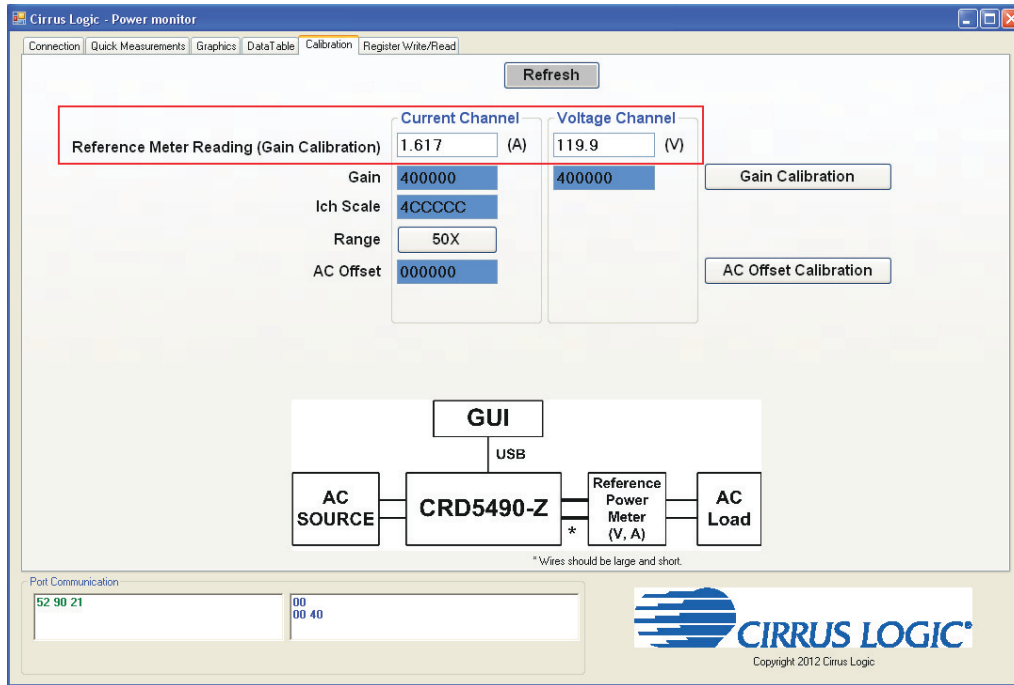

Figure 18. Calibration Tab with Reference Meter Reading

9. Click the **Gain Calibration** button.
10. A confirmation message is displayed, as shown in Figure 19.

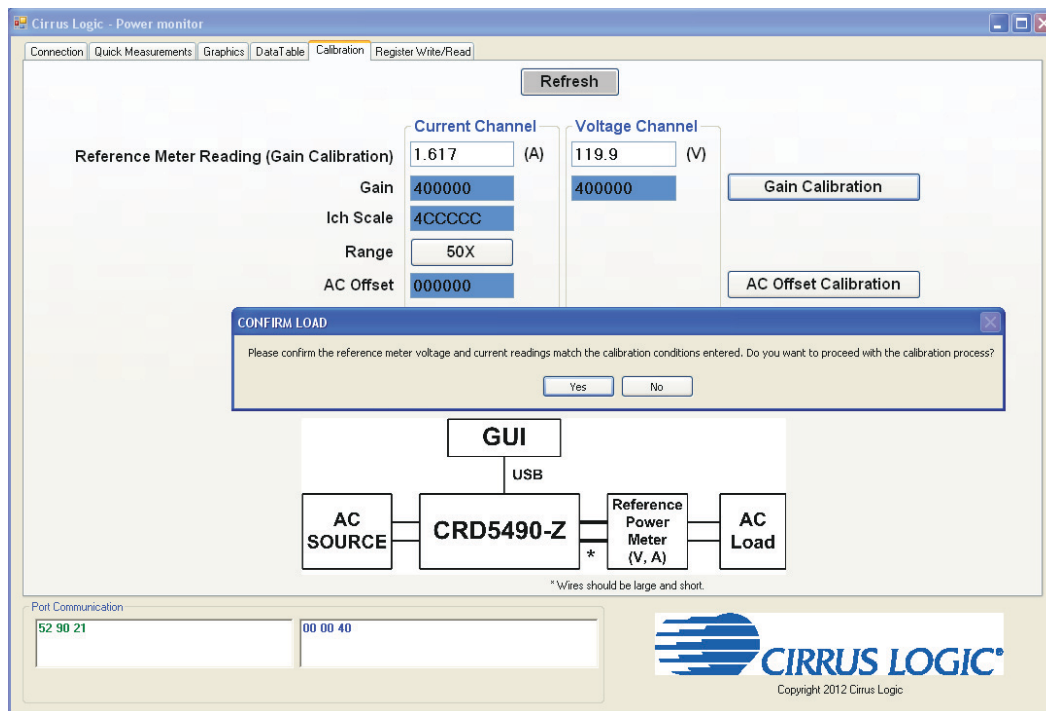

Figure 19. Calibration Tab with Confirmation Message

If the calibration conditions (voltage and current) match the reference meter readings, click the **Yes** button.

11. The gain register values automatically update when the calibration is complete.

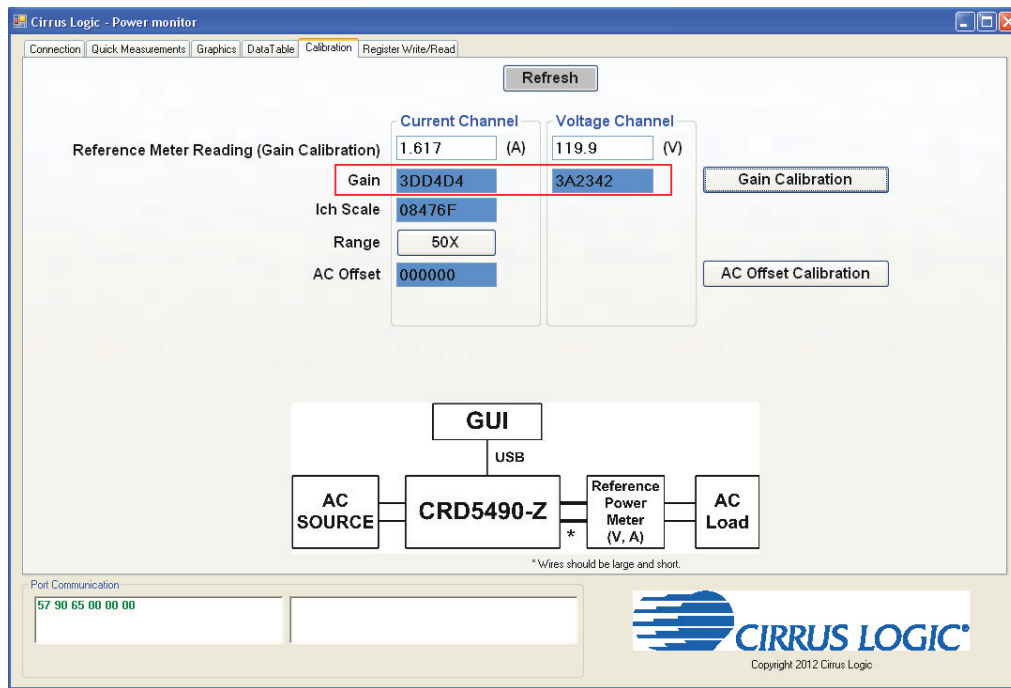

Figure 20. Calibration Tab with Gain Register Updated After Gain Calibration

12. To confirm results click the **Quick Measurements** tab to bring it forward, and click the **START** button.

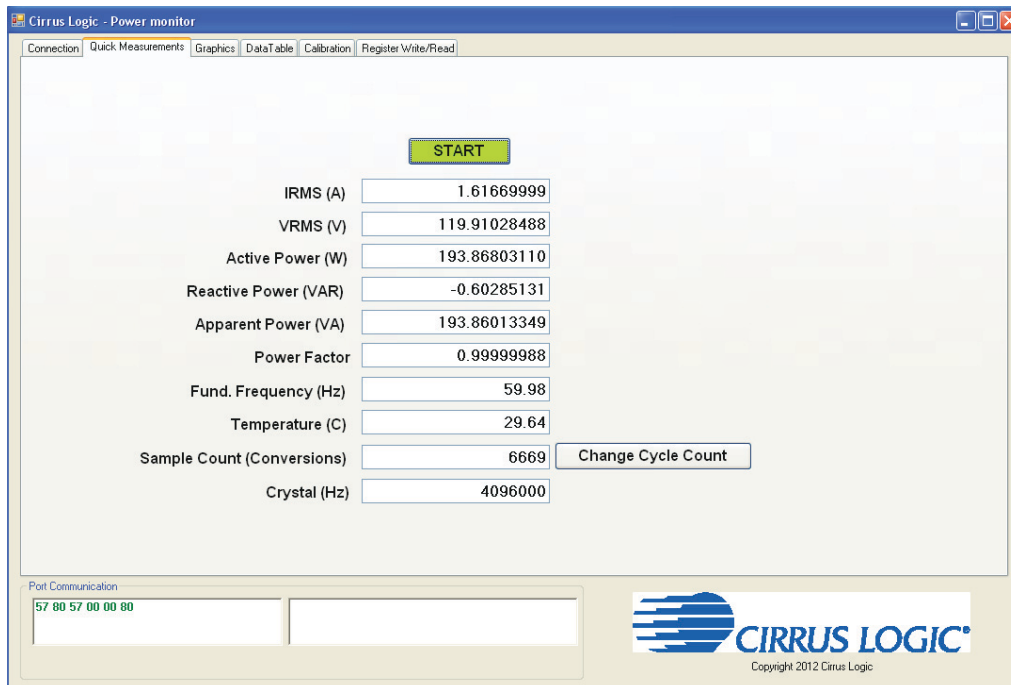

Figure 21. Quick Measurements Tab Showing Results that Should Match the Reference Meter

13. Results should match the reference meter readings.

AC Offset Calibrations

For AC offset calibration, the CRD5490-Z software clears the offset register before calibration begins. The gain register values are not modified by the software, and the current configuration is used from the prior gain calibration. AC calibration only affects the current channel's I_{RMS} value.

1. Continue from step 13 in the Gain Calibration section on page 16 and keep the AC source on.
2. Remove the AC load.
3. Open the **Quick Measurements** tab and click the **START** button.
4. Wait approximately 5 to 10 seconds for readings to update.
5. Click the **STOP** button.
6. Confirm that the current is as expected during a no-load condition. Inspect the pre-calibrated I_{RMS} closely.

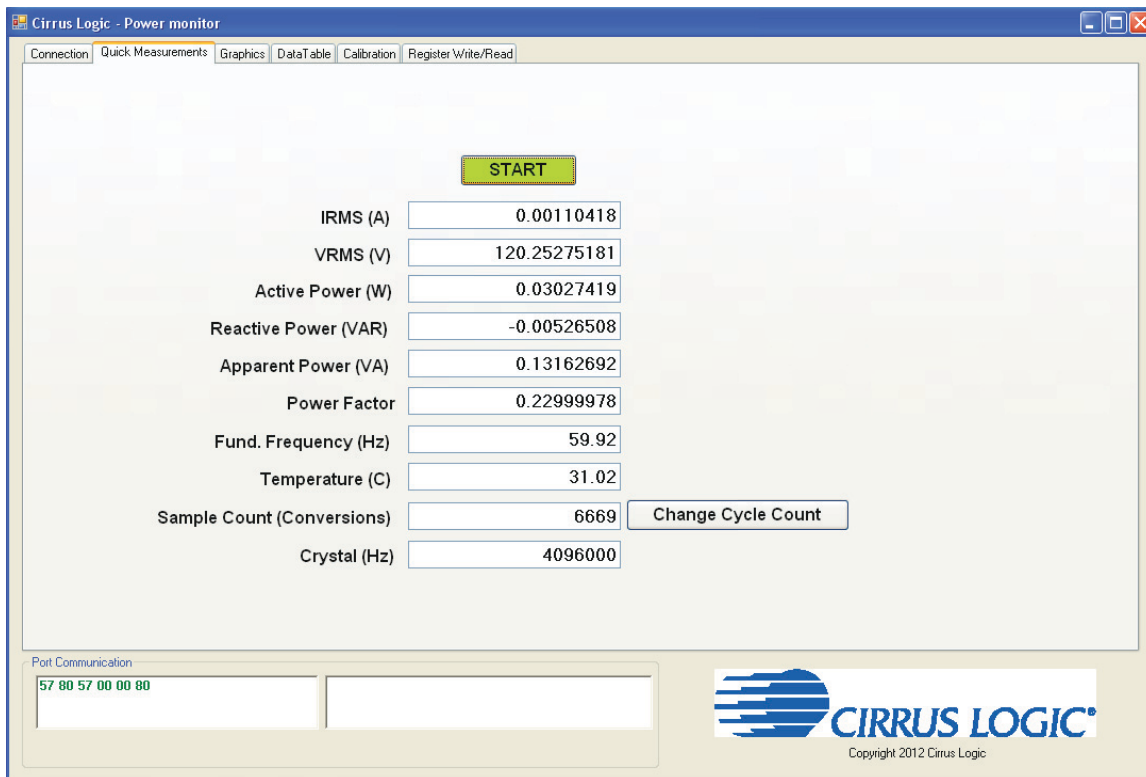

Figure 22. Quick Measurements Tab - Note I_{RMS} before AC Offset Calibration

7. Click the **Calibration** tab to bring it forward, and click the **AC Offset Calibration** button.

- Confirm the load has been removed or turned off, and then click **Yes** from the CONFIRM LOAD window shown in Figure 23.

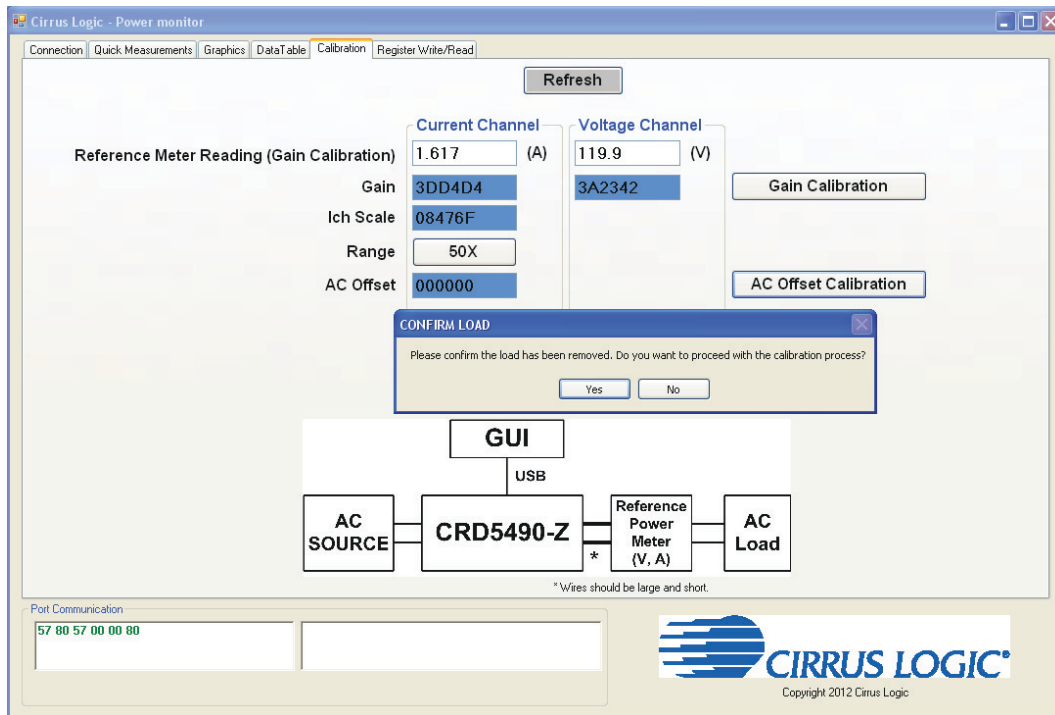

Figure 23. Calibration Tab with CONFIRM LOAD Window

- The offset register value automatically updates when the calibration is completed (approximately 5 seconds). The AC Offset register value should change.

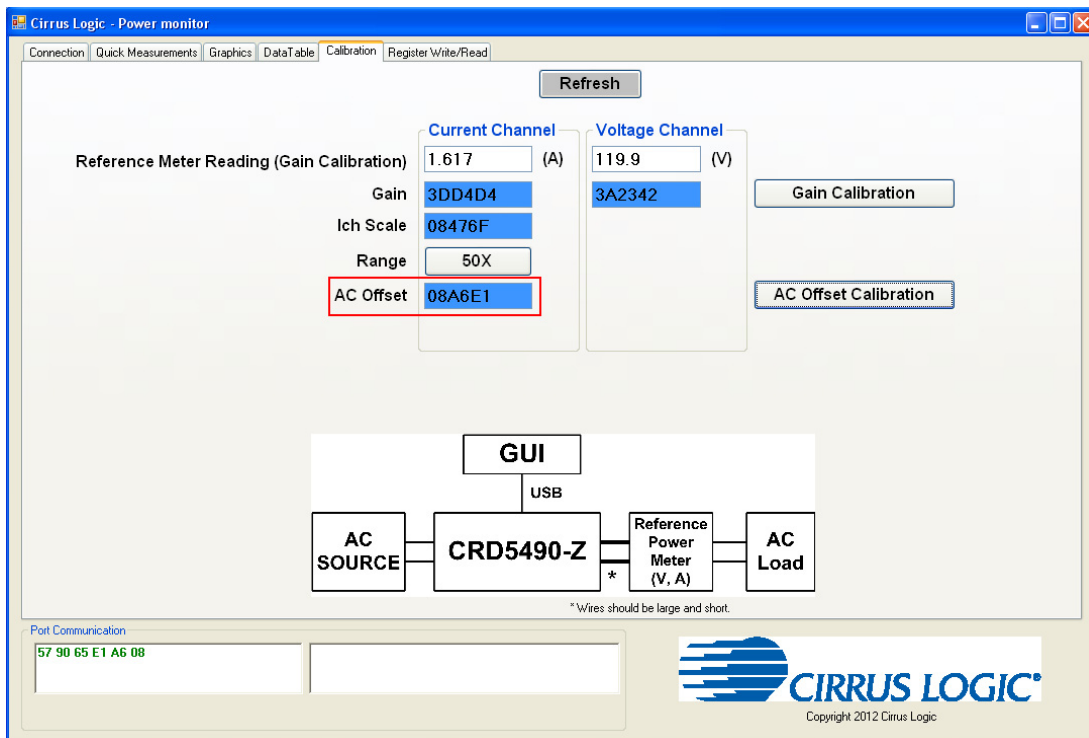

Figure 24. AC Offset Register Updated After AC Offset Calibration

10. To confirm results, click the **Quick Measurements** tab to bring it forward, and click the **START** button.

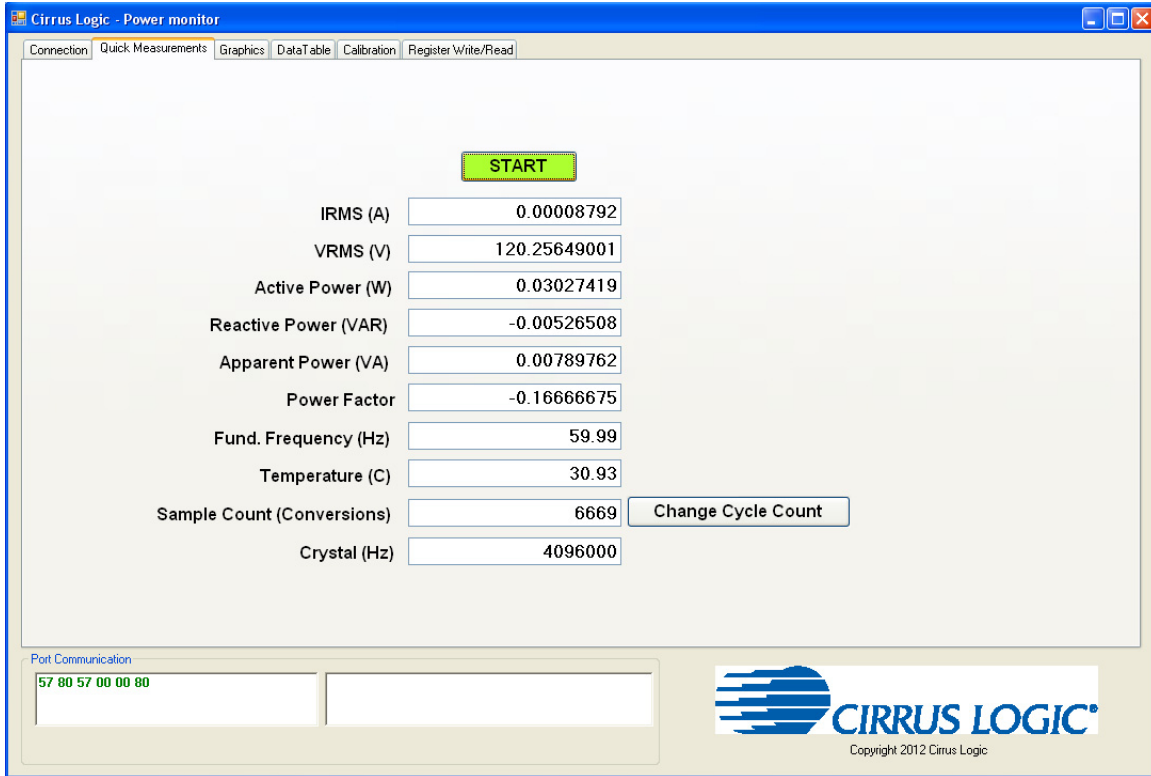

Figure 25. Confirm I_{RMS} Reduced After AC Offset Calibration

Results should show a reduction in the I_{RMS} value without the load.

3.3.6 Register Write/Read Tab

The Register Write/Read tab allows access to the CS5490 registers directly. See Figure 26.

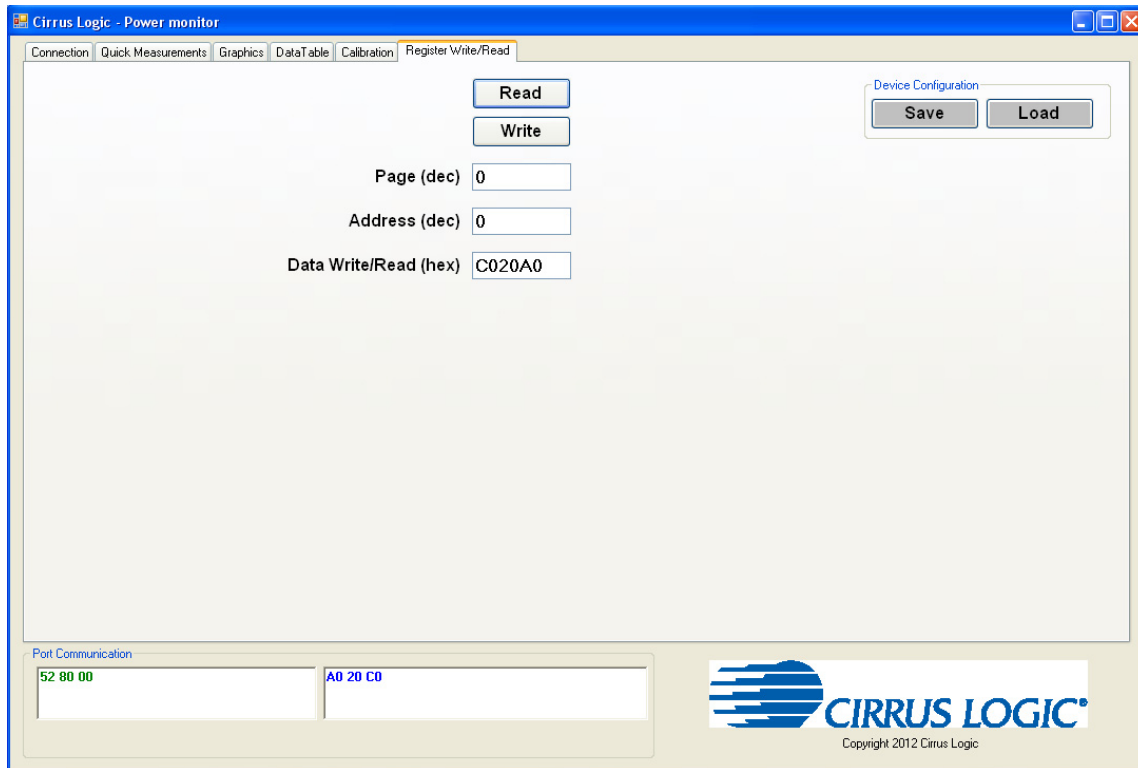

Figure 26. Register Write/Read Tab - Read

There are two types of transactions: Write and Read. The CS5490 memory is organized by pages. In order to properly write a register, it is necessary to set the Page, Address, and Data field and then click the Write button. To read a register it is necessary to set the Page and Address and then click the Read button. Figure 26 shows the read operation. The serial port traffic can be seen in the bottom left corner. The register result is displayed in the Data Write/Read (hex) field. Refer to the CS5490 data sheet, entitled *Two Channel Energy Measurement IC*, for more details on registers and commands. Note that the write data in the Port Communication field has an extra leading command byte - "52" in the example. This is a read command for the MCU. Read data does not contain an extra byte.

Common CS5490 registers can be written to a file using the SAVE button in the Device Configuration panel. The LOAD button is used to recall the common CS5490 registers that were previously saved. It is recommended to configure the device using the Write button, start conversions from the Quick Measurements tab, stop conversions, and then save the current configuration to a file.

4. REVISION HISTORY

Revision	Date	Changes
RD1	APR 2012	Initial Release.

APPENDIX 1: CRD5490 GUI REMOVAL

Follow the steps below to remove the CS5490 GUI software:

1. From the **Start** menu, click **Control Panel**. The Control Panel window is displayed.

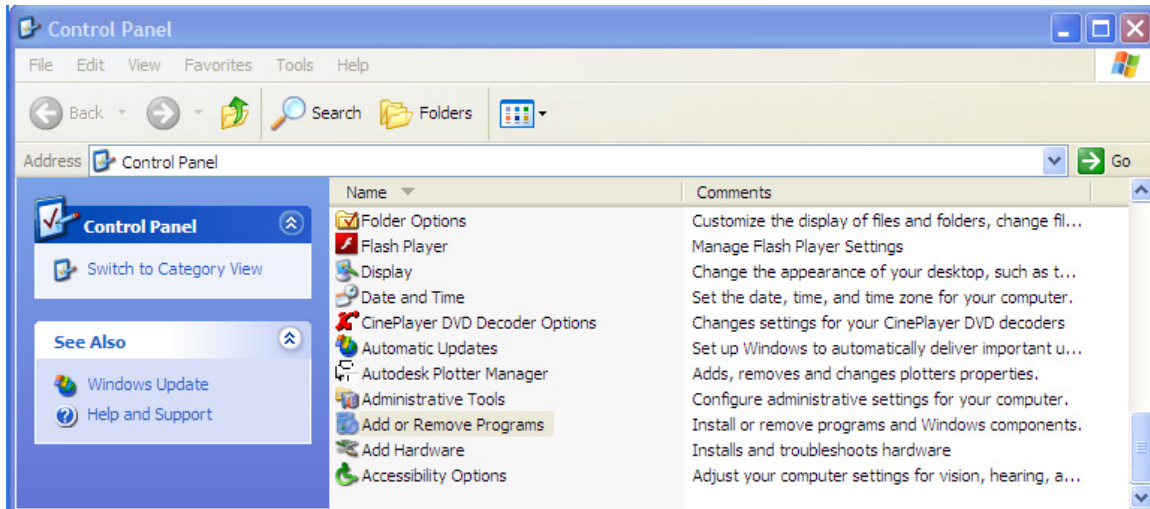

Figure 27. Control Panel Window

2. Click **Add or Remove Programs**. The Add or Remove Programs window is displayed.
3. Highlight to select the **Cirrus Power Monitor (CRD5490)** item, as shown in Figure 28.

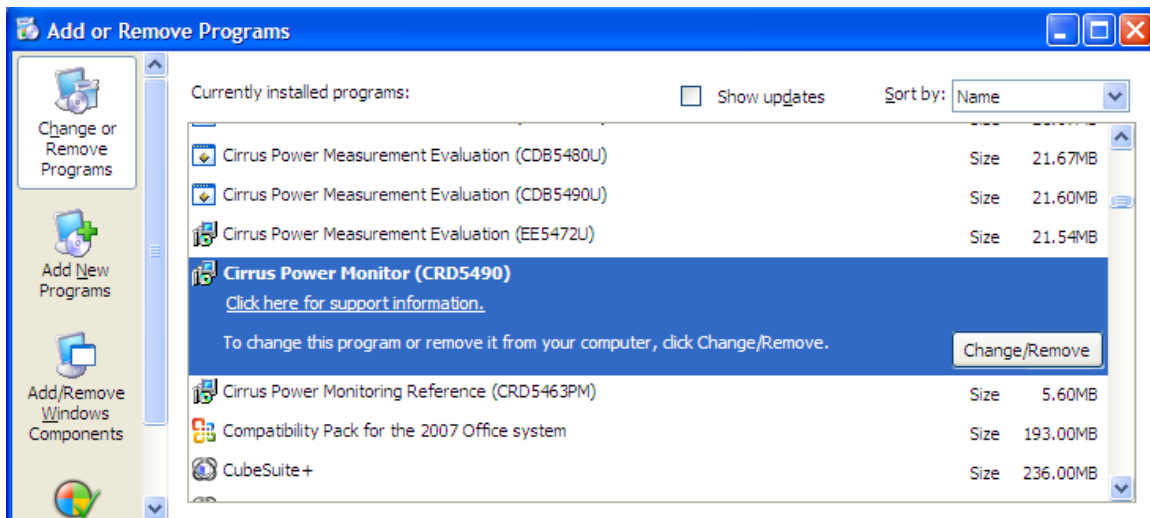

Figure 28. Add or Remove Programs with Cirrus Power Monitor (CRD5490) Displayed

4. Click the **Change/Remove** button, and follow the instructions. The CS5490 GUI is removed.

APPENDIX 2: CDC DRIVER INSTALLATION

This Appendix includes the procedures for installing the CDC driver for both Windows 7 and Windows XP.

2.1 Installing the CDC Driver Using Windows 7

Follow the instructions below to install the CDC driver on the Windows 7 operating system.

1. Connect the provided USB cable from the CRD5490-Z to the PC. Windows will recognize the device.
2. From the Start menu, select **Devices and Printers**.
3. Right-click the **CDC RS-232 Emulation Demo** icon.

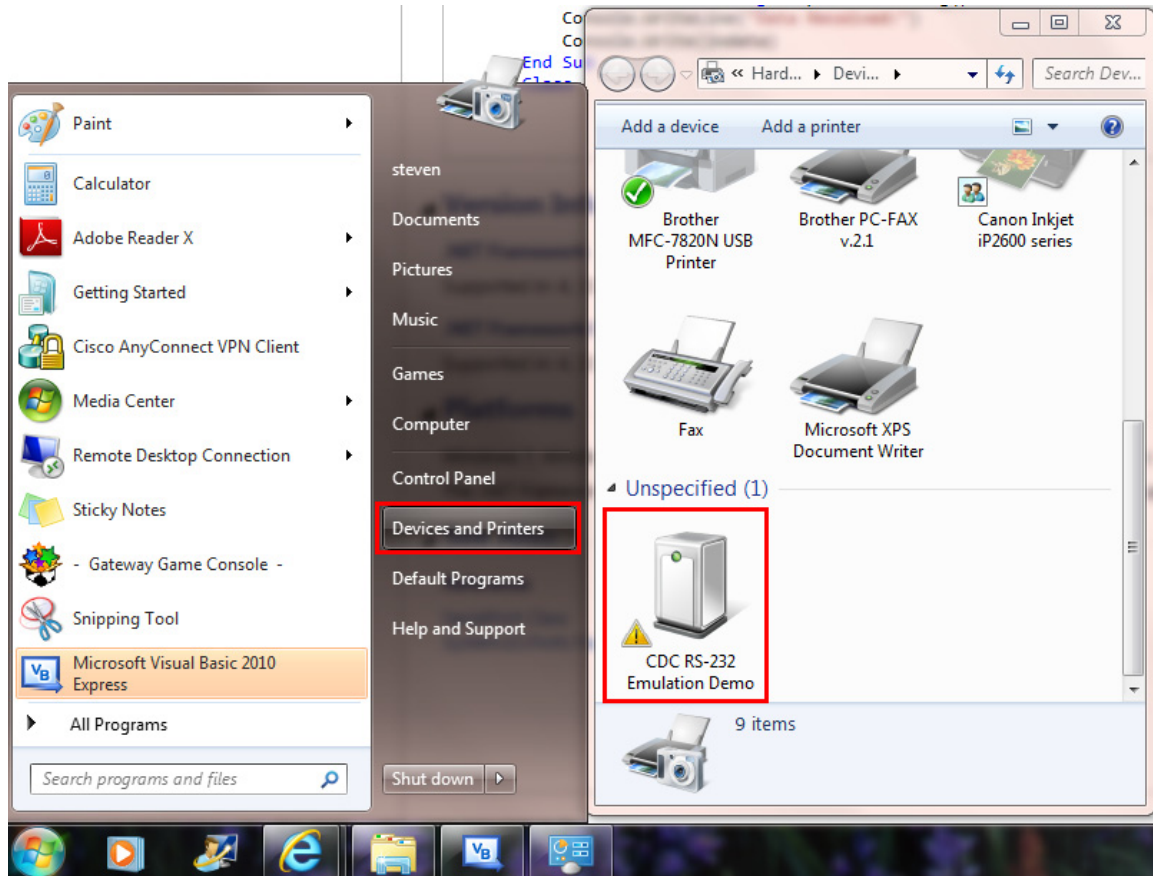

Figure 29. Start Menu with Drivers and Printers Selected

The CDC RS-232 Emulation Demo Properties Window is displayed.

4. Click the **Hardware** tab to bring it forward.

- Click the **Properties** button

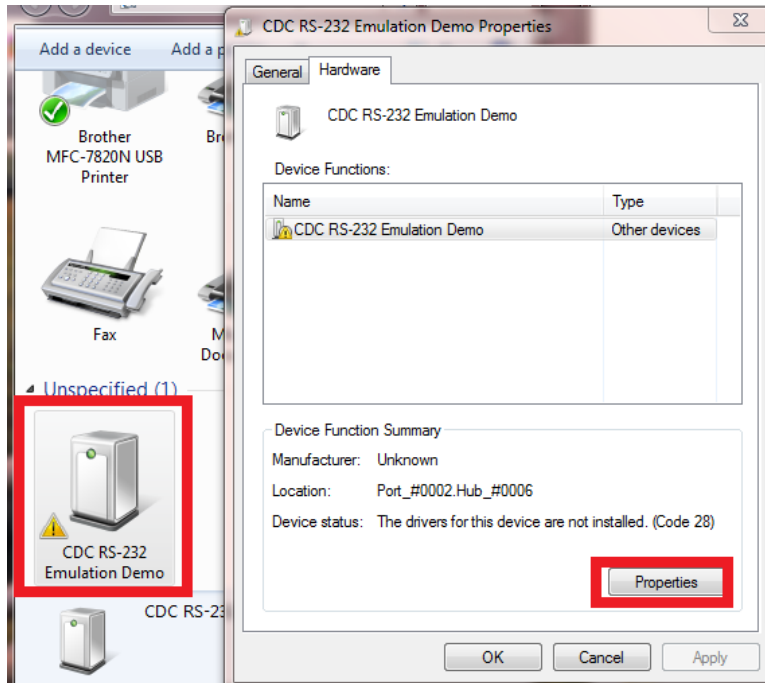

Figure 30. CDC RS-232 Emulation Demo Properties Window

- Click the **General** tab to bring it forward, and click the **Change Settings** button.

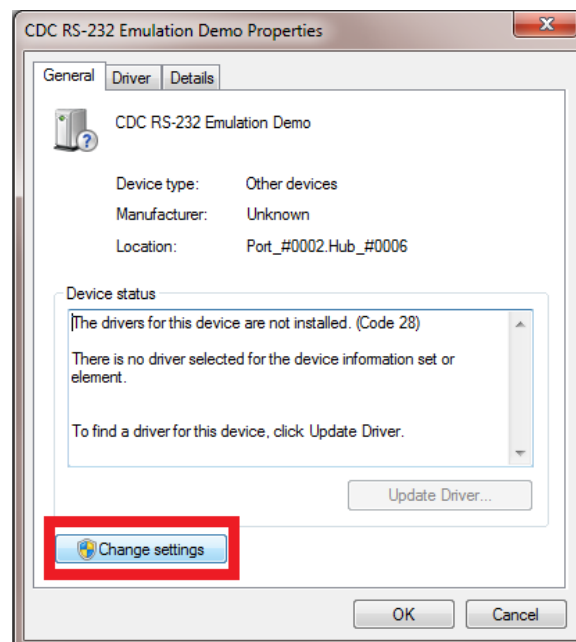

Figure 31. General Tab with the Change Settings Button Highlighted

- Click the **Update Driver** button.

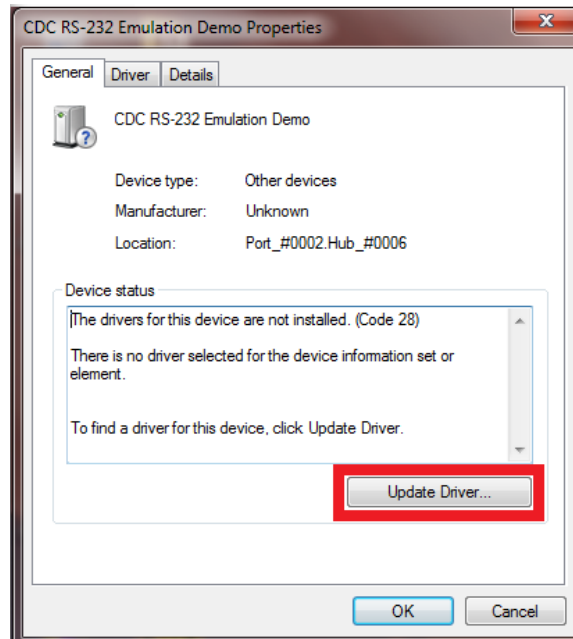

Figure 32. General Tab with the Update Driver Button Active

The Update Driver Software CDC RS-232 Emulation Demo panel is displayed.

- Click **Browse my computer for driver software**.

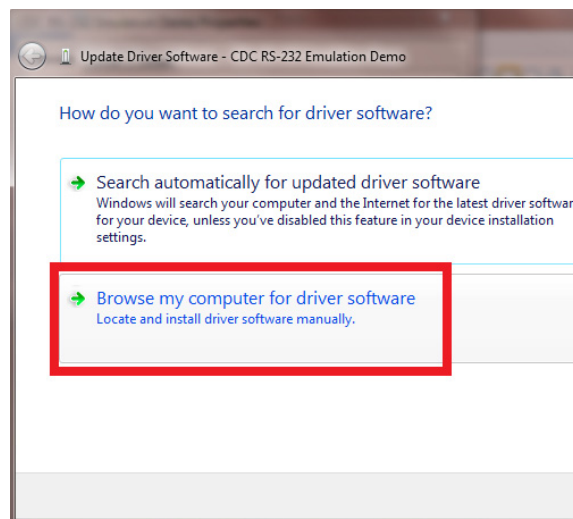

Figure 33. Update Driver Software Panel Options (Partially Illustrated)

- Select the extracted file location, then select the. \inf\win2K_winxp\ directory.

10. Follow the installation instructions. If warnings are displayed, select to continue anyway.

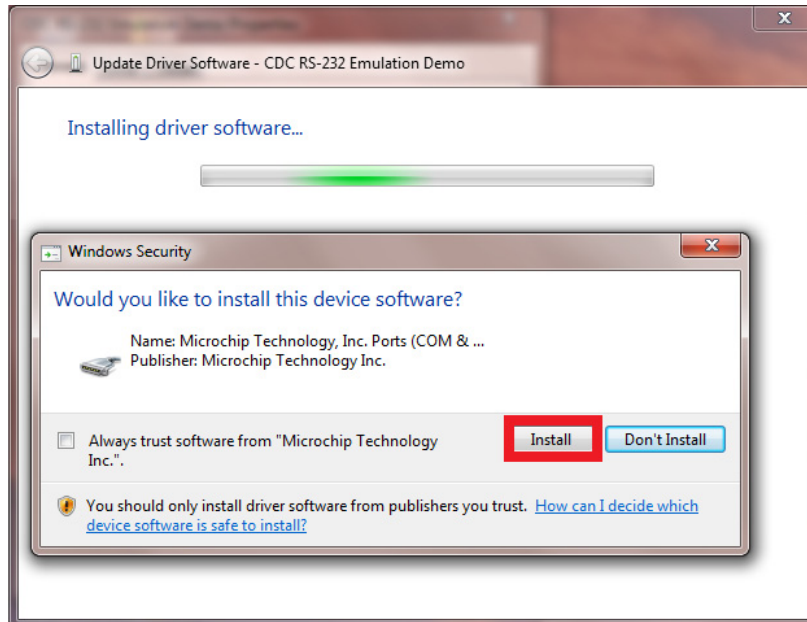

Figure 34. Windows Security Warning

11. Right-click the device. A pop-up menu is displayed.

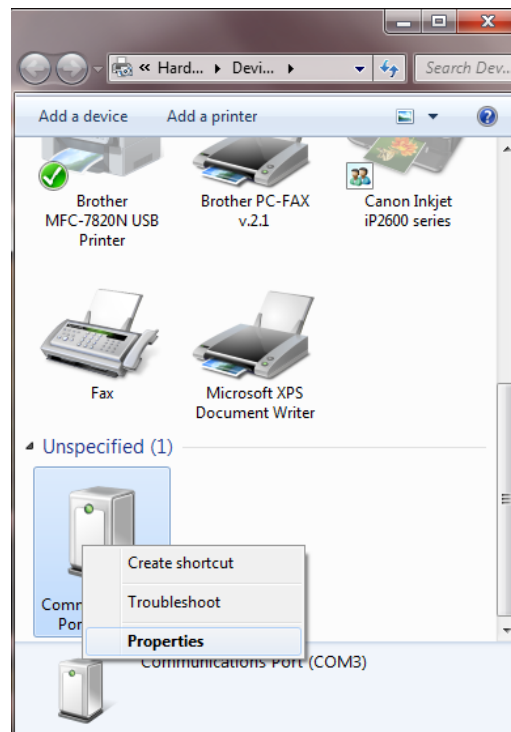

Figure 35. Pop-up Menu

12. Click **Properties**. The Communications Port (COM3) Properties window is displayed.

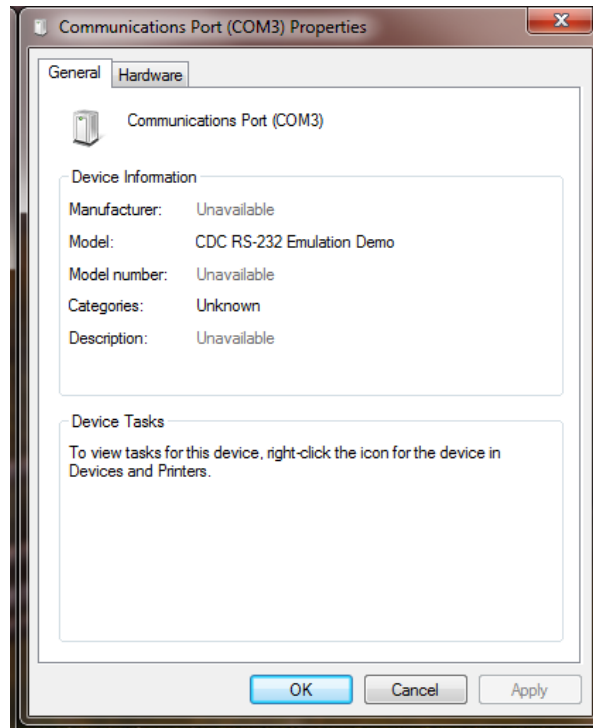

Figure 36. Communications Port (COM3) Properties Window

The next time this device is used, it will be recognized, and installing the driver will not be necessary.

2.2 Installing the CDC Driver Using Windows XP

Follow the instructions below to install the CDC driver on the Windows XP operating system.

1. Connect the provided USB cable from the CRD5490-Z to the PC. Windows XP recognizes the device, and the Found New Hardware Wizard opens. Select to install from a specific location.

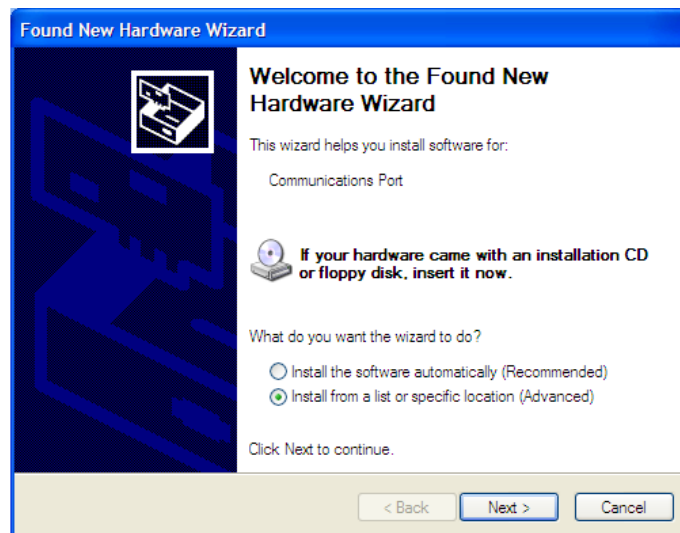

Figure 37. Found New Hardware Wizard Window

- Locate the driver information file provided with the software installation and browse to the driver file:
 \ inf \ win2k_winxp \

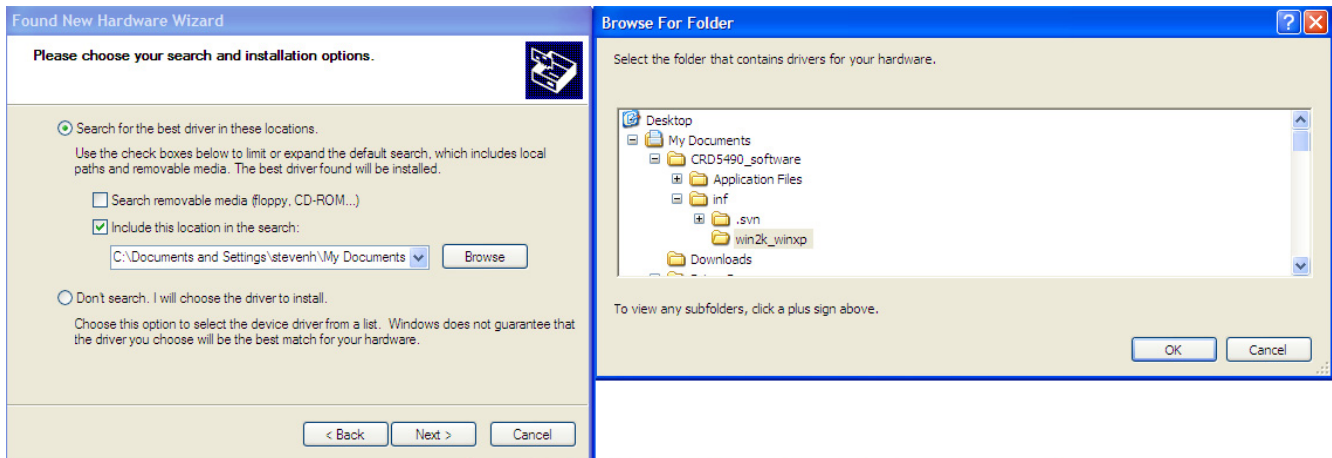

Figure 38. Browse For Folder Window

- Click the **OK** button.
- Click the **Next** and follow the instructions. If warnings are displayed, select to continue.

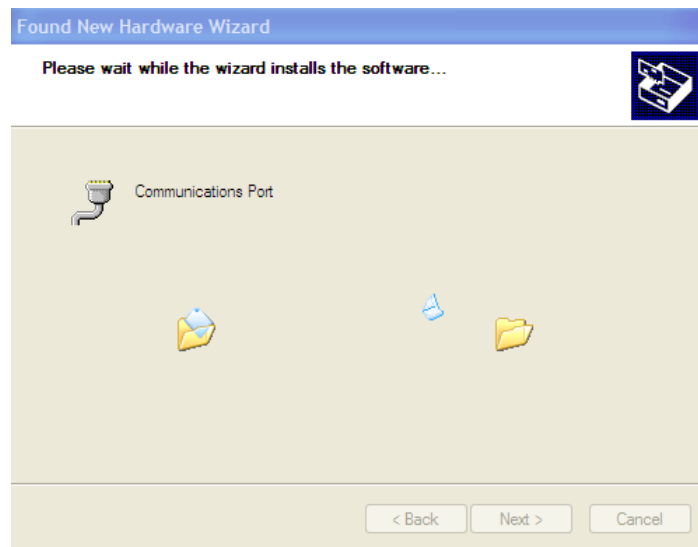

Figure 39. Found New Hardware Wizard Window Showing Files Being Transferred

5. When the installation is complete, click the **Finish** button.

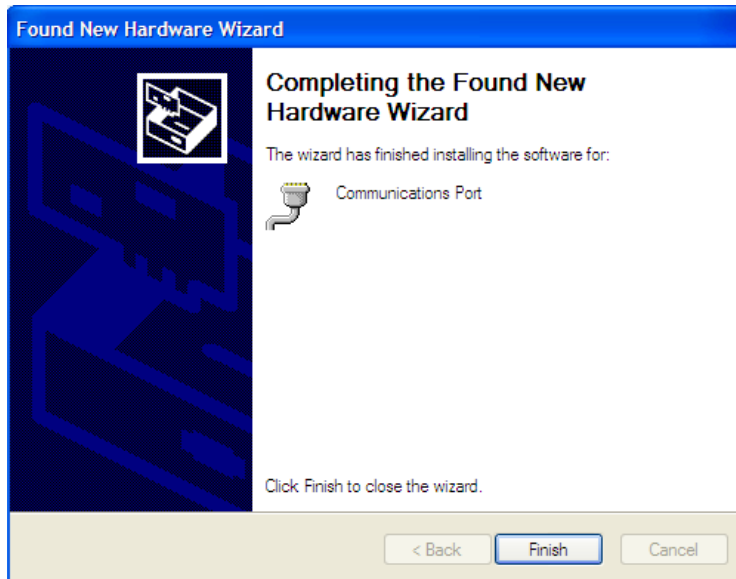

Figure 40. Found New Hardware Wizard Window with a Message that Installation Is Complete

The next time this device is used on the computer, it will be recognized, and the installation of the driver will not be necessary.

APPENDIX 3: NON-FULL SCALE GAIN CALIBRATION

When resources are limited, it may be necessary to provide non-full-scale amplitudes and perform built-in calibration. To perform a non-full-scale calibration, the initial gain register conditions of the device must be identified before calibration. Usually, initial gain register conditions are set to a default value of one, but this is not required. Instead, the initial gain register conditions are set to accommodate the non-full-scale input calibration. Before calibration is executed, the gain register can be set using the following equations:

$$V_{\text{GAIN(pre)}} = \frac{V_{\text{MAX}}}{V_{\text{REF}}} \times 2^{22} \quad [\text{Eq: 1}]$$

$$I_{\text{GAIN(pre)}} = \frac{I_{\text{MAX}}}{I_{\text{REF}}} \times 2^{22} \quad [\text{Eq: 2}]$$

where:

$V_{\text{GAIN(pre)}}$	Value stored in voltage gain register (page 16, address 35) before calibration starts
$I_{\text{GAIN(pre)}}$	Value stored in current gain register (page 16, address 33) before calibration starts
V_{MAX}	Maximum voltage of the meter defined by customer
I_{MAX}	Maximum current of the meter defined by customer
V_{REF}	Voltage of the line just before calibration as measured with reference meter assumes stable input
I_{REF}	Load current just before calibration as measured with reference meter assumes stable input

Follow the steps below to perform a non-full-scale gain calibration:

1. Set the line voltage and load current V_{REF} and I_{REF} , respectively.
2. Confirm that the reference meter shows V_{REF} and I_{REF} of the input.
3. Set $V_{\text{GAIN(pre)}}$ per Equation 1 and $I_{\text{GAIN(pre)}}$ per Equation 2.
4. Send the calibration command.
5. After calibration, the meter will be adjusted for a full-scale voltage of V_{MAX} and I_{MAX} and will currently be measuring the V_{REF} and I_{REF} measurements.

Reference Limits

The calibration line voltage (V_{REF}) or load current (I_{REF}) must not be set too low. It is recommended to keep the register values at a minimum of $\frac{1}{2}$ of the maximum levels. Since the gain register can be set to a maximum value of 4, the input could be set to $\frac{1}{4}$ of the maximum levels. It is not recommended to set the input to $\frac{1}{4}$ of the maximum levels due to variations in setup conditions. If the input is too low, the gain register will set the default value of one after calibration.

Current Scale Register

To perform calibration with less than full scale load *without using the above procedure*, it is possible to set the current channel's *Scale* register. The current channel calibration data path contains a *Scale* register (page 18, address 63) that can be adjusted before calibration to accommodate the non-full-scale load.

$$I_{\text{SCALE}} = \frac{I_{\text{REF}}}{I_{\text{MAX}}} \times 0.6 \times 2^{23} \quad [\text{Eq: 3}]$$

where:

I_{SCALE}	Value stored in the SCALE register before calibration
I_{MAX}	Maximum current of the meter defined by the customer
I_{REF}	Load current before calibration, as measured with a reference meter, assuming stable input

Follow the steps below to set the current channel's *Scale* register.

1. Set the load current, I_{REF} (assuming V_{REF} is set to full scale).
2. Confirm that the reference meter shows V_{REF} and I_{REF} of the input.
3. Set I_{SCALE} per Equation 3.
4. Send the calibration command.
5. After calibration, the meter will be adjusted for a full-scale voltage of V_{MAX} and I_{MAX} and will currently be measuring the V_{REF} and I_{REF} measurements.
6. The *Scale* register is not in the normal data path but instead in the calibration path.

4. SCHEMATIC

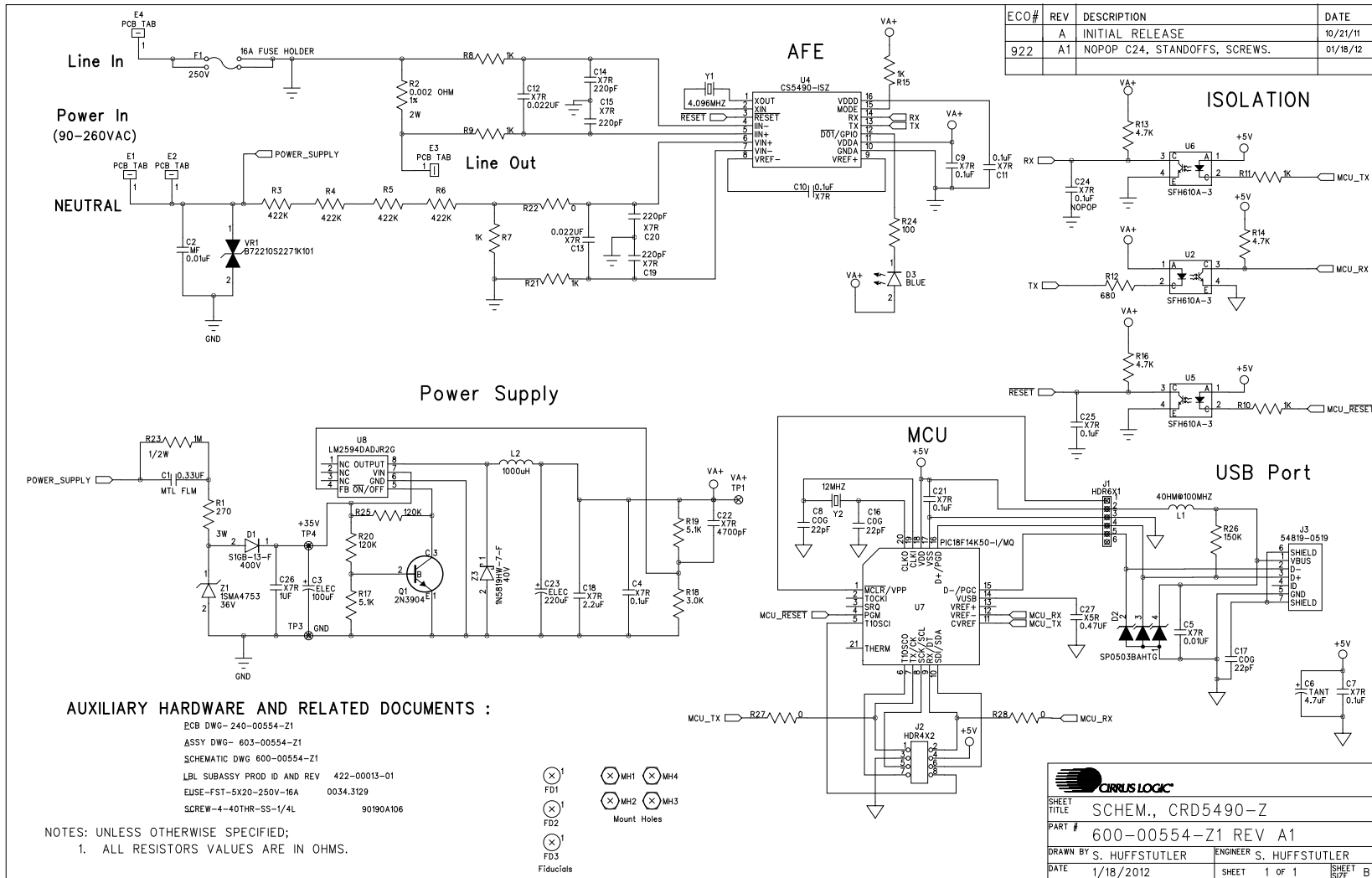

AUXILIARY HARDWARE AND RELATED DOCUMENTS :

- PCB DWG- 240-00554-Z1
- ASSY DWG- 603-00554-Z1
- SCHEMATIC DWG 600-00554-Z1
- LBL SUBASSY PROD ID AND REV 422-00013-01
- EU5E-FST-5X20-250V-16A 0034.3129
- SCREW-4-40THR-SS-1/4L 90190A106

- (X)1 FD1
 - (X)1 FD2
 - (X)1 FD3
 - (X)1 MH1 (X)1 MH4
 - (X)1 MH2 (X)1 MH3
- Mount Holes
- Fiducials

NOTES: UNLESS OTHERWISE SPECIFIED;
1. ALL RESISTOR VALUES ARE IN OHMS.

ECO#	REV	DESCRIPTION	DATE
	A	INITIAL RELEASE	10/21/11
	A1	NOPOP C24, STANDOFFS, SCREWS.	01/18/12

SHEET TITLE SCHEM., CRD5490-Z	
PART # 600-00554-Z1 REV A1	
DRAWN BY S. HUFFSTUTLER	ENGINEER S. HUFFSTUTLER
DATE 1/18/2012	SHEET 1 OF 1 SHEET SIZE B

5. BILL OF MATERIALS

BOM#: 505-00554-Z1 Rev: A2 BOM Desc: PWA CRD5490-Z-NPb														
Date Generated: 03/21/2012														
Line Item	Part Ass	Cirrus PN	Rev	Description	Status	Qty	UM	Ref Desg	Man'f	Man'f PN	ECO	Effective Date	Notes	LTime
0001	P	011-00068-Z1	A	CAP 0.33uF ±10% 310V MTL FLN NPb TH	A	1	EA	C1	BC COMPONENTS	BFC233912334				7
0002	P	011-00051-Z1	A	CAP 10nF ±20% 440V MTL FLN NPb TH	A	1	EA	C2	BC COMPONENTS	BFC233814103				7
0003	P	012-00198-Z1	A	CAP 100uF ±20% 50V ELE NPb RAD 8X12	A	1	EA	C3	UNITED CHEMI-CON	ELX2500ELL101MH12D				7
0004	P	001-02189-Z1	A	CAP 0.1uF ±10% 16V X7R NPb 0603	A	7	EA	C4 C7 C9 C10 C11 C21 C25	KEMET KOA VENKEL PANASONIC NIC COMPONENTS WALSIN	C0603C104K4RAC X7R0603CTTD104K C0603X7R160-104KNE ECJ1VB1C104K NMC0603X7R104K16TR PF 0603B104K160CT	ECO922			0
0005	P	001-01997-Z1	A	CAP 0.01uF ±10% 25V X7R NPb 0603	A	1	EA	C5	KEMET KOA PANASONIC	C0603C103K3RAC X7R0603ETTD103K ECJ1VB1E103K				7
0006	P	004-00068-Z1	A	CAP 4.7uF ±10% 10V NPb TANT CASE A	A	1	EA	C6	KEMET VENKEL AVX	T491A475K010AT TA010TCM475KAR TAJA475K010R				7
0007	P	001-10127-Z1	A	CAP 22pF ±10% 50V C0G NPb 0603	A	1	EA	C8	KEMET WALSIN	C0603C220K5GAC 0603N220K500LT				7
0008	P	001-02068-Z1	A	CAP 0.022uF ±10% 50V X7R NPb 0603	A	2	EA	C12 C13	KEMET PANASONIC	C0603C22K5RAC ECJ1VB1H223K				7
0009	P	001-01621-Z1	A	CAP 220pF ±5% 50V X7R NPb 0603	A	4	EA	C14 C15 C19 C20	KEMET KOA PANASONIC	C0603C221J5RAC X7R0603HTTD221J ECJ1VB1H221J				7
0010	P	001-10048-Z1	A	CAP 22pF ±5% 50V C0G NPb 0603	A	1	EA	C16	NIC COMPONENTS PANASONIC WALSIN	NMC0603NPO220J50TR PF ECJ1VC1H220J 0603N220J500LT				7
0011	P	001-02780-Z1	A	CAP 22pF ±10% 50V C0G NPb 0805	A	1	EA	C17	KEMET KOA PANASONIC	C0805C220K5GAC NPO0805HTTD220K ECJ2VC1H220K				7
0012	P	001-10193-Z1	A	CAP 2.2uF ±10% 10V X7R NPb 0805	A	1	EA	C18	KEMET	C0805C225K8RAC				7
0013	P	001-01937-Z1	A	CAP 4700pF ±10% 50V X7R NPb 0603	A	1	EA	C22	KEMET PANASONIC WALSIN	C0603C472K5RAC ECJ1VB1H472K 0603B472K500CT				7
0014	P	012-00212-Z1	A	CAP 680uF ±20% 10V ELEC NPb CASE F	A	1	EA	C23	PANASONIC	EEEFK1A681F	ECO937			7
0015	P	001-10152-Z1	A	CAP 1uF ±10% 50V X7R NPb 1206	A	1	EA	C26	TDK	C3216X7R1H105K				7
0016	P	001-10192-Z1	A	CAP 0.47uF ±10% 10V X5R NPb 0603	A	1	EA	C27	KEMET WALSIN	C0603C474K8PAC 0603X474K100CT				7
0017	P	070-00173-Z1	A	DIODE RECT 1A 400V NPb SMB	A	1	EA	D1	DIODES INC	S1GB-13-F				7
0018	P	070-00055-Z1	A	DIODE ARRAY 5V (TVS) ESD NPb SOT143	A	1	EA	D2	LITTELFUSE	SP0503BAHTG				89.999
0019	P	165-00060-Z1	A	LED BLU 470nm 5mA 45MCD NPb 0603	A	1	EA	D3	OSRAM	LB Q39G-L2N2-35-1	ECO922		SEE COMMENTS	7
0020	P	110-00340-Z1	A	CON TERM .11PCB TAB NPb TH	A	4	EA	E1 E2 E3 E4	TYCO	61968-1				0
0021	P	303-00008-Z1	A	FUSE CLIP PC MOUNT 5MM NPb	A	2	EA	F1	KEystone	3517	ECO922		SEE COMMENTS	7
0023	P	115-00162-Z1	A	HDR 6x1 ML .1"CTR 062 S GLD NPb TH	A	1	EA	J1	SAMTEC	TSW-106-07-G-S				19.999
0024	P	115-00258-Z1	A	HDR 4x2 ML .1" 093BD ST GLD NPb TH	A	1	EA	J2	SAMTEC TONGYUEQING	TSW-104-08-G-D PHED-DS008G1ABONA				7
0025	P	110-00263-Z1	A	CON USB RCPT RA 5POS MINI-B NPb TH	A	1	EA	J3	MOLEX	54819-0519				7
0026	P	145-00040-Z1	A	FE 1.5A 80 ohm@100MHz NPb 0805	A	1	EA	L1	STEWART	MI0805K400R-10				7
0027	P	040-00149-Z1	A	IND 1000uH ±10% 300mA NPb RAD	A	1	EA	L2	BOURNS	RLB0914-102KL				7
0028	P	304-00004-Z1	A	SPCR STANDOFF 4-40 THR .500"L NPb	A	0	EA	MH1 MH2 MH3 MH4	KEystone JIAXINGLONG	2203 M3X13	ECO922		NO POP	7
0029	P	071-00046-Z1	A	TRAN SIG NPN 40V 0.2A NPb TO-92	A	1	EA	Q1	FAIRCHILD SEMICONDUCTOR	2N3904				7

Figure 41. Bill of Materials (Page 1 of 2)



BOM#: 505-00554-Z1 Rev: A2 BOM Desc: PWA CRD5490-Z-NPb														
Date Generated: 03/21/2012														
Line Item	Part Ass	Cirrus PN	Rev	Description	Status	Qty	UM	Ref Desc	Man'f	Man'f PN	ECO	Effective Date	Notes	LTime
0030	P	031-00054-Z1	A	RES 270 OHM 3W ±5% MTL FLM NPb AXL	P	1	EA	R1	PANASONIC	ERG3SJ271				30.002
0031	P	020-06493-Z1	A	RES 0.002 OHM 2W ±1% NPb 2512	A	1	EA	R2	STACKPOLE ELECTRONICS	CNSL2512FT2L00				7
0032	P	020-06362-Z1	A	RES 422k OHM 1/4W ±1% NPb 1206	A	4	EA	R3 R4 R5 R6	DALE	CRCW1206422KFKEA				7
0033	P	020-01016-Z1	A	RES 1k OHM 1/10W ±1% NPb 0603 FILM	A	7	EA	R7 R8 R9 R10 R11 R15 R21	DALE KOA WALSIN	CRCW06031K00FKEA RK73H1JTTD1001F WR06X1001FTL				7
0034	P	021-00238-Z1	A	RES 680 OHM 1/10W ±5% NPb 0603 FILM	A	1	EA	R12	KOA NIC COMPONENTS	RK73B1JTTD681J NRC06J681TRF				7
0035	P	021-00258-Z1	A	RES 4.7k OHM 1/10W ±5% NPb 0603 FLM	A	3	EA	R13 R14 R16	DALE VENKEL PANASONIC NIC COMPONENTS YAGEO WALSIN	CRCW0603680RJNEA ERJ3GEYJ681V CR0603-10W-472JT ERJ3GEYJ472V NRC06J472TRF 9C06031A4701JLHFT WR06X472JTL				7
0036	P	021-00259-Z1	A	RES 5.1k OHM 1/10W ±5% NPb 0603 FIL	A	2	EA	R17 R19	DALE KOA PANASONIC WALSIN	CRCW06035K10JNEA RK73B1JTTD512J ERJ3GEYJ512V WR06X512JTL				7
0037	P	021-00253-Z1	A	RES 3k OHM 1/10W ±5% NPb 0603 FILM	A	1	EA	R18	DALE PANASONIC	CRCW06033K00JNEA ERJ3GEYJ302V				7
0038	P	021-00292-Z1	A	RES 120k OHM 1/10W ±5% NPb 0603 FIL	A	2	EA	R20 R25	DALE NIC COMPONENTS KOA PANASONIC	CRCW0603120KJNEA NRC06J124TRF RK73B1JTTD124J ERJ3GEYJ124V				7
0039	P	020-00673-Z1	A	RES 0 OHM 1/10W ±5% NPb 0603 FILM	A	3	EA	R22 R27 R28	DALE NIC COMPONENTS PANASONIC VENKEL WALSIN	CRCW060300020EA NRC060620TRF ERJ3EKFOR00V CR0603-10W-000T WR06X000FTL				7
0040	P	031-00070-Z1	A	RES 1M OHM 1/2W ±5% CF NPb AXL	A	1	EA	R23	STACKPOLE	CFM12JT1M00	ECO937		ALT LINE 60	7
0041	P	021-00218-Z1	A	RES 100 OHM 1/10W ±5% NPb 0603 FILM	A	1	EA	R24	DALE KOA YAGEO NIC COMPONENTS PANASONIC WALSIN	CRCW0603100RJNEA RK73B1JTTD101J 9C06031A1000JLHFT NRC06J101TRF ERJ3GEYJ101V WR06X101JTL				7
0042	P	021-00294-Z1	A	RES 150k OHM 1/10W ±5% NPb 0603	A	1	EA	R26	DALE KOA PANASONIC	CRCW0603150KJNEA RK73B1JTTD154J ERJ3GEYJ154V				7
0043	P	110-00045-Z1	A	CON TEST PT .1"CTR TIN PLAT NPb BLK	A	3	EA	TP1 TP3 TP4	KEYSTONE CGG	5001 TP-105 (BLK)				7
0044	P	175-00030-Z1	A	OPT COUPLER PHOTOTRANS NPb DIP4	A	3	EA	U2 U5 U6	VISHAY	SFH610A-3				7
0045	P	065-00334-Z3	B0	IC CRUS ENER MEAS NPb SOIC16L	I	1	EA	U4	CIRRUS LOGIC	CS5490-ISZ/B0				7
0046	P	062-00242-Z1	A	IC MCU 8b FLASH 768kx16 NPb QFN20	A	1	EA	U7	MICROCHIP	PTC18P14K50-I/MQ				7
0047	P	060-00614-Z1	A	IC CONV SW BUCK 0.5A NPb SOIC8	A	1	EA	U8	ON SEMICONDUCTOR	LM2594DADJR2G				7
0048	P	036-00018-Z1	A	VARISTOR 275Vrms 10MM NPb RAD	A	1	EA	VR1	EPCOS EPCOS	B72210S2271K101 S10K275E2				7
0049	P	300-00004-Z1	A	SCREW 4-40X1/4"L PH STEEL NPb	A	0	EA	XMH1 XMH2 XMH3 XMH4	MCMMASTER-CARR	90190A106	ECO922		NO POP	7
0050	P	100-00132-Z1	A	XTL 4.096MHZ 30ppm 18pF NPb SMD	A	1	EA	Y1	ABRACON	ABLS2-4.096MHZ-D4Y-T				7
0051	P	100-00134-Z1	A	XTL 12.0MHZ 18pf 30p NPb HC49/US SM	A	1	EA	Y2	CTS	ATS120BSM-1				7
0052	P	070-00209-Z1	A	DIODE ZEN 36V 1W 5% NPb SMA	A	1	EA	Z1	TAIWAN SEMICONDUCTOR	1SMA4753				7
0053	P	070-00210-Z1	A	DIODE SCHOTTKY 40V 1A NPb SOD123	A	1	EA	Z3	DIODES INC	1N5819HW-7-F				0
0054	P	240-00554-Z1	A	PCB CRD5490-Z-NPb	A	1	EA		CIRRUS LOGIC	240-00554-21				7
0055	P	603-00554-Z1	A1	ASSY DWG CRD5490-Z-NPb	A	1	REF		CIRRUS LOGIC	603-00554-21	ECO922			7
0056	P	600-00554-Z1	A2	SCHEM CRD5490-Z-NPb	A	1	REF		CIRRUS LOGIC	600-00554-21	ECO922/937			7
0057	A	422-00013-Z1	D	LBL SUBASSY PRODUCT ID AND REV	A	1	EA		CIRRUS LOGIC	422-00013-01				0
0058	P	180-00024-Z1	A	FUSE 16A 250V TLAG NPb 5x20MM	A	1	EA	ZZ5	SCHURTER INC	0034.3129				7
0059	P	001-02189-Z1	A	CAP 0.1uF ±10% 16V X7R NPb 0603	A	0	EA	C24	KEMET KOA VENKEL PANASONIC NIC COMPONENTS WALSIN	C0603C104K4RAC X7R0603CTTD104K C0603X7R160-104KNE ECJ1VB1C104K NMC0603X7R104K16TR PF 0603B104K160CT	ECO922		NO POP	0

Figure 42. Bill of Materials (Page 2 of 2)



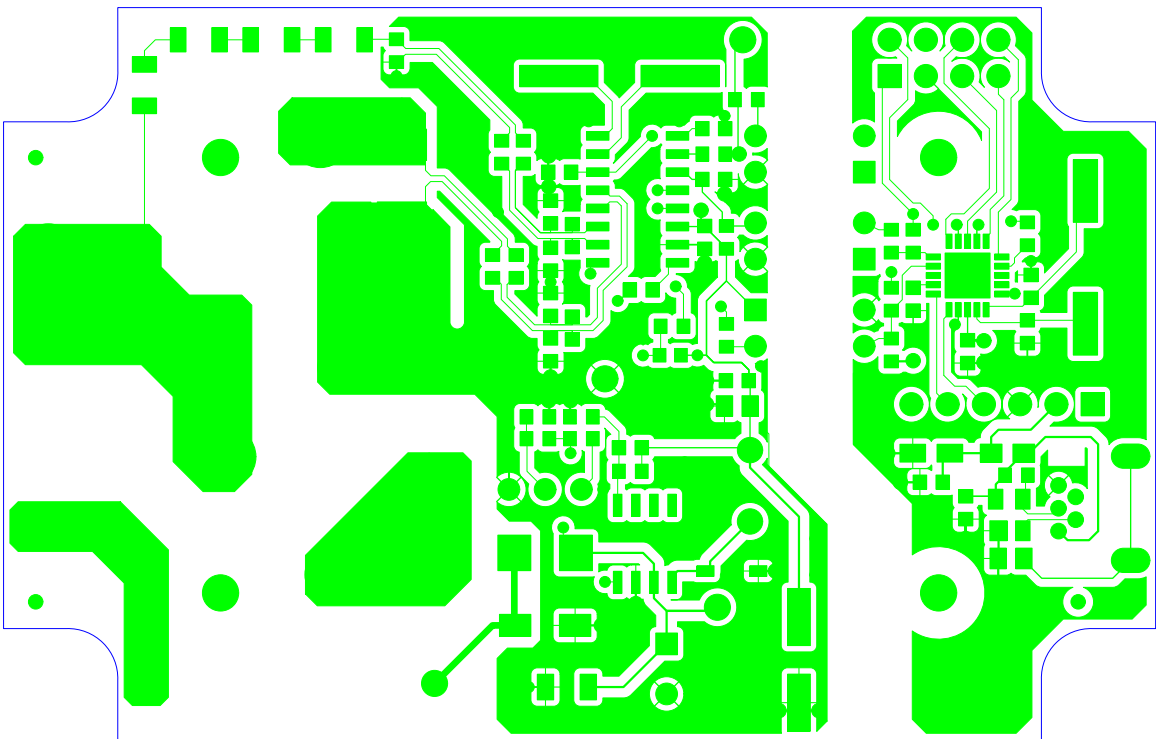

Figure 43. Top Routing

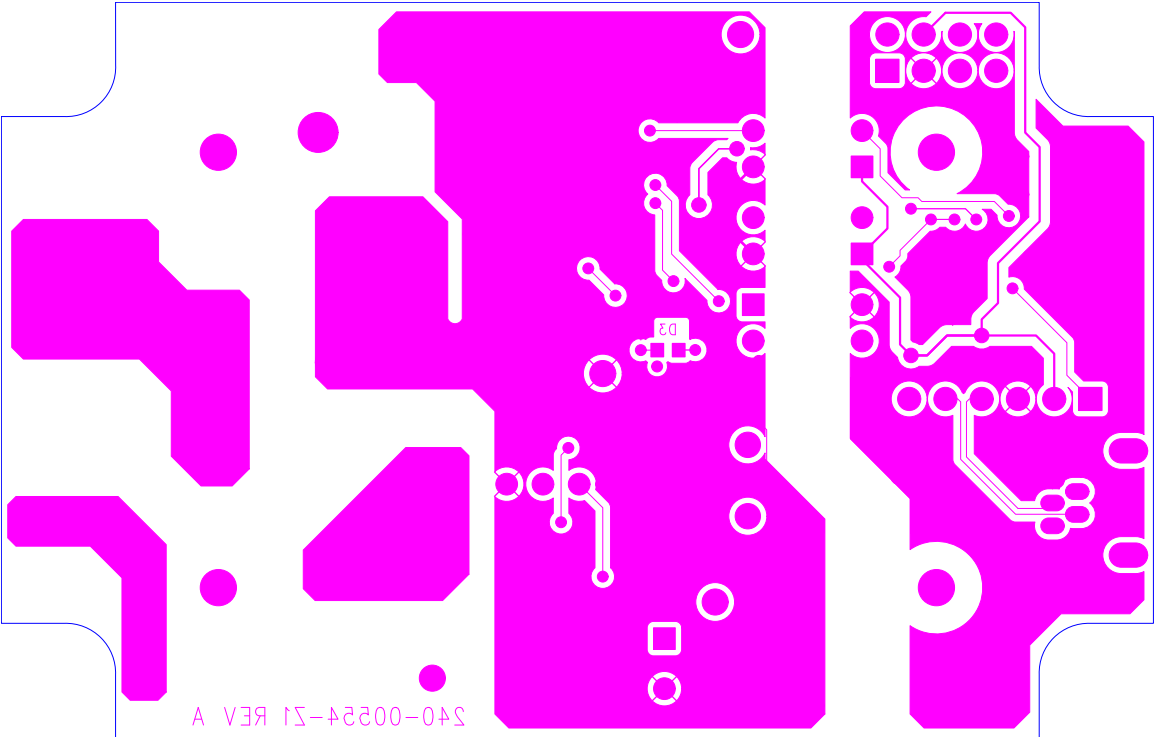

Figure 44. Bottom Routing

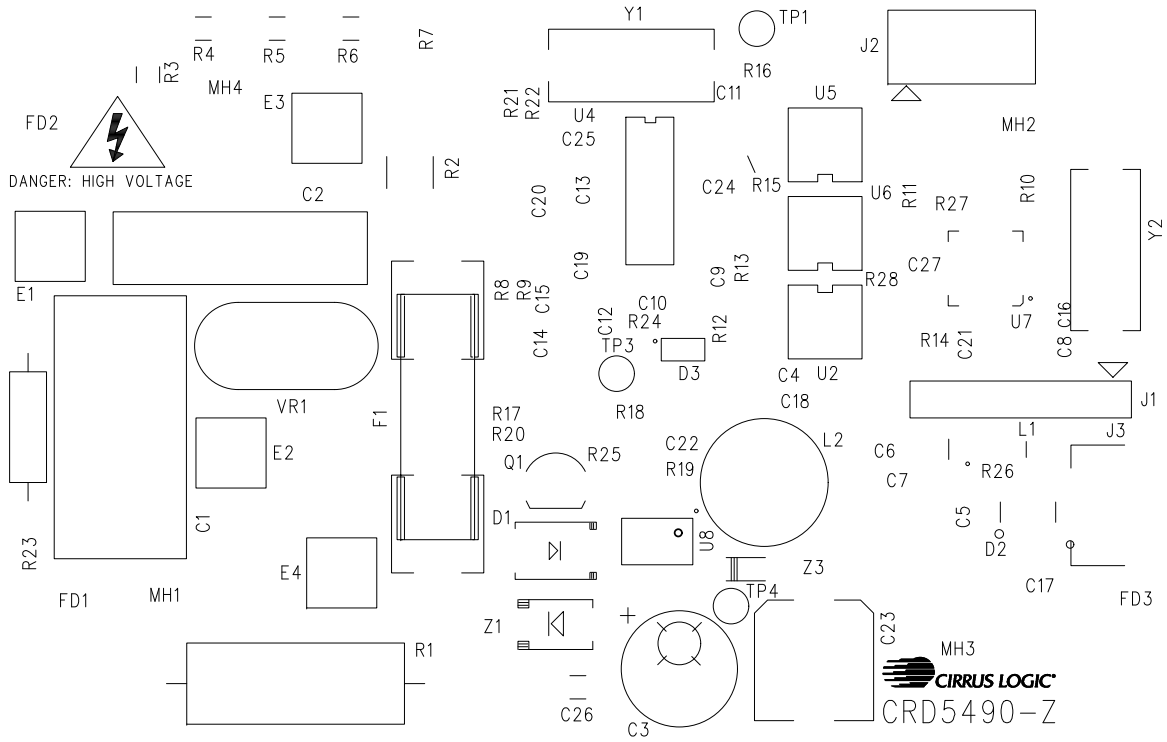

Figure 45. Silkscreen