

# SR320 THRU SR3200

## List

深圳FMS Kinter 131 6803 0058

List.....	1
Package outline.....	2
Features.....	2
Mechanical data.....	2
Maximum ratings .....	2
Rating and characteristic curves.....	3
Pinning information.....	4
Marking.....	4
Taping & bulk specifications for AXIAL devices.....	4
Suggested thermal profiles for soldering processes.....	5
High reliability test capabilities.....	6

# SR320 THRU SR3200

## 3.0A Axial Leaded Schottky Barrier Rectifiers - 20V-200V

### Features

- Axial lead type devices for through hole design
- Low power loss, high efficiency.
- High current capability, low forward voltage drop.
- High surge capability.
- Guardring for overvoltage protection.
- Ultra high-speed switching.
- Silicon epitaxial planar chip, metal silicon junction.
- Lead-free parts meet environmental standards of MIL-STD-19500 /228
- Suffix "-H" for Halogen-free part, ex. SR320-H

### Mechanical data

- Epoxy : UL94-V0 rated flame retardant
- Case : Molded plastic, DO-201AD
- Lead : Axial leads, solderable per MIL-STD-202, Method 208 guaranteed
- Polarity: Color band denotes cathode end
- Mounting Position : Any
- Weight : Approximated 1.10 gram

### Package outline

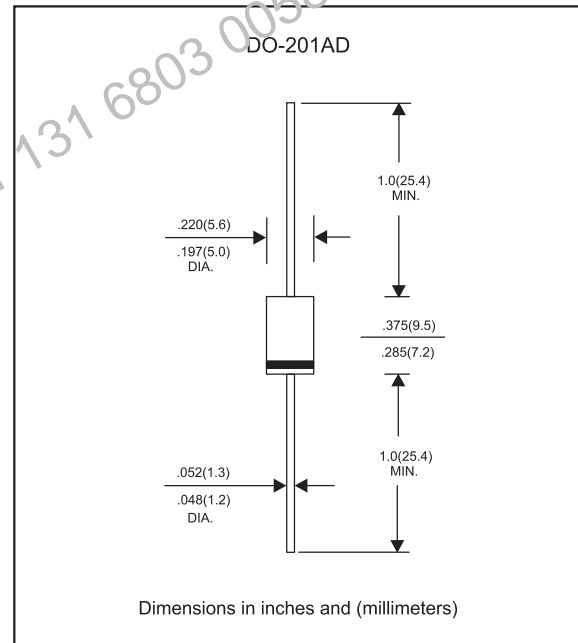

### Maximum ratings and Electrical Characteristics (AT $T_A=25^\circ\text{C}$ unless otherwise noted)

PARAMETER	CONDITIONS	Symbol	MIN.	TYP.	MAX.	UNIT
Forward rectified current	See Fig.2	$I_o$			3.0	A
Forward surge current	8.3ms single half sine-wave superimposed on rate load (JEDEC methode)	$I_{FSM}$			80	A
Reverse current	$V_R = V_{RRM}$ $T_J = 25^\circ\text{C}$	$I_R$			0.5	mA
	$V_R = V_{RRM}$ $T_J = 100^\circ\text{C}$				30	
Thermal resistance	Junction to ambient	$R_{\theta JA}$		40		$^\circ\text{C}/\text{W}$
	Junction to lead	$R_{\theta JL}$		10		$^\circ\text{C}/\text{W}$
Diode junction capacitance	f=1MHz and applied 4V DC reverse voltage	$C_J$		250		pF
Storage temperature		$T_{STG}$	-65		+175	$^\circ\text{C}$

SYMBOLS	$V_{RRM}^{*1}$ (V)	$V_{RMS}^{*2}$ (V)	$V_R^{*3}$ (V)	$V_F^{*4}$ (V)	Operating temperature $T_J$ , ( $^\circ\text{C}$ )
SR320	20	14	20	0.55	-55 to +125
SR330	30	21	30		
SR340	40	28	40		
SR350	50	35	50	0.70	-55 to +150
SR360	60	42	60		
SR380	80	56	80	0.85	
SR3100	100	70	100		
SR3150	150	105	150		
SR3200	200	140	200	0.95	

\*1 Repetitive peak reverse voltage

\*2 RMS voltage

\*3 Continuous reverse voltage

\*4 Maximum forward voltage@ $I_F=3.0\text{A}$

## Rating and characteristic curves (SR320 THRU SR3200)

FIG.1-TYPICAL FORWARD CURRENT DERATING CURVE

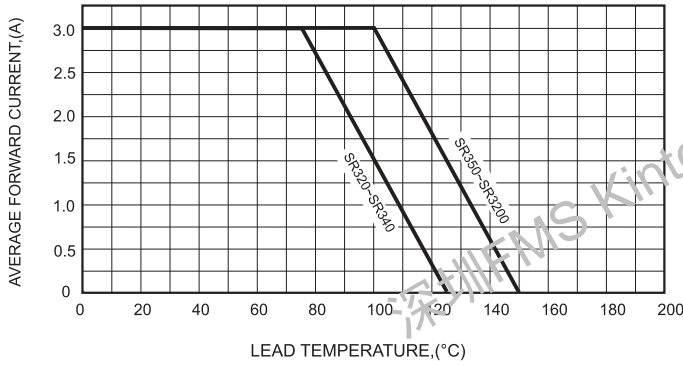

FIG.3-MAXIMUM NON-REPETITIVE FORWARD SURGE CURRENT

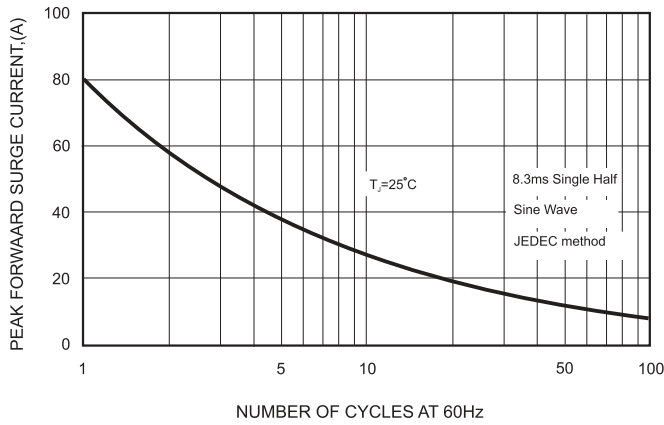

FIG.4-TYPICAL JUNCTION CAPACITANCE

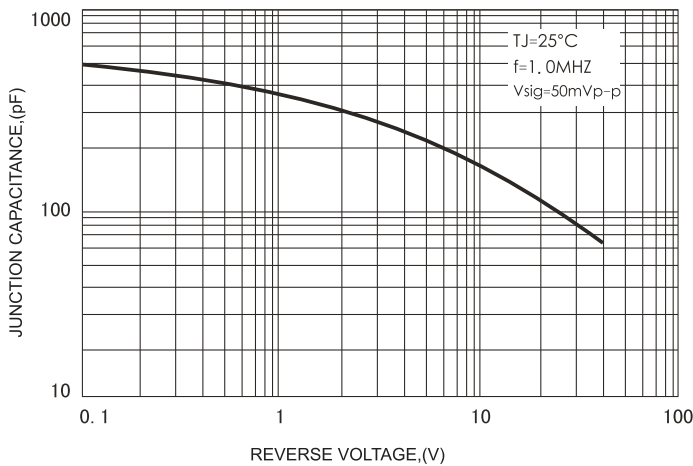

FIG.2-TYPICAL FORWARD CHARACTERISTICS

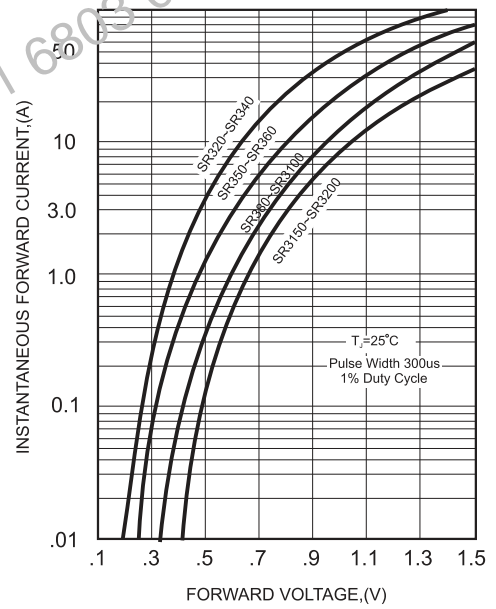
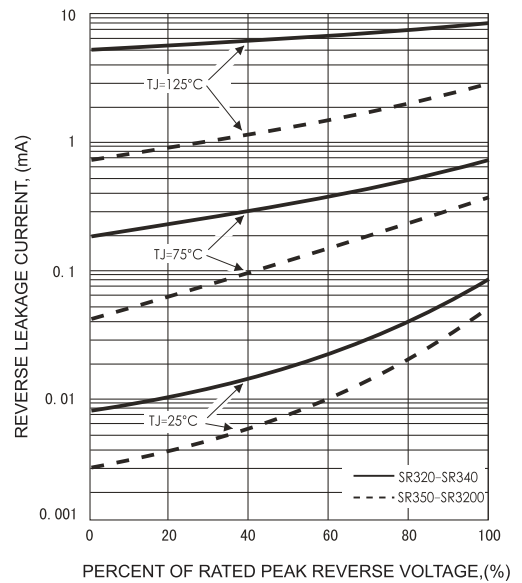



FIG.5 - TYPICAL REVERSE CHARACTERISTICS



## SR320 THRU SR3200

## Pinning information

Pin	Simplified outline	Symbol
Pin1 cathode Pin2 anode		

## Marking

Type number	Marking code
SR320	SR320
SR330	SR330
SR340	SR340
SR350	SR350
SR360	SR360
SR380	SR380
SR3100	SR3100
SR3150	SR3150
SR3200	SR3200

## Taping &amp; bulk specifications for AXIAL devices

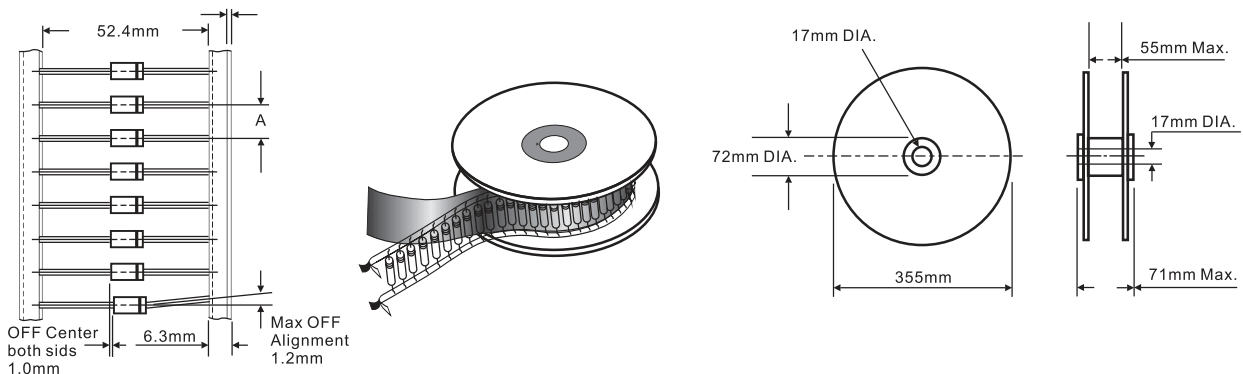

## REEL PACKING

DEVICE CASE TYPE	Q'TY 1 (PCS / REEL)	COMPONENT SPACING "A" in FIG. A	CARTON SIZE (m/m)	Q'TY 2 (PCS / CARTON)	APPROX. CROSS WEIGHT(kg)
DO-201AD	1,200	10 mm	360 * 340 * 370	4,800	9.1

## AMMO PACKING

DEVICE CASE TYPE	Q'TY 1 (PCS / BOX)	INNER BOX SIZE (m/m)	CARTON SIZE (m/m)	Q'TY 2 (PCS / CARTON)	APPROX. CROSS WEIGHT(kg)
DO-201AD	1,200	260 * 83 * 160	440 * 270 * 340	12,000	17.0

# SR320 THRU SR3200

BULK PACKING

DEVICE CASE TYPE	Q'TY 1 (PCS / BOX)	INNER BOX SIZE (m/m)	CARTON SIZE (m/m)	Q'TY 2 (PCS / CARTON)	APPROX. CROSS WEIGHT(kg)
DO-201AD	500	305 * 73 * 40	347 * 320 * 271	12,000	16.4

Suggested thermal profiles for soldering processes

1. Lead free temperature profile wave-soldering

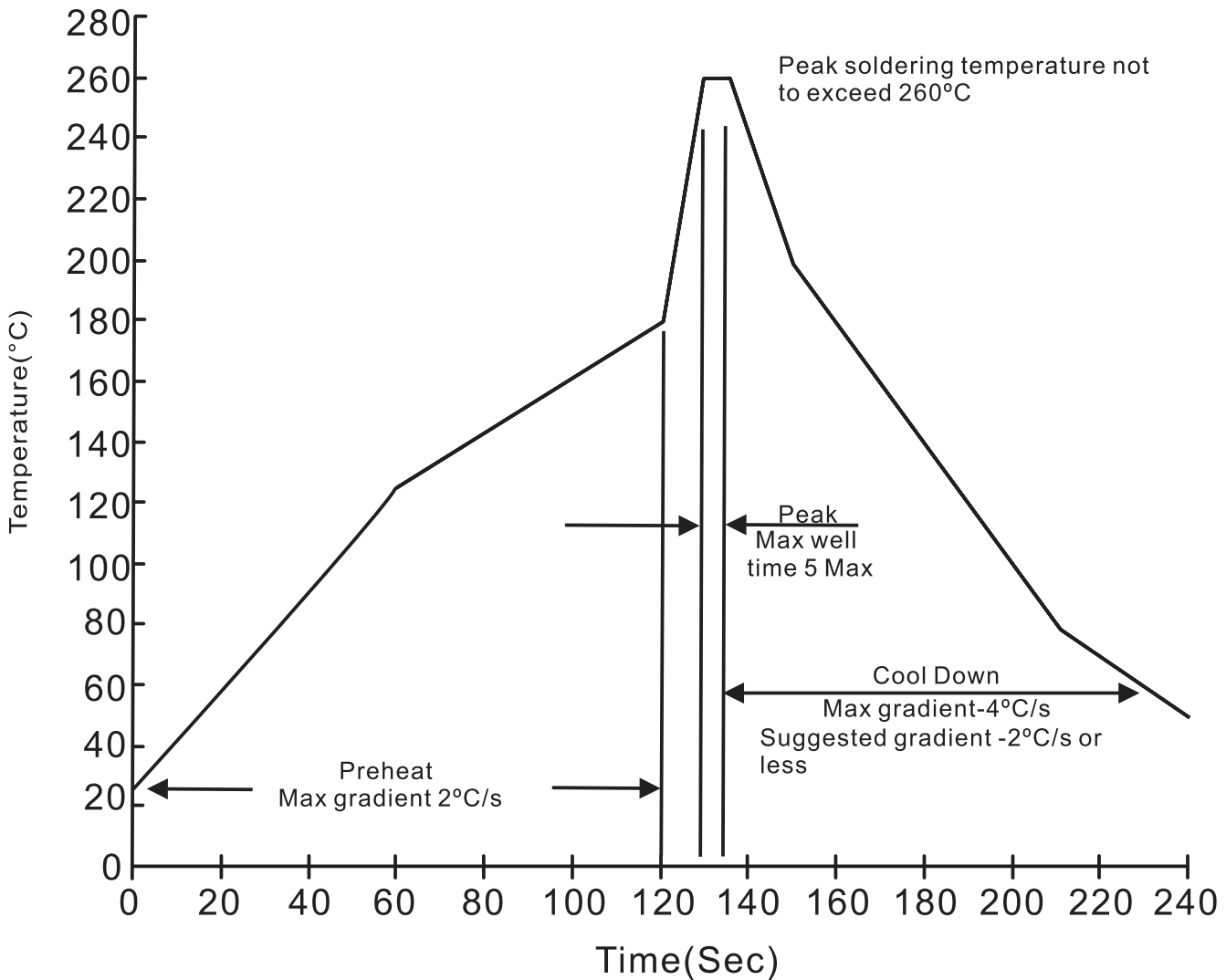

# SR320 THRU SR3200

## High reliability test capabilities

Item Test	Conditions	Reference
1. Solder Resistance	at $260 \pm 5^\circ\text{C}$ for $10 \pm 2$ sec. immerse body into solder $1/16" \pm 1/32"$	MIL-STD-750D METHOD-2031
2. Solderability	at $245 \pm 5^\circ\text{C}$ for 5 sec.	MIL-STD-202F METHOD-208
3. Pull Test	2kg in axial lead direction for 10 sec.	MIL-STD-750D METHOD-2036
4. Bend Lead	2kg weight applied to each lead bending arc $90^\circ \pm 5^\circ$ for 3 times.	MIL-STD-750D METHOD-2036
5. High Temperature Reverse Bias	$V_R = 80\%$ rate at $T_J = 125^\circ\text{C}$ for 168 hrs.	MIL-STD-750D METHOD-1038
6. Forward Operation Life	Rated average rectifier current at $T_A = 25^\circ\text{C}$ for 500hrs.	MIL-STD-750D METHOD-1027
7. Intermittent Operation Life	$T_A = 25^\circ\text{C}$ , $I_F = I_O$ On state: power on for 5 min. off state: power off for 5 min, on and off for 500 cycles.	MIL-STD-750D METHOD-1036
8. Pressure Cooker	$15P_{SIG}$ at $T_A = 121^\circ\text{C}$ for 4 hrs.	JESD22-A102
9. Temperature Cycling	$-55^\circ\text{C}$ to $+125^\circ\text{C}$ dwelled for 30 min. and transferred for 5min. total 10 cycles.	MIL-STD-750D METHOD-1051
10. Thermal Shock	$0^\circ\text{C}$ for 5 min. rise to $100^\circ\text{C}$ for 5 min. total 10 cycles.	MIL-STD-750D METHOD-1056
11. Forward Surge	8.3ms single half sine-wave superimposed on rated load, one surge.	MIL-STD-750D METHOD-4066-2
12. Humidity	at $T_A = 85^\circ\text{C}$ , RH=85% for 1000hrs.	MIL-STD-750D METHOD-1021
13. High Temperature Storage Life	at $175^\circ\text{C}$ for 1000 hrs.	MIL-STD-750D METHOD-1031