

### DESCRIPTION

EV8124-D-00A Evaluation Board is designed to demonstrate the capability of MP8124. MP8124 is a highly integrated voltage regulator to provide efficient, low noise power and the interface signals to a satellite receiver's Low Noise Block (LNB). It generates 22kHz tone signal compatible with DiSEqC 1.x.

The MP8124 integrates a current-mode boost regulator followed by a tracking linear regulator. The boost regulator provides a clean power source which is 1V higher than the final output voltage while the tracking linear regulator protects the output against overloads or shorts.

The MP8124 provides a number of features including bus voltage selection, over current protection and 22kHz tone shaper from external signal. It offers a simple solution with low component count and high efficiency.

The MP8124 is available in a 14-pin QFN (2X3mm) package.

### ELECTRICAL SPECIFICATION

Parameter	Symbol	Value	Units
Input Voltage	$V_{IN}$	8 – 14	V
Output Voltage	$V_{OUT}$	19	V
Output Current	$I_{OUT}$	0-0.5	A

### FEATURES

- Compatible with DiSEqC 1.x
- 600mA Accurate Current Limit
- 8V-to-14V Input Voltage
- 40V Output Voltage Rating
- Low-Noise LDO Output
- High Efficiency for Light Load, >85% at 40mA
- High Frequency for Small Component Size
- Build in 22kHz Signal Shaper
- Selectable Output Voltage
- OCP, SCP Protection
- Boost OVP Protection
- Over Temperature Protection
- 14pin QFN-14 (2mmx3mm) Package

### PACKAGEAPPLICATIONS

- LNB Power Supply and Control for Satellite Set Top Boxes
- TV Satellite Receivers
- PC Card Satellite Receivers

All MPS parts are lead-free and adhere to the RoHS directive. For MPS green status, please visit MPS website under Products, Quality Assurance page.

"MPS" and "The Future of Analog IC Technology", are Registered Trademarks of Monolithic Power Systems, Inc.

### EV8124-D-00A EVALUATION BOARD



(L x W x H) 6.35cm x 6.35cm x 0.6cm

Board Number	MPS IC Number
EV8124-D-00A	MP8124GD

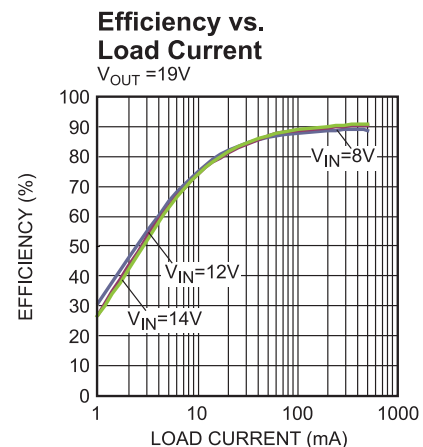

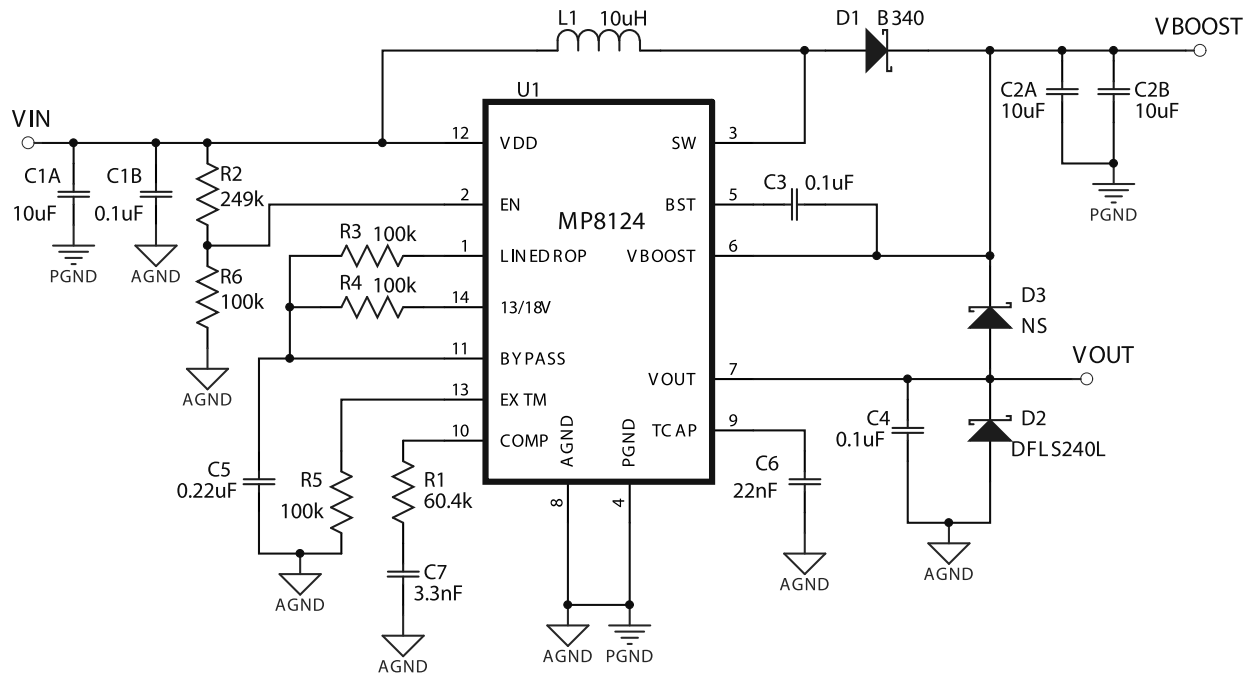
**EVALUATION BOARD SCHEMATIC**

**EV8124-D-00A BILL OF MATERIALS**

Qty	Ref	Value	Description	Package	Manufacturer	Part Number
3	C1A, C2A, C2B	10uF	Ceramic Cap, 25V,X7R	1210	Murata	GRM32DR71E106KA12L
3	C1B, C3, C4	0.1uF	Ceramic Cap,50V,X7R	0603	Murata	GRM188R71H104KA93D
1	C5	0.22uF	Ceramic Cap,25V,X7R	0603	Murata	GRM188R71E224KA88D
1	C6	22nF	Ceramic Cap,25V,X7R	0603	Murata	GRM188R71E223KA01D
1	C7	3.3nF	Ceramic Cap,50V,X7R	0603	Murata	GRM188R71H332KA01D
1	R1	60.4k	Film resistor, 1%	0603	ROYAL	RC0603FR-0760K4L
1	R2	249k	Film resistor, 5%	0603	ROYAL	RC0603JR-07249KL
4	R3, R4, R5, R6	100k	Film resistor, 5%	0603	ROYAL	RC0603JR-07100KL
1	D1	B340	40V,3A, Schottky diode	SMA	Diode Inc	B340A
1	D2	DFLS240L	40V,2A, Schottky diode	PowerDI123	Diode Inc	DFLS240L-7
0	D3	NS				
1	L1	10μH	4.3A, 27mΩ inductor	SMD	Würth	744 771 410 0
1	U1	MP8124	LNB Power Supply and Control Regulator	QFN-14 (2mmX3mm)	MPS	MP8124GD

## EVB TEST RESULTS

$V_{IN} = 12V$ ,  $V_{OUT} = 19V$ ,  $L = 10\mu H$ ,  $T_A = 25^\circ C$ , unless otherwise noted.

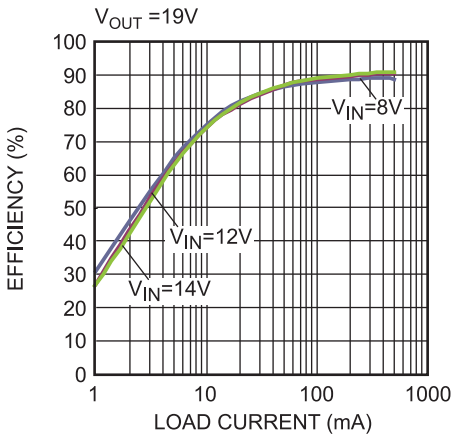
**Efficiency vs. Load Current**



**Efficiency vs. Load Current**

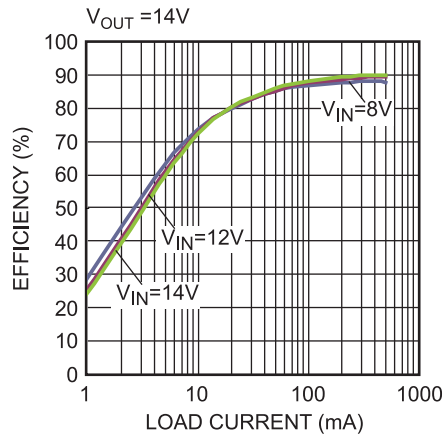

**Load Regulation**

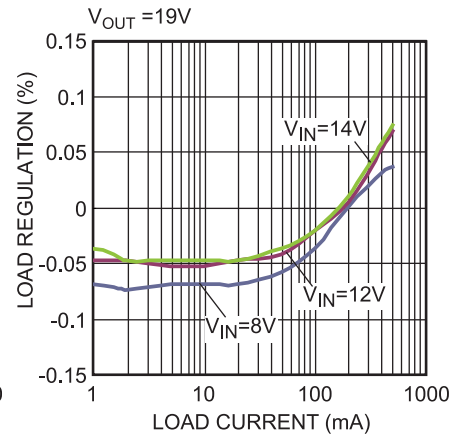

**Load Regulation**

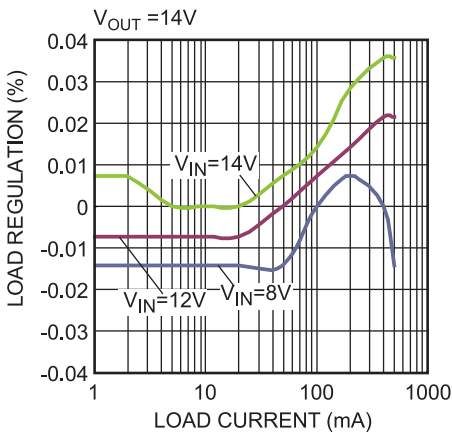

**Line Regulation**

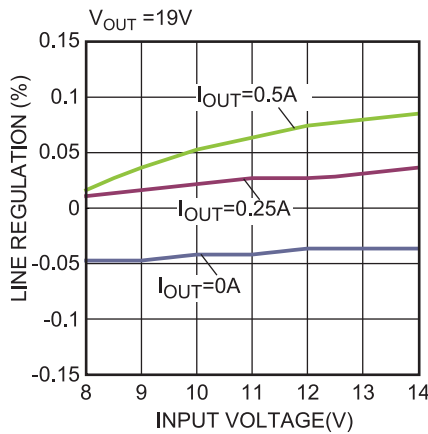

**Line Regulation**

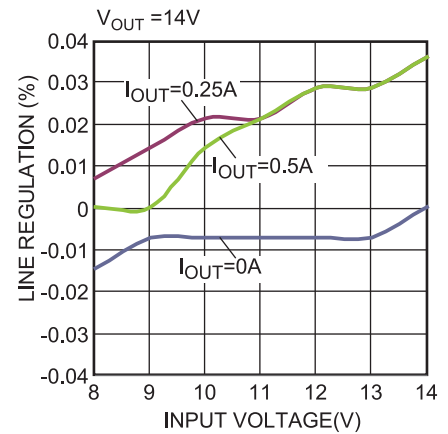

**Bode Plot**

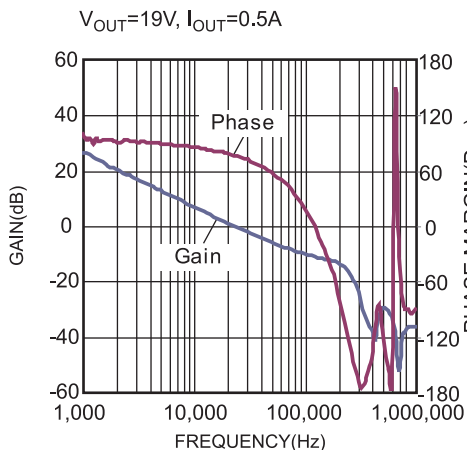

**Bode Plot**

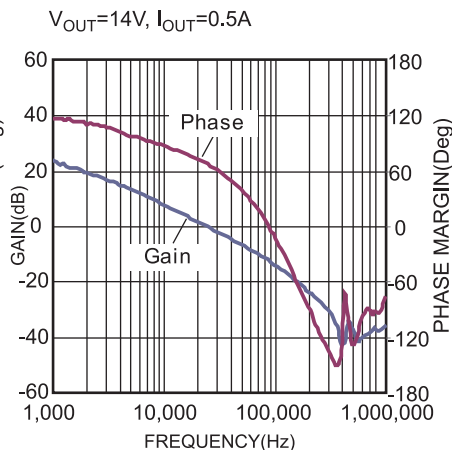

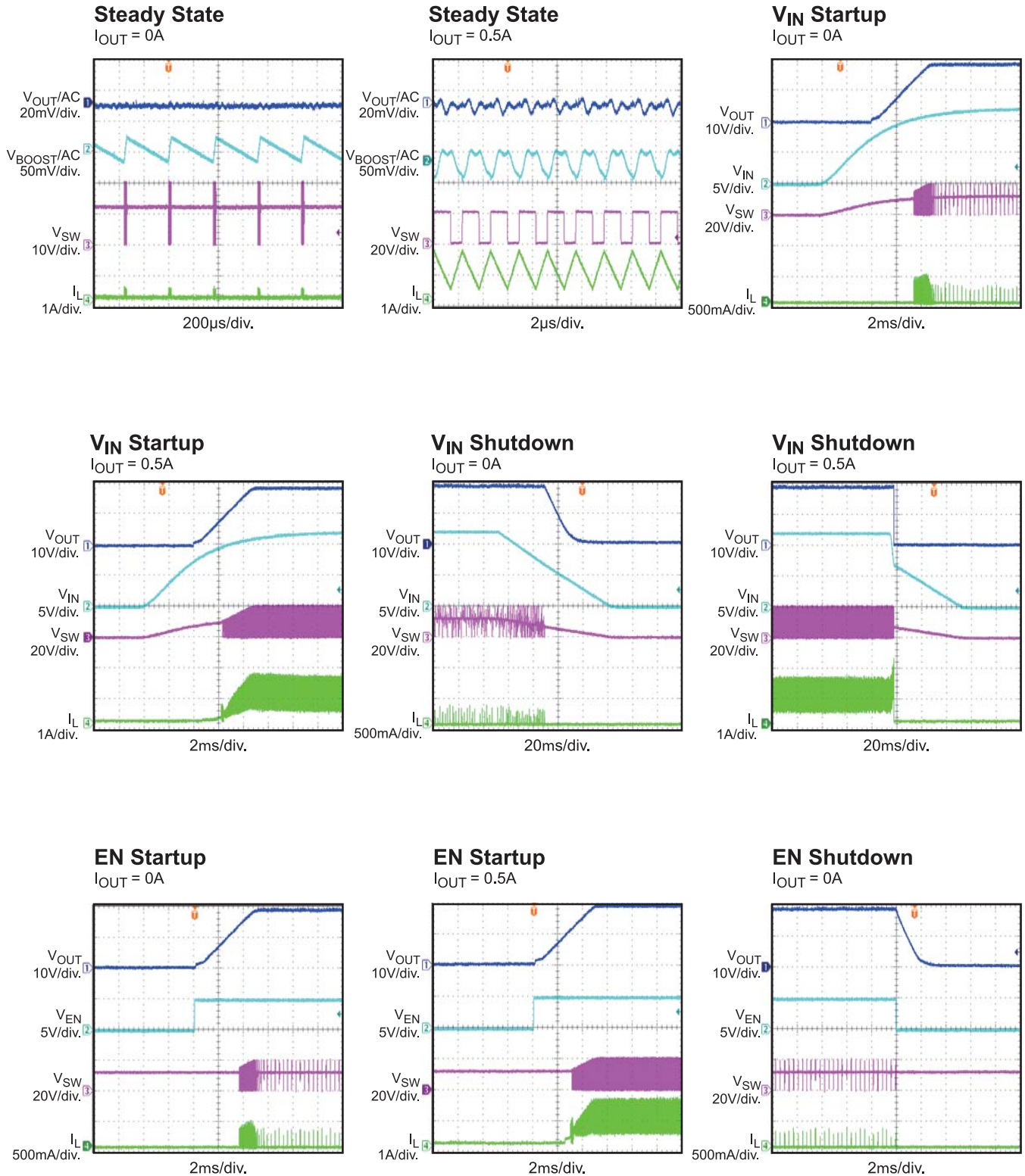
**EVB TEST RESULTS (continued)**
 $V_{IN} = 12V$ ,  $V_{OUT} = 19V$ ,  $L = 10\mu H$ ,  $T_A = 25^\circ C$ , unless otherwise noted.

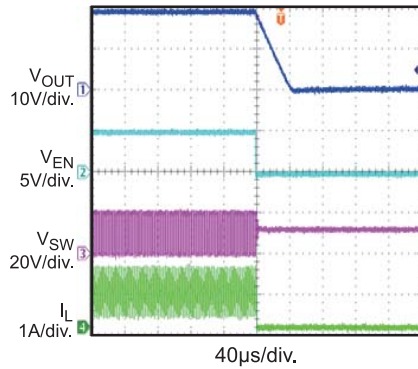
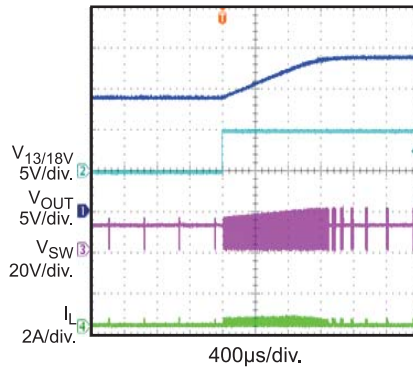
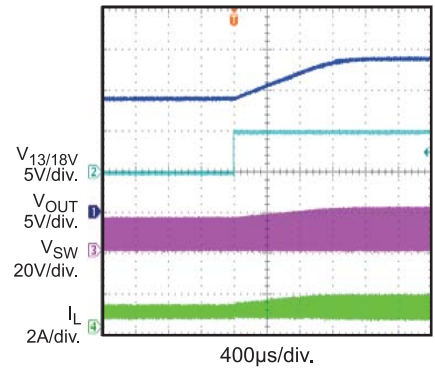
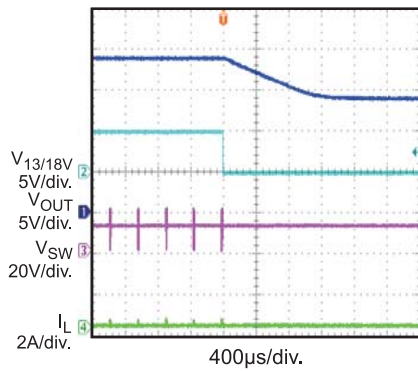
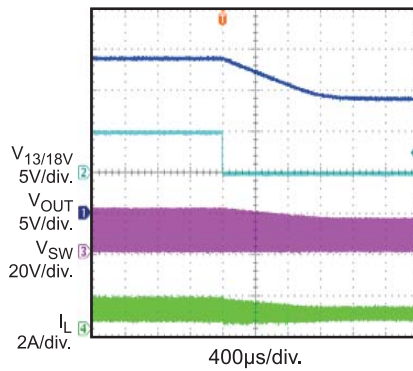
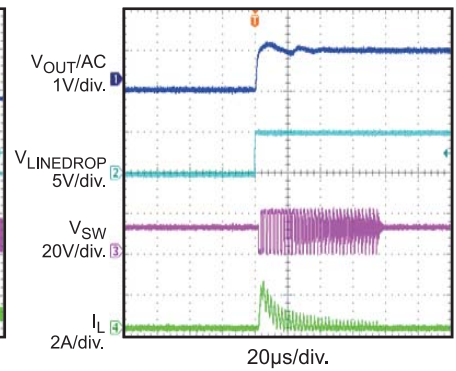
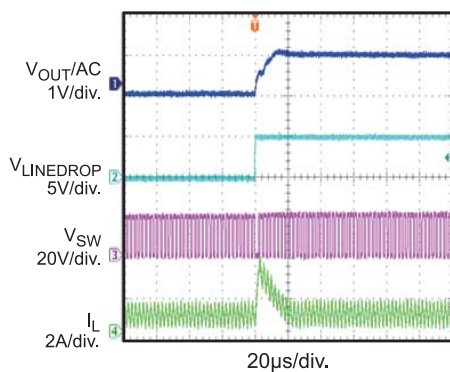
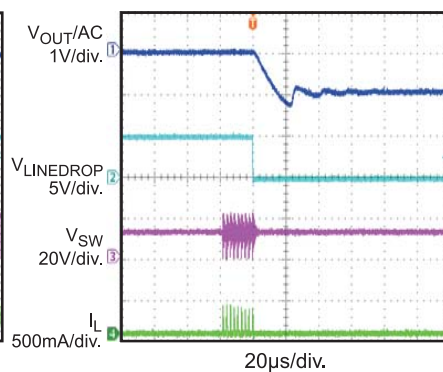
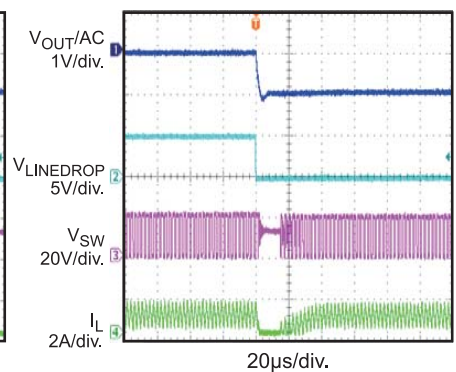
**EVB TEST RESULTS (continued)**
 **$V_{IN} = 12V$ ,  $V_{OUT} = 19V$ ,  $L = 10\mu H$ ,  $T_A = 25^\circ C$ , unless otherwise noted.**
**EN Shutdown**
 $I_{OUT} = 0.5A$ 

**14V to 19V Switching**
 $I_{OUT} = 0A$ 

**14V to 19V Switching**
 $I_{OUT} = 0.5A$ 

**19V to 14V Switching**
 $I_{OUT} = 0A$ 

**19V to 14V Switching**
 $I_{OUT} = 0.5A$ 

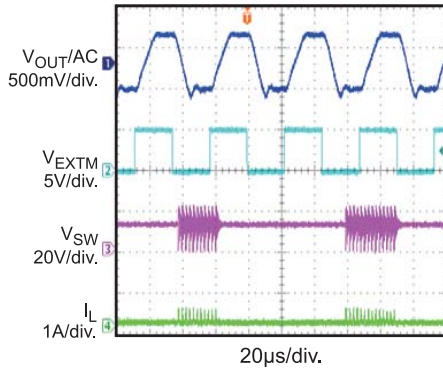
**18V to 19V Switching**
 $I_{OUT} = 0A$ 

**18V to 19V Switching**
 $I_{OUT} = 0.5A$ 

**19V to 18V Switching**
 $I_{OUT} = 0A$ 

**19V to 18V Switching**
 $I_{OUT} = 0.5A$ 

**EVB TEST RESULTS (continued)**

$V_{IN} = 12V$ ,  $V_{OUT} = 19V$ ,  $L = 10\mu H$ ,  $T_A = 25^\circ C$ , unless otherwise noted.

**Tone Steady State**

$I_{OUT} = 0A$



**Tone Steady State**

$I_{OUT} = 0.5A$

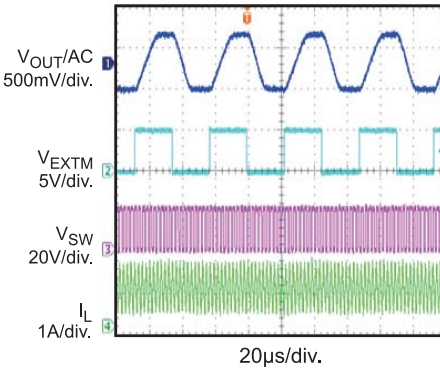

**Tone Entry**

$I_{OUT} = 0A$

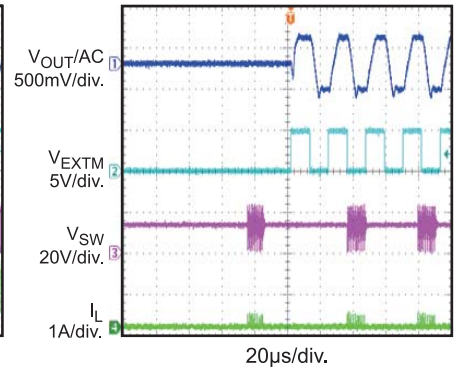

**Tone Entry**

$I_{OUT} = 0.5A$

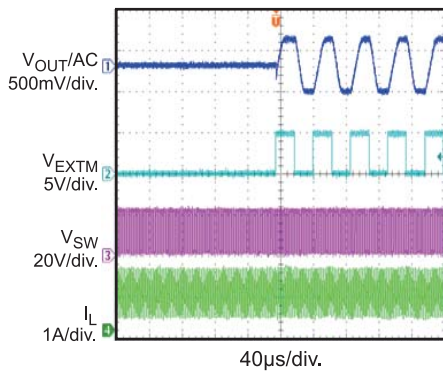

**Tone Exit**

$I_{OUT} = 0A$

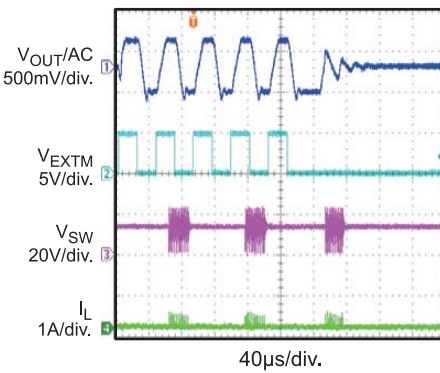

**Tone Exit**

$I_{OUT} = 0.5A$

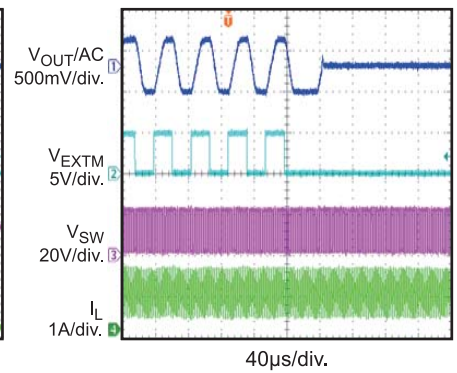

**Tone Burst**

$I_{OUT} = 0A$

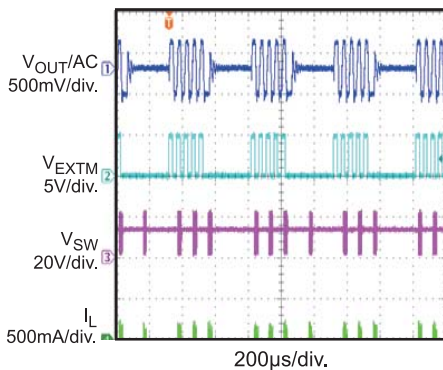

**Tone Burst**

$I_{OUT} = 0.5A$

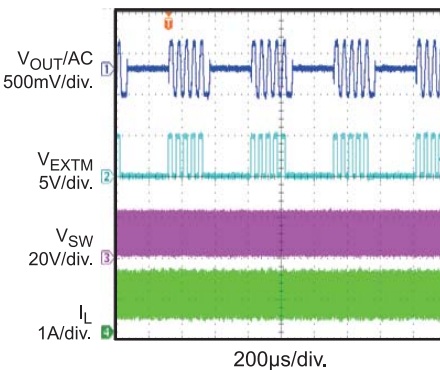

**SCP Entry**

$I_{OUT} = 0A$  to Short

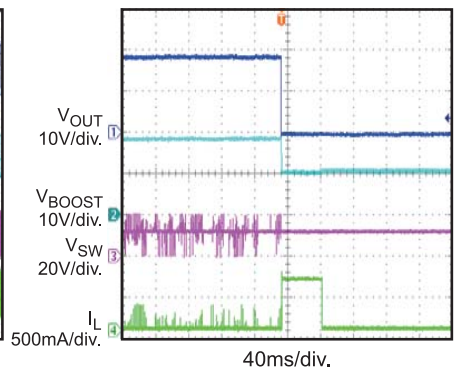

**EVB TEST RESULTS (continued)**
 $V_{IN} = 12V$ ,  $V_{OUT} = 19V$ ,  $L = 10\mu H$ ,  $T_A = 25^\circ C$ , unless otherwise noted.

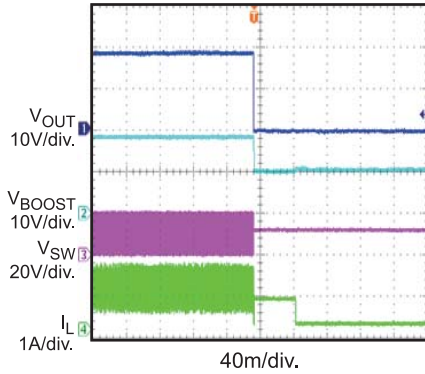
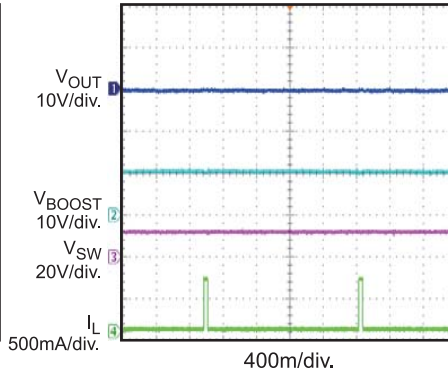
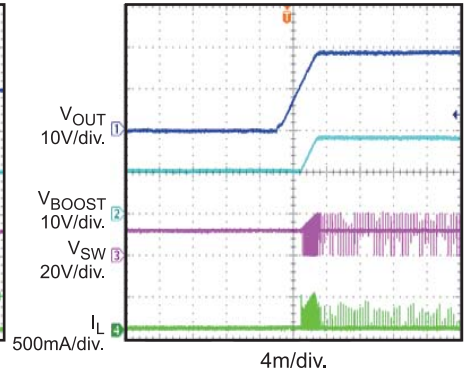
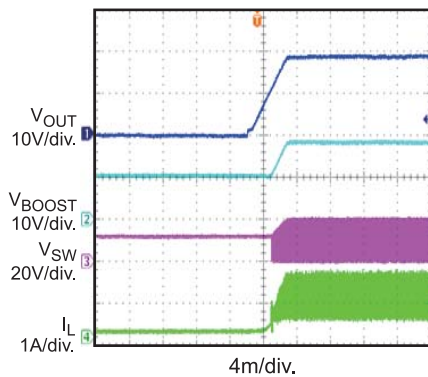
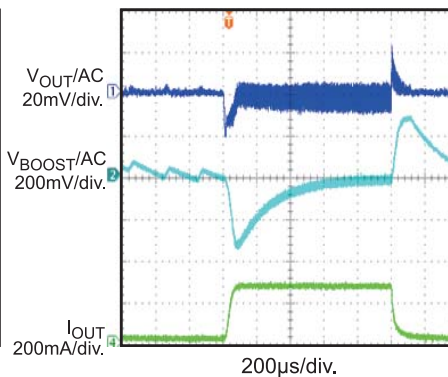
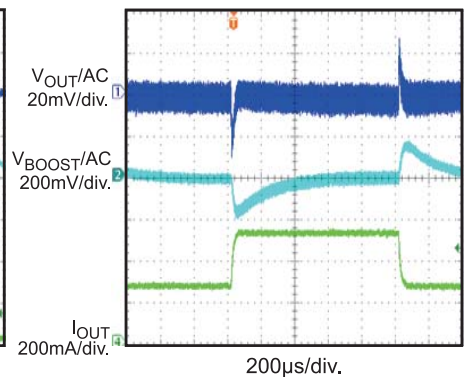
**SCP Entry**
 $I_{OUT} = 0.5A$  to Short

**SCP Steady State**
 $V_{OUT}$  Short

**SCP Recovery**
 $I_{OUT} =$  Short to 0A

**SCP Recovery**
 $I_{OUT} =$  Short to 0.5A

**Load Transient**
 $I_{OUT} = 0A$  to 0.25A

**Load Transient**
 $I_{OUT} = 0.25A$  to 0.5A

# PRINTED CIRCUIT BOARD LAYOUT

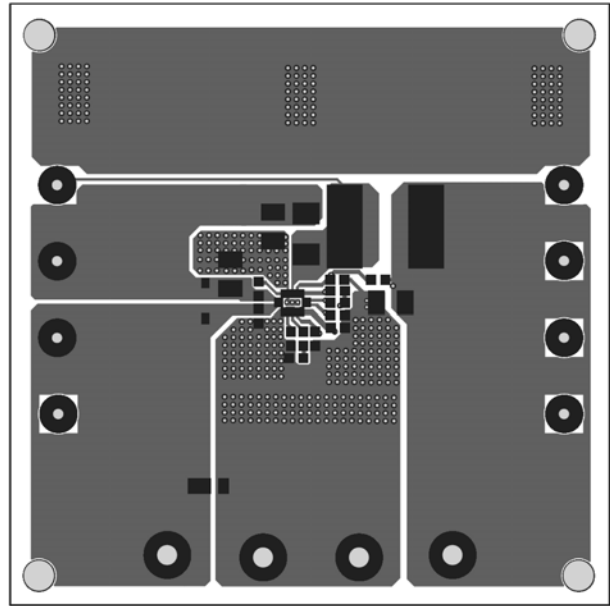
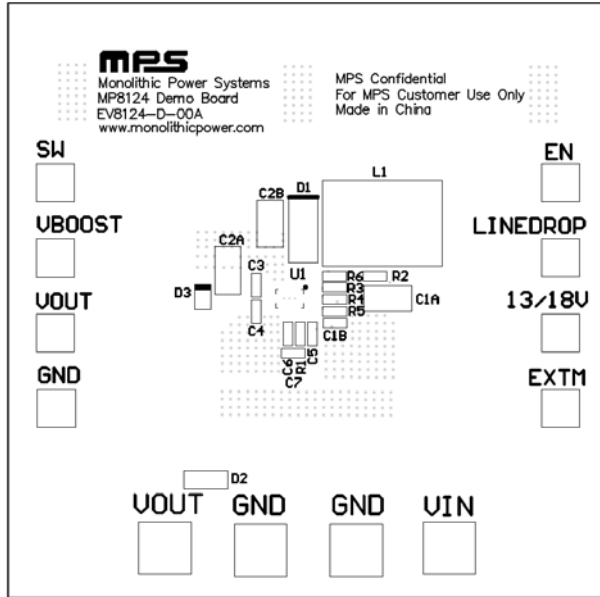

Figure 1—Top Silk Layer

Figure 2—Top Layer

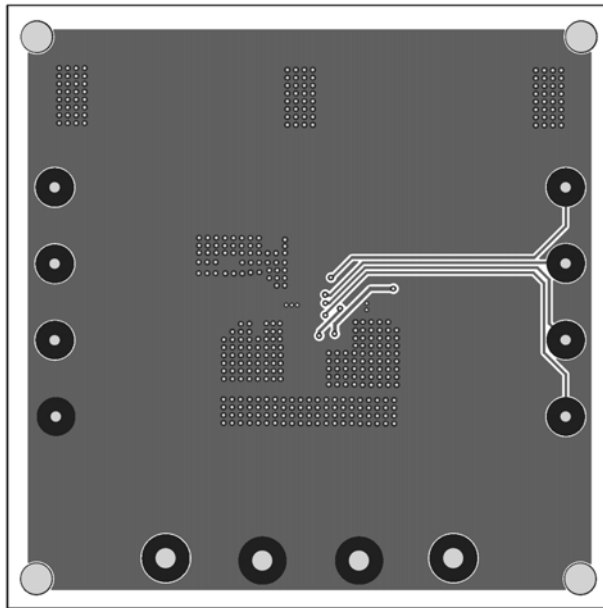

Figure 3—Bottom Layer



## QUICK START GUIDE

The output voltage of this board is set to 19V. The board layout accommodates most commonly used components.

1. Preset Power Supply to  $8V \leq V_{IN} \leq 14V$ .
2. Turn Power Supply off.
3. Connect Power Supply terminals to:
  - a. Positive (+): VIN
  - b. Negative (-): GND
4. Connect Load to:
  - a. Positive (+): VOUT
  - b. Negative (-): GND
5. Turn Power Supply on after making connections.
6. The MP8124 is enabled on the evaluation board once VIN power is turned on.
7. To use the Enable function, apply a logic high input to the EN pin. Set EN higher than 2V to turn on the regulator or lower than 0.8V to turn it off.
8. To generate tone signal on output, apply a logic signal with 22KHz frequency to the EXTM pin. The signal high level should be higher than 2V and the low level should be lower than 0.8V.
9. To adjust the output voltage, apply a logic input on 13V/18V pin or LINEDROP pin. The output voltage under different conditions is shown in below table. “High” represents a voltage higher than 2V, “Low” represents a voltage lower than 0.8V.

13/18V	LINEDROP	VOUT
High	High	19V
High	Low	18V
Low	High	14V
Low	Low	13V

10. The soft start time is adjusted by C6. For further information, please refer to MP8124 datasheet.

**NOTICE:** The information in this document is subject to change without notice. Please contact MPS for current specifications. Users should warrant and guarantee that third party Intellectual Property rights are not infringed upon when integrating MPS products into any application. MPS will not assume any legal responsibility for any said applications.