

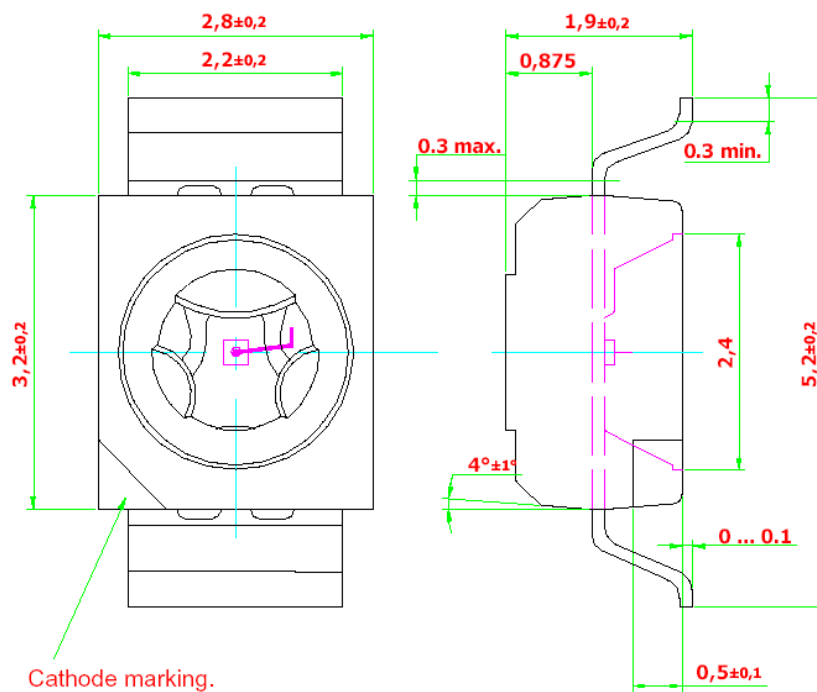

● Feature:

- 1. High brightness surface mount LED.
- 2. 120° viewing angle.
- 3. Small package outline (LxWxH) of 2.8 x 3.2 x 1.8 mm.
- 4. Qualified according to JEDEC moisture sensitivity Level 2.
- 5. Compatible to both IR reflow soldering and TTW soldering.

● Package Dimension:



Recommended Solder Pad

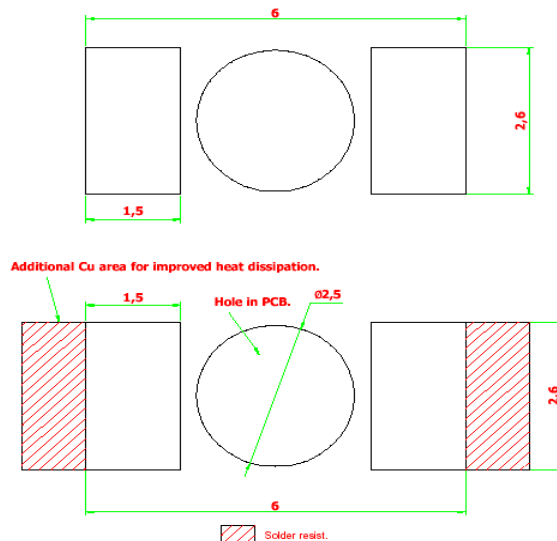



● Optical Characteristics:

Part Number	Chip Technology / Color	Viewing Angle °	Luminous Intensity @ IF=20mA Iv (mcd)
BL-PDH-CRS-C10 <ul style="list-style-type: none">• BIN P1• BIN P2• BIN Q1• BIN Q2	AllnGaP Hyper-red, 640nm	120	45.0 – 112.5 45.0 – 56.0 56.0 – 71.5 71.5 – 90.0 90.0 – 112.5
BL-PDS-CRS-C10 <ul style="list-style-type: none">• BIN Q1• BIN Q2• BIN R1• BIN R2 BL-PDS-SRS-C10 <ul style="list-style-type: none">• BIN Q1• BIN Q2• BIN R1• BIN R2	AllnGaP Super-red, 632nm	120	71.5 – 180.0 71.5 – 90.0 90.0 – 112.5 112.5 – 140.0 140.0 – 180.0 71.5 – 180.0 71.5 – 90.0 90.0 – 112.5 112.5 – 140.0 140.0 – 180.0
BL-PDR-CRS-C10 <ul style="list-style-type: none">• BIN R1• BIN R2• BIN S1• BIN S2 BL-PDR-SRS-C10 <ul style="list-style-type: none">• BIN R1• BIN R2• BIN S1• BIN S2	AllnGaP Red, 625nm	120	112.5 – 285.0 112.5 – 140.0 140.0 – 180.0 180.0 – 224.0 224.0 – 285.0 112.5 – 285.0 112.5 – 140.0 140.0 – 180.0 180.0 – 224.0 224.0 – 285.0
BL-PDR-TRS-C10 <ul style="list-style-type: none">• BIN T1• BIN T2• BIN U1• BIN U2	TS AllnGaP Red, 625nm	120	285.0 – 715.0 285.0 – 355.0 355.0 – 450.0 450.0 – 560.0 560.0 – 715.0
BL-PDA-CRS-C10 <ul style="list-style-type: none">• BIN R1• BIN R2• BIN S1• BIN S2 BL-PDA-SRS-C10 <ul style="list-style-type: none">• BIN S1• BIN S2• BIN T1• BIN T2	AllnGaP Amber, 615nm	120	112.5 – 285.0 112.5 – 140.0 140.0 – 180.0 180.0 – 224.0 224.0 – 285.0 180.0 – 450.0 180.0 – 224.0 224.0 – 285.0 285.0 – 355.0 355.0 – 450.0



Part Ordering Number	Chip Technology / Color	Viewing Angle	Luminous Intensity @ IF=20mA Iv (mcd)
BL-PDO-CRS-C10 <ul style="list-style-type: none"> • BIN R1 • BIN R2 • BIN S1 • BIN S2 	AllnGaP Orange, 605nm	120	112.5 – 285.0 112.5 – 140.0 140.0 – 180.0 180.0 – 224.0 224.0 – 285.0
BL-PDO-SRS-C10 <ul style="list-style-type: none"> • BIN S1 • BIN S2 • BIN T1 • BIN T2 			180.0 – 450.0 180.0 – 224.0 224.0 – 285.0 285.0 – 355.0 355.0 – 450.0
BL-PDY-CRS-C10 <ul style="list-style-type: none"> • BIN R1 • BIN R2 • BIN S1 • BIN S2 	AllnGaP Yellow, 587nm	120	112.5 – 285.0 112.5 – 140.0 140.0 – 180.0 180.0 – 224.0 224.0 – 285.0
BL-PDY-SRS-C10 <ul style="list-style-type: none"> • BIN S1 • BIN S2 • BIN T1 • BIN T2 			180.0 – 450.0 180.0 – 224.0 224.0 – 285.0 285.0 – 355.0 355.0 – 450.0
BL-PDY-TRS-C10 <ul style="list-style-type: none"> • BIN T1 • BIN T2 • BIN U1 • BIN U2 	TS AllnGaP Yellow, 590nm	120	285.0 – 715.0 285.0 – 355.0 355.0 – 450.0 450.0 – 560.0 560.0 – 715.0
BL-PDG-CRS-C10 <ul style="list-style-type: none"> • BIN P1 • BIN P2 • BIN Q1 • BIN Q2 	AllnGaP Green, 572nm	120	45.0 – 112.5 45.0 – 56.0 56.0 – 71.5 71.5 – 90.0 90.0 – 112.5
BL-PDG-SRS-C10 <ul style="list-style-type: none"> • BIN Q1 • BIN Q2 • BIN R1 • BIN R2 			71.5 – 180.0 71.5 – 90.0 90.0 – 112.5 112.5 – 140.0 140.0 – 180.0

NOTE:

1. Other luminous intensity groups are also available upon request.
2. Luminous intensity is measured with an accuracy of $\pm 11\%$.
3. Wavelength binning is carried for all units as per the wavelength-binning table. Only one wavelength group is allowed for each reel.
4. An optional Vf binning is also available upon request. Binning scheme is as per following table.



● **Absolute Maximum Ratings:**

Parameter	Maximum Value	Unit
DC forward current.	30	mA
Peak pulse current; ($t_p \leq 10 \mu\text{s}$, Duty cycle = 0.005)	1000	mA
Reverse voltage.	5	V
LED junction temperature.	125	°C
Operating temperature.	-40 ... +100	°C
Storage temperature.	-40 ... +100	°C
Power dissipation (at room temperature)	75	mW

● **Vf Binning:**

Vf Bin @ 20mA	Forward Voltage (V)
Standard	1.55 ... 2.45 (max)
01	1.55 ... 1.85
02	1.85 ... 2.15
03	2.15 ... 2.45
04	2.45 ... 2.75

Forward voltage, Vf is measured with an accuracy of ± 0.1 V.



● **Wavelength Grouping:**

Color	Group	Wavelength distribution (nm)
BL-PDH; Hyper-red	Full	636 - 646
BL-PDS; Super-red	Full	625 - 640
BL-PDR-CJ, -SJ; Red (AS)	Full	620 - 630
BL-PDR-TJ; Red (TS)	Full	620 - 635
BL-PDA; Amber	Full	610 - 621
	W	610 - 615
	X	615 - 621
BL-PDO; Orange	Full	600 - 612
	W	600 - 603
	X	603 - 606
	Y	606 - 609
	Z	609 - 612
BL-PDY; Yellow	Full	582 - 594
	W	582 - 585
	X	585 - 588
	Y	588 - 591
	Z	591 - 594
BL-PDG; Green	Full	564.5 - 576.5
	W	564.5 - 567.5
	X	567.5 - 570.5
	Y	570.5 - 573.5
	Z	573.5 - 576.5



● Typical electro-optical characteristics curves:

Fig. 1 Relative luminous intensity vs. forward current.

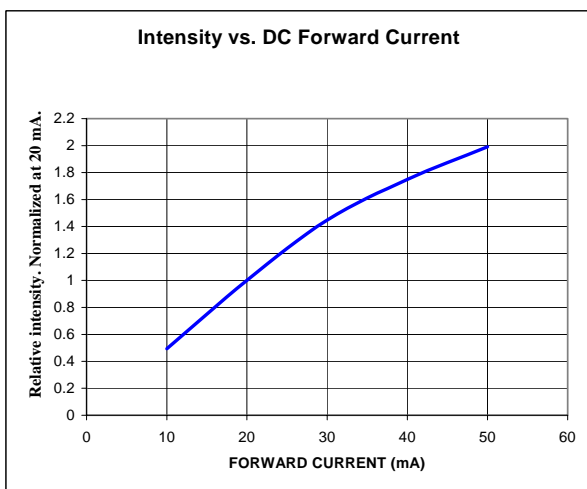

Fig. 2 Forward current vs. forward voltage.

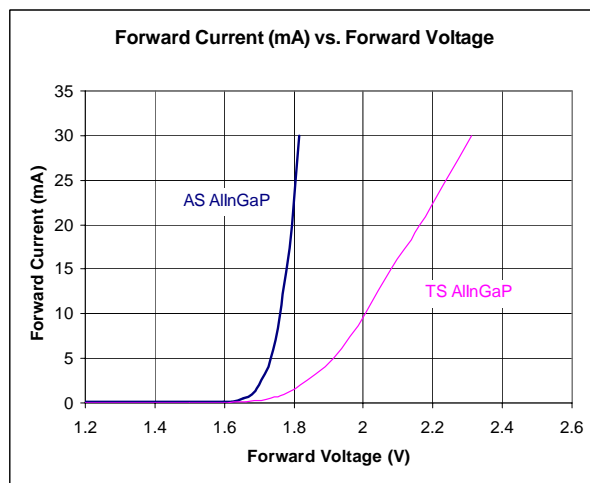

Fig. 3 Radiation pattern.

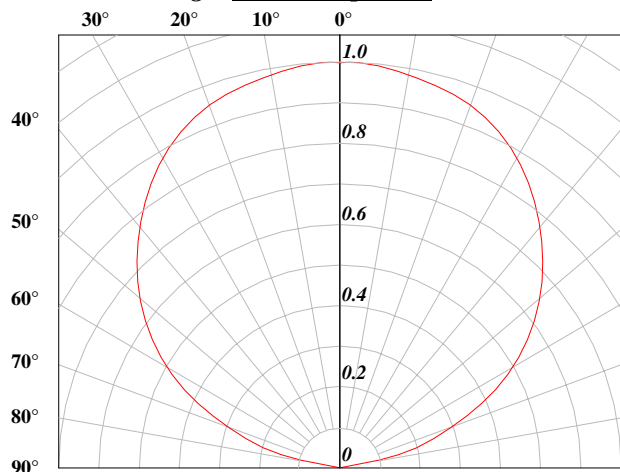

Fig. 4 Maximum forward current vs. temperature.

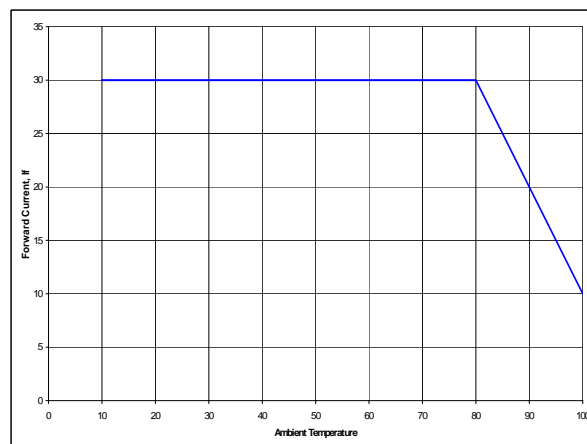

Fig. 5 Relative Intensity vs. Wavelength

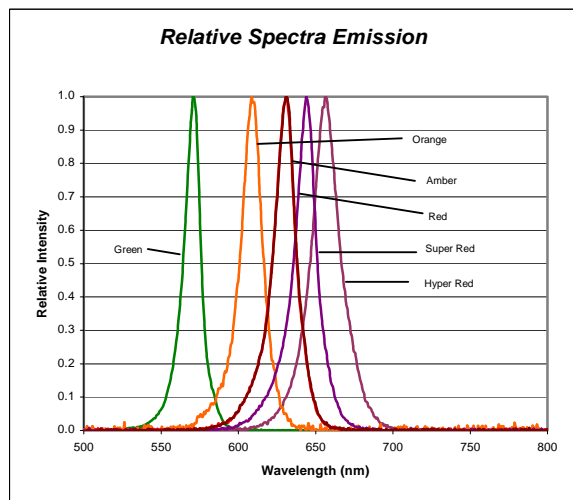



Fig. 6 Recommended IR-reflow Soldering Profile.

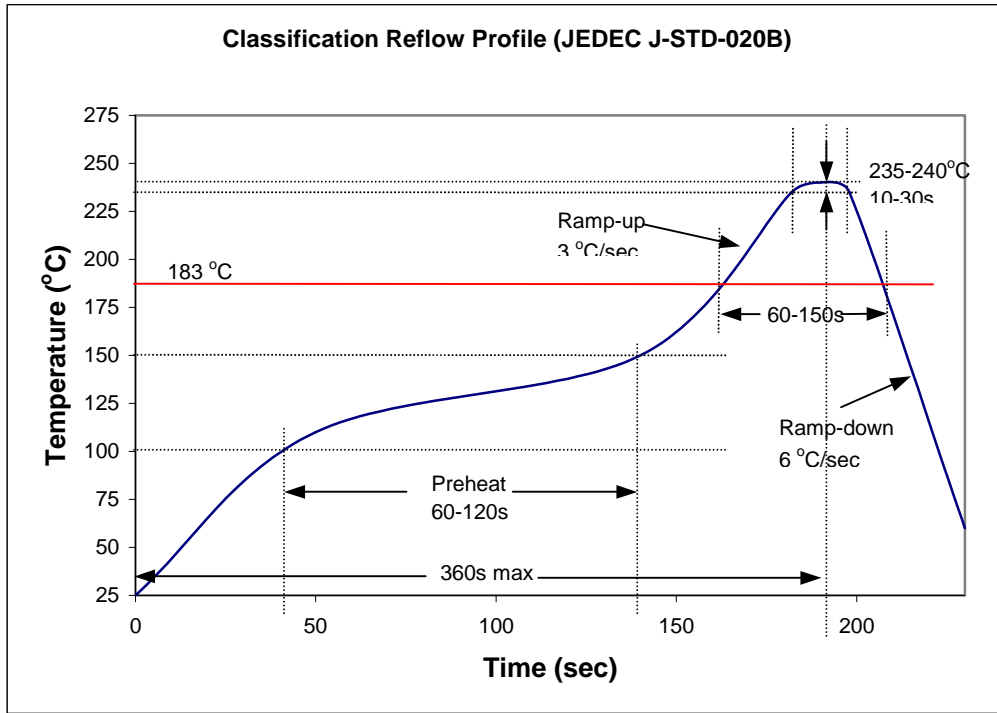
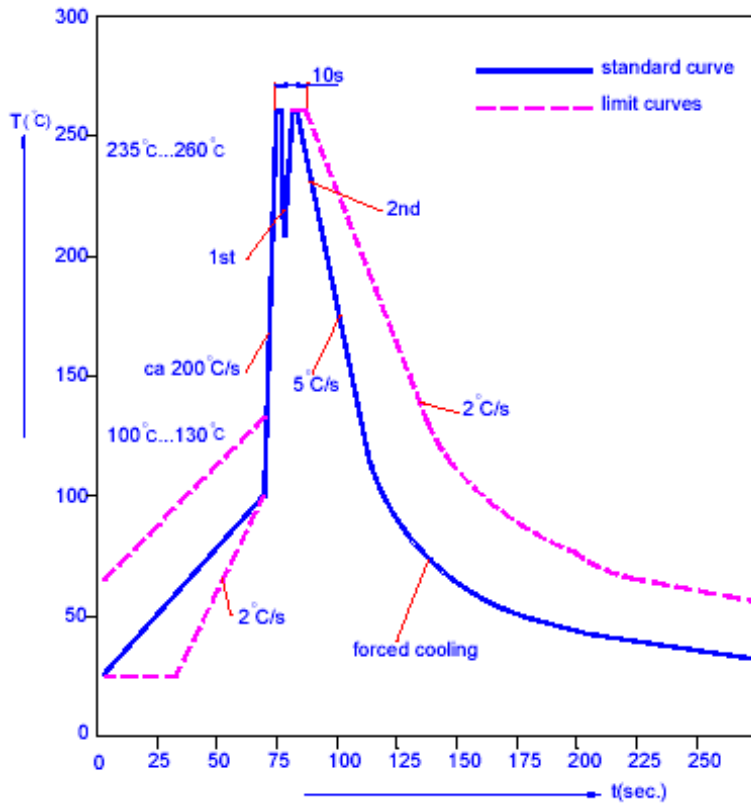

Fig. 7 Recommended TTW Soldering Profile.





● Taping And Orientation.

Reels come in quantity of 8000 units or 2000 units.

Reel diameters are 330 mm and 180 mm respectively.

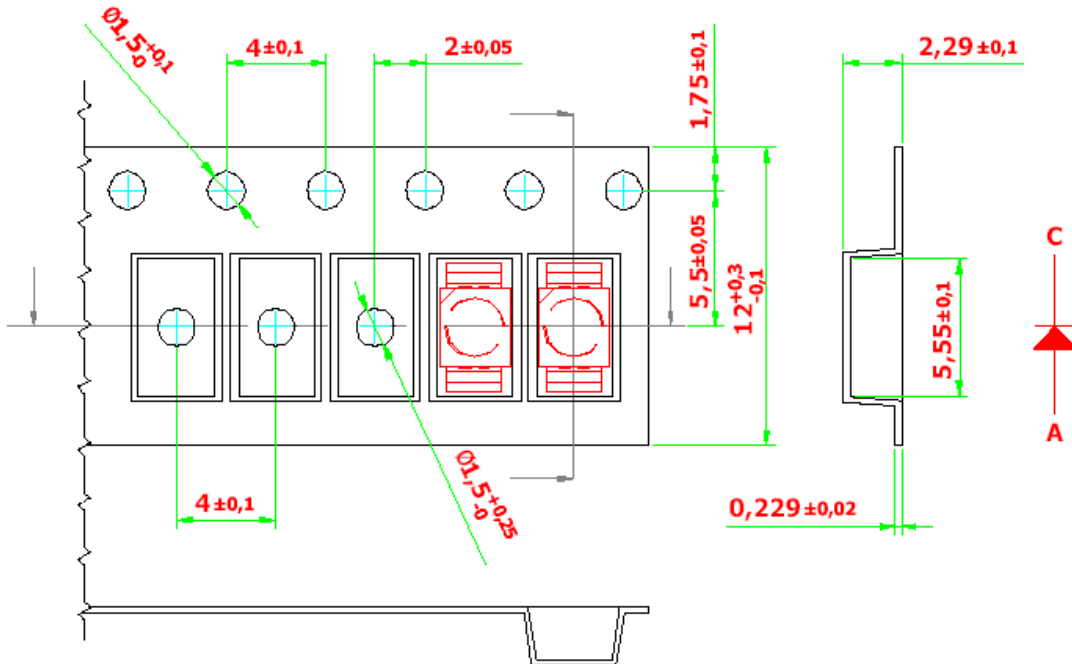

200 mm min. for $\varnothing 180$ reel.

480 mm min. for $\varnothing 180$ reel.

200 mm min. for $\varnothing 330$ reel.

960 mm min. for $\varnothing 330$ reel.

