



PCB Single O/P - 3.5"L x 2.5"W x 0.98"H,  
Multi O/P - 4.06"L x 2.5"W x 0.98"H  
Chassis 4.76"L x 2.56"W x 1.0"H

- Single / Dual / Triple Outputs
- Universal 85VAC to 265VAC Input
- 3.3VDC to 24VDC Outputs
- 4,000VAC Input to Output Isolation
- PCB and Chassis Mount Packages
- Full Safety Approvals



Fully Approved  
UL/CSA22.2 2601 File# E167432  
EN60601-1 File# B021022749041

Model Number	Output Voltage	Output Amps	Output Watts
<b>SINGLE OUTPUT - PCB Mount</b>			
MSMA-0300	3.3 VDC	7.5	25W
MSMA-0301	5 VDC	6	30W
MSMA-0302	12 VDC	2.5	30W
MSMA-0303	15 VDC	2	30W
MSMA-0305	24 VDC	1.25	30W
<b>SINGLE OUTPUT - Chassis Mount</b>			
MSMC-0300	3.3 VDC	7.5	25W
MSMC-0301	5 VDC	6	30W
MSMC-0302	12 VDC	2.5	30W
MSMC-0303	15 VDC	2	30W
MSMC-0305	24 VDC	1.25	30W
<b>SINGLE OUTPUT - DIN Rail Mount</b>			
MSMC-0300/DRL	3.3 VDC	7.5	25W
MSMC-0301/DRL	5 VDC	6	30W
MSMC-0302/DRL	12 VDC	2.5	30W
MSMC-0303/DRL	15 VDC	2	30W
MSMC-0305/DRL	24 VDC	1.25	30W



PCB Single O/P - 3.5"L x 2.5"W x 0.98"H,  
Multi O/P - 4.06"L x 2.5"W x 0.98"H  
Chassis 4.76"L x 2.56"W x 1.0"H

- Single / Dual / Triple Outputs
- Universal 85VAC to 265VAC Input
- 3.3VDC to 24VDC Outputs
- 4,000VAC Input to Output Isolation
- PCB and Chassis Mount Packages
- Full Safety Approvals



Fully Approved  
UL/CSA22.2 2601 File# E167432  
EN60601-1 File# B021022749041

Model Number	Output Voltage	Output Amps	Output Watts
<b>DUAL OUTPUT - PCB Mount</b>			
MDMA-0306	+/-12 VDC	+/-1.25	30W
MDMA-0307	+/-15 VDC	+/-1	30W
MDMA-0308	+5/12 VDC	3/1.25	30W
<b>DUAL OUTPUT - Chassis Mount</b>			
MDCM-0306	+/-12 VDC	+/-1.25	30W
MDCM-0307	+/-15 VDC	+/-1	30W
MDCM-0308	+5/12 VDC	3/1.25	30W
<b>DUAL OUTPUT - DIN Rail Mount</b>			
MDCM-0306/DRL	+/-12 VDC	+/-1.25	30W
MDCM-0307/DRL	+/-15 VDC	+/-1	30W
MDCM-0308/DRL	+5/12 VDC	3/1.25	30W
<b>TRIPLE OUTPUT - PCB Mount</b>			
MTMA-0309	+5,+/-12 VDC	3,0.63/0.63	30W
MTMA-0311	+5,+/-15 VDC	3,0.5/0.5	30W
<b>TRIPLE OUTPUT - Chassis Mount</b>			
MTMC-0309	+5,+/-12 VDC	3,0.63/0.63	30W
MTMC-0311	+5,+/-15 VDC	3,0.5/0.5	30W
<b>TRIPLE OUTPUT - DIN Rail Mount</b>			
MTMC-0309/DRL	+5,+/-12 VDC	3,0.63/0.63	30W
MTMC-0311/DRL	+5,+/-15 VDC	3,0.5/0.5	30W

### INPUT SPECIFICATIONS

Input Voltage, Nominal	85-265VAC
	Nominal: 100-240VAC
Input Frequency	47-440 Hz, 50-60Hz Nom.
Inrush Current	20A @ 100VAC, typ
	40A @ 200VAC, typ

### OUTPUT SPECIFICATIONS

Output Voltage/Current	See Specific Model
Initial Accuracy	+/-1%, adjustable
Voltage Adjust	+/-6%, typ
Load Regulation	+/-0.3%, typ
Line Regulation	+/-0.3%, typ
Temperature Coefficient	+/-0.03%/°C
Ripple/Noise(20Mhz BW)	150mV Pk-Pk, typ
Overvoltage Protection	Clamp, 130-150% *
Hold Up Time	30mS, typ
Short Circuit Protection	Continuous, self-recovering *
Current Limit	130% typ, Self-Reset Foldback

### PERFORMANCE CURVES

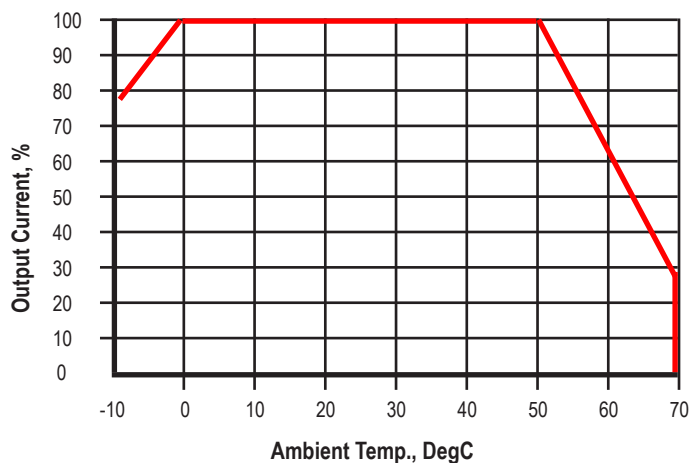

All specifications are typical at nominal input, full load, and 25DegC unless otherwise noted

\* These are stress ratings. Exposure of the devices to any of these conditions may adversely affect long term reliability. Proper operation under conditions other than the standard operating conditions is neither warranted nor implied.

### GENERAL SPECIFICATIONS

On/Off Control	Open Collector
	Logic "1"/Open=ON
	Logic "0"/GND=OFF
Input-Out Isolation	4000VAC
Output-Ground Isolation	1000VAC
Input-Ground Isolation	2500VAC
Operating Frequency	140 Khz, fixed
Efficiency (@ Full Load)	75 - 80%, typ

### ENVIRONMENTAL SPECIFICATIONS

Oper. Temperature	0 to +50°C FL See Derate *
	(Free-air Convection)
Relative Humidity	0-95%, Non-Condensing
Storage Temperature	-25 to +71°C *
MTBF, Single/Multi Output	180,000 Hrs/110,000 Hrs
	Mil Std 217, 25C

### PHYSICAL SPECIFICATIONS

Case Material	Rynite, 94V-0 Rated
Construction	Encapsulated, Soft Pot
Weight	PCB / CHA
	Singles 10.4 oz (292g) / 13.4 oz (376g)
	Duals/Triples 12.1 oz (340g) / 15.4 oz (430g)

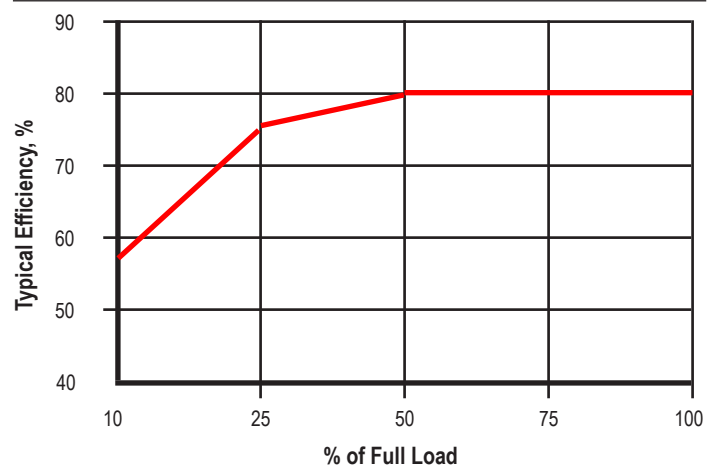

**Astrodyne products are not authorized or warranted for use as critical components in life support systems, equipment used in hazardous environments, nuclear controls systems, or other mission-critical applications.**

### MECHANICAL DIMENSIONS - PCB MOUNT

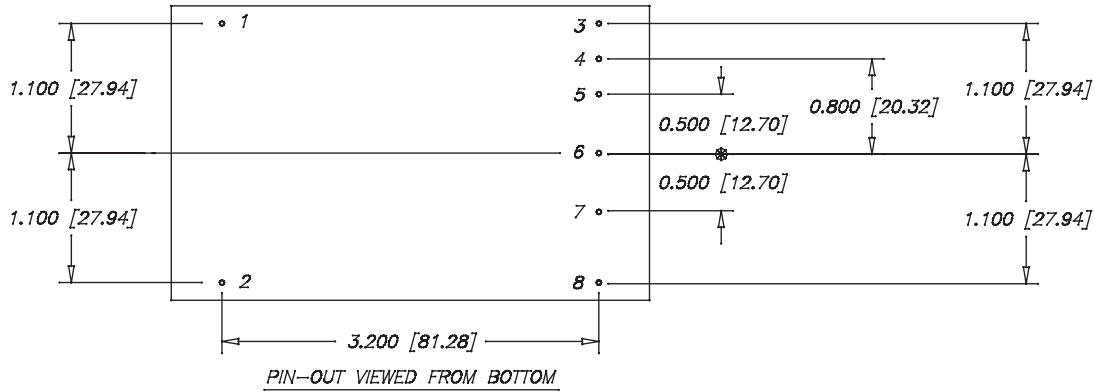

### SINGLE OUTPUT

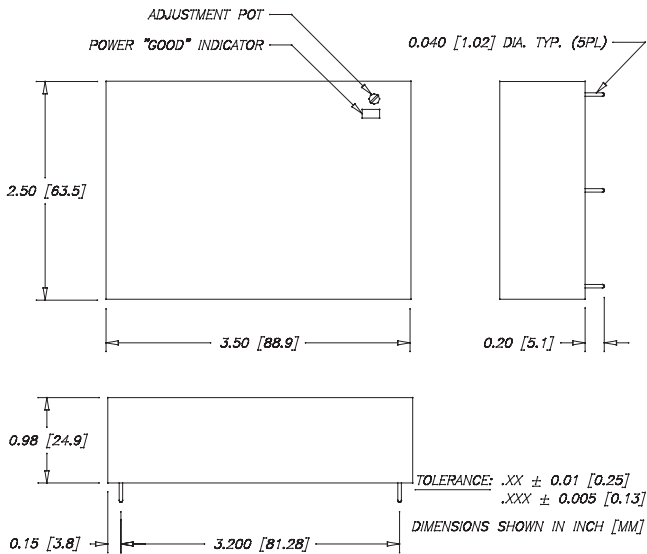

### DUAL/TRIPLE OUTPUT

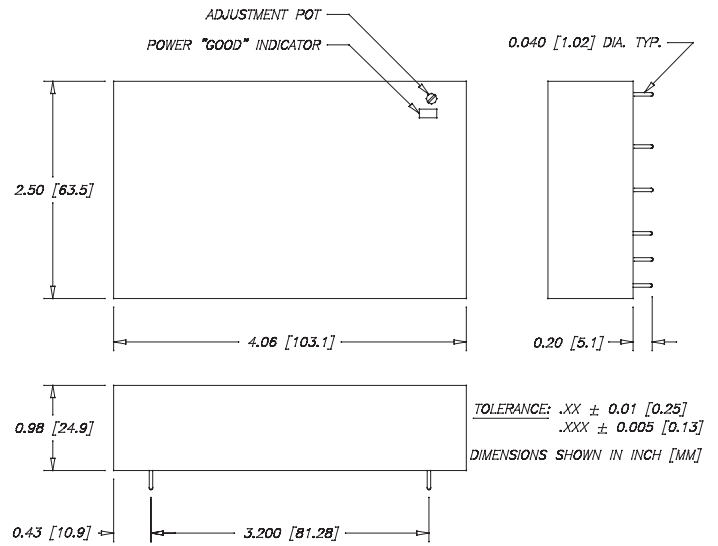

Model Type / Pin#	Single	Dual Matched	Dual 5/12V	Triple
1	AC HI	AC HI	AC HI	AC HI
2	AC LO	AC LO	AC LO	AC LO
3	Ctrl	-Vout	Com	-Vout
4	No Pin	Ctrl	Ctrl	Ctrl
5	No Pin	No Pin	No Pin	+5 Ret
6	-Vout	Com	+5out	+/-Com
7	No Pin	No Pin	No Pin	+5Vout
8	+Vout	+Vout	+12Vout	+Vout

### MECHANICAL DIMENSIONS - CHASSIS MOUNT

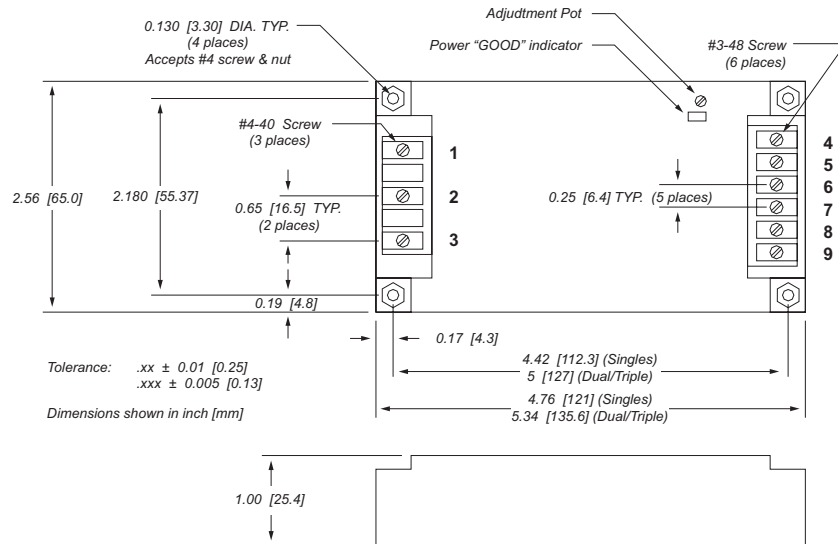

### MECHANICAL DIMENSIONS - DIN RAIL

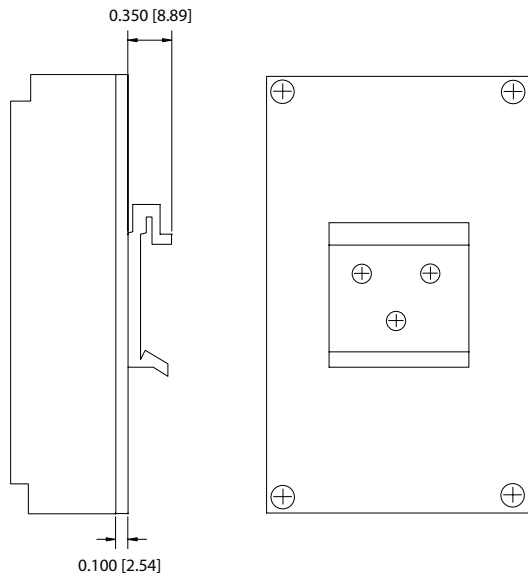

Model Type / Pin#	Single	Match Dual	Unmatch Dual	Triple
1	AC LO	AC LO	AC LO	AC LO
2	GND	GND	GND	GND
3	AC HI	AC HI	AC HI	AC HI
4	+Vout	+Vout	+12Vout	+Vout
5	+Vout	Com	+5Vout	+5Vout
6	-Vout	Com	+5Vout	+/- Com
7	-Vout	-Vout	Com	+5V Ret
8	N/C	N/C	Com	-Vout
9	Ctrl	Ctrl	Ctrl	Ctrl

DIN Rail mounting kit available for Chassis-mount modules.  
 - For 30 watt single outputs specify part # M-DRL-30S  
 - For 30 watt dual/single outputs specify part # M-DRL-30T  
 Kit includes mounting plate, DIN Rail cliip and assembly hardware.