

# AMMC-5024

## 30 KHz – 40 GHz Traveling Wave Amplifier

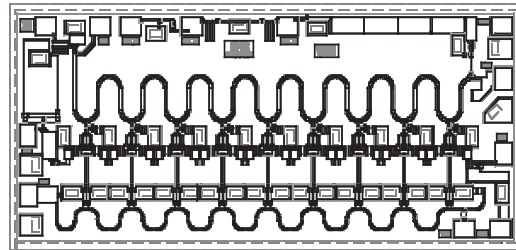

### Data Sheet



**Chip Size:** 2350 x 1050  $\mu\text{m}$  (92.5 x 41.3 mils)  
**Chip Size Tolerance:**  $\pm 10 \mu\text{m}$  ( $\pm 0.4$  mils)  
**Chip Thickness:**  $100 \pm 10 \mu\text{m}$  ( $4 \pm 0.4$  mils)  
**Pad Dimensions:**  $80 \times 80 \mu\text{m}$  ( $2.95 \pm 0.4$  mils)

### Description

Avago Technologies' AMMC-5024 is a broadband PHEMT GaAs MMIC TWA designed for medium output power and high gain over the full 30 KHz to 40 GHz frequency range. The design employs a 9-stage, cascade-connected FET structure to ensure flat gain and power as well as uniform group delay. E-beam lithography is used to produce uniform gate lengths of  $0.15 \mu\text{m}$  and MBE technology assures precise semiconductor layer control. For improved reliability and moisture protection, the die is passivated at the active areas.

### Features

- Wide frequency range: 30 KHz – 40 GHz
- High gain: 16 dB
- Gain flatness:  $\pm 0.75$  dB
- Return loss:  
Input: 13 dB, Output: 13 dB
- Medium power: P-1dB = 22.5 dBm at 22 GHz
- Low noise figure: 4.6 dB at 26 GHz

### Applications

- Communication systems
- Microwave instrumentation
- Optical systems
- Broadband applications requiring flat gain and group delay with excellent input and output port matches over the 30 KHz and 40 GHz frequency range

### Absolute Maximum Ratings<sup>[1]</sup>

| Symbol    | Parameters/Conditions           | Units              | Min. | Max. |
|-----------|---------------------------------|--------------------|------|------|
| $V_{dd}$  | Positive Drain Voltage          | V                  |      | 10   |
| $I_{dd}$  | Total Drain Current             | mA                 |      | 340  |
| $V_{g1}$  | First Gate Voltage              | V                  | -9.5 | 0    |
| $I_{g1}$  | First Gate Current              | mA                 | -38  | +1   |
| $V_{g2}$  | Second Gate Voltage             | V                  | -3.5 | +4   |
| $I_{g2}$  | Second Gate Current             | mA                 | -20  |      |
| $P_{in}$  | CW Input Power                  | dBm                |      | 17   |
| $T_{ch}$  | Operating Channel Temperature   | $^{\circ}\text{C}$ |      | +150 |
| $T_b$     | Operating Backside Temperature  | $^{\circ}\text{C}$ | -55  |      |
| $T_{stg}$ | Storage Temperature             | $^{\circ}\text{C}$ | -65  | +165 |
| $T_{max}$ | Max. Assembly Temp (60 sec max) | $^{\circ}\text{C}$ |      | +300 |

Notes:

1. Absolute maximum ratings for continuous operation unless otherwise noted.

## AMMC-5024 DC Specifications/Physical Properties <sup>[1]</sup>

| Symbol                      | Parameters and Test Conditions  | Units                     | Min. | Typ. | Max. |
|-----------------------------|---|---------------------------|------|------|------|
| $I_{dss}$                   | Saturated Drain Current ( $V_{dd}=7\text{ V}$ , $V_{g1}=0\text{ V}$ , $V_{g2}=\text{open circuit}$ )              | mA                        | 265  | 350  | 385  |
| $V_p$                       | First Gate Pinch-off Voltage ( $V_{dd}=7\text{ V}$ , $I_{dd}=30\text{ mA}$ , $V_{g2}=\text{open circuit}$ )       | V                         |      | -8.2 |      |
| $V_{g2}$                    | Second Gate Self-bias Voltage ( $V_{dd}=7\text{ V}$ , $I_{dd}=200\text{ mA}$ , $V_{g2}=\text{open circuit}$ )     | V                         |      | 2.75 |      |
| $I_{dsmin}$<br>( $V_{g1}$ ) | First Gate Minimum Drain Current<br>( $V_{dd}=7\text{ V}$ , $V_{g1}=-7\text{ V}$ , $V_{g2}=\text{open circuit}$ ) | mA                        |      | 47   |      |
| $I_{dsmin}$<br>( $V_{g2}$ ) | Second Gate Minimum Drain Current<br>( $V_{dd}=7\text{ V}$ , $V_{g1}=0\text{ V}$ , $V_{g2}=-3.5\text{ V}$ )       | mA                        |      | 105  |      |
| $\theta_{ch-b}$             | Thermal Resistance <sup>[2]</sup> (Backside temperature, $T_b = 25^\circ\text{C}$ )                               | $^\circ\text{C}/\text{W}$ |      | 16.2 |      |

## RF Specifications for High Power Applications <sup>[2, 3]</sup> ( $V_{dd}=7\text{ V}$ , $I_{dd}(Q)=200\text{ mA}$ , $Z_{in}=Z_o=50\Omega$ )

| Symbol             | Parameters and Test Conditions  | Units                                | Min. | Typ.       | Max.     |
|--------------------|---|--------------------------------------|------|------------|----------|
| $ S_{21} ^2$       | Small-signal Gain   | dB                                   | 14   | 16         | 18       |
| $\Delta S_{21} ^2$ | Small-signal Gain Flatness  | dB                                   |      | $\pm 0.75$ | $\pm 2$  |
| $RL_{in}$          | Input Return Loss   | dB                                   | 12   | 16.9       |          |
| $RL_{out}$         | Output Return Loss  | dB                                   | 10   | 16.8       |          |
| $ S_{12} ^2$       | Isolation   | dB                                   | 26   | 28         |          |
| $P_{-1dB}$         | Output Power @ 1 dB Gain Compression  | f = 22 GHz<br>dBm                    | 21   | 22.5       |          |
| $P_{sat}$          | Saturated Output Power  | f = 22 GHz<br>dBm                    | 23   | 24.5       |          |
| OIP3               | Output 3 <sup>rd</sup> Order Intercept Point,<br>$Rf_{in1} = Rf_{in2} = 2\text{ dBm}$ , f = 22 GHz, $\Delta f = 2\text{ MHz}$ | dBm                                  | 27   | 30         |          |
| NF                 | Noise Figure ( $V_{ds} = 3\text{ V}$ , $I_{ds} = 140\text{ mA}$ )   | f = 26 GHz<br>dB<br>f = 40 GHz<br>dB |      | 4.6<br>7.2 | 6.5<br>9 |

## RF Specifications for High Gain and Low Power Applications <sup>[2, 3]</sup> ( $V_{dd}=4\text{ V}$ , $I_{dd}(Q)=160\text{ mA}$ , $Z_{in}=Z_o=50\Omega$ )

| Symbol             | Parameters and Test Conditions  | Units                                | Min. | Typ.       | Max. |
|--------------------|---|--------------------------------------|------|------------|------|
| $ S_{21} ^2$       | Small-signal Gain   | dB                                   |      | 17.5       |      |
| $\Delta S_{21} ^2$ | Small-signal Gain Flatness  | dB                                   |      | $\pm 1.5$  |      |
| $RL_{in}$          | Minimum Input Return Loss   | dB                                   |      | 13         |      |
| $RL_{out}$         | Minimum Output Return Loss  | dB                                   |      | 13         |      |
| $ S_{12} ^2$       | Isolation   | dB                                   |      | 30         |      |
| $P_{-1dB}$         | Output Power @ 1 dB Gain Compression  | f = 22 GHz<br>dBm                    |      | 17.3       |      |
| $P_{sat}$          | Saturated Output Power  | f = 22 GHz<br>dBm                    |      | 20.5       |      |
| OIP3               | Output 3 <sup>rd</sup> Order Intercept Point,<br>$Rf_{in1} = Rf_{in2} = 2\text{ dBm}$ , f = 22 GHz, $\Delta f = 2\text{ MHz}$ | dBm                                  |      | 22.5       |      |
| NF                 | Noise Figure  | f = 26 GHz<br>dB<br>f = 40 GHz<br>dB |      | 3.7<br>5.5 |      |

### Notes:

1. Backside temperature  $T_b = 25^\circ\text{C}$  unless otherwise noted.
2. Channel to board Thermal Resistance is measured using QFI method.
3. 100% on-wafer RF test is done at frequency = 2, 10, 20, 30 and 40 GHz, except as noted.

**AMMC-5024 Typical Performance ( $T_{\text{chuck}} = 25^{\circ}\text{C}$ ,  $V_{\text{dd}} = 7\text{V}$ ,  $I_{\text{dd}} = 200\text{mA}$ ,  $V_{\text{g2}} = \text{Open}$ ,  $Z_0 = 50\Omega$ )**

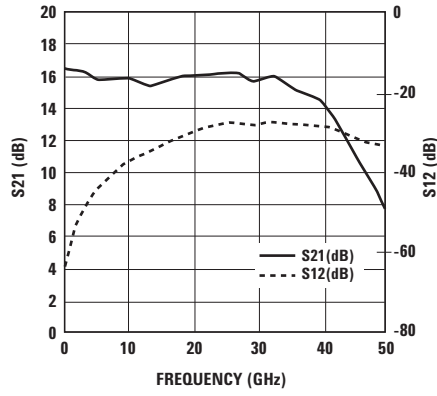

Figure 1. Gain and Reverse Isolation.

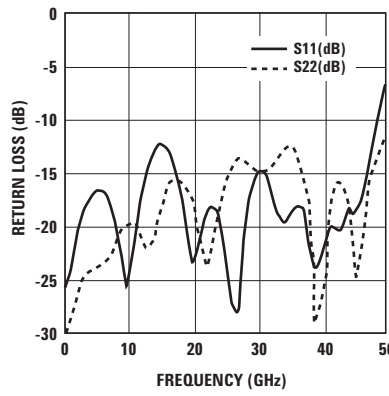

Figure 2. Return Loss (Input and Output).

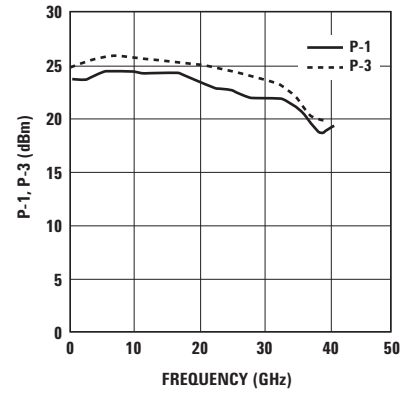

Figure 3. Output Power (P-1 and P-3).

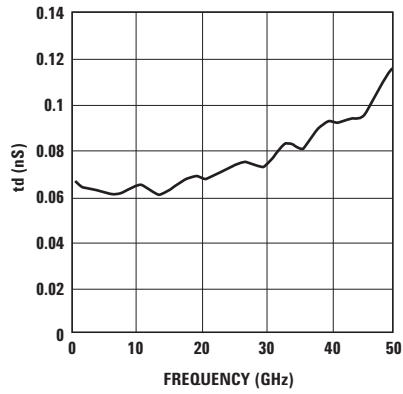

Figure 4. Group Delay.

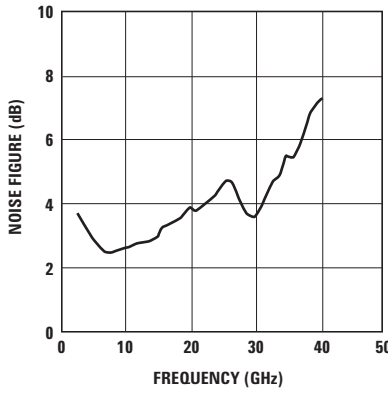

Figure 5. Noise Figure.

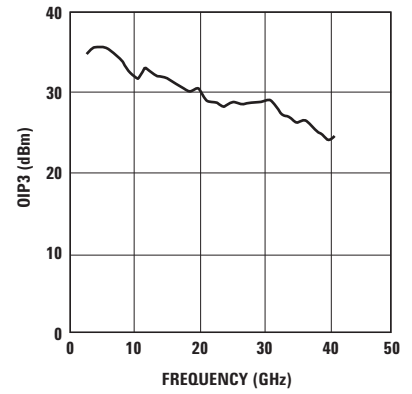

Figure 6. Output IP3.

**AMMC-5024 Typical Scattering Parameters<sup>[1]</sup> ( $T_{\text{chuck}} = 25^{\circ}\text{C}$ ,  $V_{\text{DD}} = 7\text{V}$ ,  $I_{\text{DD}} = 200\text{ mA}$ ,  $Z_{\text{in}} = Z_{\text{out}} = 50\Omega$ )**

| Freq.<br>GHz | $S_{11}$ |       |          | $S_{21}$ |       |          | $S_{12}$ |       |          | $S_{22}$ |       |          |
|--------------|----------|-------|----------|----------|-------|----------|----------|-------|----------|----------|-------|----------|
|              | dB       | Mag   | Phase    | dB       | Mag   | Phase    | dB       | Mag   | Phase    | dB       | Mag   | Phase    |
| 0.05         | -26.524  | 0.047 | -174.370 | 16.526   | 6.703 | 179.390  | -66.134  | 0.000 | -56.514  | -29.620  | 0.033 | 7.766    |
| 1            | -24.941  | 0.057 | -154.440 | 16.375   | 6.588 | 155.660  | -61.862  | 0.001 | -109.670 | -29.934  | 0.032 | 12.796   |
| 2            | -21.885  | 0.080 | -146.320 | 16.277   | 6.514 | 133.110  | -55.350  | 0.002 | -132.750 | -26.919  | 0.045 | 18.718   |
| 3            | -19.412  | 0.107 | -149.270 | 16.170   | 6.434 | 110.580  | -51.048  | 0.003 | -153.970 | -25.153  | 0.055 | 10.362   |
| 4            | -17.725  | 0.130 | -157.970 | 16.016   | 6.321 | 88.271   | -48.620  | 0.004 | -174.570 | -24.391  | 0.060 | 0.922    |
| 5            | -16.970  | 0.142 | -168.560 | 15.868   | 6.214 | 66.412   | -46.356  | 0.005 | 165.210  | -24.068  | 0.063 | -7.610   |
| 6            | -16.940  | 0.142 | -179.420 | 15.731   | 6.117 | 44.780   | -44.560  | 0.006 | 144.510  | -23.775  | 0.065 | -12.684  |
| 7            | -17.741  | 0.130 | 170.600  | 15.646   | 6.058 | 23.511   | -42.719  | 0.007 | 123.530  | -22.940  | 0.071 | -18.420  |
| 8            | -19.505  | 0.106 | 163.170  | 15.636   | 6.051 | 2.105    | -41.197  | 0.009 | 102.140  | -21.619  | 0.083 | -28.987  |
| 9            | -22.752  | 0.073 | 163.190  | 15.679   | 6.081 | -19.628  | -39.902  | 0.010 | 80.129   | -20.245  | 0.097 | -47.192  |
| 10           | -25.795  | 0.051 | -165.530 | 15.733   | 6.119 | -42.046  | -38.851  | 0.011 | 58.121   | -19.716  | 0.103 | -73.520  |
| 11           | -21.613  | 0.083 | -134.230 | 15.705   | 6.099 | -64.823  | -37.914  | 0.013 | 36.356   | -20.130  | 0.099 | -109.900 |
| 12           | -17.435  | 0.134 | -136.040 | 15.558   | 5.997 | -87.590  | -37.130  | 0.014 | 15.803   | -21.644  | 0.083 | -157.830 |
| 13           | -14.804  | 0.182 | -147.840 | 15.381   | 5.876 | -109.420 | -36.350  | 0.015 | -4.845   | -22.284  | 0.077 | 137.330  |
| 14           | -13.213  | 0.218 | -163.030 | 15.307   | 5.826 | -130.680 | -35.589  | 0.017 | -25.521  | -20.256  | 0.097 | 76.041   |
| 15           | -12.628  | 0.234 | -179.470 | 15.351   | 5.855 | -152.100 | -34.692  | 0.018 | -45.793  | -18.092  | 0.125 | 29.951   |
| 16           | -12.989  | 0.224 | 163.010  | 15.496   | 5.954 | -174.100 | -33.794  | 0.020 | -67.515  | -16.431  | 0.151 | -7.571   |
| 17           | -14.171  | 0.196 | 147.400  | 15.663   | 6.070 | 163.120  | -32.937  | 0.023 | -90.266  | -15.737  | 0.163 | -40.792  |
| 18           | -16.678  | 0.147 | 135.040  | 15.812   | 6.174 | 139.670  | -32.208  | 0.025 | -113.940 | -15.813  | 0.162 | -74.475  |
| 19           | -20.641  | 0.093 | 130.070  | 15.870   | 6.216 | 115.610  | -31.690  | 0.026 | -137.810 | -16.780  | 0.145 | -106.600 |
| 20           | -23.782  | 0.065 | 154.470  | 15.863   | 6.211 | 91.770   | -31.208  | 0.028 | -161.750 | -18.810  | 0.115 | -142.950 |
| 21           | -21.425  | 0.085 | 177.240  | 15.823   | 6.182 | 67.954   | -30.781  | 0.029 | 174.640  | -21.397  | 0.085 | 169.440  |
| 22           | -19.193  | 0.110 | 173.670  | 15.856   | 6.206 | 44.285   | -30.231  | 0.031 | 151.020  | -23.661  | 0.066 | 104.260  |
| 23           | -18.288  | 0.122 | 156.910  | 15.922   | 6.253 | 20.329   | -29.783  | 0.032 | 126.440  | -21.101  | 0.088 | 34.057   |
| 24           | -19.046  | 0.112 | 138.050  | 16.022   | 6.326 | -4.276   | -29.336  | 0.034 | 100.950  | -18.085  | 0.125 | -13.560  |
| 25           | -21.832  | 0.081 | 114.120  | 16.122   | 6.399 | -29.641  | -28.991  | 0.036 | 75.101   | -15.617  | 0.166 | -54.765  |
| 26           | -27.570  | 0.042 | 67.164   | 16.137   | 6.410 | -55.651  | -28.757  | 0.036 | 47.960   | -14.258  | 0.194 | -92.329  |
| 27           | -28.076  | 0.039 | -50.074  | 16.057   | 6.351 | -82.011  | -28.622  | 0.037 | 20.890   | -13.705  | 0.206 | -131.060 |
| 28           | -20.068  | 0.099 | -96.000  | 15.869   | 6.215 | -108.060 | -28.763  | 0.036 | -6.265   | -13.717  | 0.206 | -171.110 |
| 29           | -16.785  | 0.145 | -121.770 | 15.675   | 6.078 | -133.780 | -28.808  | 0.036 | -33.072  | -14.430  | 0.190 | 145.610  |
| 30           | -15.212  | 0.174 | -145.820 | 15.567   | 6.003 | -158.990 | -28.853  | 0.036 | -59.523  | -15.005  | 0.178 | 97.895   |
| 31           | -14.889  | 0.180 | -168.310 | 15.661   | 6.068 | 175.180  | -28.759  | 0.036 | -86.846  | -15.146  | 0.175 | 46.328   |
| 32           | -16.789  | 0.145 | 173.110  | 15.788   | 6.158 | 147.730  | -28.591  | 0.037 | -115.960 | -14.682  | 0.184 | -10.820  |
| 33           | -18.936  | 0.113 | 166.700  | 15.810   | 6.173 | 118.780  | -28.536  | 0.037 | -146.370 | -13.588  | 0.209 | -62.908  |
| 34           | -19.985  | 0.100 | 177.880  | 15.612   | 6.034 | 89.206   | -28.676  | 0.037 | -177.890 | -12.883  | 0.227 | -111.430 |
| 35           | -19.130  | 0.111 | 179.680  | 15.269   | 5.800 | 60.446   | -28.992  | 0.036 | 151.190  | -12.719  | 0.231 | -155.460 |
| 36           | -18.210  | 0.123 | 160.620  | 15.025   | 5.640 | 32.215   | -29.214  | 0.035 | 120.660  | -13.861  | 0.203 | 164.720  |
| 37           | -18.457  | 0.119 | 134.410  | 14.926   | 5.576 | 3.374    | -29.344  | 0.034 | 90.933   | -15.387  | 0.170 | 122.630  |
| 38           | -22.391  | 0.076 | 91.975   | 14.869   | 5.539 | -27.424  | -29.287  | 0.034 | 60.092   | -19.170  | 0.110 | 84.484   |
| 39           | -24.387  | 0.060 | 23.468   | 14.636   | 5.393 | -59.455  | -29.189  | 0.035 | 27.357   | -30.763  | 0.029 | 20.516   |
| 40           | -22.649  | 0.074 | -37.468  | 14.174   | 5.113 | -92.328  | -29.513  | 0.033 | -6.508   | -24.452  | 0.060 | -146.250 |
| 41           | -20.369  | 0.096 | -74.314  | 13.581   | 4.776 | -124.820 | -29.849  | 0.032 | -39.965  | -17.619  | 0.132 | 165.520  |
| 42           | -20.473  | 0.095 | -84.567  | 12.946   | 4.439 | -157.360 | -30.351  | 0.030 | -73.488  | -16.143  | 0.156 | 133.010  |
| 43           | -20.560  | 0.094 | -91.634  | 12.305   | 4.123 | 169.650  | -30.858  | 0.029 | -107.270 | -16.259  | 0.154 | 99.260   |
| 44           | -18.778  | 0.115 | -92.252  | 11.524   | 3.769 | 136.220  | -31.563  | 0.026 | -142.290 | -18.606  | 0.117 | 76.664   |
| 45           | -19.072  | 0.111 | -85.034  | 10.748   | 3.447 | 103.130  | -32.440  | 0.024 | -175.820 | -24.603  | 0.059 | 93.515   |
| 46           | -18.104  | 0.124 | -73.258  | 10.059   | 3.184 | 69.590   | -33.098  | 0.022 | 150.230  | -21.717  | 0.082 | 135.190  |
| 47           | -14.701  | 0.184 | -64.708  | 9.479    | 2.978 | 34.467   | -33.500  | 0.021 | 119.650  | -15.939  | 0.160 | 122.900  |
| 48           | -11.446  | 0.268 | -65.771  | 8.863    | 2.774 | -3.117   | -33.995  | 0.020 | 83.945   | -13.445  | 0.213 | 114.170  |
| 49           | -9.005   | 0.355 | -76.848  | 8.007    | 2.514 | -42.656  | -33.996  | 0.020 | 49.390   | -12.285  | 0.243 | 89.641   |
| 50           | -6.637   | 0.466 | -89.734  | 6.902    | 2.214 | -83.972  | -34.691  | 0.018 | 15.240   | -11.324  | 0.272 | 78.671   |

Note:

1. Data obtained from on-wafer measurements.

**AMMC-5024 Typical Performance ( $T_{\text{chuck}} = 25^{\circ}\text{C}$ ,  $V_{\text{dd}} = 4\text{V}$ ,  $I_{\text{dd}} = 160\text{ mA}$ ,  $V_{\text{g2}} = \text{Open}$ ,  $Z_0 = 50\Omega$ )**

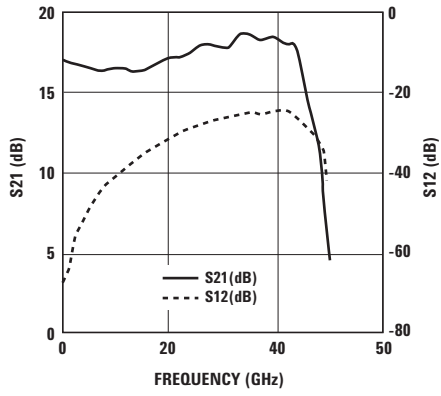

Figure 7. Gain and Reverse Isolation.

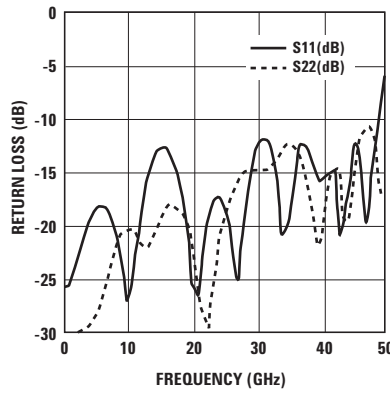

Figure 8. Return Loss (Input and Output).

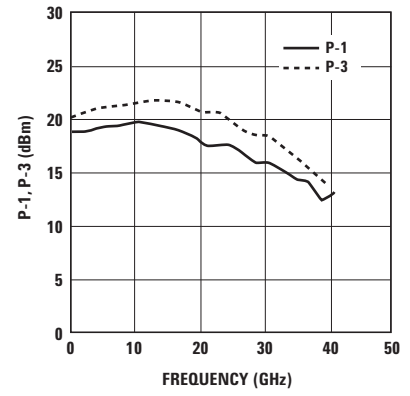

Figure 9. Output Power (P-1 and P-3).

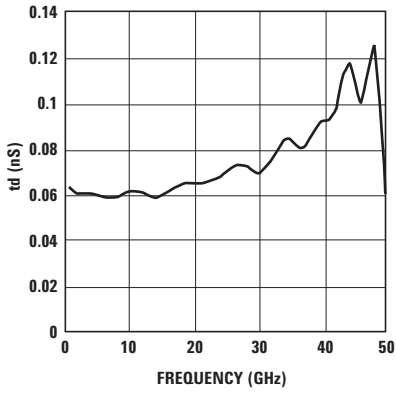

Figure 10. Group Delay.

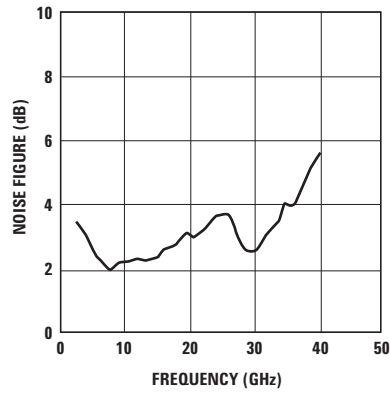

Figure 11. Noise Figure.

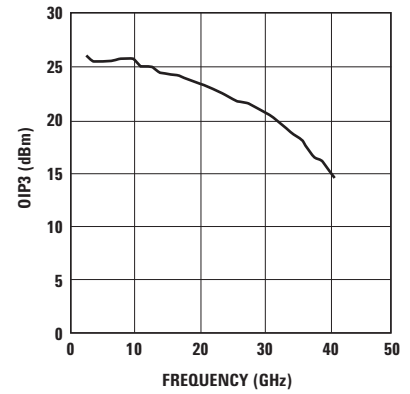

Figure 12. Output IP3.

**AMMC-5024 Typical Scattering Parameters<sup>[1]</sup> ( $T_{\text{chuck}} = 25^{\circ}\text{C}$ ,  $V_{\text{DD}} = 4\text{V}$ ,  $I_{\text{DD}} = 160\text{mA}$ ,  $Z_{\text{in}} = Z_{\text{out}} = 50\Omega$ )**

| Freq.<br>GHz | $S_{11}$ |       |          | $S_{21}$ |       |          | $S_{12}$ |       |          | $S_{22}$ |       |          |
|--------------|----------|-------|----------|----------|-------|----------|----------|-------|----------|----------|-------|----------|
|              | dB       | Mag   | Phase    | dB       | Mag   | Phase    | dB       | Mag   | Phase    | dB       | Mag   | Phase    |
| 0.05         | -26.046  | 0.050 | -175.110 | 16.908   | 7.005 | 179.610  | -59.336  | 0.001 | -61.940  | -32.459  | 0.024 | 16.703   |
| 1            | -25.998  | 0.050 | -164.940 | 16.786   | 6.907 | 156.790  | -65.942  | 0.001 | -108.900 | -34.057  | 0.020 | 5.690    |
| 2            | -24.392  | 0.060 | -151.920 | 16.727   | 6.860 | 135.230  | -59.134  | 0.001 | -128.490 | -31.519  | 0.027 | 17.159   |
| 3            | -22.084  | 0.079 | -147.760 | 16.657   | 6.805 | 113.560  | -54.398  | 0.002 | -158.090 | -30.113  | 0.031 | 12.590   |
| 4            | -20.032  | 0.100 | -152.230 | 16.538   | 6.713 | 92.010   | -52.371  | 0.002 | -178.300 | -29.546  | 0.033 | 10.367   |
| 5            | -18.871  | 0.114 | -160.550 | 16.419   | 6.621 | 70.825   | -49.621  | 0.003 | 161.460  | -28.527  | 0.037 | 9.842    |
| 6            | -18.430  | 0.120 | -170.290 | 16.305   | 6.535 | 49.938   | -47.520  | 0.004 | 141.190  | -26.705  | 0.046 | 8.417    |
| 7            | -18.727  | 0.116 | 179.750  | 16.225   | 6.475 | 29.369   | -45.659  | 0.005 | 119.280  | -24.546  | 0.059 | -0.474   |
| 8            | -19.934  | 0.101 | 170.600  | 16.227   | 6.476 | 8.799    | -43.865  | 0.006 | 97.498   | -22.558  | 0.074 | -17.521  |
| 9            | -22.656  | 0.074 | 164.210  | 16.287   | 6.522 | -12.033  | -42.482  | 0.008 | 74.972   | -21.031  | 0.089 | -41.715  |
| 10           | -27.478  | 0.042 | -179.640 | 16.384   | 6.595 | -33.532  | -41.201  | 0.009 | 53.471   | -20.499  | 0.094 | -72.840  |
| 11           | -25.347  | 0.054 | -126.840 | 16.410   | 6.614 | -55.435  | -40.162  | 0.010 | 31.594   | -20.801  | 0.091 | -112.770 |
| 12           | -19.749  | 0.103 | -120.480 | 16.336   | 6.559 | -77.463  | -39.239  | 0.011 | 10.910   | -21.844  | 0.081 | -161.860 |
| 13           | -16.206  | 0.155 | -131.310 | 16.209   | 6.464 | -98.816  | -38.327  | 0.012 | -9.819   | -22.131  | 0.078 | 138.490  |
| 14           | -14.011  | 0.199 | -146.840 | 16.158   | 6.425 | -119.500 | -37.323  | 0.014 | -29.734  | -20.818  | 0.091 | 82.104   |
| 15           | -12.962  | 0.225 | -164.520 | 16.210   | 6.464 | -140.230 | -36.407  | 0.015 | -50.251  | -19.513  | 0.106 | 36.945   |
| 16           | -12.935  | 0.226 | 176.980  | 16.352   | 6.570 | -161.440 | -35.276  | 0.017 | -72.076  | -18.421  | 0.120 | -0.979   |
| 17           | -13.689  | 0.207 | 159.730  | 16.530   | 6.707 | 176.800  | -34.270  | 0.019 | -94.562  | -18.158  | 0.124 | -34.038  |
| 18           | -15.570  | 0.167 | 143.690  | 16.717   | 6.853 | 154.440  | -33.419  | 0.021 | -118.010 | -18.744  | 0.116 | -67.232  |
| 19           | -19.085  | 0.111 | 128.620  | 16.846   | 6.955 | 131.460  | -32.607  | 0.023 | -141.710 | -20.205  | 0.098 | -96.759  |
| 20           | -25.363  | 0.054 | 133.080  | 16.926   | 7.020 | 108.520  | -31.889  | 0.025 | -166.020 | -23.130  | 0.070 | -128.700 |
| 21           | -26.442  | 0.048 | -165.970 | 16.965   | 7.051 | 85.461   | -31.268  | 0.027 | 169.730  | -27.569  | 0.042 | -173.310 |
| 22           | -20.900  | 0.090 | -156.420 | 17.054   | 7.124 | 62.568   | -30.682  | 0.029 | 145.660  | -33.534  | 0.021 | 98.102   |
| 23           | -18.349  | 0.121 | -172.490 | 17.170   | 7.220 | 39.543   | -30.022  | 0.032 | 121.250  | -26.084  | 0.050 | 10.942   |
| 24           | -17.560  | 0.132 | 168.580  | 17.320   | 7.345 | 16.078   | -29.439  | 0.034 | 96.409   | -21.809  | 0.081 | -29.430  |
| 25           | -18.343  | 0.121 | 145.730  | 17.534   | 7.528 | -8.082   | -28.885  | 0.036 | 70.972   | -18.685  | 0.116 | -66.154  |
| 26           | -20.831  | 0.091 | 110.490  | 17.708   | 7.680 | -32.996  | -28.374  | 0.038 | 44.076   | -16.869  | 0.143 | -100.080 |
| 27           | -25.482  | 0.053 | 47.234   | 17.813   | 7.774 | -58.575  | -27.893  | 0.040 | 17.025   | -15.693  | 0.164 | -136.500 |
| 28           | -21.019  | 0.089 | -43.397  | 17.786   | 7.750 | -84.438  | -27.722  | 0.041 | -10.669  | -15.062  | 0.177 | -174.690 |
| 29           | -15.842  | 0.161 | -84.248  | 17.674   | 7.651 | -110.030 | -27.501  | 0.042 | -38.170  | -15.047  | 0.177 | 144.500  |
| 30           | -13.096  | 0.221 | -115.690 | 17.547   | 7.540 | -134.660 | -27.408  | 0.043 | -65.246  | -15.045  | 0.177 | 101.700  |
| 31           | -11.817  | 0.257 | -144.730 | 17.670   | 7.648 | -159.020 | -27.130  | 0.044 | -92.100  | -14.911  | 0.180 | 56.891   |
| 32           | -12.588  | 0.235 | -171.610 | 17.969   | 7.915 | 175.550  | -26.768  | 0.046 | -119.520 | -14.657  | 0.185 | 6.430    |
| 33           | -14.900  | 0.180 | 163.390  | 18.362   | 8.282 | 148.060  | -26.185  | 0.049 | -148.970 | -13.556  | 0.210 | -42.887  |
| 34           | -21.159  | 0.088 | 161.170  | 18.588   | 8.500 | 118.310  | -25.723  | 0.052 | 179.060  | -12.691  | 0.232 | -92.108  |
| 35           | -20.309  | 0.097 | -141.280 | 18.465   | 8.380 | 88.090   | -25.559  | 0.053 | 145.960  | -12.218  | 0.245 | -138.540 |
| 36           | -14.744  | 0.183 | -158.220 | 18.201   | 8.130 | 59.059   | -25.633  | 0.052 | 113.580  | -13.056  | 0.222 | -178.190 |
| 37           | -12.538  | 0.236 | 170.230  | 18.066   | 8.004 | 30.963   | -25.760  | 0.052 | 82.862   | -14.378  | 0.191 | 143.400  |
| 38           | -13.339  | 0.215 | 132.480  | 18.167   | 8.098 | 1.607    | -25.749  | 0.052 | 52.499   | -16.970  | 0.142 | 116.660  |
| 39           | -15.011  | 0.178 | 78.005   | 18.276   | 8.200 | -29.543  | -25.454  | 0.053 | 20.356   | -21.811  | 0.081 | 111.200  |
| 40           | -16.105  | 0.157 | 6.891    | 18.189   | 8.118 | -62.709  | -25.424  | 0.054 | -13.439  | -20.840  | 0.091 | 134.530  |
| 41           | -14.757  | 0.183 | -61.000  | 17.917   | 7.868 | -95.764  | -25.415  | 0.054 | -47.607  | -16.035  | 0.158 | 118.260  |
| 42           | -15.383  | 0.170 | -108.170 | 17.784   | 7.748 | -128.890 | -25.467  | 0.053 | -83.226  | -15.120  | 0.175 | 80.564   |
| 43           | -21.471  | 0.084 | -141.240 | 17.922   | 7.872 | -165.490 | -25.277  | 0.054 | -122.260 | -16.069  | 0.157 | 25.234   |
| 44           | -18.182  | 0.123 | -72.748  | 17.442   | 7.449 | 151.790  | -25.857  | 0.051 | -166.580 | -19.776  | 0.103 | -75.636  |
| 45           | -12.590  | 0.235 | -105.520 | 15.750   | 6.130 | 110.450  | -27.536  | 0.042 | 150.440  | -14.233  | 0.194 | -173.290 |
| 46           | -13.269  | 0.217 | -153.320 | 13.940   | 4.978 | 75.442   | -29.470  | 0.034 | 112.520  | -11.523  | 0.265 | 139.690  |
| 47           | -20.284  | 0.097 | 126.900  | 12.983   | 4.458 | 40.022   | -30.994  | 0.028 | 73.538   | -10.251  | 0.307 | 102.000  |
| 48           | -14.029  | 0.199 | -5.310   | 11.793   | 3.887 | -5.741   | -33.295  | 0.022 | 27.040   | -12.501  | 0.237 | 75.692   |
| 49           | -9.656   | 0.329 | -41.069  | 7.696    | 2.426 | -50.048  | -39.913  | 0.010 | -10.430  | -17.076  | 0.140 | 74.549   |
| 50           | -5.683   | 0.520 | -68.263  | 4.495    | 1.678 | -69.558  | -44.196  | 0.006 | 11.969   | -12.434  | 0.239 | 98.012   |

Note:

1. Data obtained from on-wafer measurements.

**AMMC-5024 Typical Performance (Over Temperature and Voltage)**

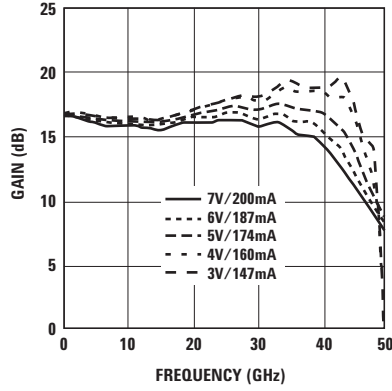

Figure 13. Gain and Voltage.

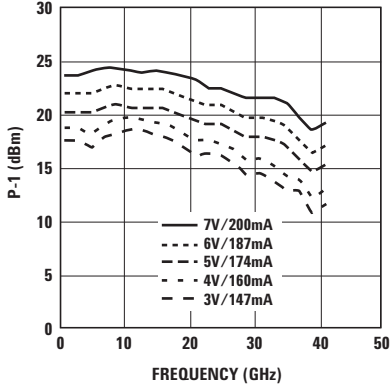

Figure 14. P-1 and Voltage.

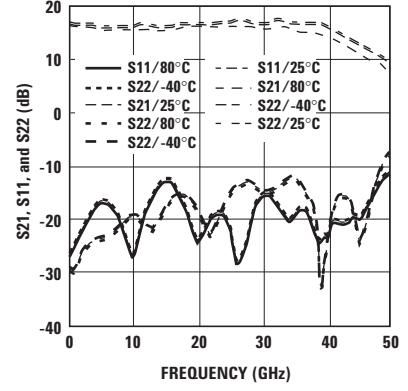

Figure 15. Gain and Return Loss with Temperature.

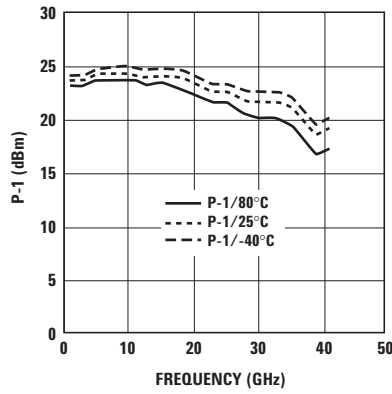

Figure 16. P-1 and Temperature,  $V_{dd}=7V$ ,  $I_{dd}=200$  mA.

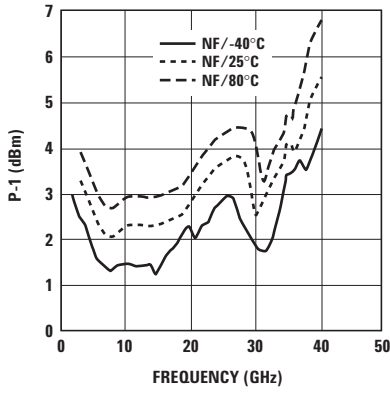

Figure 17. Noise Figure and Temperature at  $V_{dd}=4V$ ,  $I_{dd}=160$  mA.

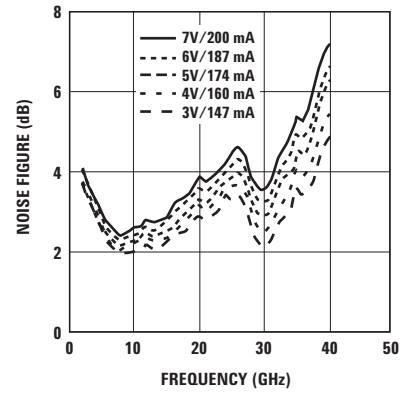

Figure 18. Noise Figure and Voltage.

## Biasing and Operation

AMMC-5024 is biased with a single positive drain supply ( $V_{dd}$ ) a negative gate supply ( $V_{g1}$ ). For best overall performance the recommended bias is  $V_{dd}=7V$  and  $I_{dd}=200$  mA. To achieve this drain current level,  $V_{g1}$  is typically between  $-2.5$  to  $-3.5V$ . Typically, DC current flow for  $V_{g1}$  is  $-10$  mA.

The AMMC-5024 has a second gate bias ( $Vg2$ ) that may be used for gain control. When not being utilized,  $Vg2$  should be left open-circuited.

This feature further enhances the versatility of applications where variable gain over a broad bandwidth is necessary.

This second gate bias ( $Vg2$ ) is connected to the gates of the upper FETs in each cascode stage through a small de-queing resistor. The other end of the gate line is terminated in an on-chip resistive/diode divider network, which allows the second gate to self-bias. Thus, with  $Vg2$  left open-circuited, the drain current is set by the ( $Vg1$ ) gate bias voltage applied to the lower FET in each stage.

The nominal open circuit voltage for  $Vg2$  is approximately 2 volts. Under this operating condition, maximum gain and power are achieved from the TWA.

By applying an external voltage to the second gate bias ( $Vg2$ ) less than the open-circuit potential, the drain voltage on the lower FET can be decreased to a point where the lower FET enters the linear operating region. This reduces the current drawn by each stage. Decreasing  $Vg2$  further will reduce the drain voltage on the lower FET towards zero while pinching off the upper FET in each stage. At larger negative values of  $Vg2$  (between 0 and  $-2.5$  volts) the gain of the TWA will decrease significantly.

Using the simplest form of assembly (Figure 20), the device is capable of delivering flat gain over a 2–50 GHz range with a minimum of gain slope and ripple. However, this device is designed with DC coupled RF I/O ports, and operation may be extended to lower frequencies (<2 GHz) through the use of off-chip low-frequency extension circuitry and proper external biasing components. With low frequency bias extension it may be used in a variety of time-domain applications (through 40 Gb/s).

Figure 21 shows a typical assembly configuration.

When bypass capacitors are connected to the AUX pads, the low frequency limit is extended down to the corner frequency determined by the bypass capacitor and the combination of the on-chip 50 ohm load and small de-queing resistor. At this frequency the small signal gain will increase in magnitude and stay at this elevated level down to the point where the  $C_{aux}$  bypass capacitor acts as an open circuit, effectively rolling off the gain completely. The low frequency limit can be approximated from the following equation:

$$f_{C_{aux}} = \frac{1}{2\pi C_{aux}(R_o + R_{DEQ})}$$

where:

$R_o$  is the 50Ω gate or drain line termination resistor.

$R_{DEQ}$  is the small series de-queing resistor and 10Ω.

$C_{aux}$  is the capacitance of the bypass capacitor connected to the AUX Drain pad in farads.

With the external bypass capacitors connected to the AUX gate and AUX drain pads, gain will show a slight increase between 1.0 and 1.5 GHz. This is due to a series combination of  $C_{aux}$  and the on chip resistance but is exaggerated by the parasitic inductance ( $L_c$ ) of the bypass capacitor and the inductance of the bond wire ( $L_d$ ). Therefore the bond wire from the Aux pads to the bypass capacitors should be made as short as possible.

Input and output RF ports are DC coupled; therefore, DC decoupling capacitors are required if there are DC paths. (Do not attempt to apply bias to these pads.)

RF bond connections should be kept as short as possible to reduce RF lead inductance which will degrade performance above 20 GHz.

An optional output power detector network is also provided. A  $>0.5$  μF capacitor is required for the Det\_Out pad to expand power detection performance below 100 MHz.

Ground connections are made with plated through-holes to the backside of the device; therefore, ground wires are not needed.



## Assembly Techniques

The backside of the MMIC chip is RF ground. For microstrip applications the chip should be attached directly to the ground plane (e.g. circuit carrier or heatsink) using electrically conductive epoxy<sup>[1,2]</sup>.

For best performance, the topside of the MMIC should be brought up to the same height as the circuit surrounding it. This can be accomplished by mounting a gold plated metal shim (same length as the MMIC) under the chip which is of correct thickness to make the chip and adjacent circuit the same height. The amount of epoxy used for the chip or shim attachment should be just enough to provide a thin fillet around the bottom perimeter of the chip. The ground plane should be free of any residue that may jeopardize electrical or mechanical attachment.

RF connections should be kept as short as reasonable to minimize performance degradation due to undesirable series inductance. A single bond wire is normally sufficient for single connections, however double bonding with 0.7mil gold wire will reduce series inductance. Gold thermo-sonic wedge bonding is the preferred method

for wire attachment to the bond pads. The recommended wire bond stage temperature is  $150^{\circ}\text{C} \pm 2^{\circ}\text{C}$ .

Caution should be taken to not exceed the Absolute Maximum Rating for assembly temperature and time.

The chip is 100um thick and should be handled with care. This MMIC has exposed air bridges on the top surface and should be handled by the edges or with a custom collet (do not pick up the die with a vacuum on die center). Bonding pads and chip backside metallization are gold.

This MMIC is also static sensitive and ESD precautions should be taken. Eutectic attach is not recommended and may jeopardize reliability of the device.

For more detailed information see Avago Technologies' Application Note #5359 "GaAs MMIC assembly and handling guidelines".

Notes:

1. Ablebond 84-1 LMI silver epoxy is recommended
2. Eutectic attach is not recommended and may jeopardize reliability of the device

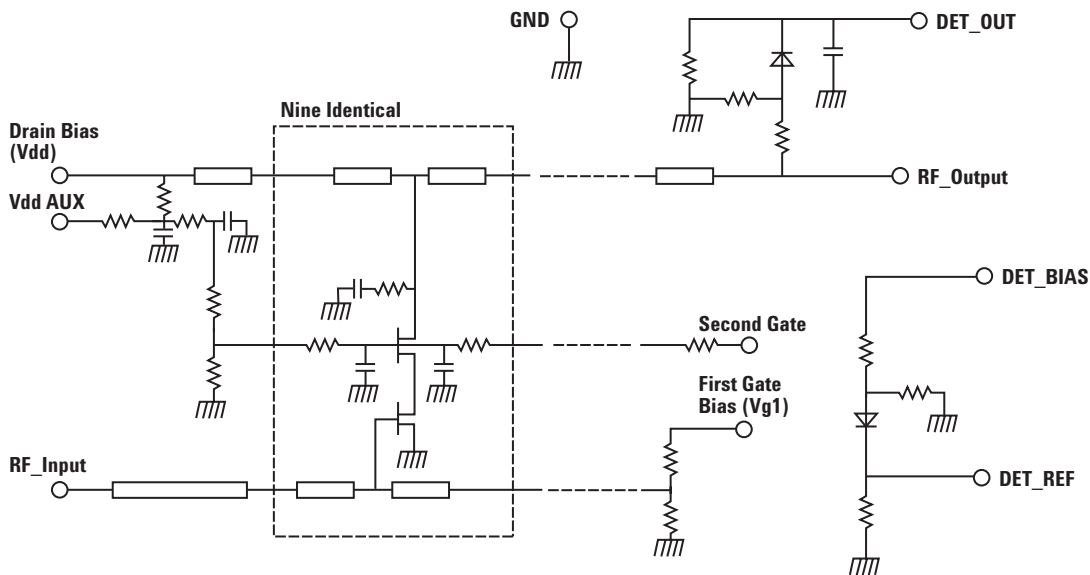

Figure 19. AMMC-5024 Schematic.

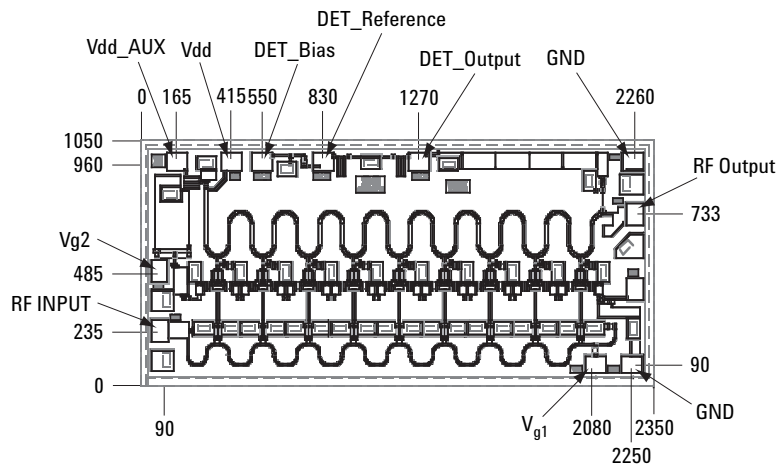

Figure 20. AMMC-5024 Bonding Pad Locations. (dimensions in micrometers)

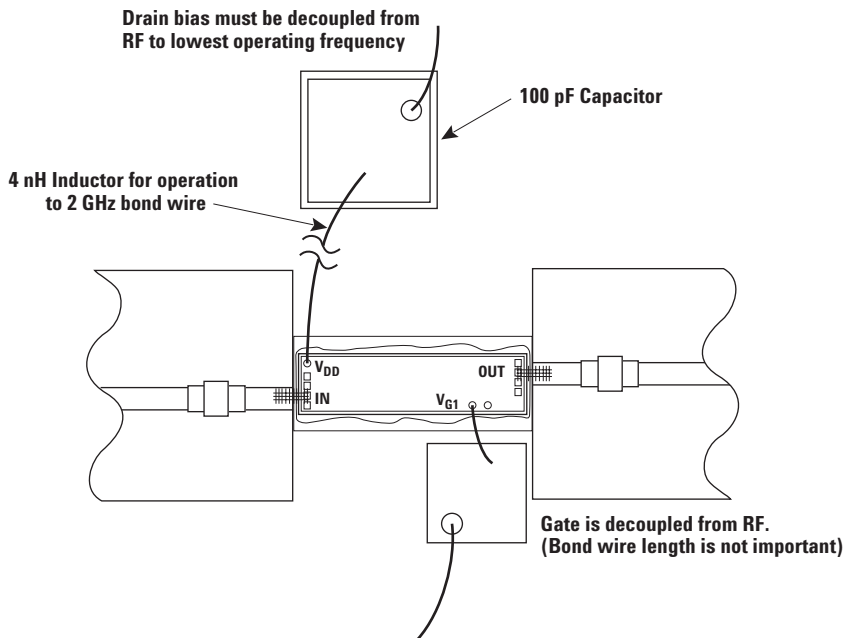

Figure 21. AMMC-5024 Assembly Diagram.

### Ordering Information

AMMC-5024-W10 = 10 devices per tray

AMMC-5024-W50 = 50 devices per tray

For product information and a complete list of distributors, please go to our web site: [www.avagotech.com](http://www.avagotech.com)

Avago, Avago Technologies, and the A logo are trademarks of Avago Technologies in the United States and other countries. Data subject to change. Copyright © 2005-2008 Avago Technologies. All rights reserved. Obsoletes 5989-3931EN AV02-0632EN - September 8, 2008

