

## SIKOREL®

### Applications

- For compact design in automotive applications

### Features

- High ripple current capability
- High vibration resistance
- Very low ESR at low temperature, down to – 55 °C
- Compact and small design
- High reliability

### Construction

- Charge-discharge proof, polar
- Aluminum case with insulating sleeve
- Negative pole connected to case

### Terminals

- Axial leads, welded to ensure perfect electrical contact
- Also available with soldering stars

### Taping and packing

- Axial-lead capacitors will be delivered in pallet package.  
Capacitors with  $d \times l \leq 16 \times 30$  mm are also available taped on reel.
- Solder-star capacitors are packed in cardboard.

For details on taping and packing, refer to page 342.

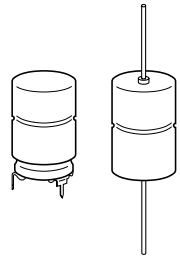

KAL0573-K

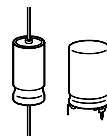
**Specifications and characteristics in brief**

Rated voltage $U_R$	25 and 40 VDC					
Surge voltage $U_S$	$1,15 \cdot U_R$					
Rated capacitance $C_R$	470 ... 3 300 $\mu$ F					
Capacitance tolerance	– 10/+ 30 % $\triangle$ Q					
Leakage current $I_L$ (5 min, 20 °C)	$I_L \leq 0,006 \mu\text{A} \cdot \left( \frac{C_R}{\mu\text{F}} \cdot \frac{U_R}{\text{V}} \right) + 4 \mu\text{A}$					
Self-inductance $ESL^{1)}$	Diameter $d$	12 mm	14 mm	16 mm	18 mm	
	Length $l$	Terminal	Approx. $ESL$ (nH)			
	25 mm	axial / solder star	— / —	22 / 6	26 / 7	— / —
	30 mm	axial / solder star	21 / 6	24 / 7	29 / 8	34 / 10
	39 mm	axial / solder star	— / —	— / —	33 / 9	38 / 11
Useful life 125 °C; $U_R$ ; $I_{-R}$ 85 °C; $U_R$ ; $I_{-max}$ 40 °C; $U_R$ ; $2,9 \cdot I_{-R}$	> 3 000 h	<b>Requirements:</b> $\Delta C/C$ $\leq \pm 30$ % of initial value $ESR$ $\leq 3$ times initial specified limit $I_L$ $\leq$ initial specified limit Failure percentage: $\leq 0,5$ % Failure rate: $\leq 10$ fit ( $\leq 10 \cdot 10^{-9}/\text{h}$ ) (for definition "fit", refer to chapter "Quality", page 62)				
	> 15 000 h					
> 200 000 h						
Voltage endurance test 125 °C, $U_R$	2 000 h	<b>Post test requirements:</b>				
		$\Delta C/C$	$\leq \pm 10$ % of initial value			
		$ESR$	$\leq 1,3$ % initial specified limit			
		$I_L$	$\leq$ initial specified limit			
Vibration resistance	To IEC 60068-2-6, test Fc: displacement amplitude 1,5 mm, at 10 Hz to 2 kHz, acceleration max. 20 g, duration $3 \times 2$ h					
IEC climatic category	To IEC 60068-1: 55/125/56 (– 55 °C/+ 125 °C/56 days damp heat test)					
Detail specification	Similar to CECC 30301-802					
Sectional specification	IEC 60384-4					

1) If optimum circuit design is used, the values are lower by 30 %.

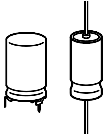

B41696 / B41796

Low ESR, Compact – 125 °C

## Dimensional drawings

### Axial-lead capacitor

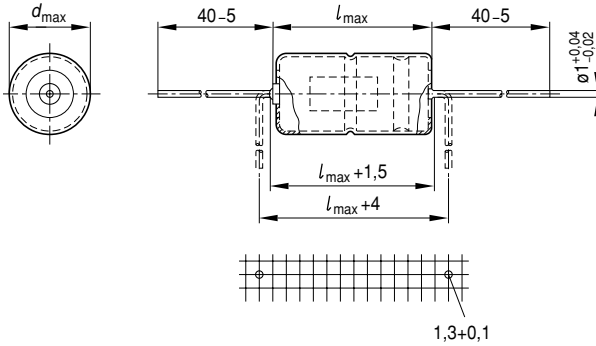

KAL0524-S

### Dimensions, weights and packing units

$d \times l$ mm	$d_{\max} \times l_{\max}$ mm	Approx. weight g	Packing units (pieces)	
			Pallet	Reel
12 × 30	12,5 × 30,5	5,1	288	450
14 × 25	14,5 × 25,5	5,7	200	350
16 × 30	16,5 × 30,5	8,9	180	250
18 × 39	18,5 × 40	14,7	160	—

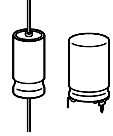
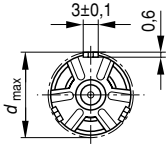
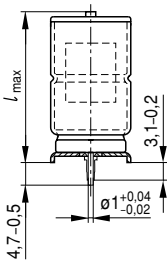
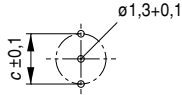
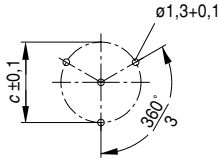

**Soldering star capacitors**

 Mounting holes  
 $d = 12 \text{ mm} \dots 14 \text{ mm}$ 

 Mounting holes  
 $d = 16 \text{ mm} \dots 18 \text{ mm}$ 

Soldering star is connected to the negative pole

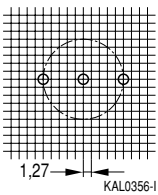
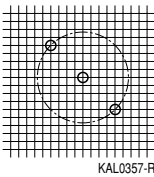
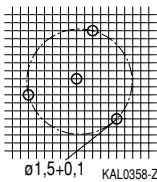
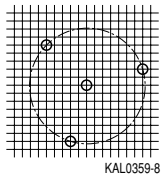
KAL0525-1-E

The PC-board hole arrangement specified above is based on circular arcs.

 If, however, the mounting holes have to be matched to a standard drilling raster, a spacing of 1,27 mm ( $1/20''$ ) has proved to be sufficiently accurate if the following arrangements are used:

 $d = 12 \text{ mm}$ 

 $d = 14 \text{ mm}$ 

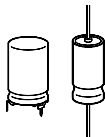
 $d = 16 \text{ mm}$ 

 $d = 18 \text{ mm}$ 

**Dimensions, weights and packing units**

$d \times l$ mm	$d_{\text{max}} \times l_{\text{max}}$ mm	$c \pm 0,1$ mm	Approx. weight g	Packing units pieces
12 × 30	13,5 × 32	12,5	5,4	480
14 × 25	15,5 × 27	14,5	6,1	480
16 × 30	17,5 × 32	16,5	9,4	300
18 × 39	19,5 × 41,5	18,5	15,4	200

**B41696 / B41796**
**Low ESR, Compact – 125 °C**
**Overview of available types**

$U_R$ (VDC)	25	40
$C_R$ ( $\mu$ F)	Case dimensions $d \times l$ (mm)	
470		12 × 30
680	12 × 30	
1 000	14 × 25	16 × 30
2 200		18 × 39
3 300	18 × 39	

**Case dimensions and ordering codes**

$U_R$ VDC	$C_R$ $\mu$ F	Case dim. $d \times l$ mm	Ordering code		Soldering star
			Axial pallet package	Axial reel	
25	680	12 × 30	B41696A5687Q007	B41696A5687Q009	B41796A5687Q000
	1 000	14 × 25	B41696A5108Q007	B41696A5108Q009	B41796A5108Q000
	3 300	18 × 39	B41696A5338Q007		B41796A5338Q000
40	470	12 × 30	B41696A7477Q007	B41696A7477Q009	B41796A7477Q000
	1 000	16 × 30	B41696A7108Q007	B41696A7108Q009	B41796A7108Q000
	2 200	18 × 39	B41696A7228Q007		B41796A7228Q000

**Technical data**

$C_R$ 100 Hz 20 °C $\mu$ F	$ESR_{typ}$ 100 Hz 20 °C m $\Omega$	$ESR_{max}$ 100 Hz 20 °C m $\Omega$	$ESR_{max}$ 100 Hz -40 °C $\Omega$	$ESR_{max}$ 10 kHz 20 °C m $\Omega$	$Z_{max}$ 100 kHz 20 °C m $\Omega$	$I_{\sim max}$ 10 kHz 40 °C A	$I_{\sim max}$ 10 kHz 85 °C A	$I_{\sim R}$ 10 kHz 125 °C A
<b>25 VDC</b>								
680	110	170	1,20	95	90	5,40	4,25	1,60
1 000	80	120	0,65	70	68	5,70	4,50	1,70
3 300	30	45	0,20	25	24	11,50	9,20	3,50
<b>40 VDC</b>								
470	110	180	0,90	75	72	5,80	4,60	1,75
1 000	60	90	0,45	45	44	8,00	6,30	2,40
2 200	30	50	0,20	25	24	11,50	9,20	3,50

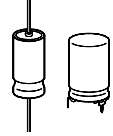

**Useful life**

depending on ambient temperature  $T_A$  under ripple current operating conditions at  $U_R^{1)}$

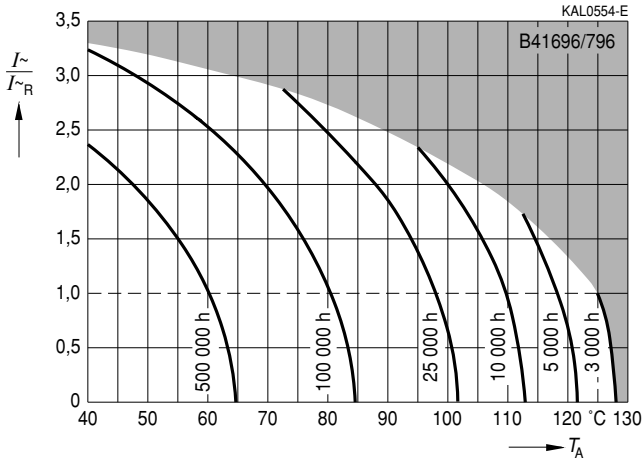

**Useful life**

depending on case temperature  $T_C$  under ripple current operating conditions at  $U_R^{1)}$

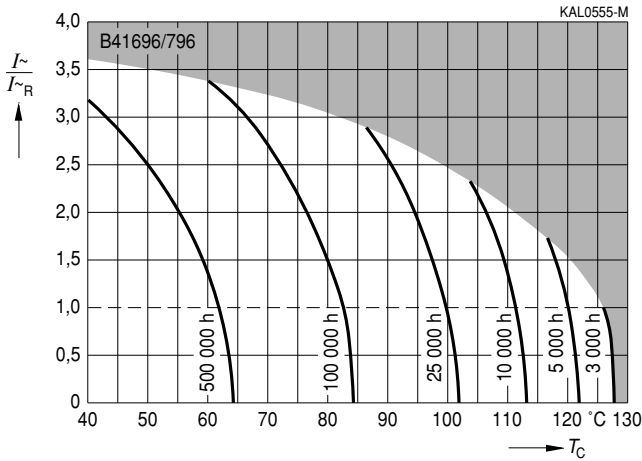

1) Refer to page 40 for an explanation on how to interpret the useful life graphs.

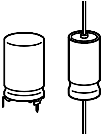

**B41696 / B41796**

**Low ESR, Compact – 125 °C**

**Frequency factor of permissible ripple current  $I_{\tilde{r}}$  versus frequency  $f$**

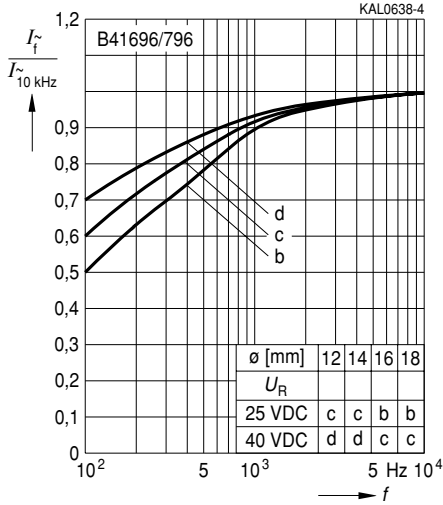

**Frequency characteristics of ESR at different temperatures typical behavior**

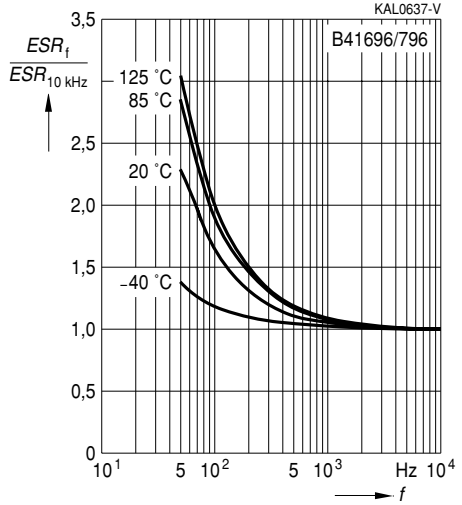

**Equivalent series resistance ESR versus frequency  $f$  at different temperatures Typical behavior for 2 200  $\mu$ F/40 V**

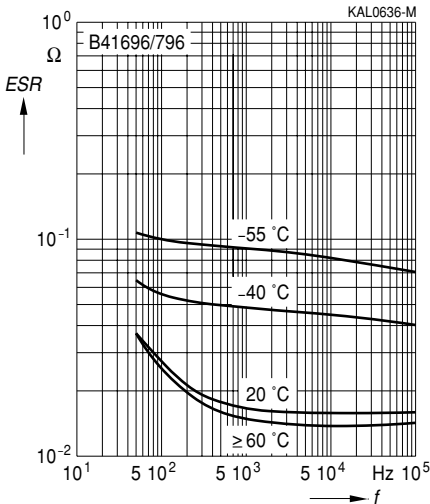

**Impedance Z versus frequency  $f$  at different temperatures Typical behavior for 2 200  $\mu$ F/40 V**

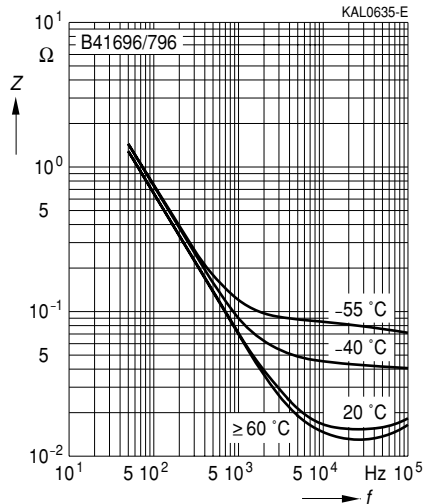

**Herausgegeben von EPCOS AG**

**Unternehmenskommunikation, Postfach 80 17 09, 81617 München, DEUTSCHLAND**

**☎ ++49 89 636 09, FAX (0 89) 636-2 26 89**

© EPCOS AG 2002. Vervielfältigung, Veröffentlichung, Verbreitung und Verwertung dieser Broschüre und ihres Inhalts ohne ausdrückliche Genehmigung der EPCOS AG nicht gestattet.

Bestellungen unterliegen den vom ZVEI empfohlenen Allgemeinen Lieferbedingungen für Erzeugnisse und Leistungen der Elektroindustrie, soweit nichts anderes vereinbart wird.

Diese Broschüre ersetzt die vorige Ausgabe.

Fragen über Technik, Preise und Liefermöglichkeiten richten Sie bitte an den Ihnen nächstgelegenen Vertrieb der EPCOS AG oder an unsere Vertriebsgesellschaften im Ausland. Bauelemente können aufgrund technischer Erfordernisse Gefahrstoffe enthalten. Auskünfte darüber bitten wir unter Angabe des betreffenden Typs ebenfalls über die zuständige Vertriebsgesellschaft einzuholen.

**Published by EPCOS AG**

**Corporate Communications, P.O. Box 80 17 09, 81617 Munich, GERMANY**

**☎ ++49 89 636 09, FAX (0 89) 636-2 26 89**

© EPCOS AG 2002. Reproduction, publication and dissemination of this brochure and the information contained therein without EPCOS' prior express consent is prohibited.

Purchase orders are subject to the General Conditions for the Supply of Products and Services of the Electrical and Electronics Industry recommended by the ZVEI (German Electrical and Electronic Manufacturers' Association), unless otherwise agreed.

This brochure replaces the previous edition.

For questions on technology, prices and delivery please contact the Sales Offices of EPCOS AG or the international Representatives.

Due to technical requirements components may contain dangerous substances. For information on the type in question please also contact one of our Sales Offices.