

# Features

# Regulated Converters

- Wide 4:1 Input Voltage Range
- 1.6kVDC Isolation
- Efficiency up to 89%
- Six-Sided Continuous Shield
- EN50155, UL60950 Certified



## RP20-FR

20 Watt  
2" x 1"  
Single & Dual Output



### Description

The RP20-FR series wide range input DC/DC converters are certified to UL60950-1 and cUL 60950-1. This makes them ideal for all telecom and industrial applications where approved safety standards are required. The 110VDC input versions have been especially designed for railway applications.

### Selection Guide

Part Number	Input Voltage Range [VDC]	Output Voltage [VDC]	Output Current [mA]	Input <sup>(1)</sup> Current [mA]	Efficiency <sup>(1)</sup> typ. [%]	Max. Capacitive Load [μF]
RP20-243.3SFR <sup>(2,3)</sup>	9-36	3.3	4500	728	85	7000
RP20-2405SFR <sup>(2,3)</sup>	9-36	5	4000	947	88	5000
RP20-2412SFR <sup>(2,3)</sup>	9-36	12	1670	938	89	850
RP20-2415SFR <sup>(2,3)</sup>	9-36	15	1330	945	88	700
RP20-483.3SFR <sup>(2,3)</sup>	18-75	3.3	4500	364	85	7000
RP20-4805SFR <sup>(2,3)</sup>	18-75	5	4000	473	88	5000
RP20-4812SFR <sup>(2,3)</sup>	18-75	12	1670	469	89	850
RP20-4815SFR <sup>(2,3)</sup>	18-75	15	1330	467	89	700
RP20-1103.3SFR <sup>(2,3)</sup>	43-160	3.3	4500	159	85	7000
RP20-11005SFR <sup>(2,3)</sup>	43-160	5	4000	209	87	5000
RP20-11012SFR <sup>(2,3)</sup>	43-160	12	1670	207	88	850
RP20-11015SFR <sup>(2,3)</sup>	43-160	15	1330	206	88	700
RP20-2412DFR <sup>(2,3)</sup>	9-36	±12	±833	947	88	±500
RP20-2415DFR <sup>(2,3)</sup>	9-36	±15	±667	937	89	±350
RP20-4812DFR <sup>(2,3)</sup>	18-75	±12	±833	473	88	±500
RP20-4815DFR <sup>(2,3)</sup>	18-75	±15	±667	468	89	±350
RP20-11012DFR <sup>(2,3)</sup>	43-160	±12	±833	207	88	±500
RP20-11015DFR <sup>(2,3)</sup>	43-160	±15	±667	204	89	±350

**Notes:**

Note1: at nominal input voltage and full load



### Model Numbering

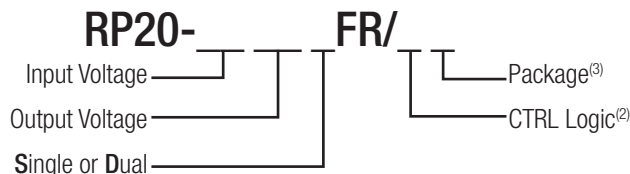

**Ordering Examples**

- RP20-2405SFR/P = 24V Input, 5V Output, Positive Logic CTRL pin and Trim pin fitted
- RP20-4812DFR/N-HC = 48V Input, ±12V Output, Negative Logic CTRL pin, with fitted Heat-sink
- RP20-2405SFR/XC = 24V Input, 5V Output, no CTRL pin and Trim pin fitted

**Notes:**

- Note2: standard part is with suffix "P" for positive logic (1=ON, 0=OFF) and trim pin or add suffix "N" instead for negative logic (0=ON, 1=OFF) and trim pin or add suffix "XC" instead for no CTRL pin (0=ON, 1=OFF) and trim pin
- Note3: add suffix "-HC" for premounted Heat-sink with clamps

EN50155 Certified  
UL60950 Certified  
CSA C22.2 No.601.1 Certified

**Specifications** measured at Ta = 25°C, nominal input voltage, full load otherwise noted

BASIC CHARACTERISTICS					
Parameter	Condition		Min.	Typ.	Max.
Input Voltage Range	nom. Vin = 24V nom. Vin = 48V nom. Vin = 110V		9VDC 18VDC 43VDC	24VDC 48VDC 110VDC	36VDC 75VDC 160VDC
Under Voltage Lockout (UVLO)	Vin = 24V	DC-DC ON DC-DC OFF		8VDC	9VDC
	Vin = 48V	DC-DC ON DC-DC OFF		16VDC	18VDC
	Vin = 110V	DC-DC ON DC-DC OFF		40VDC	43VDC
Input Filter	24Vin, 48Vin		Common Mode Choke		
	110Vin		Pi-Type		
Input Reflected Ripple Current	nominal Vin and full load			30mA <sub>p-p</sub>	
Input Surge Voltage	Vin = 24V, 100 ms max. Vin = 48V, 100 ms max. Vin = 110V, 100 ms max.				50VDC 100VDC 170VDC
Start-up time	Power up				30ms
	Remote ON/OFF				30ms
Operating Frequency Range			297kHz	330kHz	363kHz
Ripple and Noise	measured by 20Mhz bandwidth with a 1µF/50V X7R MLCC	3.3V <sub>out</sub> , 5V <sub>out</sub> 12V <sub>out</sub> , 15V <sub>out</sub>		75mV <sub>p-p</sub> 100mV <sub>p-p</sub>	
Remote ON/OFF <sup>(4)</sup>	Positive Logic	DC-DC ON DC-DC OFF	Open or 3.0V < Vr < 15V Short or 0V < Vr < 1.2V		
	Negative Logic	DC-DC ON DC-DC OFF	Short or 0V < Vr < 1.2V Open or 3.0V < Vr < 15V		
Input current of Remote pin (CTRL)	DC-DC OFF			2.5mA	
	DC-DC ON		-0.5mA		1.0mA

**Notes:**

Note4: The ON/OFF control function can be positive or negative logic. The pin voltage is referenced to -Vin pin.  
If no suffix is specified, the control pin will be omitted.

**RP20-2405SFR**

**Efficiency vs. Output Current**

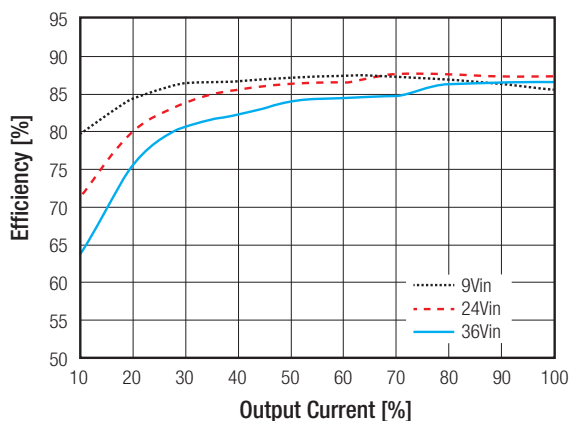

**Efficiency vs. Input Voltage full load**

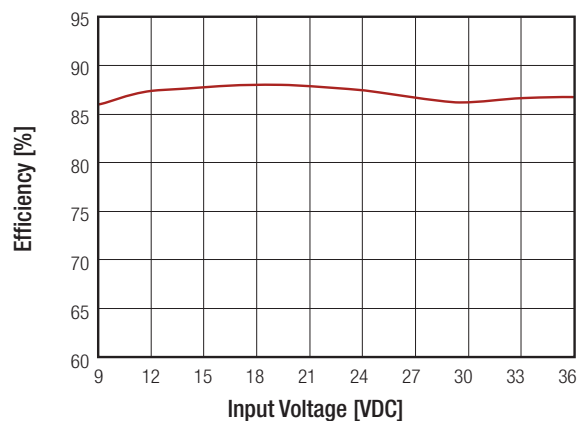

continued on next page

Specifications measured at Ta = 25°C, nominal input voltage, full load otherwise noted

**RP20-4805SFR**

Efficiency vs. Output Current

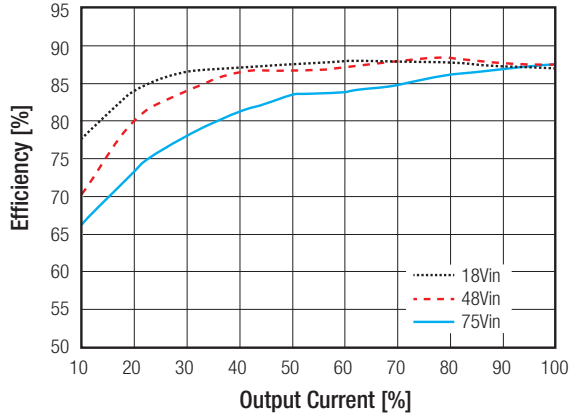

Efficiency vs. Input Voltage full load

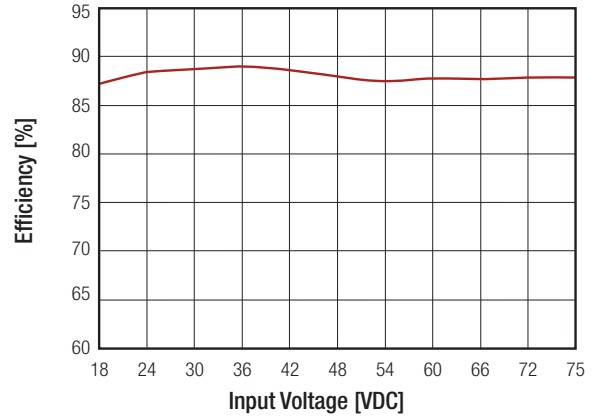

**RP20-1105SFR**

Efficiency vs. Output Current

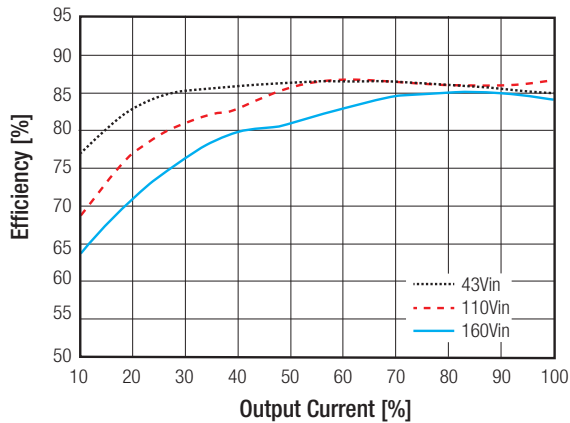

Efficiency vs. Input Voltage full load

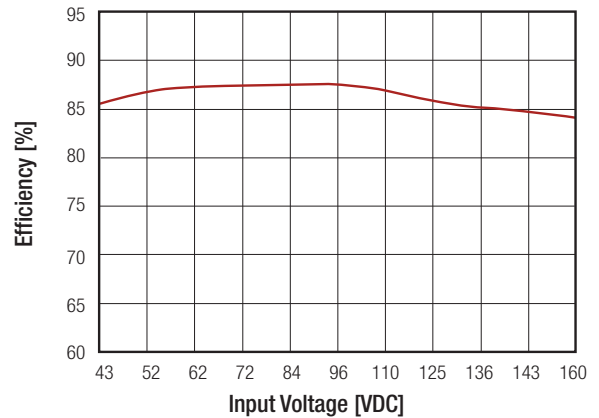

**REGULATIONS**

Parameter	Condition		Value
Output Voltage Accuracy	full load and nominal Vin		±1%
Voltage Adjustability	Single		±10%
Line Voltage Regulation	low line to high line at full load	Single	±0.2%
		Dual	±0.5%
Load Voltage Regulation	0% to 100% load	Single	±0.2%
		Dual	±1.0%
	10% load to 90% load	Single	±0.1%
		Dual	±0.8%
Cross Regulation	asymmetrical 25% <> 100% load		±5%
Transient Response recovery time	25% load step change		250µs typ.

continued on next page

**Specifications** measured at  $T_a = 25^\circ\text{C}$ , nominal input voltage, full load otherwise noted

## External Output Trimming

### Output Voltage Trimming

Single output Powerline converters offer the feature of trimming the output voltage over a certain range around the nominal value by using external trim resistors. No general equation can be given for calculating the trim resistors, but the following trimtables give typical values for choosing these trimming resistors. If voltages between the given trim points are required, extrapolate between the two nearest given values to work out the resistor required or use a variable resistor to set the output voltage.

Output can be externally trimmed by using the method shown below.

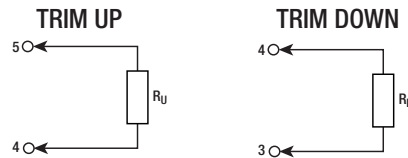

### RP20-xx3.3SFR

Trim up	1	2	3	4	5	6	7	8	9	10	%
V <sub>out</sub> =	3.333	3.366	3.399	3.432	3.465	3.498	3.531	3.564	3.597	3.63	Volts
R <sub>U</sub> =	385.07	191.51	126.99	94.73	75.37	62.47	53.25	46.34	40.96	36.66	KOhms
Trim down	1	2	3	4	5	6	7	8	9	10	%
V <sub>out</sub> =	3.267	3.234	3.201	3.168	3.135	3.102	3.069	3.036	3.003	2.97	Volts
R <sub>D</sub> =	116.72	54.78	34.13	23.81	17.62	13.49	10.54	8.33	6.60	5.23	KOhms

### RP20-xx05SFR

Trim up	1	2	3	4	5	6	7	8	9	10	%
V <sub>out</sub> =	5.05	5.10	5.15	5.20	5.25	5.30	5.35	5.4	5.45	5.50	Volts
R <sub>U</sub> =	253.45	125.70	83.18	61.83	49.05	40.53	34.45	29.89	26.34	23.50	KOhms
Trim down	1	2	3	4	5	6	7	8	9	10	%
V <sub>out</sub> =	4.95	4.90	4.85	4.80	4.75	4.70	4.65	4.60	4.55	4.50	Volts
R <sub>D</sub> =	248.34	120.59	78.01	56.72	43.94	35.42	29.34	24.78	21.23	18.39	KOhms

### RP20-xx12SFR

Trim up	1	2	3	4	5	6	7	8	9	10	%
V <sub>out</sub> =	12.12	12.24	12.36	12.48	12.60	12.72	12.84	12.96	13.08	13.20	Volts
R <sub>U</sub> =	203.22	99.06	64.33	46.97	36.56	29.61	24.65	20.93	18.04	15.72	KOhms
Trim down	1	2	3	4	5	6	7	8	9	10	%
V <sub>out</sub> =	11.88	11.76	11.64	11.52	11.40	11.28	11.16	11.04	10.92	10.8	Volts
R <sub>D</sub> =	776.56	380.72	248.78	182.81	143.22	116.83	97.99	83.84	72.85	64.06	KOhms

### RP20-xx15SFR

Trim up	1	2	3	4	5	6	7	8	9	10	%
V <sub>out</sub> =	15.15	15.3	15.45	15.60	15.75	15.90	16.05	16.20	16.35	16.50	Volts
R <sub>U</sub> =	161.56	78.22	50.45	36.56	28.22	22.67	18.70	15.72	13.41	11.56	KOhms
Trim down	1	2	3	4	5	6	7	8	9	10	%
V <sub>out</sub> =	14.85	14.70	14.55	14.40	14.25	14.10	13.95	13.80	13.65	13.50	Volts
R <sub>D</sub> =	515.22	401.56	262.67	193.22	151.56	123.78	103.94	89.06	77.48	68.22	KOhms

**Specifications** measured at Ta = 25°C, nominal input voltage, full load otherwise noted

**PROTECTIONS**

Parameter	Condition	Value
Short Circuit Protection (SCP)		continuous, automatic recovery
Over Voltage Protection (OVP)	Zener Diode Clamp	3.3Vout
		5Vout
		12Vout
		15Vout
Over Load Protection (OLP)	% Iout rated	150% typ.
Isolation Voltage	I/P to O/P	1.6kVDC/1minute
	I/P to O/P to case	1.6kVDC/1minute
Isolation Resistance	500 VDC	1GΩ min.
Isolation Capacitance		3000pF max.

**Notes:**

Note5: This power module is not internally fused. An input line fuse must always be used.

**ENVIRONMENTAL**

Parameter	Condition	Value
Operating Temperature Range	without derating	-40°C to +79°C
	with derating	-40°C to +101°C
Maximum Case Temperature		+105°C
Temperature Coefficient		±0.02%/°C max.
Thermal Impedance	Natural convection (20LFM) without Heat-sink	12°C/W
	Natural convection (20LFM) with Heat-sink	10°C/W
Operating Humidity		5% - 95% RH
Shock		EN61373, MIL-STD-810F
Thermal Shock		MIL-STD-810F
Vibration		EN61373, MIL-STD-810F
MTBF	MIL-HDBK-217F	1523 x 10 <sup>3</sup> hours

**Derating Graph<sup>(6)</sup>**

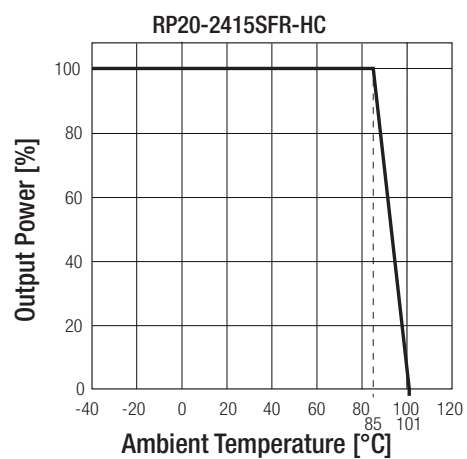
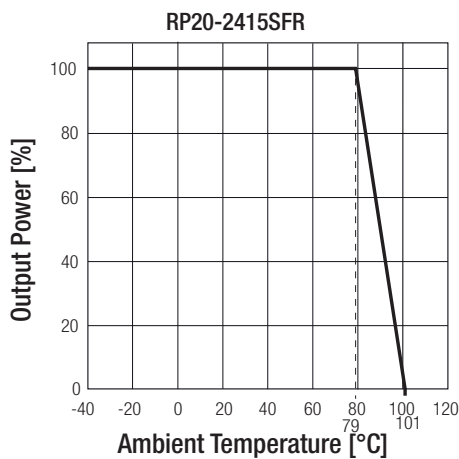

**Notes:**

Note6: Derating graphs are valid only for the shown part numbers. If you need detailed derating-information about a part-number not shown here please contact our technical support service at techsupportAT@recom-power.com

**Specifications** measured at  $T_a = 25^\circ\text{C}$ , nominal input voltage, full load otherwise noted

**SAFETY AND CERTIFICATIONS**

Certificate Type (Safety)	Report / File Number	Standard
Information Technology Equipment, General Requirements for Safety	E196683	UL60950-1, 2nd Edition CSA C22.2 No. 601.1
Railway Applications - Electrical Equipment used on rolling stock	15A100704E-C	EN50155
EMI Compliance	Condition	Standard / Criterion
Industrial, scientific and medical equipment - Radio frequency disturbance characteristics - Limits and methods of measurement <sup>(7)</sup>		EN55011, Class A and B
Information technology equipment - Radio disturbance characteristics - Limits and methods of measurement <sup>(7)</sup>		EN55022, Class A and B
ESD Electrostatic discharge immunity test	Air $\pm 8\text{kV}$ and Contact $\pm 6\text{kV}$	EN61000-4-2, Criteria A
Radiated, radio-frequency, electromagnetic field immunity test	10 V/m	EN61000-4-3, Criteria A
Fast Transient and Burst Immunity <sup>(8)</sup>	$\pm 2\text{kV}$	EN61000-4-4, Criteria A
Surge Immunity <sup>(8)</sup>	$\pm 2\text{kV}$	EN61000-4-5, Criteria A
Immunity to conducted disturbances, induced by radio-frequency fields	10 Vr.m.s	EN61000-4-6, Criteria A
Power Magnetic Field Immunity	100A/m continuous; 1000A/m 1s	EN61000-4-8, Criteria A

**Notes:**

Note7: The 24VDC & 48VDC input standard modules meet EN55022 & EN55011 Class B without external components, 110VDC input meet EN55022 Class A without external components and meet Class B with external components.

Note8: An external input filter capacitor is required if the module has to meet EN61000-4-4, -5.

The filter Recom suggests: 24VDC and 48VDC input. Nippon chemi-con KY series, 220 $\mu\text{F}$ /100V.

110VDC input: Rubycon BXF series, 100 $\mu\text{F}$ /250V

**EMC Railway Class A**

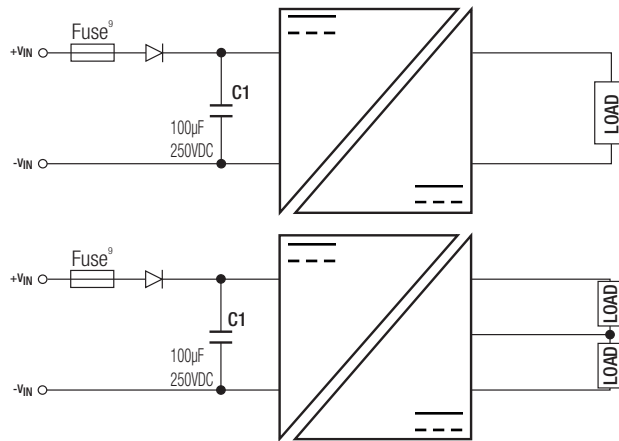

**EMC Filtering Class B**

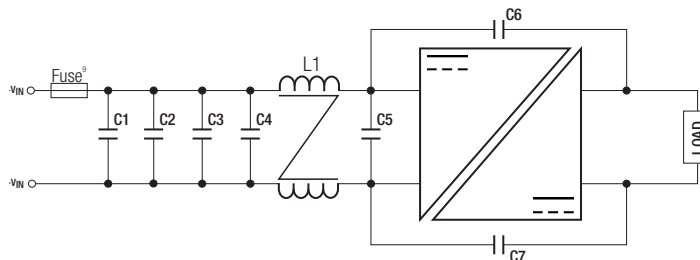

continued on next page

**Specifications** measured at Ta = 25°C, nominal input voltage, full load otherwise noted

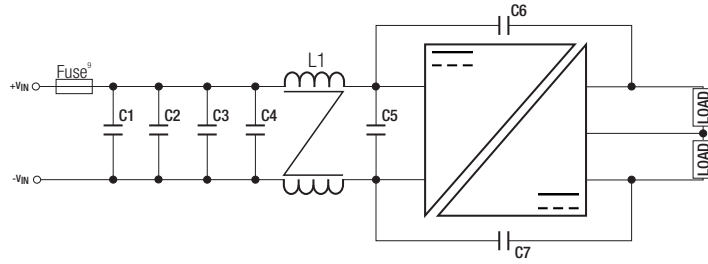

MODEL	C1	C2/C3/C4	C7	L1
RP20-110xxSFR	39µF/250V Al Cap. (lie down) Rubycon BX	0.47µF/250V 1812 MLCC	1000pF/3kV 1808 MLCC	CMC: 470µH ref.: WE-SL5 744272471

**Notes:**

Note9: Use fuse or over-current protection.

**DIMENSIONS and PHYSICAL CHARACTERISTICS**

Parameter	Type	Value
Material	Case	Nickel coated copper
	Base	FR4 PCB
	Potting	Silicone (UL94V-0)
Packaging Dimension (LxWxH)	without Heat-sink	50.8 x 25.4 x 10.2mm
	with Heat-sink	56.8 x 25.4 x 16.8mm
Packaging Weight	without Heat-sink	30g
	with Heat-sink	41g

**Dimension Drawing (mm)**

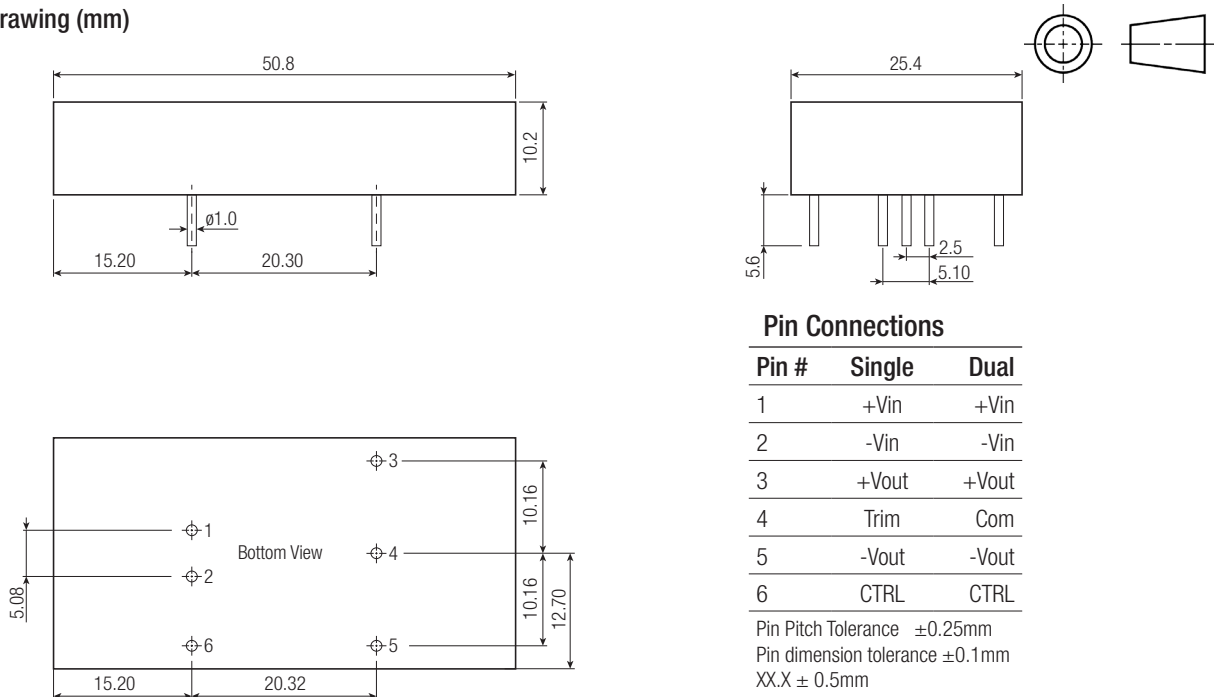

**Pin Connections**

Pin #	Single	Dual
1	+Vin	+Vin
2	-Vin	-Vin
3	+Vout	+Vout
4	Trim	Com
5	-Vout	-Vout
6	CTRL	CTRL

Pin Pitch Tolerance ±0.25mm  
Pin dimension tolerance ±0.1mm  
XX.X ± 0.5mm  
XX.XX ± 0.25mm

**Specifications** measured at Ta = 25°C, nominal input voltage, full load otherwise noted

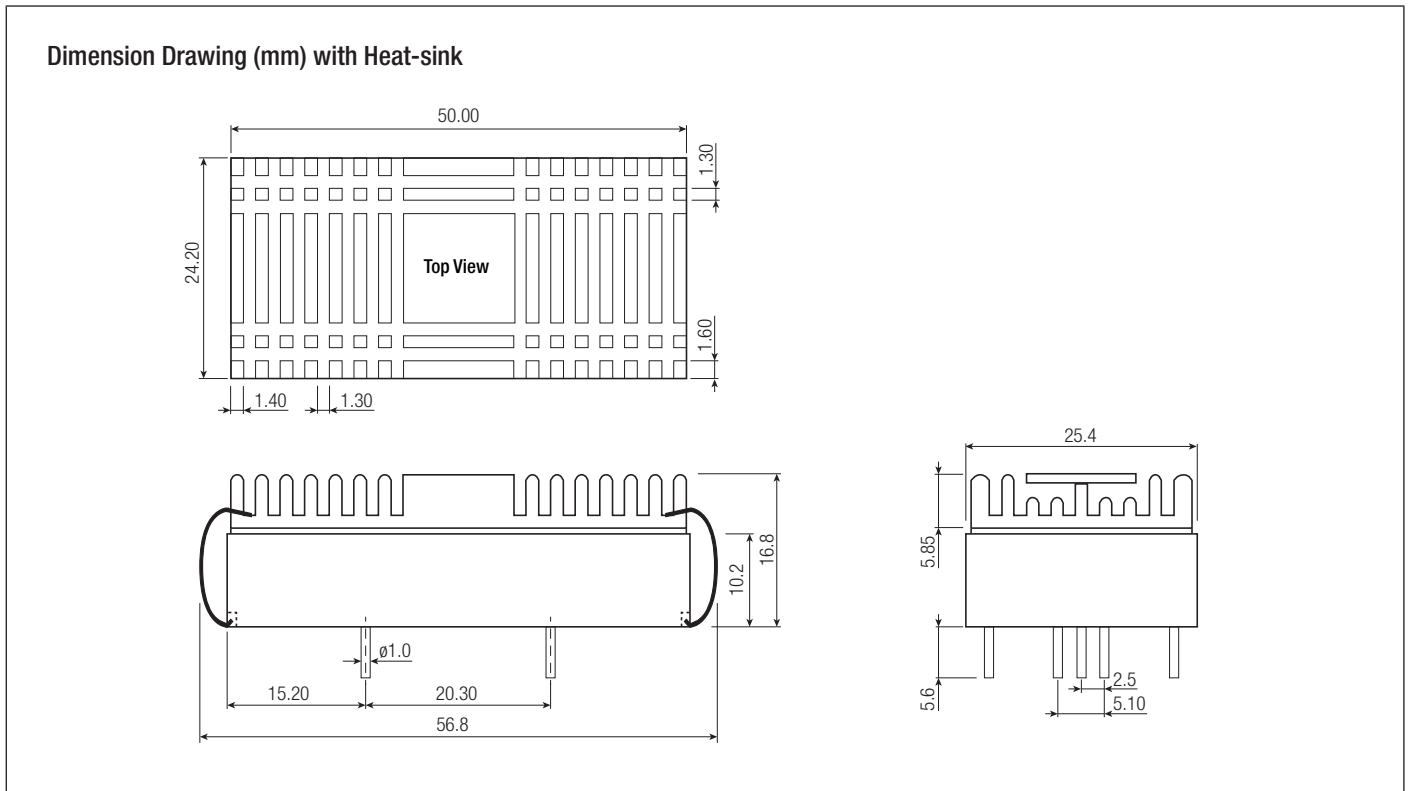

**PACKAGING INFORMATION**

Parameter	Type	Value
Packaging Dimension (LxWxH)	Tube	255 x 55 x 22mm
	Tray	302.5 x 222 x 28mm
Packaging Quantity	without Heat-sink Tube	9pcs.
	with Heat-sink Tray	20pcs.
Storage Temperature Range		-55°C to +125°C
Storage Humidity		5% - 95% RH