

Product Description

The Qorvo TGC4610-SM is a K-Band Image Reject Downconverter. The TGC4610-SM operates over an RF frequency range of 17 to 27 GHz and LO from 6.5 to 15.5 GHz with IF outputs from DC to 4 GHz. This part is designed using Qorvo's pHEMT production process.

The TGC4610-SM integrates an LNA, and image reject mixer driven by a multiplier. It typically provides an Input IP3 of 3 dBm at -25 dBm input power per tone and has a conversion gain of 15 dB and noise figure of 2.5 dB or less.

The TGC4610-SM is available in a low-cost, surface mount 28 lead 5x5 mm QFN package and is ideally suited for Point-to-Point Radio, and K-Band VSAT Ground Terminal applications.

Lead-free and RoHS compliant.

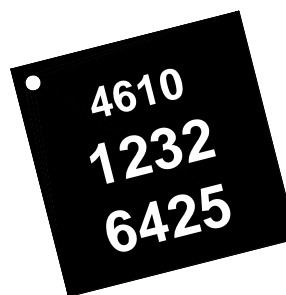

28-pin 5x5 mm QFN package

Product Features

- RF Frequency Range: 17 – 27 GHz
- IF Frequency: DC – 4 GHz
- LO Frequency: 6.5 – 15.5 GHz
- LO Input Power: 2 to 9 dBm
- Conversion Gain: 15 dB
- Noise Figure: ≤ 2.5 dB
- Package Dimensions: 5.0 x 5.0 x 1.3 mm

Performance is typical across frequency. Please reference electrical specification table and data plots for more details.

Function Block Diagram

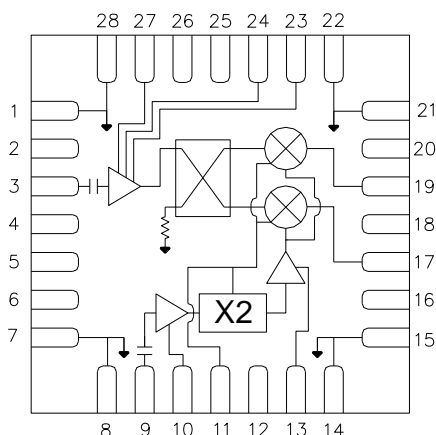

Applications

- VSAT
- Point-to-Point Radio
- Test Equipment & Sensors

Ordering Information

Part No.	Description
TGC4610-SM	K-Band Downconverter
TGC4610-SMEVB-L	1.35 - 2.45 GHz EVAL BOARD
TGC4610-SMEVB-H	2.5 - 4.0 GHz EVAL BOARD

Standard T/R size = 500 pieces on a 7" reel

Absolute Maximum Ratings

Parameter	Rating
VDLNA	6 V
VDLO	6 V
IDRF	150 mA
IDLO	375 mA
VGX, VGRF	-3 to 0 V
Power Dissipation, P _{diss}	1.6 W
RF Input Power, CW, T = 25 °C	16.7 dBm
Channel Temperature, T _{ch}	200 °C
Mounting Temperature (30 sec)	260 °C
Storage Temperature	-65 to 125 °C

These are stress ratings only, functional operation of the device at these conditions is not implied. Extended application of Absolute Maximum Rating conditions may reduce device reliability. Operation of this device outside the parameter ranges given above may cause permanent damage.

Recommended Operating Conditions

Parameter	Min	Typ.	Max	Units
Operating Temperature Range	-40	+25	+85	°C
VDRF		3		V
IDRF		68		mA
VDLO		3		V
IDLO		160		mA
VGRF		-0.65		V
VGX		-1.1		V
LO Input Power	2		9	dBm

Electrical specifications are measured at specified test conditions. Specifications are not guaranteed over all recommended operating conditions.

Electrical Specifications

Test conditions unless otherwise noted: RF Input Power = -25 dBm, LO Input Power = 5.5 dBm, VGX = -1.1 V, VDLO = 3 V, IDLO = 160 mA, VDRF = 3 V, IDRF = 68 mA., VGRF = -0.65 V

Parameter	Conditions	Min	Typ.	Max	Units
RF Frequency Range		17		27	GHz
LO Frequency Range		6.5		15.5	GHz
IF Frequency Range		DC		4	GHz
LO Input Power		2	5.5	9	dBm
Drain Current, LO (IDLO)			160		mA
Drain Current, RF (IDRF)			68		mA
Conversion Gain		11.5	15	18.5	dB
Input Third Order Intercept Point (IIP3)	18 to 24 GHz	0	3		dBm
	24 to 28 GHz	-2	2		
Image Rejection (IMR)			20		dB
Noise Figure			2.5		dB

Thermal and Reliability Information

Parameter	Conditions	Rating
Thermal Resistance, θ_{JC} , measured to back of package	$T_{base} = 85\text{ }^{\circ}\text{C}$	$\theta_{JC} = 73.5\text{ }^{\circ}\text{C/W}$
Channel Temperature (T_{ch}), and Median Lifetime (T_m)	$T_{base} = 85\text{ }^{\circ}\text{C}$, VDRF = 3 V, IDRF = 68 mA VDLO = 3 V, IDLO = 160 mA $P_{diss} = 0.68\text{ W}$	$T_{ch} = 135\text{ }^{\circ}\text{C}$ $T_m = 5.8\text{E}+6\text{ Hours}$
Channel Temperature (T_{ch}), and Median Lifetime (T_m) Under RF Drive	$T_{base} = 85\text{ }^{\circ}\text{C}$, VDRF = 3 V, IDRF = 68 mA VDLO = 3 V, IDLO = 220 mA $P_{in} = -25\text{ dBm}$, $P_{diss} = 0.68\text{ W}$	$T_{ch} = 148\text{ }^{\circ}\text{C}$ $T_m = 1.3\text{E}+6\text{ Hours}$

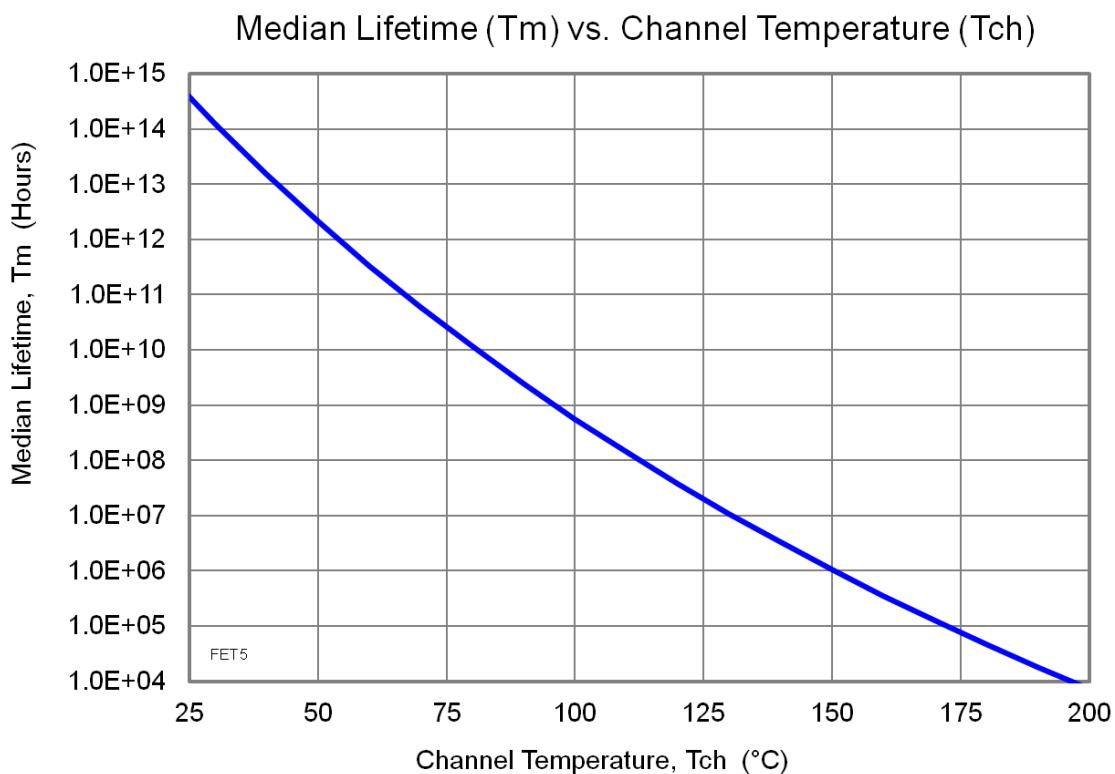

Performance Plots

RF Input Power = -25 dBm, VDLO = 3 V, IDLO = 160 mA, VDRF = 3 V, IDRF = 68 mA, VGRF = -0.65 V.
Data taken with external IF hybrid.

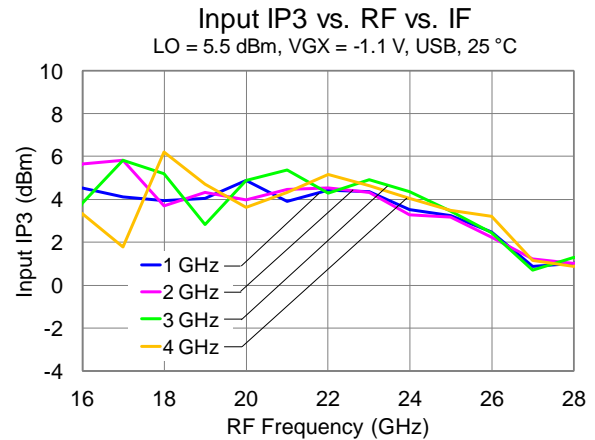
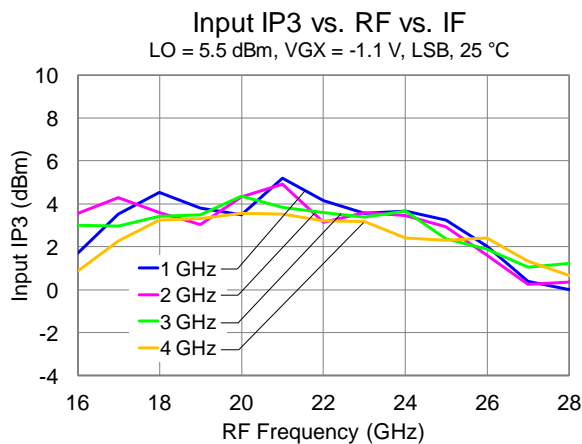
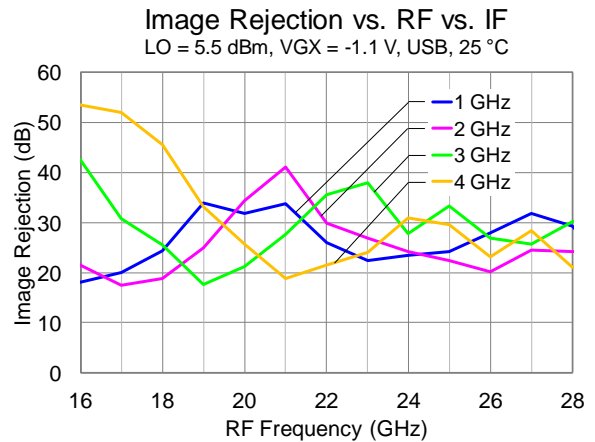
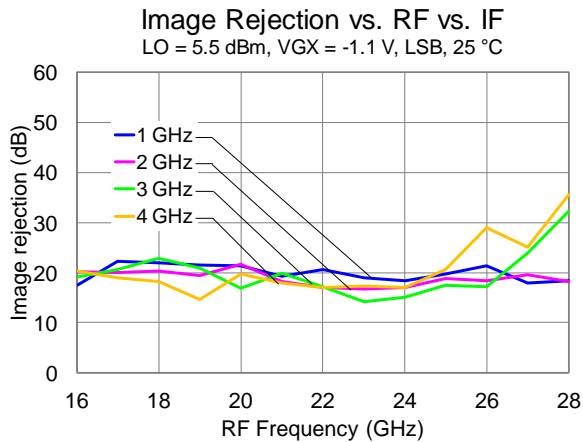
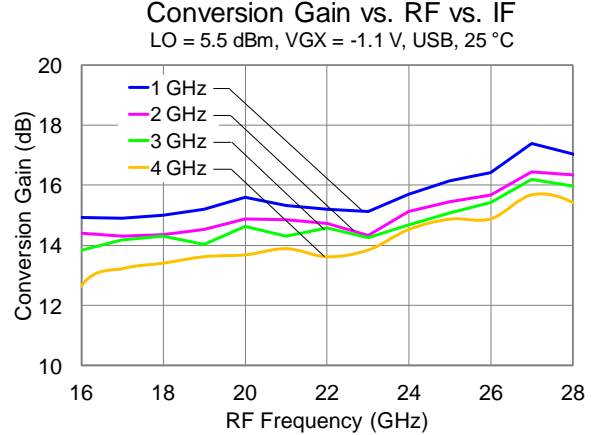
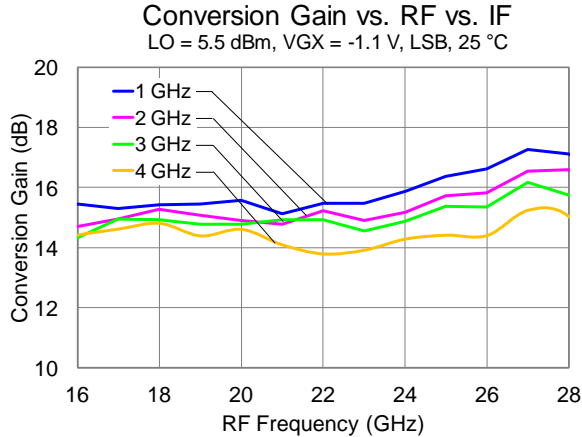

Performance Plots

RF Input Power = -25 dBm, VDLO = 3 V, IDLO = 160 mA, VDRF = 3 V, IDRF = 68 mA, VGRF = -0.65 V.
Data taken with external IF hybrid.

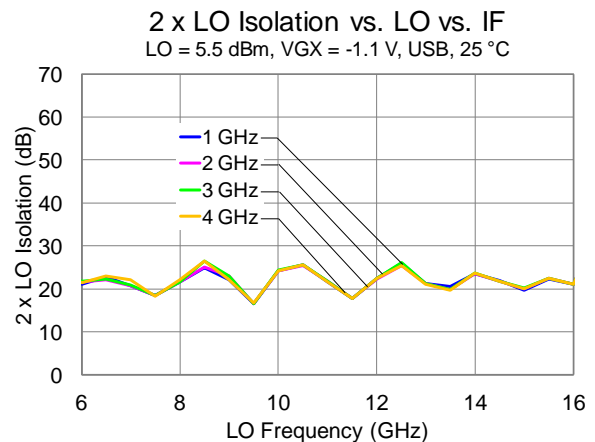
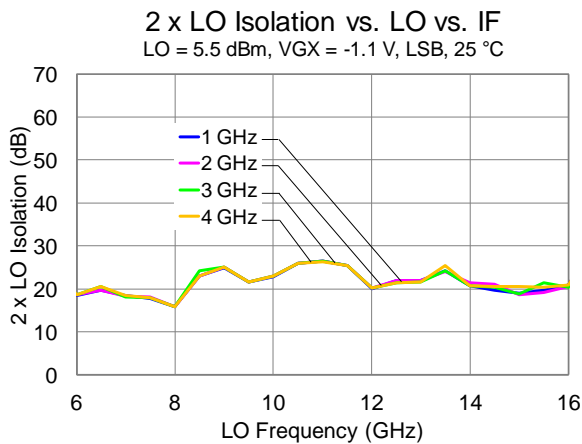
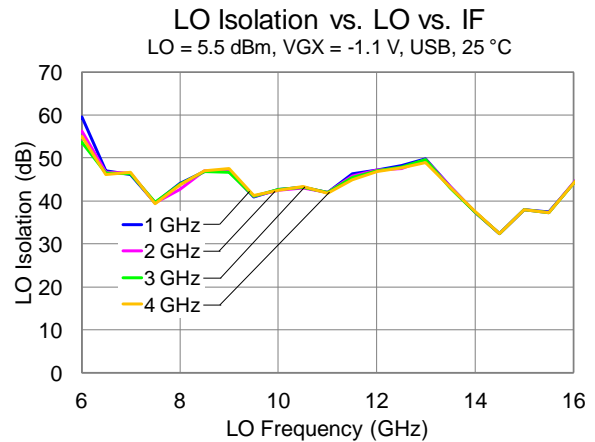
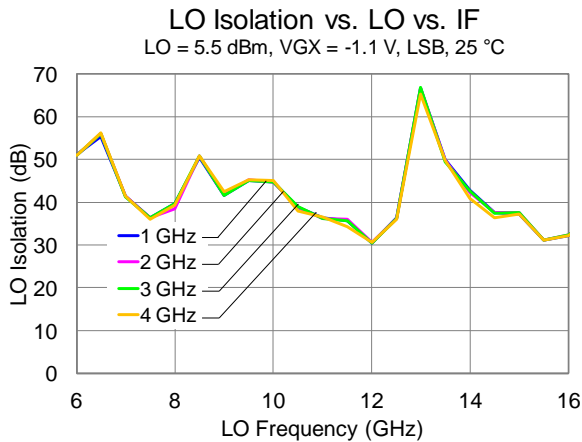
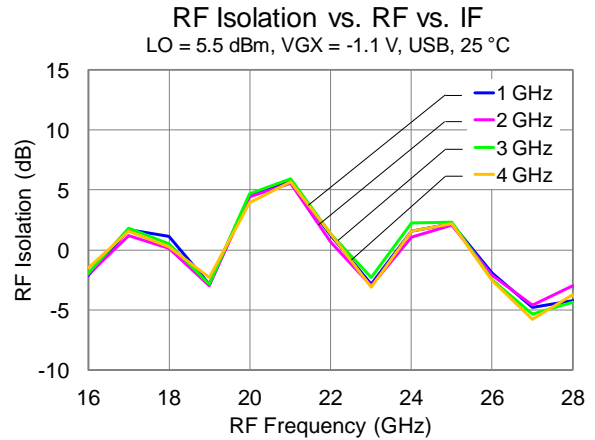
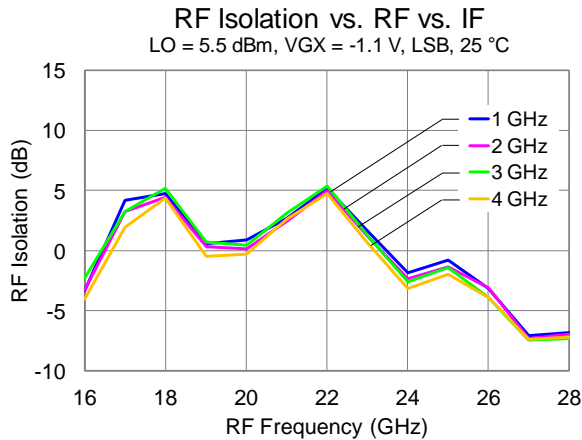

Performance Plots

RF Input Power = -25 dBm, VDLO = 3 V, IDLO = 160 mA, VDRF = 3 V, IDRF = 68 mA, VGRF = -0.65 V.
Data taken with external IF hybrid.

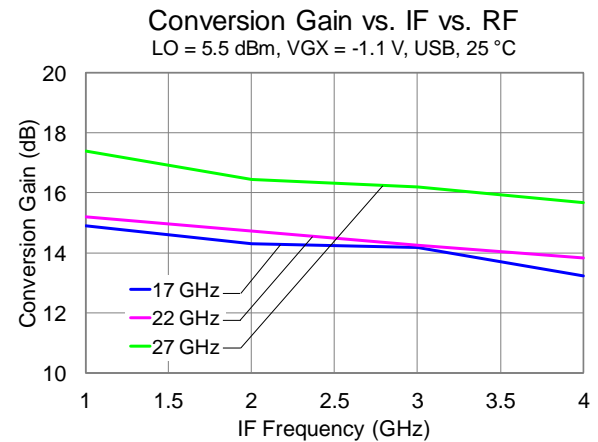
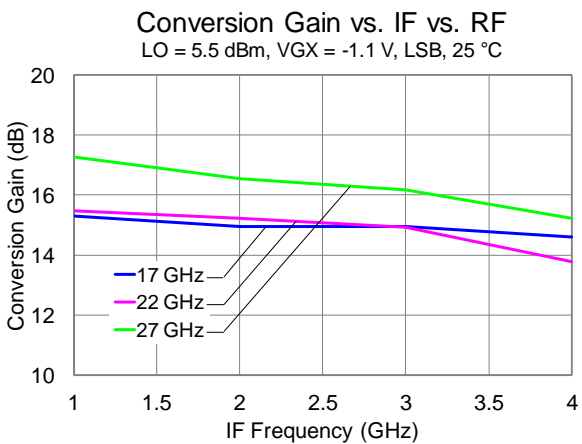
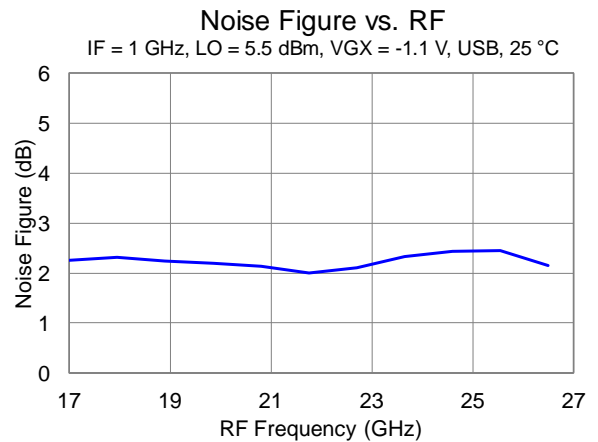
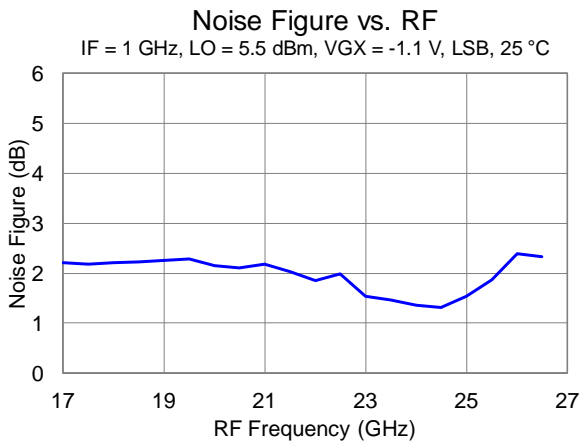
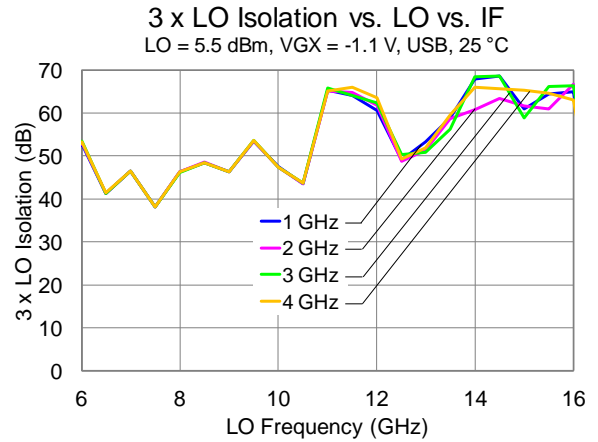
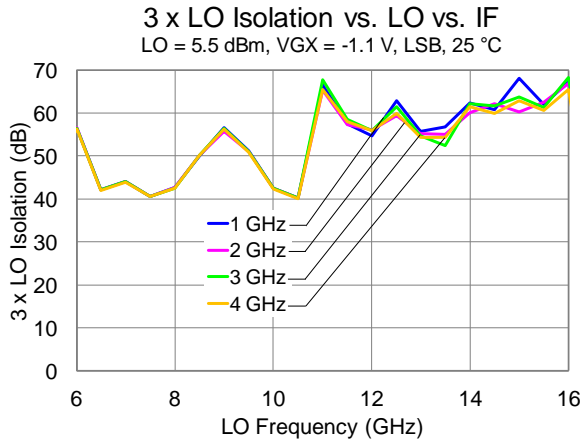

Performance Plots

RF Input Power = -25 dBm, VDLO = 3 V, IDLO = 160 mA, VDRF = 3 V, IDRF = 68 mA, VGRF = -0.65 V.
Data taken with external IF hybrid.

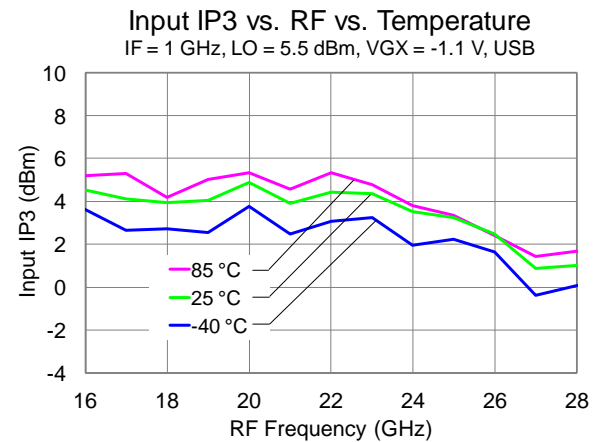
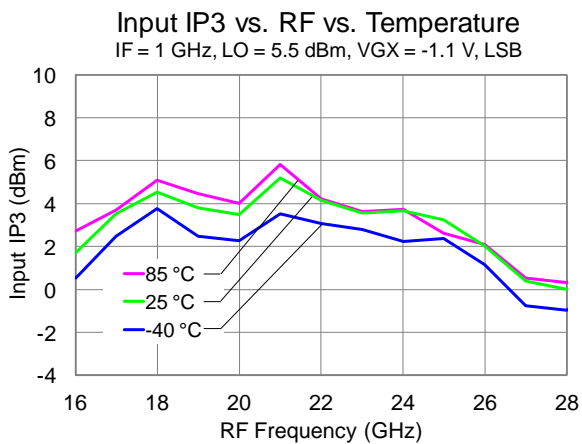
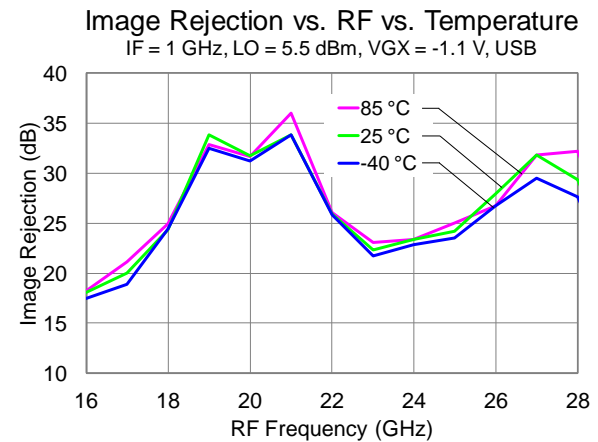
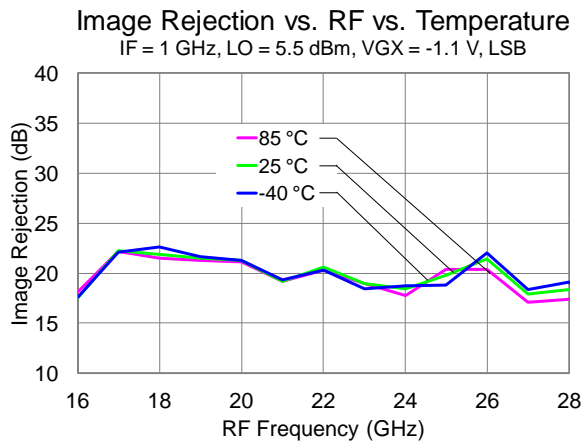
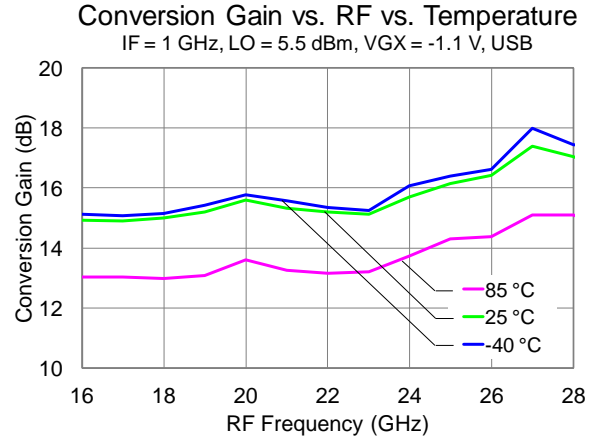
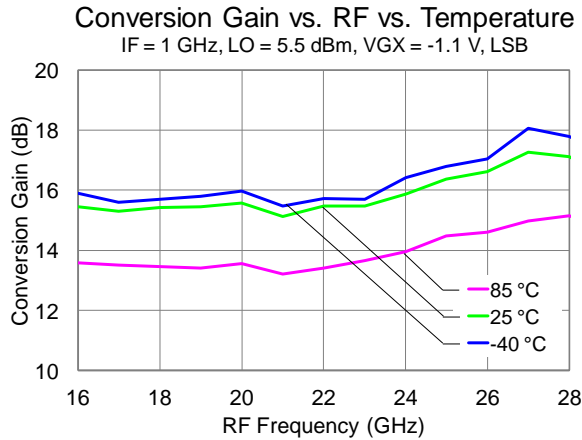

Performance Plots

RF Input Power = -25 dBm, VDLO = 3 V, IDLO = 160 mA, VDRF = 3 V, IDRF = 68 mA, VGRF = -0.65 V.
Data taken with external IF hybrid

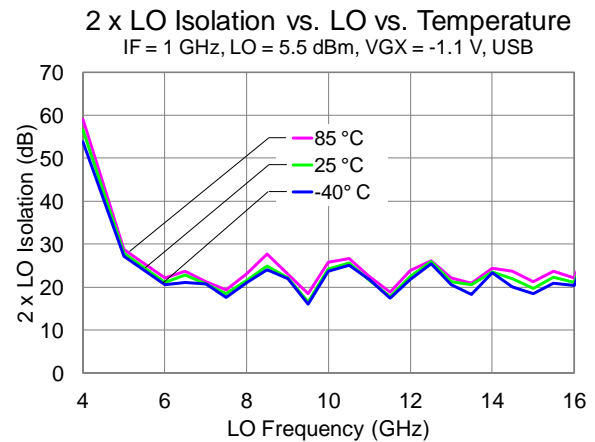
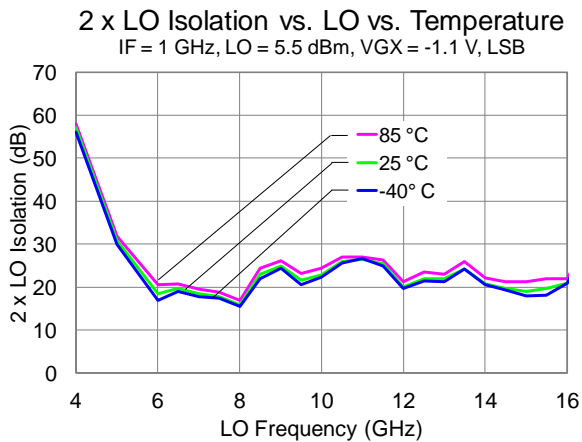
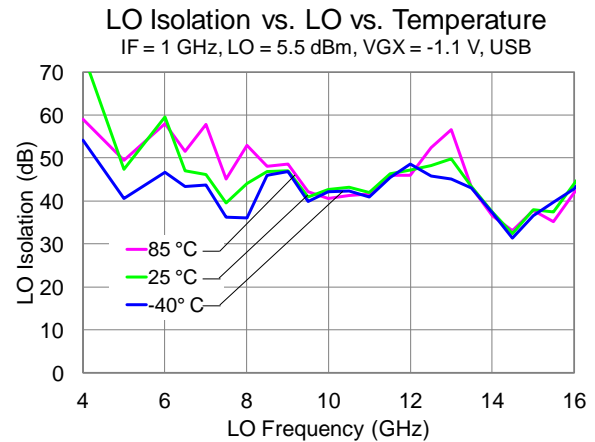
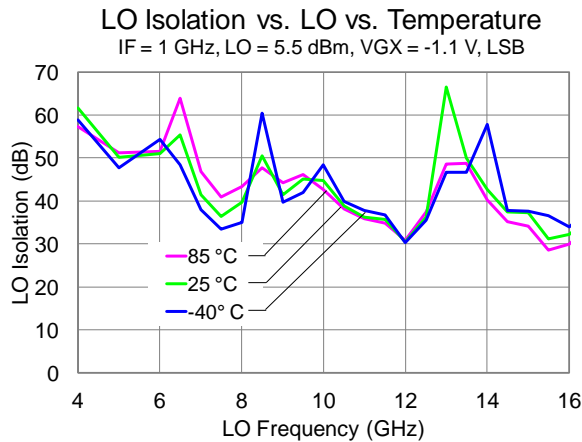
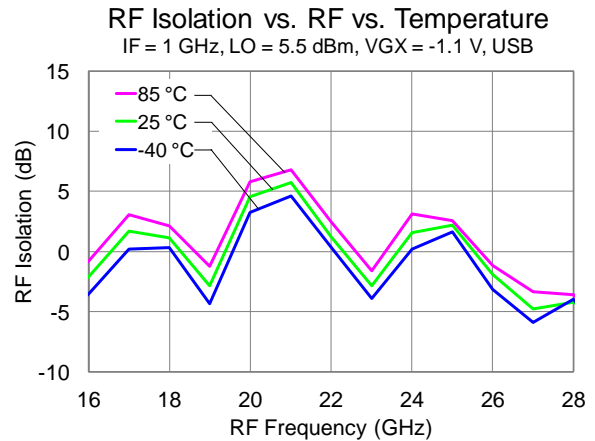
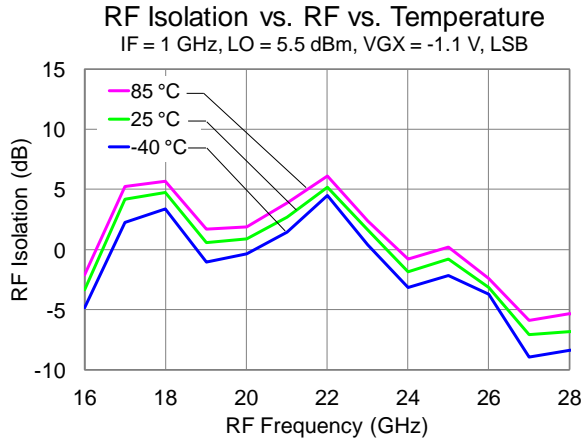

Performance Plots

RF Input Power = -25 dBm, VDLO = 3 V, IDLO = 160 mA, VDRF = 3 V, IDRF = 68 mA, VGRF = -0.65 V.
Data taken with external IF hybrid.

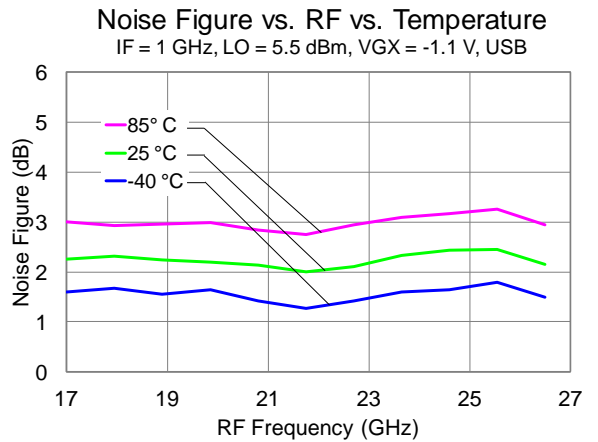
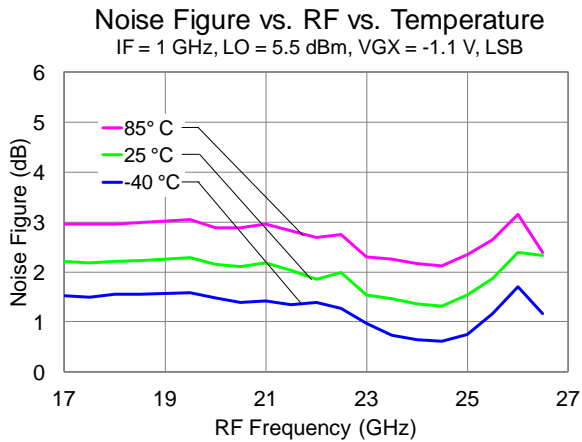
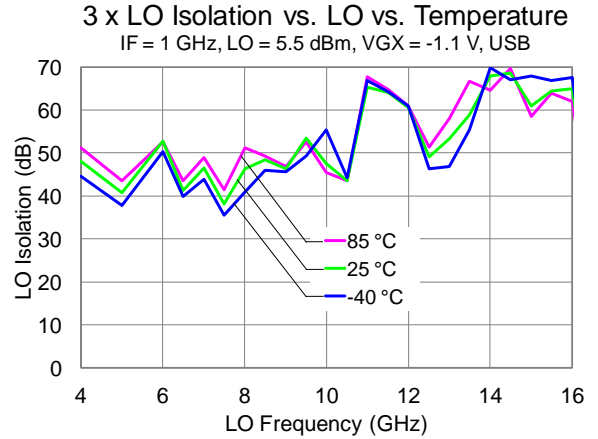
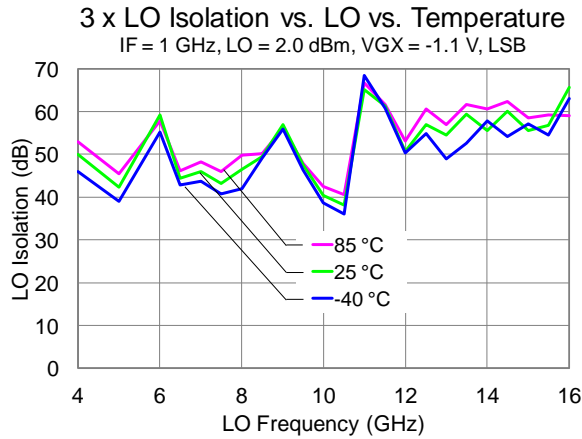

Performance Plots

RF Input Power = -25 dBm, VDLO = 3 V, IDLO = 160 mA, VDRF = 3 V, IDRF = 55 to 82 mA, VGRF = -0.7 to -0.6V.
Data taken with external IF hybrid.

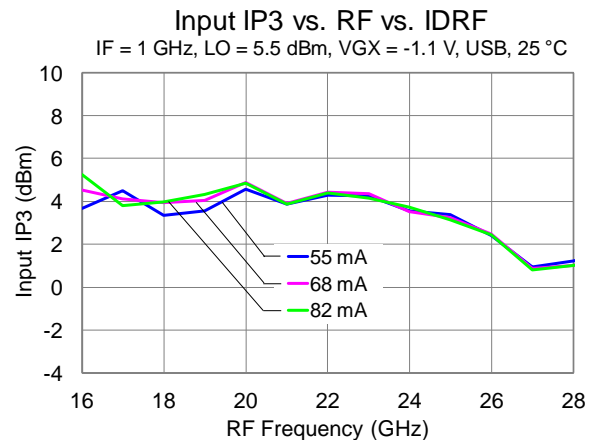
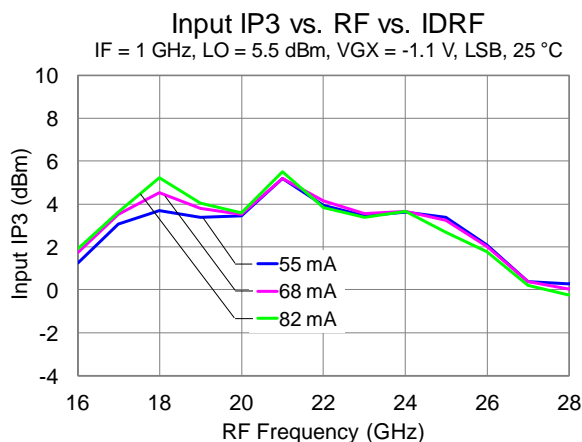
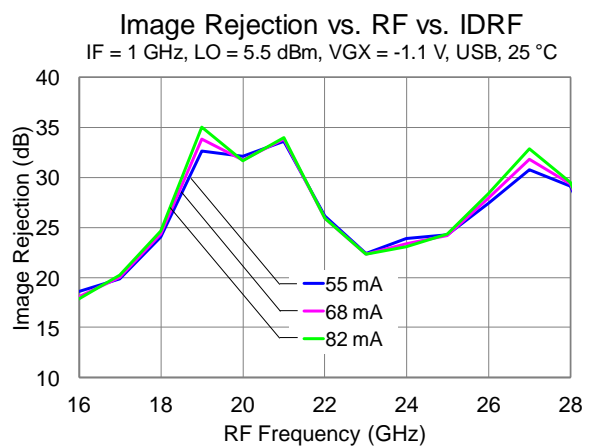
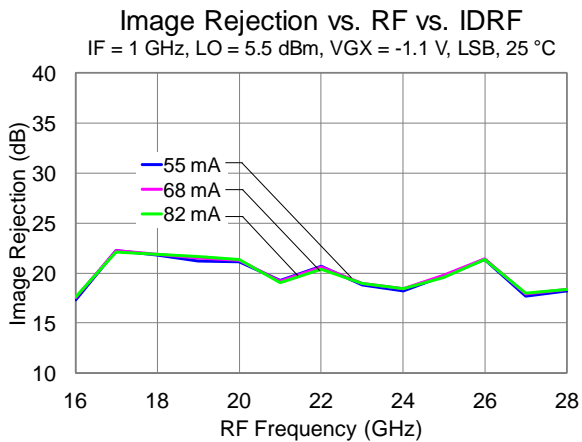
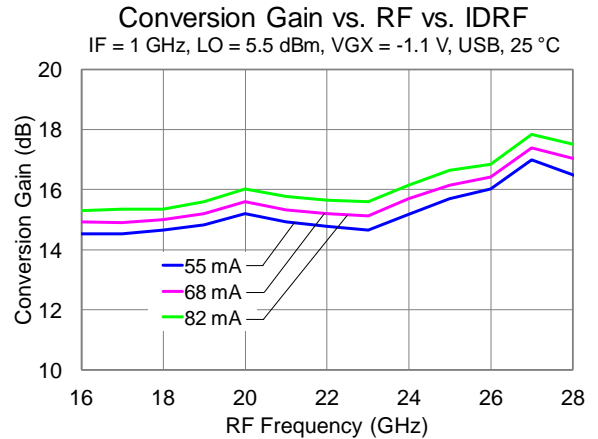
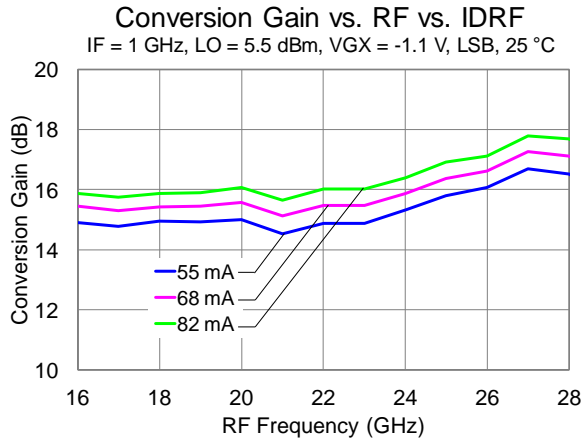

Performance Plots

RF Input Power = -25 dBm, VDLO = 3 V, IDLO = 160 mA, VDRF = 3 V, IDRF = 55 to 82 mA, VGRF = -0.7 to -0.6V.
Data taken with external IF hybrid.

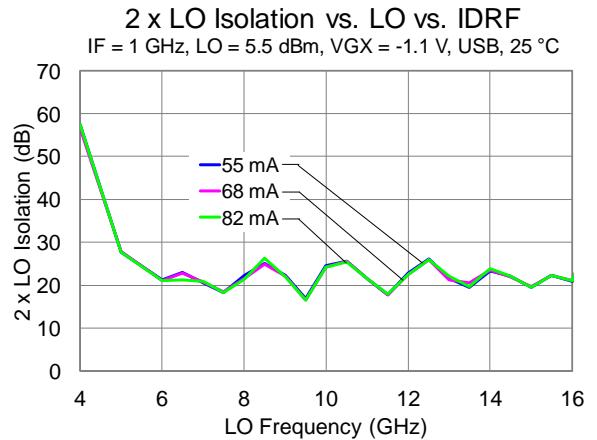
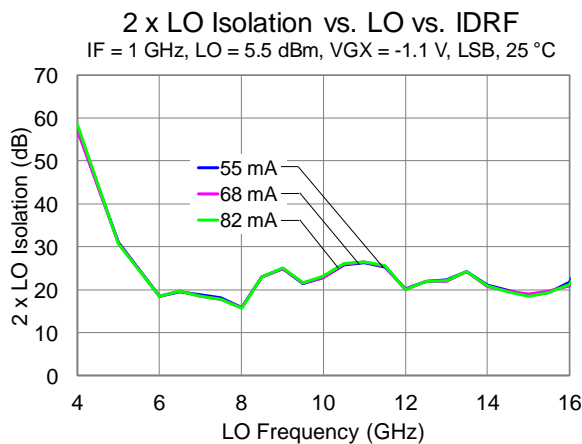
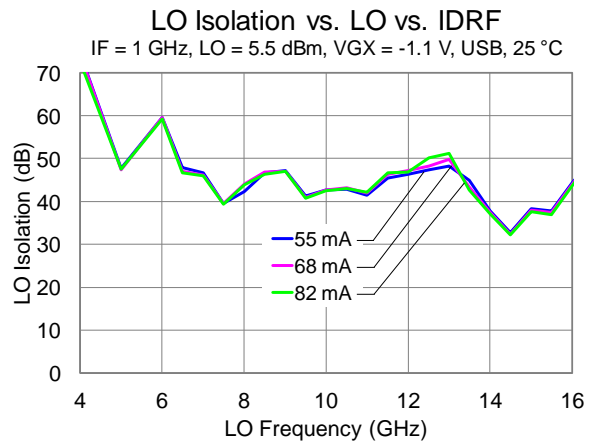
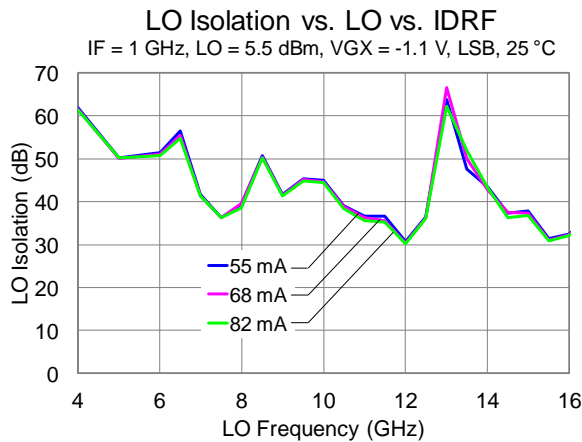
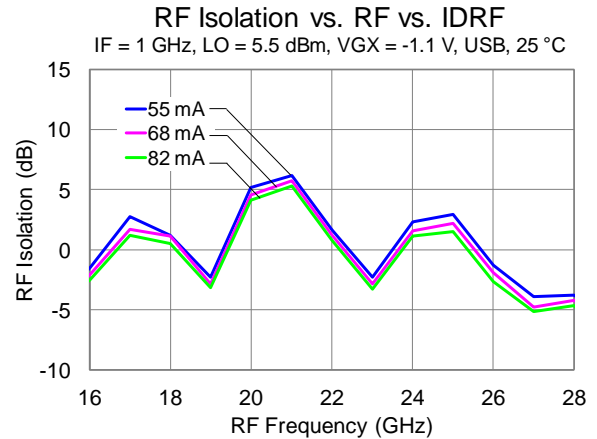
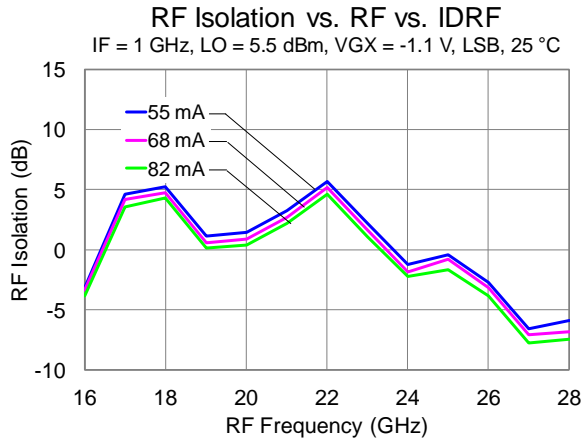

Performance Plots

RF Input Power = -25 dBm, VDLO = 3 V, IDLO = 160 mA, VDRF = 3 V, IDRf = 55 to 82 mA, VGRF = -0.7 to -0.6V.
Data taken with external IF hybrid.

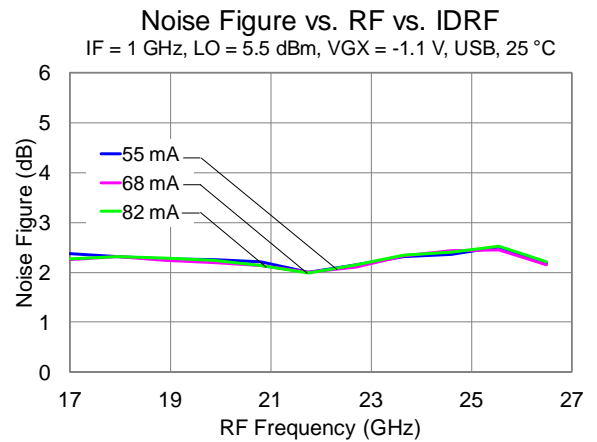
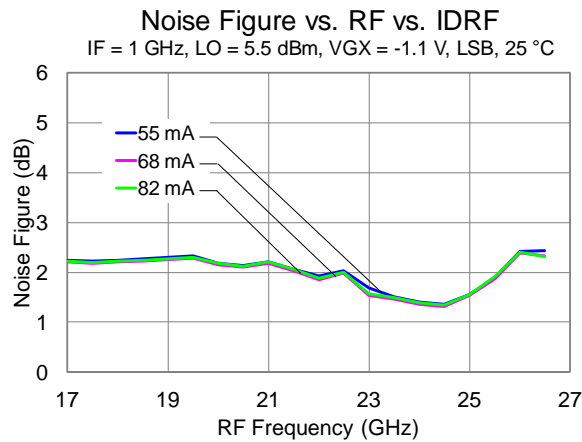
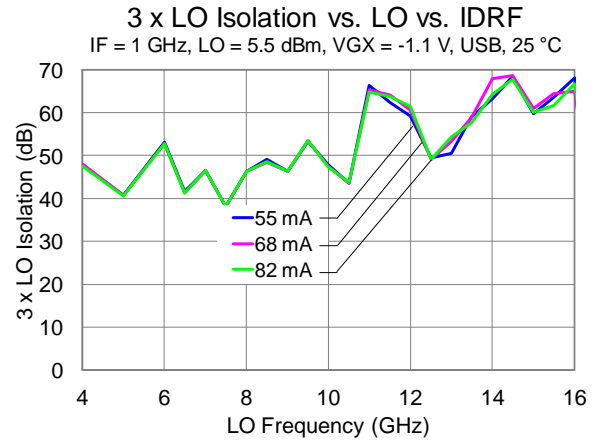
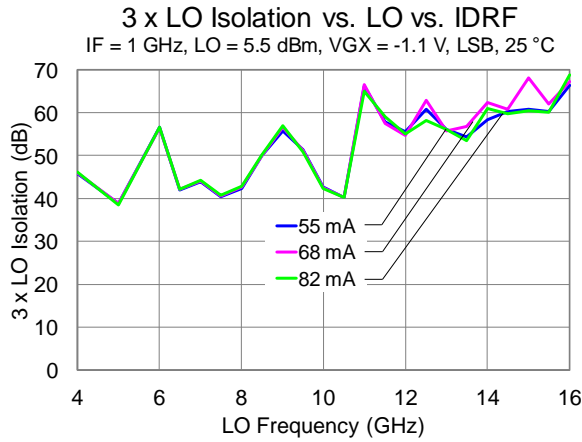

Performance Plots

RF Input Power = -25 dBm, VDLO = 3 V, IDLO = 160 mA, VDRF = 3 V, IDRF = 68 mA, VGRF = -0.65 V.
Data taken with external IF hybrid.

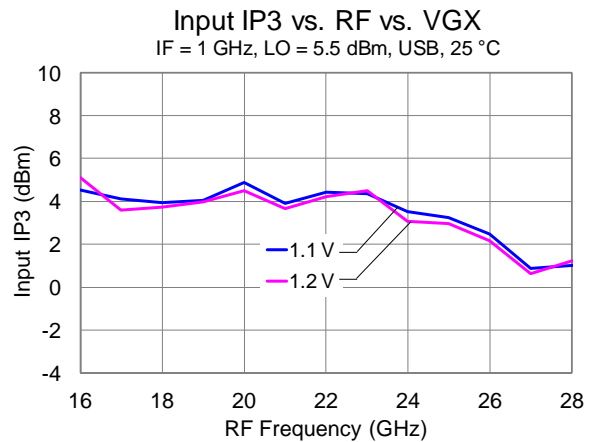
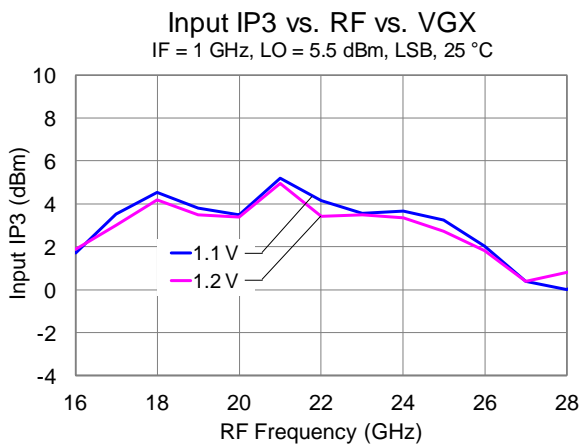
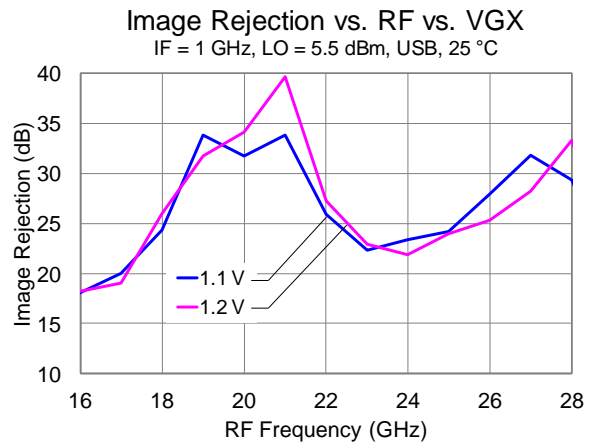
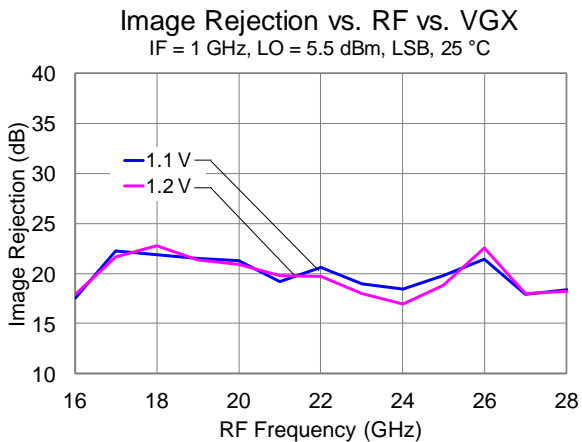
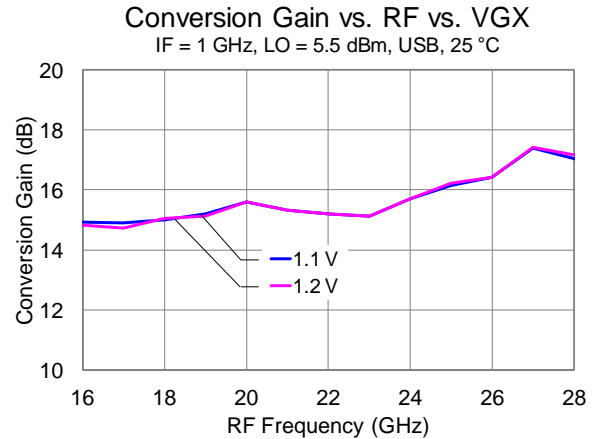
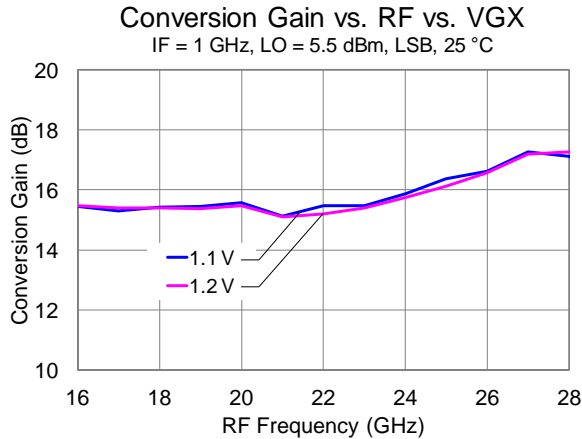

Performance Plots

RF Input Power = -25 dBm, VDLO = 3 V, IDLO = 160 mA, VDRF = 3 V, IDRF = 68 mA, VGRF = -0.65 V.
Data taken with external IF hybrid.

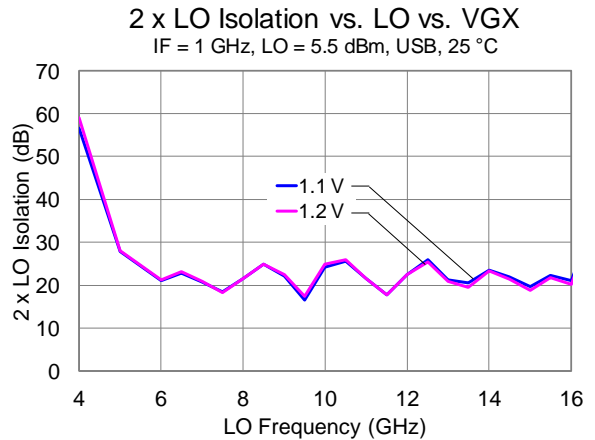
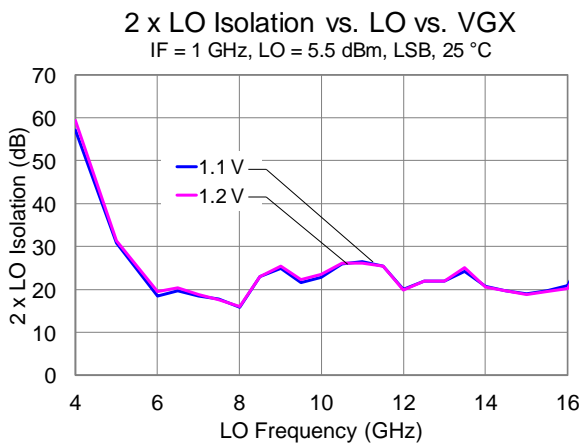
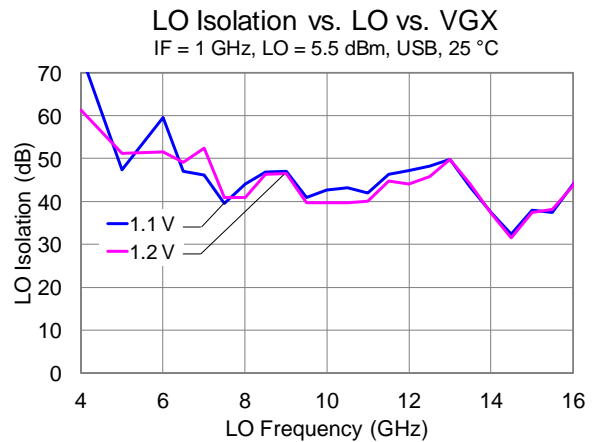
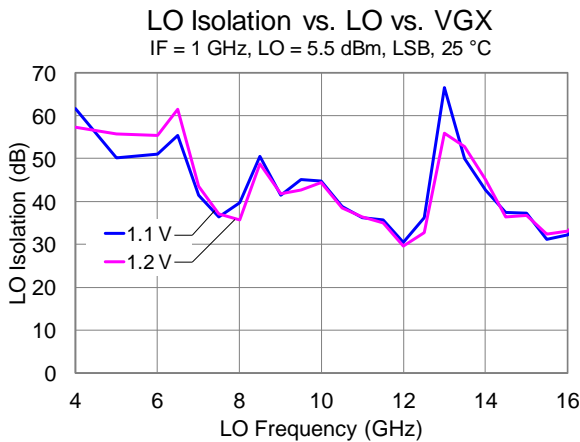
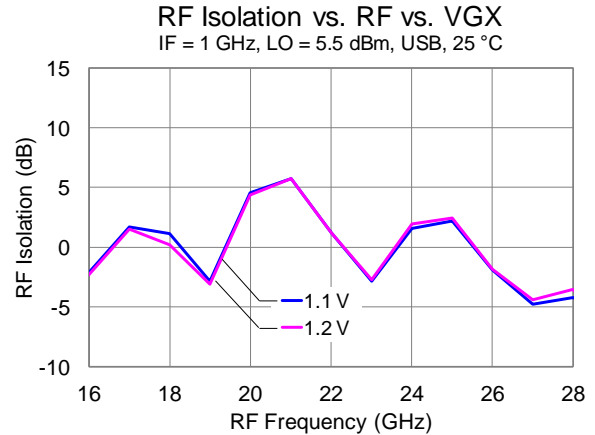
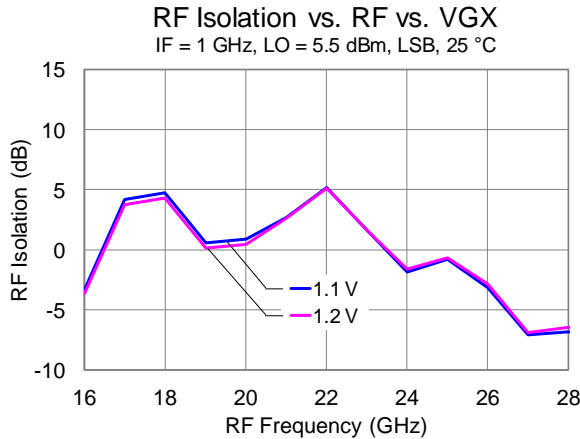

Performance Plots

RF Input Power = -25 dBm, VDLO = 3 V, IDLO = 160 mA, VDRF = 3 V, IDRf = 68 mA, VGRF = -0.65 V.
Data taken with external IF hybrid.

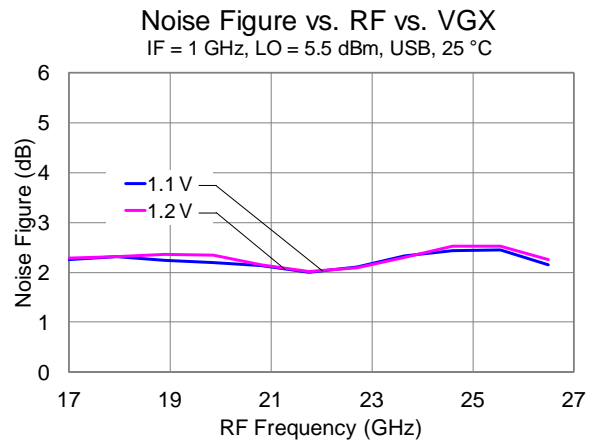
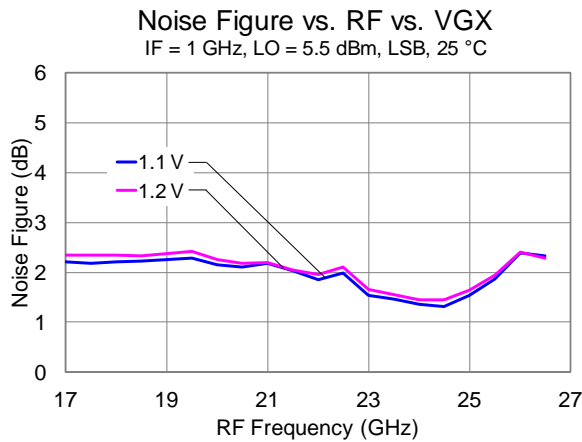
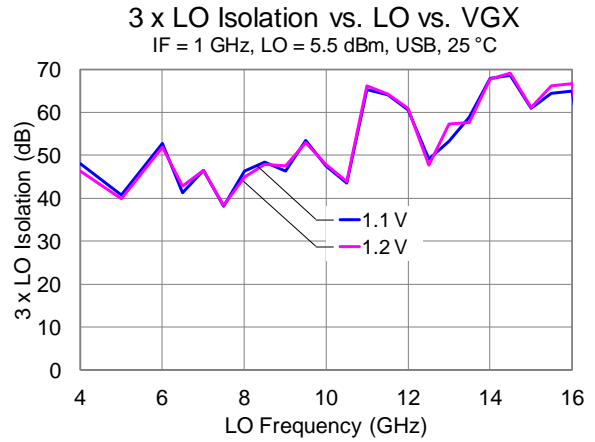
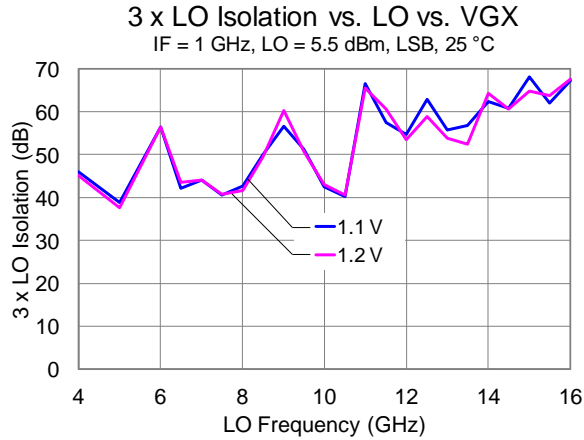

Performance Plots

RF Input Power = -25 dBm, VDLO = 3 V, IDLO = 160 mA, VDRF = 3 V, IDRF = 68 mA, VGRF = -0.65 V.
Data taken with external IF hybrid.

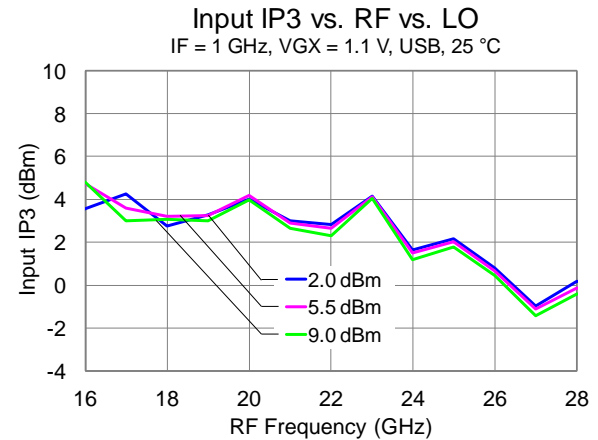
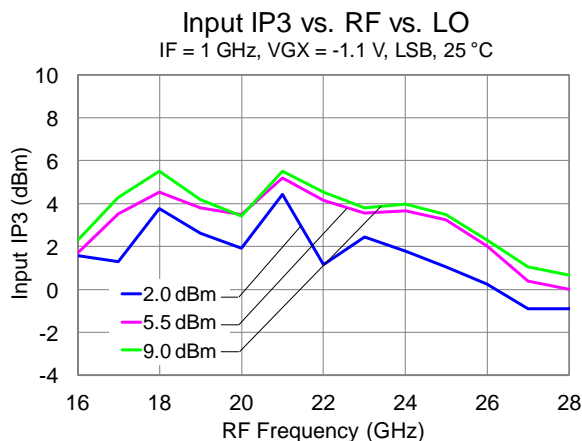
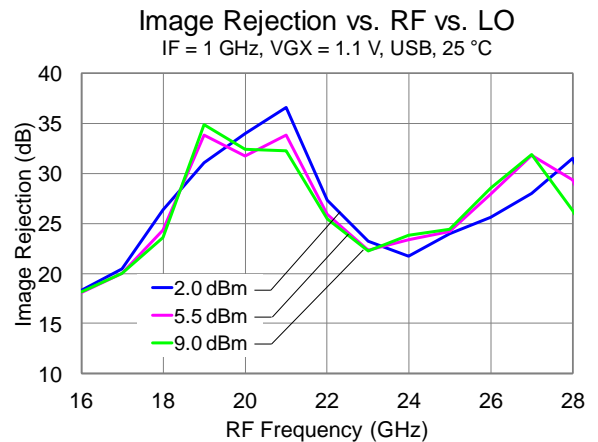
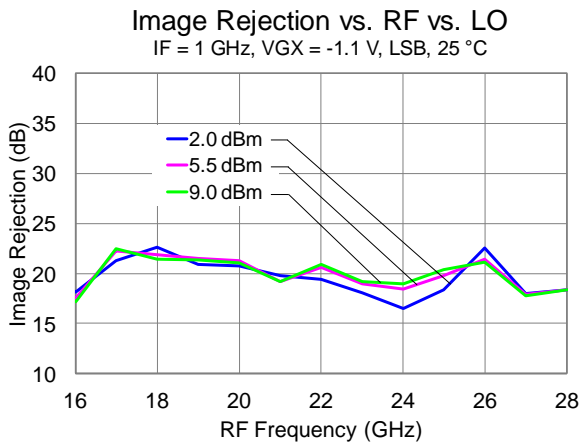
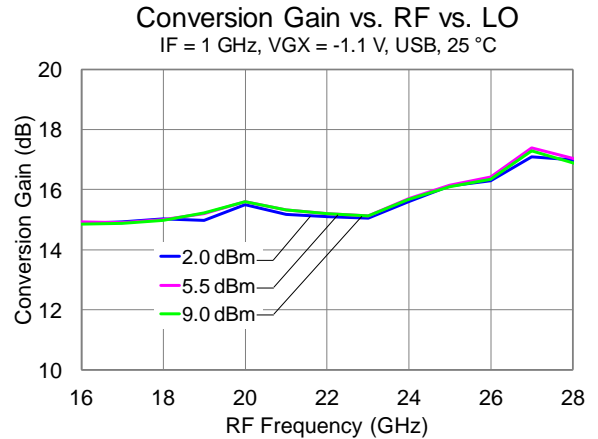
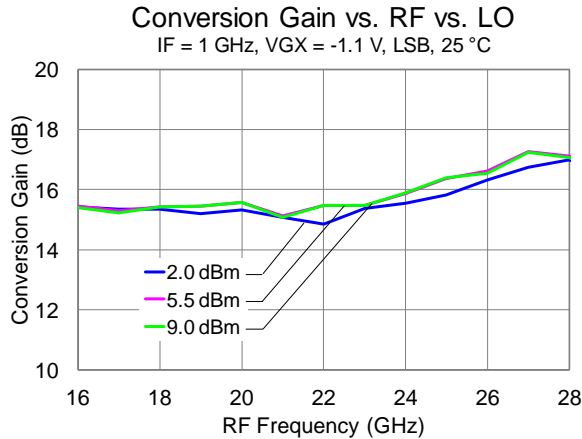

Performance Plots

RF Input Power = -25 dBm, VDLO = 3 V, IDLO = 160 mA, VDRF = 3 V, IDRF = 68 mA, VGRF = -0.65 V.
Data taken with external IF hybrid.

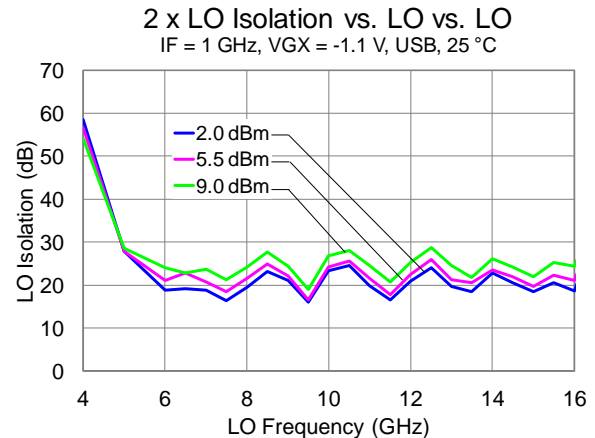
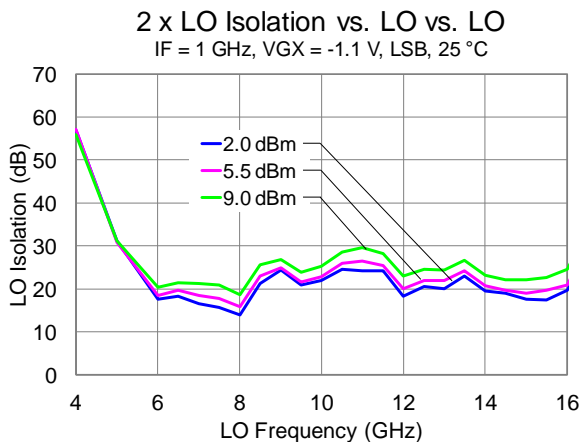
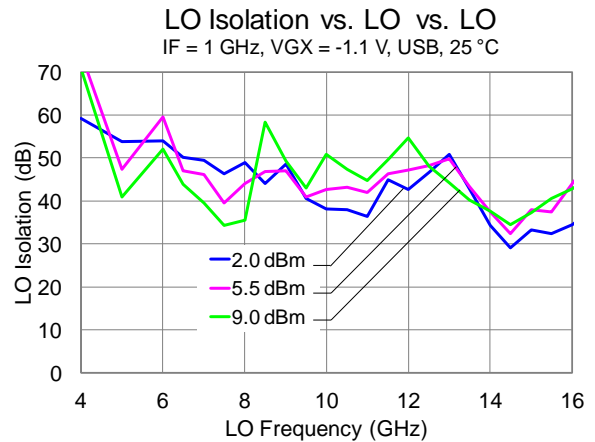
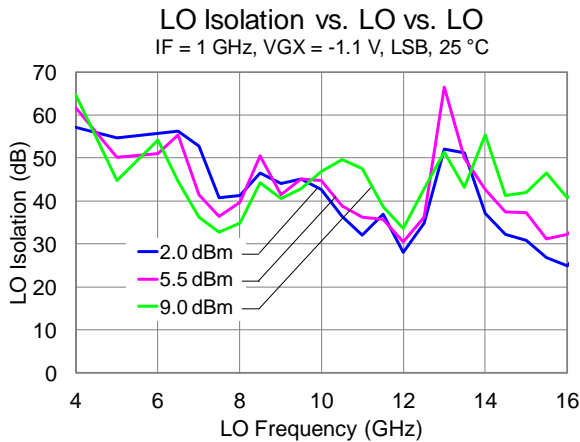
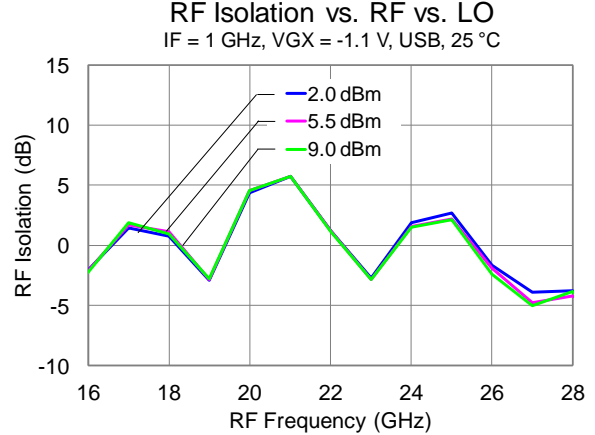
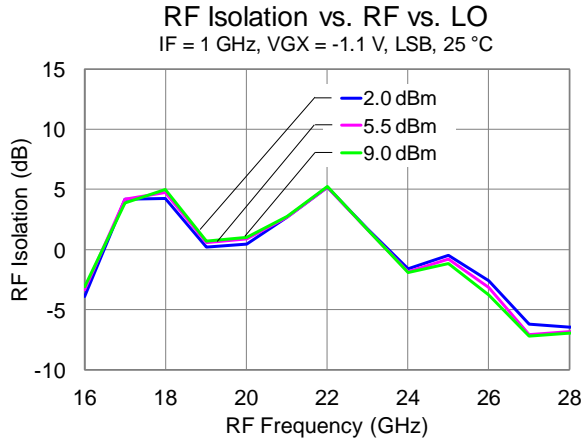

Performance Plots

RF Input Power = -25 dBm, VDLO = 3 V, IDLO = 160 mA, VDRF = 3 V, IDRF = 68 mA, VGRF = -0.65 V.
Data taken with external IF hybrid.

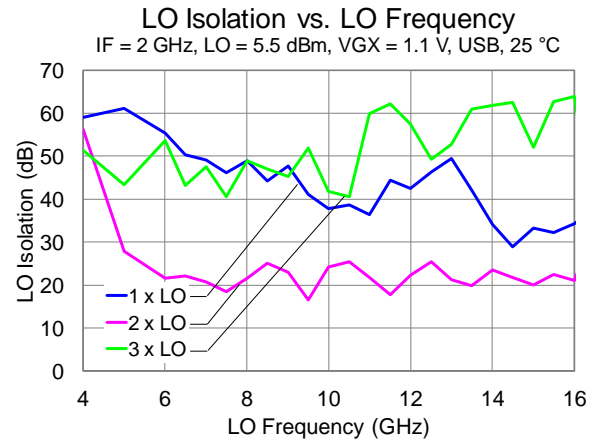
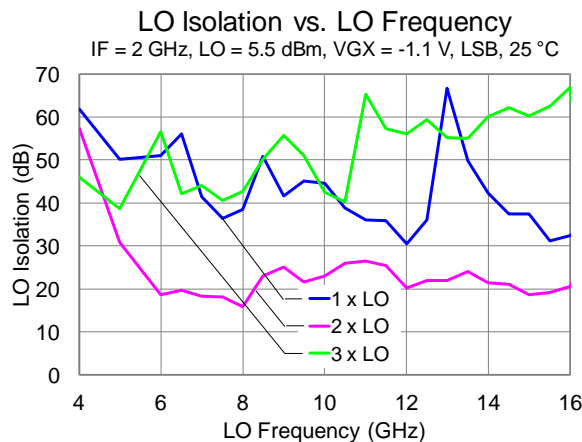
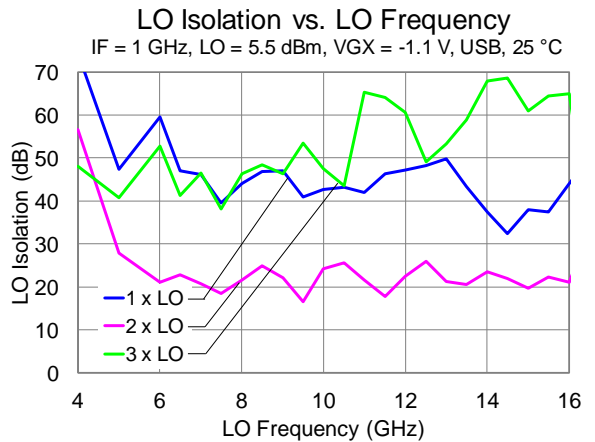
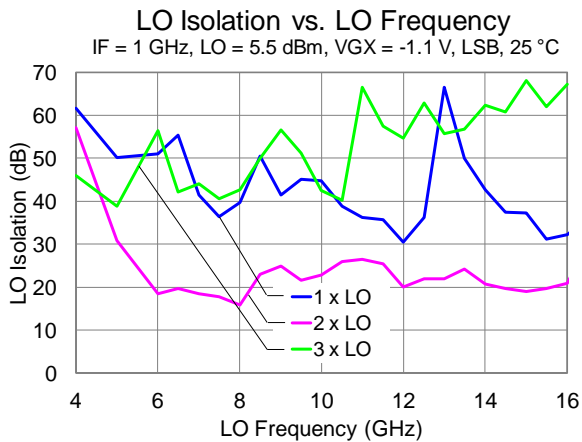
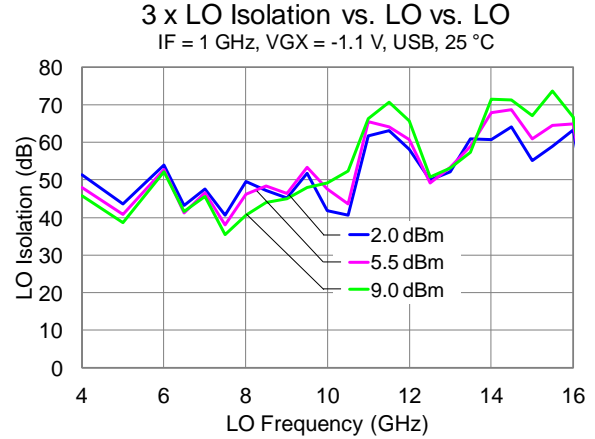
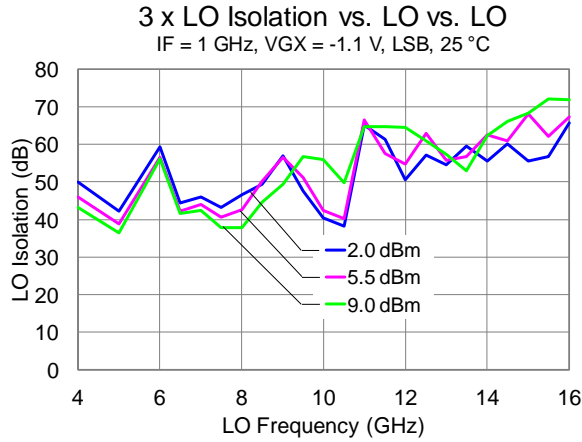

Performance Plots

RF Input Power = -25 dBm, VDLO = 3 V, IDLO = 160 mA, VDRF = 3 V, IDRF = 68 mA, VGRF = -0.65 V.
Data taken with external IF hybrid.

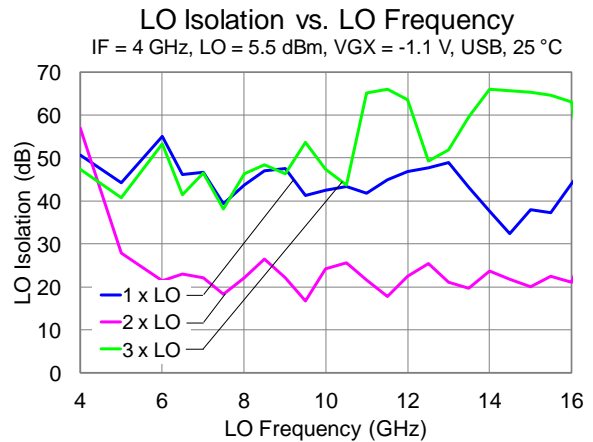
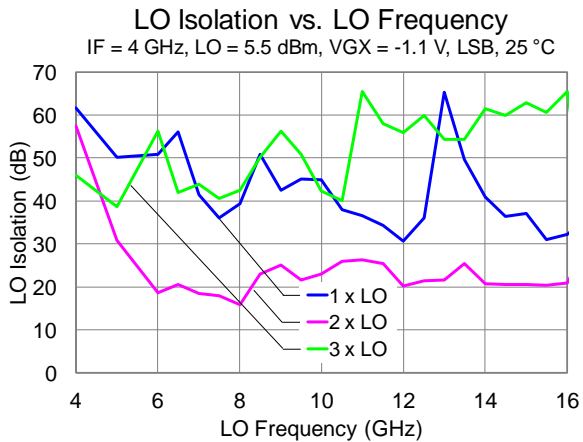
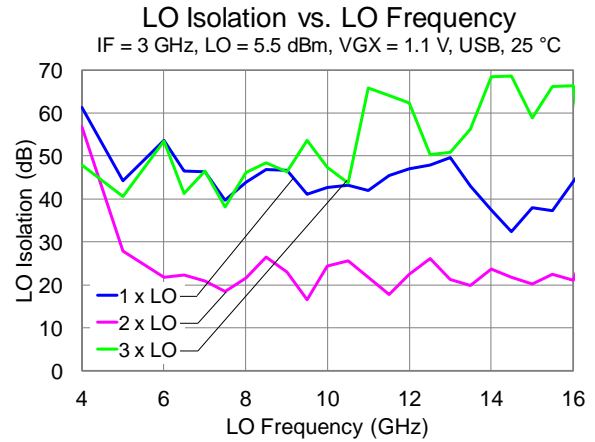
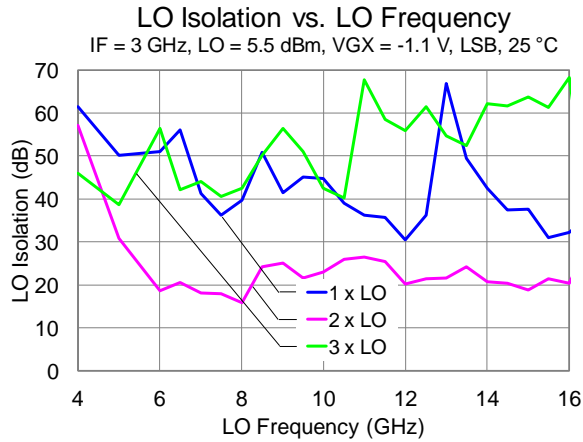

M x N Spurious Outputs for USB

IF = 2.0 GHz; RF = 17 - 27 GHz; LO = 7.5 - 12.5 GHz				
RF/LO	0	1	2	3
-3	---	49	52	51
-2	---	56	57	63
-1	---	28	0	26
0	---	12	0	14
1	10	44	23	47
2	52	50	51	---

IF = 4.0 GHz; RF = 17 - 27 GHz; LO = 6.5 - 11.5 GHz				
RF/LO	0	1	2	3
-3	---	47	50	---
-2	---	53	56	56
-1	---	30	0	32
0	---	10	-2	13
1	10	39	21	49
2	51	51	51	---

Pin Configuration and Description

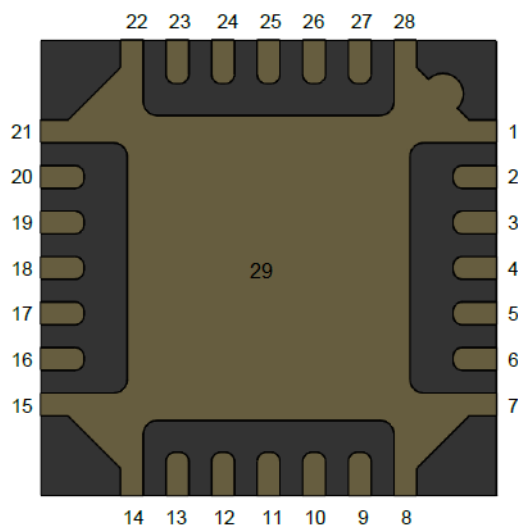

Pin	Symbol	Description
1, 2, 4-8, 12, 14-16, 20- 22, 25, 26, 28	NC	No Internal connection; must be grounded on PCB.
3	RF IN	RF Input matched to 50 ohms, AC Coupled.
9	LO IN	LO Input, matched to 50 ohms, AC coupled.
10	VDLO1	LO Drain Voltage. Bias network is required; see Application Circuit on page 21 as an example.
11	VGX / (VG_LO123)	Mixer Gate Voltage. Bias network is required; see Application Circuit on page 21 as an example.
13	VDLO23	LO Drain Voltage. Bias network is required; see Application Circuit on page 21 as an example.
17	IF1 (USB)	IF Output matched to 50 ohms, DC coupled.
18	NC	No internal connection; should be left open.
19	IF2 (LSB)	IF Output matched to 50 ohms, DC coupled.
23	VDRF4V	RF Drain Voltage for 4 V operation. Bias network is required; see Application Circuit on page 21 as an example.
24	VDRF3V	RF Drain Voltage for 3 V. Bias network is required; see Application Circuit on page 21 as an example.
27	VGRF	RF Gate Voltage. Bias network is required; see Application Circuit on page 21 as an example.
29	GND	Backside Paddle. Multiple vias should be employed to minimize inductance and thermal resistance; see Mounting Configuration on page 24 for suggested footprint.

Applications Circuit

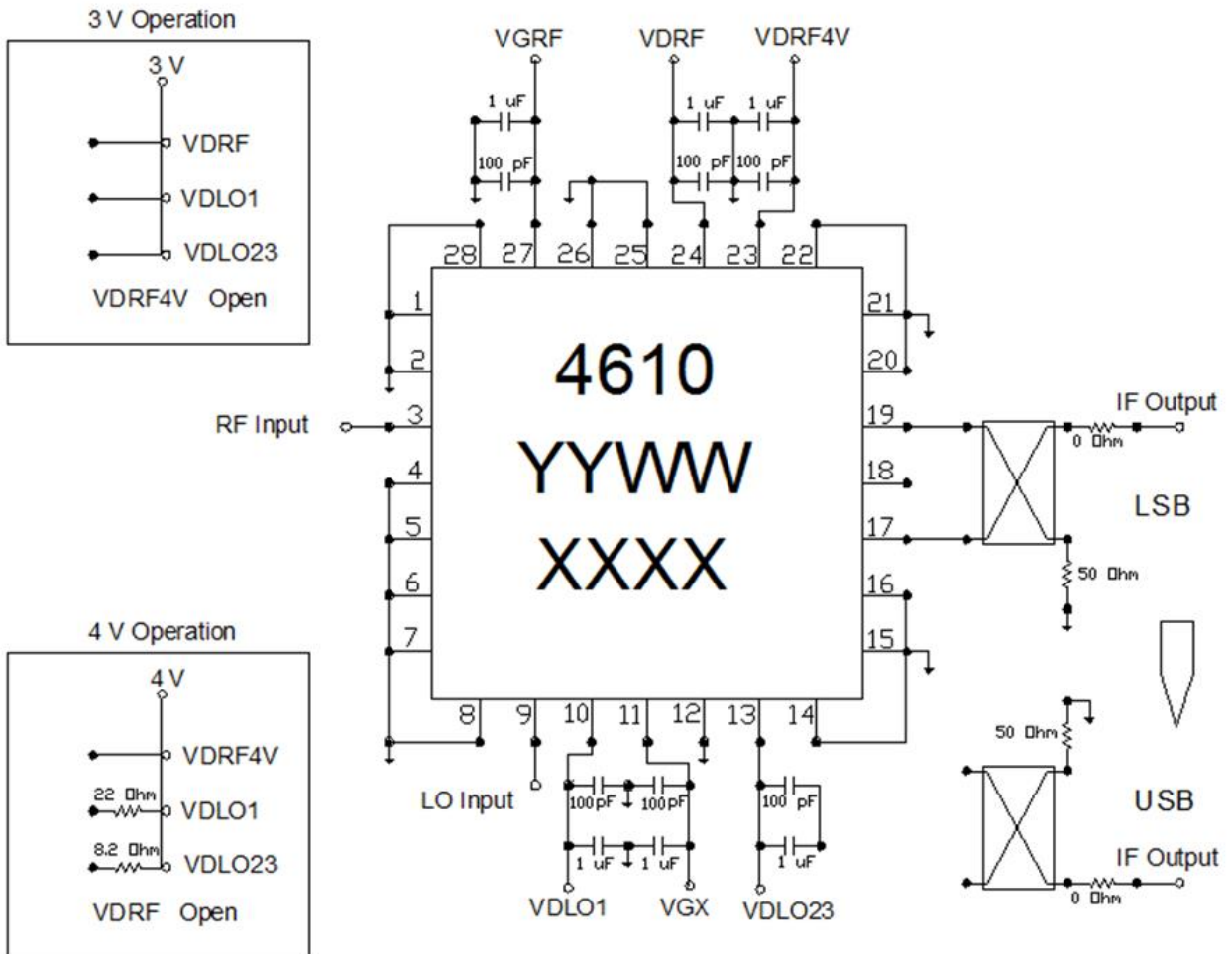

Bias-up Procedure

- Set VGX to -1.1 V
- Set VDLO to 3 V
- Set VGRF to -1.5 V
- Set VDRF to 3 V
- Increase VGRF to get IDR_F = 68 mA
- Apply LO and RF signals

Bias-down Procedure

- Turn off RF and LO signals
- Set VDRF to 0 V
- Set VDLO to 0 V
- Set VGRF to 0 V
- Set VGRF to -1.5 V

Evaluation Board (EVB) Assembly Layout

Board material is RO4003 0.014" thickness with ½ oz copper cladding.

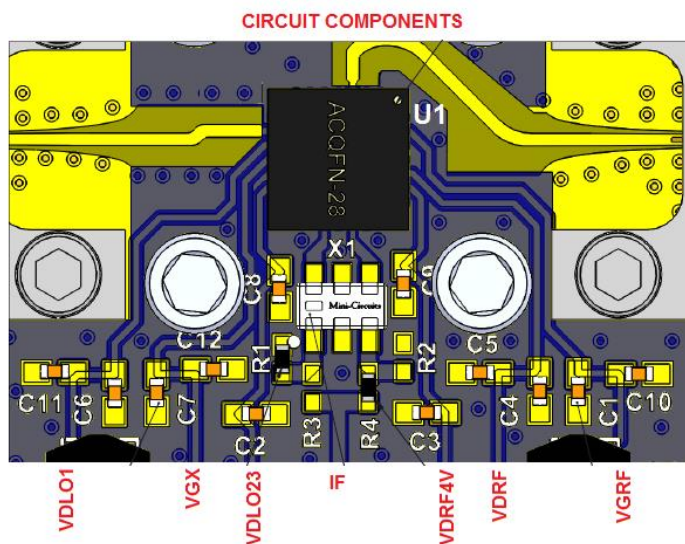
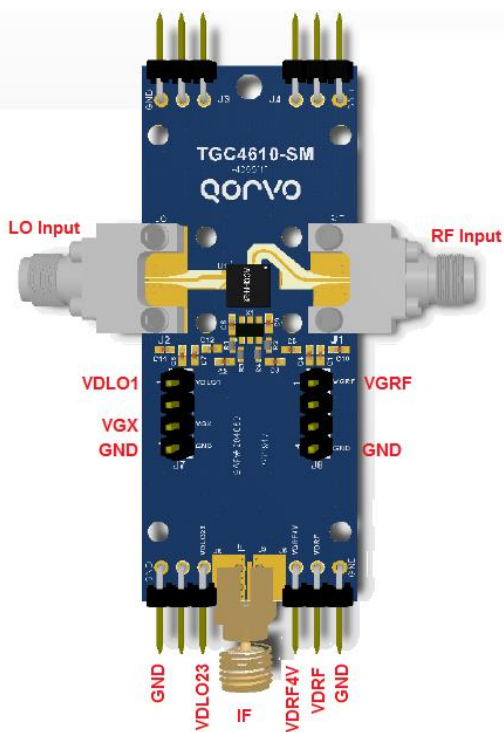

Bill of Material

Ref Des	Value	Description	Manufacturer	Part Number
C1 – C6	100 pF	Cap, 0603, 200V, 5%, NPO	various	
C7 – C12	1 µF	Cap, 0603, 50V, 10%, X7R	various	
X1		Power Splitter	Mini-circuits	QCN-25+ or QCN-45+
U1		K-Band Downconverter	Qorvo	TGC4610-SM

LSB Configuration

R1	50 Ω	Res, 0402, 0.05W, 5%, SMD	various	
R4	0 Ω	Res, 0402, 0.01W, SMD	various	
R2, R3		DNP		

USB Configuration

R2	50 Ω	Res, 0402, 0.05W, 5%, SMD	various	
R3	0 Ω	Res, 0402, 0.01W, SMD	various	
R1, R4		DNP		

Note: For 4 V operation, VDLO1 is connected to 22Ω and VDLO23 is connected to 8.2 Ω.

Assembly Notes

Compatible with lead-free soldering processes with 260°C peak reflow temperature.

This package is air-cavity and non-hermetic, and therefore cannot be subjected to aqueous washing. The use of no-clean solder to avoid washing after soldering is highly recommended.

Contact plating: Ni-Pd-Au.

Solder rework not recommended.

Recommended Soldering Temperature Profile

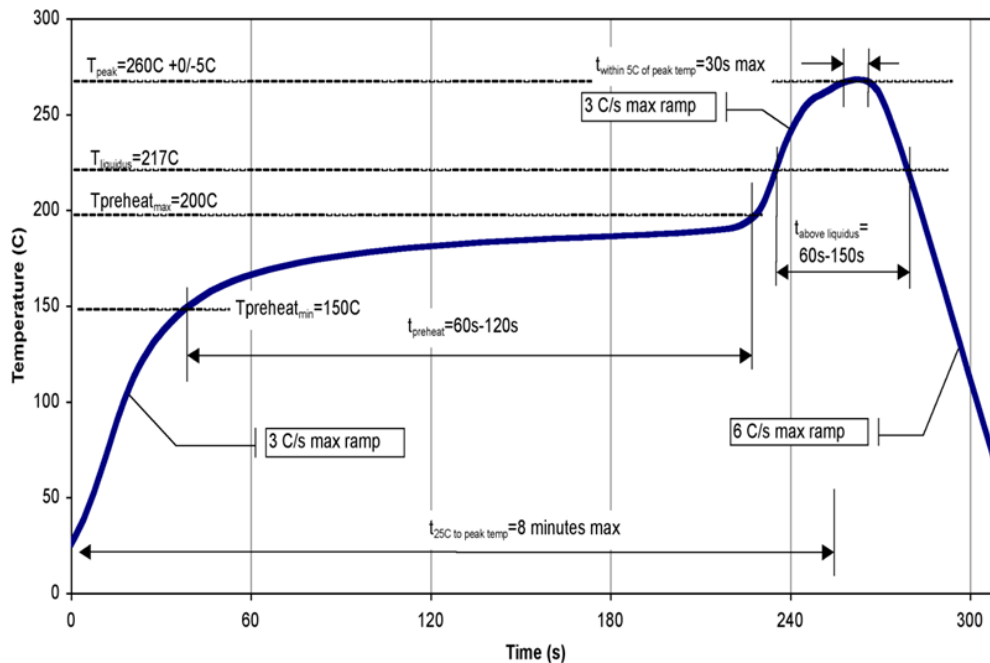

Tape and reel Information

Standard T/R size = 500 pieces on a 7" reel.

Material		Cavity (mm)				Distance Between Centerline (mm)		Carrier Tape (mm)	Cover Carrier (mm)
Vendor	Vendor P/N	Length (A0)	Width (B0)	Depth (K0)	Pitch (P1)	Length direction (P2)	Width Direction (F)	Width (W)	Width (W)
Tek-Pak	QFN0500X0 500F-L500	5.3	5.3	1.65	8.0	2.00	5.50	12.0	9.20

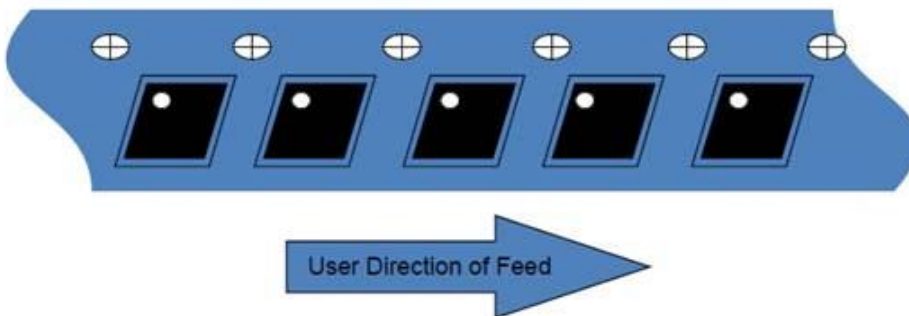
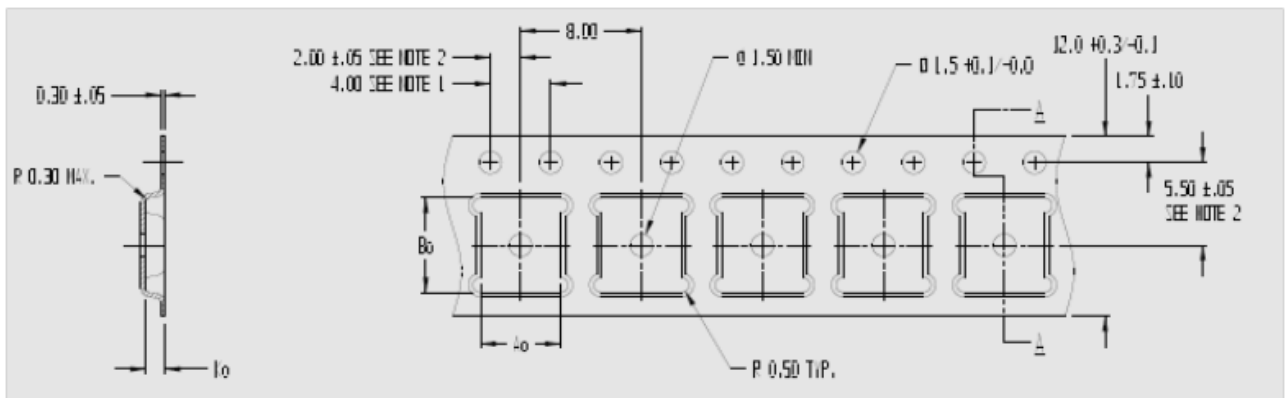

Handling Precautions

Parameter	Rating	Standard
ESD – Human Body Model (HBM)	Class 0B	ESDA / JEDEC JS-001-2012
MSL – Moisture Sensitivity Level	Level 1	IPC/JEDEC J-STD-020



Caution!
ESD-Sensitive Device

RoHS Compliance

This product is compliant with the 2011/65/EU RoHS directive (Restrictions on the Use of Certain Hazardous Substances in Electrical and Electronic Equipment), as amended by Directive 2015/863/EU. This product also has the following attributes:

- Lead Free
- Halogen Free (Chlorine, Bromine)
- Antimony Free
- TBBP-A (C₁₅H₁₂Br₄O₂) Free
- PFOS Free
- SVHC Free

Contact Information

For the latest specifications, additional product information, worldwide sales and distribution locations:

Tel: 1-844-890-8163

Web: www.qorvo.com

Email: customer.support@qorvo.com

Important Notice

The information contained herein is believed to be reliable; however, Qorvo makes no warranties regarding the information contained herein and assumes no responsibility or liability whatsoever for the use of the information contained herein. The information contained herein is subject to change without notice. Customers should obtain and verify the latest relevant information before placing orders for Qorvo products. The information contained herein or any use of such information do not grant, explicitly or implicitly, to any party any patent rights, licenses, or any other intellectual property rights, whether with regard to such information itself or anything described by such information. **THIS INFORMATION DOES NOT CONSTITUTE A WARRANTY WITH RESPECT TO THE PRODUCTS DESCRIBED HEREIN, AND QORVO HEREBY DISCLAIMS ALL WARRANTIES WITH RESPECT TO SUCH PRODUCTS WHETHER EXPRESS OR IMPLIED BY LAW, COURSE OF DEALING, COURSE OF PERFORMANCE, USAGE OF TRADE OR OTHERWISE, INCLUDING THE IMPLIED WARRANTIES OF MERCHANTABILITY AND FITNESS FOR A PARTICULAR PURPOSE.**

Without limiting the generality of the foregoing, Qorvo products are not warranted or authorized for use as critical component in medical, life-saving, or life-sustaining applications, or other applications where a failure would reasonably be expected cause severe personal injury or death.

Copyright 2020 © Qorvo, Inc. | Qorvo is a registered trademark of Qorvo, Inc.