

This section provides designers with the data sheet specifications HardCopy® II devices. These chapters contain feature definitions of the internal architecture, configuration and JTAG boundary-scan testing information, DC operating conditions, AC timing parameters, a reference to power consumption, and ordering information for HardCopy II devices.

This section contains the following:

- “Introduction to HardCopy II Devices” on page 1-1
- “Description, Architecture, and Features” on page 2-1
- “Boundary-Scan Support” on page 3-1
- “DC and Switching Specifications and Operating Conditions” on page 4-1
- “Quartus II Support for HardCopy II Devices” on page 5-1
- “Script-Based Design for HardCopy II Devices” on page 6-1
- “Timing Constraints for HardCopy II Devices” on page 7-1
- “Migrating Stratix II Device Resources to HardCopy II Devices” on page 8-1

Revision History

Refer to each chapter for its own specific revision history. For information on when each chapter was updated, refer to the Chapter Revision Dates section, which appears in the complete handbook.

Introduction

HardCopy® II devices are low-cost, high-performance structured ASICs with pin-outs, densities, and architecture that complement Stratix® II devices. HardCopy II device features, such as phase-locked loops (PLLs), memory, and I/O elements (IOEs), are functionally and electrically equivalent to the Stratix II FPGA features. The combination of Stratix II FPGAs for in-system prototype and design verification, HardCopy II devices for high-volume production, and the Quartus® II software for design, provide a complete, low-risk design solution.

HardCopy II devices improve on the successful and proven methodology of the two previous generations of HardCopy series devices. Altera® HardCopy II devices use the same base arrays across multiple designs for a given device density and are customized using only two metal layers. HardCopy II devices offer up to 90% cost reduction compared to Stratix II FPGA prototypes.

The Quartus II software provides a complete set of tools, common for both designing Stratix II FPGA prototypes and for quickly migrating the design to a HardCopy II companion device. HardCopy II devices are also supported through other front-end design tools from Synopsys, Synplicity, and Mentor Graphics®.

Feature Overview

HardCopy II structured ASICs are manufactured on a 1.2 V, 90 nm all-layer-copper metal fabrication process (up to nine layers of metal). HardCopy II devices offer the following features:

- Fine-grained *HCell* architecture resulting in a low-cost, high-performance, low-power structured ASIC
- Customized using only two metal layers for fast turn-around times and low non-recurring expenses (NRE)
- Fully tested prototypes are available in approximately 10 to 12 weeks from the date of your design submission
- Support for instant-on or instant-on-after-50-ms power-up modes
- Preserves the design functionality of a Stratix II FPGA prototype
- 1,000,000 to 3,600,000 usable gates for both logic and DSP functions

- System performance up to 350 MHz
- Up to 50% power reduction (dynamic and static) for typical designs compared to Stratix II FPGA prototypes



The actual performance and power consumption improvements mentioned in this datasheet are design-dependent.

- Internal Memory
 - Up to 8,847,360 RAM bits available (including parity bits)
 - True dual-port memory, suitable for use in first-in-first-out (FIFO) buffers
- Phase-Locked Loops (PLLs)
 - Up to 16 global clocks with 24 clocking resources per device region
 - Clock control block supports dynamic clock network enable/disable and dynamic global clock network source selection
 - Up to 12 PLLs (four enhanced PLLs and eight fast PLLs) per device which provide identical features as the FPGA counterparts, including spread spectrum, programmable bandwidth, clock switchover, real-time PLL reconfiguration, advanced multiplication, and phase shifting
- I/O Standards and Intellectual Property (IP)
 - Support for numerous single-ended and differential I/O standards such as LVTTTL, LVCMOS, PCI, PCI-X, SSTL, HSTL, and LVDS
 - High-speed differential I/O support on up to 116 channels with dynamic phase alignment (DPA) circuitry for 1-Gigabit-per-second (Gbps) performance
 - Support for high-speed networking and communications bus standards including Parallel RapidIO, SPI-4 Phase 2 (POS-PHY Level 4), HyperTransport™ technology, and SFI-4
 - Support for high-speed external memory, including DDR and DDR2 SDRAM, RLDRAM II, QDR II SRAM, and SDR SDRAM
 - Support for multiple intellectual property megafunctions from Altera MegaCore® functions, and Altera Megafunction Partners Program (AMPPSM) megafunctions
- Packaging
 - Pin-compatible with Stratix II FPGA prototypes
 - Up to 951 user I/O pins available
 - Available in wire bond and flip-chip space-saving FineLine BGA packages (Table 1-3).

The HardCopy II device family consists of five devices. [Table 1-1](#) summarizes the features available in the HardCopy II devices.

Feature	HC210W (1)	HC210	HC220	HC230	HC240
ASIC equivalent gates (2)	1,000,000	1,000,000	1,900,000	2,900,000	3,600,000
M4K RAM blocks (4 Kbits plus parity)	190	190	408	614	768 (3)
M-RAM blocks (512 Kbits plus parity)	0	0	2	6	9
Total RAM bits (including parity bits)	875,520	875,520	3,059,712	6,368,256	8,847,360
Enhanced PLLs	2	2	2	4	4
Fast PLLs	2	2	2	4	8
Maximum user I/O pins (4), (5)	308	334	494	698	951

Notes to Table 1-1:

- (1) HC210W devices are in a wire bond package. All other HardCopy II devices and Stratix II FPGAs use a flip-chip package. Devices in a wire bond package offer different performance and signal integrity characteristics compared to devices in a flip-chip package.
- (2) This is the number of ASIC equivalent gates available in the HardCopy II base array, shared between both adaptive logic module (ALM) logic and DSP functions from a Stratix II FPGA prototype. Each Stratix II adaptive logic module (ALM) is equal to approximately 30 ASIC equivalent gates. The number of ASIC equivalent gates usable is bounded by the number of ALMs in the companion Stratix II FPGA device.
- (3) Total number of usable M4K blocks is 768, which allows migration compatibility when prototyping with an EP2S180 device. This may be different from the Quartus II software total physical M4K count of the HC240.
- (4) The I/O pin counts include the dedicated CLK input pins, which can be used for clock signals or data inputs.
- (5) The Quartus III I/O pin counts include an additional pin (P_{LL}ENA), which is not available as a general-purpose I/O pin. The P_{LL}ENA pin can only be used to enable the PLLs.

Migration and Packaging Overview

HardCopy II devices offer pin-to-pin compatibility to the Stratix II prototype, which makes them drop-in replacements for the FPGAs. Therefore, the same system board and software developed for prototyping and field trials can be retained, enabling the fastest time-to-market for high-volume production. When migrating a specific Stratix II FPGA to a HardCopy II device, there are a number of FPGA prototype choices, as shown in [Table 1–2](#). Depending on the design resource needs, designers can choose an appropriate HardCopy II device.

Table 1–2. Stratix II FPGA to HardCopy II Migration Paths

HardCopy II Device	Package	Stratix II Device				
		EP2S30	EP2S60	EP2S90	EP2S130	EP2S180
HC210W	484-pin FineLine BGA (1)	✓	✓	✓ (2)		
HC210	484-pin FineLine BGA	✓	✓	✓ (2)		
HC220	672-pin FineLine BGA		✓			
HC220	780-pin FineLine BGA			✓	✓ (2)	
HC230	1,020-pin FineLine BGA			✓	✓	✓ (2)
HC240	1,020-pin FineLine BGA					✓
HC240	1,508-pin FineLine BGA					✓

Notes to Table 1–2:

- (1) The HC210W device uses a wire bond package while the Stratix II FPGA prototype device uses a pin-compatible flip-chip package.
- (2) Depending on design specific resource utilization, an opportunistic migration path may exist between this device pair. Be sure to confirm your design is a potential candidate for such a path by fitting with the Quartus II software and consulting an Altera applications engineer.

HardCopy II devices are available in the packages shown in [Table 1–3](#).

Package	484-Pin FineLine BGA (3)	484-Pin FineLine BGA (3)	672-Pin FineLine BGA	780-Pin FineLine BGA	1,020-Pin FineLine BGA	1,508-Pin FineLine BGA
Type	Wire bond	Flip-chip	Flip-chip	Flip-chip	Flip-chip	Flip-chip
Dimension						
Pitch (mm)	1.00	1.00	1.00	1.00	1.00	1.00
Area (mm ²)	529	529	729	841	1,089	1,600
Length × width (mm × mm)	23 × 23	23 × 23	27 × 27	29 × 29	33 × 33	40 × 40
Device	Maximum User I/O Pins					
HC210W	308					
HC210		334				
HC220			492	494		
HC230					698	
HC240					742	951

Notes to Table 1–3:

- (1) The Quartus III I/O pin counts include an additional pin (P_{LENA}) which is not available as a general-purpose I/O pin. The P_{LENA} pin can only be used to enable the PLLs.
- (2) The I/O pin counts include the dedicated CLK input pins, which can be used for clock signals or data inputs.
- (3) The EP2S90 FPGA prototype uses a 484-pin hybrid FineLine BGA package. For more information, refer to the *Stratix II Device Handbook*.

Document Revision History

[Table 1–4](#) shows the revision history for this chapter.

Date and Document Version	Changes Made	Summary of Changes
September 2008, v2.6	Updated chapter number and metadata.	—
June 2007, v2.5	Minor text edits.	—

Table 1–4. Document Revision History (Part 2 of 2)

Date and Document Version	Changes Made	Summary of Changes
December 2006 v2.4	<ul style="list-style-type: none"> ● Minor updates for the Quartus II software version 6.1.0 ● Merged Table 1-3 and Table 1-4 ● Added revision history 	A minor update to the chapter, due to changes in the Quartus II software version 6.1 release. Merged Table 1-3 and Table 1-4.
March 2006, v2.3	<ul style="list-style-type: none"> ● Updated Table 1-1 and Table 1-3. ● Minor edits and clarifications throughout. 	
October 2005, v2.2.	Updated graphics	
July 2005, v2.2.	Updated graphics	
May 2005, v2.0	<ul style="list-style-type: none"> ● Updated Table 1–1. ● Updated migration process time. ● Updated “Features” section. 	
January 2005 v1.0	Added document to the HardCopy Series Handbook.	



2. Description, Architecture, and Features

H51016-2.5

Introduction

Altera® HardCopy® II devices feature an architecture that provides high-density, high-performance, and low-power consumption suitable for a variety of applications. HardCopy II devices are low-cost structured ASICs with pin-outs, densities, and architecture that complement Stratix® II FPGAs. HardCopy II devices make optimal use of die area and core resources while offering features that are functionally equivalent to the Stratix II FPGA. The combination of Stratix II FPGAs for in-system prototype and design verification, HardCopy II devices for high-volume production, and the Quartus® II design software, provide a complete, seamless path from prototype to volume production. [Table 2-1](#) provides an overview of the HardCopy II device features.

Table 2-1. HardCopy II Family Overview (Part 1 of 2)

Feature	HC210W (1)	HC210	HC220	HC230	HC240
ASIC gates (2)	1,000,000	1,000,000	1,900,000	2,900,000	3,600,000
M4K RAM blocks (4k bits plus parity)	190	190	408	614	768 (3)
M-RAM blocks (512k bits plus parity)	0	0	2	6	9
Total RAM bits (including parity bits)	875,520	875,520	3,059,712	6,368,256	8,847,360
Enhanced PLLs	2	2	2	4	4
Fast PLLs	2	2	2	4	8
Package (maximum user I/O pins) (4), (5)	484-pin FineLine BGA (308)	484-pin FineLine BGA (334)	672-pin FineLine BGA (492) 780-pin FineLine BGA (494)	1,020-pin FineLine BGA (698)	1,020-pin FineLine BGA (742) 1,508-pin FineLine BGA (951)

Table 2–1. HardCopy II Family Overview (Part 2 of 2)

Feature	HC210W (1)	HC210	HC220	HC230	HC240
FPGA prototype options	EP2S30 EP2S60 EP2S90	EP2S30 EP2S60 EP2S90	EP2S60 EP2S90 EP2S130	EP2S90 EP2S130 EP2S180	EP2S180

Notes to Table 2–1:

- (1) HC210W devices use a wire bond package. All other HardCopy II devices and Stratix II FPGAs use a flip-chip package. Devices in a wire bond package offer different performance and signal integrity characteristics compared to devices in a flip-chip package.
- (2) This is the number of ASIC gates available in the HardCopy II base array for both logic and DSP functions that can be implemented in a Stratix II FPGA prototype.
- (3) Total number of usable M4K blocks is 768, which allows migration compatibility when prototyping with an EP2S180 device. This may be different from the Quartus II software total physical M4K count of the HC240.
- (4) The I/O pin counts include the dedicated clock input pins, which can be used for clock signals or data inputs.
- (5) The Quartus II I/O pin counts include an additional pin (P_{LL}ENA), which is not available as a general-purpose I/O pin. The P_{LL}ENA pin can only be used to enable the PLLs.

Functional Description

The HardCopy II device family provides greater flexibility to design with FPGA prototypes before moving to structured ASICs for production. Before seamlessly migrating to the HardCopy II structured ASIC, designers can prototype and test their design functionality using a Stratix II FPGA. There are multiple options for the prototype FPGA, allowing designers to choose the right HardCopy II device for volume production and maximum cost savings. The Quartus II design software includes features such as the Device Resource Guide, to help select the optimal HardCopy II device based on the design requirements.



For more information on the Device Resource Guide, refer to the *Quartus II Support for HardCopy II Devices* chapter in the *HardCopy Series Handbook*.

HardCopy II devices require minimal involvement from the designer in the device migration process. Additionally, unlike ASICs, the designer is not required to generate test benches, test vectors, or timing and functional simulations since prototyping is performed using an FPGA.

HardCopy II devices consist of base arrays that are common to all designs for a particular device density, with design-specific customization done using two metal layers. The reprogrammable FPGA logic, routing, memory, and FPGA configuration-related logic are stripped from HardCopy II devices. Removing all programmable and configuration resources and replacing them with direct metal connections results in considerable die size reduction and cost savings. A fine-grain architecture consisting of an array of HCells extends the die reduction and cost

savings, which results in low-cost structured ASICs with high-performance and low-power suitable for a wide variety of applications.

The SRAM configuration cells of the Stratix II FPGAs are replaced in HardCopy II devices with metal connections, which define the function of logic, memory, phase-locked loop (PLL), and I/O elements (IOEs) in the device. These resources are interconnected using metallization layers. Once a HardCopy II device is manufactured, the functionality of the device is fixed.

HardCopy II devices are manufactured using the same 90-nm process technology and operate using the same core voltage (1.2 V) as Stratix II FPGAs. Additionally, almost all architectural features in HardCopy II devices are functionally equivalent to features found in the Stratix II FPGA architecture. HardCopy II devices feature HCells, memory blocks, PLLs, and IOEs (Figure 2–1).

Figure 2–1. Example Block Diagram of HC230 Device *Note (1)*

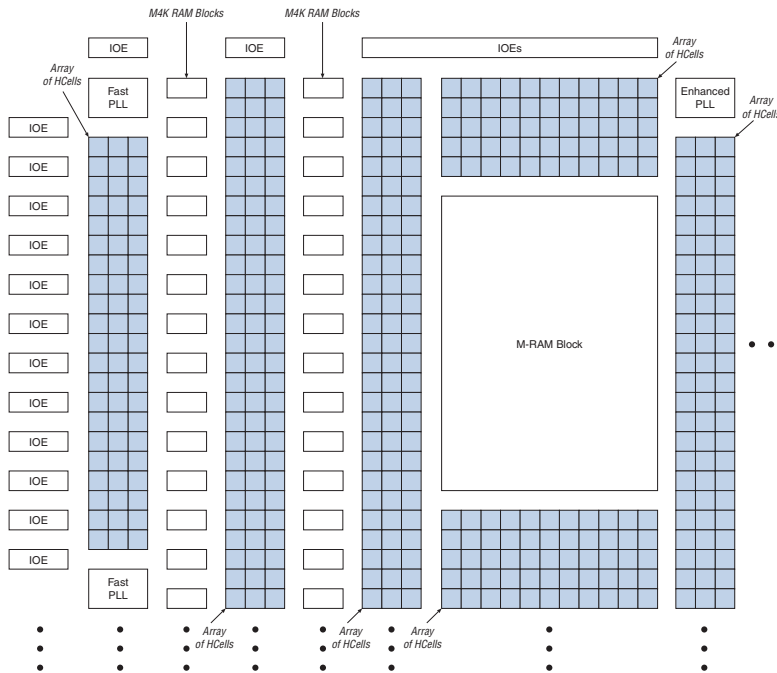

Note to Figure 2–1:

- (1) Figure 2–1 shows a graphical representation of the device floor plan. A detailed floor plan is available in the Quartus II software.

HardCopy II and Stratix II Similarities and Differences

HardCopy II devices preserve the functionality of Stratix II FPGAs. Implementation of these architectural features in HardCopy II structured ASICs matches Stratix II FPGA implementation, with a few exceptions. Table 2–2 shows a qualitative comparison of HardCopy II device feature implementation versus Stratix II FPGA feature implementation. Other sections within this chapter provide details on similarities and differences of a particular HardCopy II feature.

Feature	Equivalent	Different
Logic blocks		✓
DSP blocks		✓
Memory	✓	
Clock networks	✓	
PLLs	✓	
I/O features	✓	
Configuration (1)		✓

Note to Table 2–2:

(1) HardCopy II structured ASICs do not need to be configured upon power-up.

The major similarities and differences between Stratix II FPGAs and HardCopy II devices are highlighted below:

- HardCopy II may result in a power reduction of up to 50% than an equivalent Stratix II FPGAs operating at the same frequency. Power consumption is design dependent and is a direct result of design performance and resource utilization.
- HardCopy II devices offer up to 100% performance improvement when compared to Stratix II FPGA prototypes. The performance improvement is achieved by efficient use of logic blocks, metal interconnect optimization, die size reduction, and customized signal buffering.
- Logic blocks, known as HCells, are the basic building block of the core logic in HardCopy II devices and replace Stratix II adaptive logic modules (ALMs). HCells implement logic and DSP functions.
- DSP block functions are implemented using HCells, instead of dedicated DSP blocks.
- M4K and M-RAM memory blocks can implement various types of memory (the same as Stratix II FPGAs), with or without parity, including true dual-port, simple dual-port, and single-port RAM, ROM, and first-in first-out (FIFO) buffers.

- Unlike Stratix II FPGAs, the HardCopy II M4K block contents cannot be pre-loaded with a Memory Initialization File (.mif) when used as RAM. When used as ROM, HardCopy II M4K blocks are initialized to the ROM contents.
- When used as RAM, and you select the non-registered output mode, HardCopy II M4K and M-RAM blocks power up with outputs unknown. In Stratix II FPGAs, M4K blocks power up with outputs cleared, while M-RAM blocks power up with outputs unknown. If registered outputs mode is selected, the outputs are cleared on both the M4K and M-RAM blocks in HardCopy II.
- The memory contents are unknown under both instances.
- All HardCopy II clock network features are the same as in Stratix II FPGAs.
- Enhanced PLL and fast PLL implementations in HardCopy II devices are the same as in Stratix II FPGAs.
- All Stratix II I/O features and supported I/O standards are offered in HardCopy II devices.
- The Joint Test Action Group (JTAG) boundary scan order and length in HardCopy II devices is different than that of the Stratix II FPGA. Use a HardCopy II boundary-scan description language (BSDL) file that describes the re-ordered and shortened boundary scan chain.
- Unlike Stratix II devices, HardCopy II devices are customized using two metal layers. Therefore, configuration circuitry is not required. FPGA configuration emulation and other configuration modes, including remote system upgrades and design security using configuration bitstream encryption, are not supported in HardCopy II devices.
- Even though configuration is not required, the `CRC_ERROR` pin function is supported by the HardCopy II using Quartus II software version 6.0 and above. There is no need to recompile the Stratix II design to eliminate this feature.



Only supplementary information to highlight HardCopy II similarities and differences compared to the Stratix II FPGA architecture and functionality is provided in this chapter. For more information on similarities and differences of available resources of the HardCopy II, refer to the *Migrating Stratix II Device Resources to HardCopy II Devices* chapter of this Handbook. In addition, the *Stratix II Device Handbook* has detailed explanations of architectural features and functions that are similar to the HardCopy II devices.

HCells

HardCopy II devices are built using an array of fine-grained architecture blocks called HCells. HCells are a collection of logic transistors based on 1.2 V, 90 nm process technology, similar to Stratix II devices. The construction of logic using HCells allows flexible functionality such that when HCells are combined, all viable logic combinations of Stratix II functionality are replicated. These HCells constitute the array of HCells area in [Figure 2-1](#). Only HCells needed to implement the customer design are assembled together, which optimizes HCell utilization. The unused area of the HCell logic fabric is powered down, resulting in significant power savings compared with the Stratix II FPGA prototype.

The Quartus II software uses the library of pre-characterized HCell macros to place Stratix II ALM and DSP configurations into the HardCopy II HCell-based logic fabric. An HCell macro defines how a group of HCells are connected together within the array. HCell macros can construct all combinations of combinational logic, adder, and register functions that can be implemented by a Stratix II ALM. HCells not used for ALM configurations can be used to implement DSP block functions.

Based on design requirements, the Quartus II software will chose the appropriate HCell macros to implement the design functionality. For example, Stratix II ALMs offer flexible look-up table (LUT) blocks, registers, arithmetic blocks, and LAB-wide control signals. In HardCopy II devices, if your design requires these architectural elements, the Quartus II synthesis tool will map the design to the appropriate HCells, resulting in improved design performance compared to the Stratix II FPGA prototype.

Stratix II FPGAs have dedicated DSP blocks to implement various DSP functions. Stratix II DSP blocks consist of a multiplier block, an adder/subtractor/accumulator block, a summation block, input and output interfaces, and input and output registers. In HardCopy II devices, HCell macros implement Stratix II DSP block functionality with area efficiency and performance on par with the dedicated DSP blocks in Stratix II FPGAs.

There are eight HCell macros which implement the eight supported modes of operation for the Stratix II DSP block:

- 9 × 9 multiplier
- 9 × 9 two-multiplier adder (9 × 9 complex multiply)
- 9 × 9 four-multiplier adder
- 18 × 18 multiplier
- 18 × 18 two-multiplier adder (18 × 18 complex multiply)
- 18 × 18 four-multiplier adder
- 52-bit (18 × 18) multiplier-accumulator
- 36 × 36 multiplier

Only HCells that are required to implement the design's DSP functions are enabled. HCells not needed for DSP functions can be used for ALM configurations, which results in efficient logic usage. In addition to area management, the placement of these HCell macros allows for optimized routing and performance.

An example of efficient logic area usage can be seen when comparing the 18×18 multiplier implementation in Stratix II FPGAs using the dedicated DSP block versus the implementation in HardCopy II devices using HCells. If the Stratix II DSP function only calls for one 18×18 multiplier, the other three 18×18 multipliers and the DSP block's adder output block are not used (Figure 2-2). In HardCopy II devices, the HCell-based logic fabric that is not used for DSP functions can be used to implement other combinational logic, adder, and register functions.

Figure 2-2. Stratix II DSP Block versus HardCopy II HCell 18×18 -Bit Multiplier Implementation

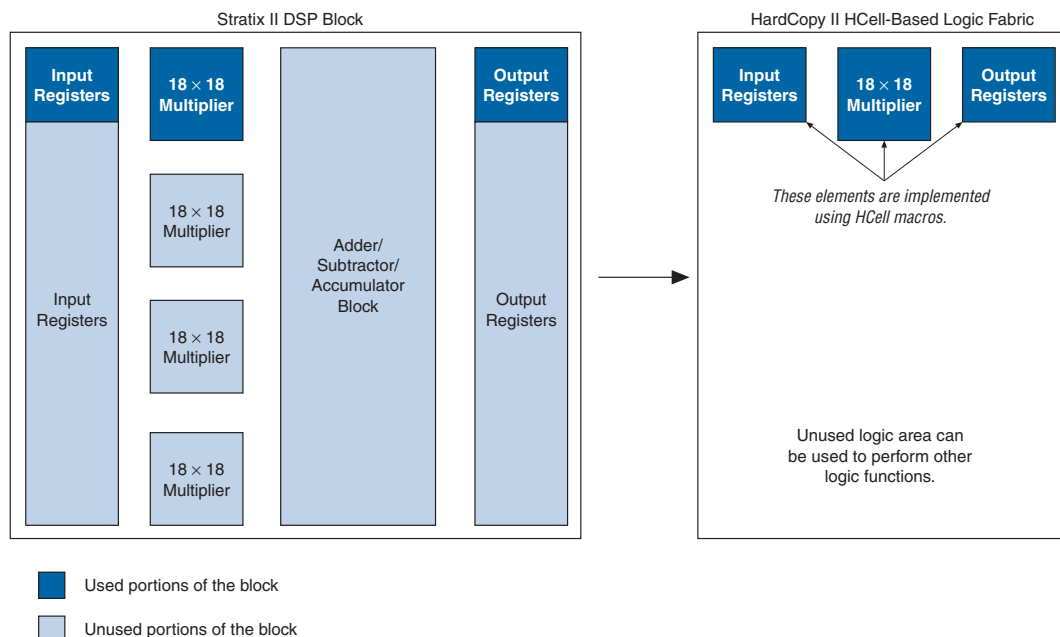

HardCopy II devices support all Stratix II DSP configurations (9×9 , 18×18 , and 36×36 multipliers) and all Stratix II DSP block features, such as dynamic sign controls, dynamic addition/subtraction, saturation, rounding, and dynamic input shift registers, except for dynamic mode switching.

Dynamic mode switching allows the designer to set up each Stratix II DSP block to dynamically switch between the following three modes:

- Up to four 18-bit independent multipliers
- Up to two 8-bit multiplier-accumulators
- One 36-bit multiplier

Each half of a Stratix II DSP block has separate mode control signals. Since DSP block functions are implemented in HardCopy II devices using HCells, HardCopy II devices do not support dynamic mode switching. If this feature is used, the Quartus II software flags the DSP implementation and does not allow you to migrate the design. The fitter reports that all HardCopy II devices are not compatible with the design. To migrate your Stratix II design to a HardCopy II companion device, disable dynamic switching in the DSP blocks.



For more information on the Stratix II DSP operational modes, refer to the *Stratix II Device Handbook*.

Embedded Memory

HardCopy II memory blocks can implement various types of memory with or without parity, including true dual-port, simple dual-port, and single-port RAM, ROM, and FIFO buffers. HardCopy II devices support the same memory functions and features as Stratix II FPGAs.

Functionally, the memory in both devices are identical. However, the number of available memory blocks differs based on density ([Table 2-3](#)).

Table 2-3. HardCopy II Embedded Memory Resources

Feature	HC210W	HC210	HC220	HC230	HC240
M4K RAM blocks (4 Kbits)	190	190	408	614	768
M-RAM blocks (512 Kbits)	0	0	2	6	9
Total RAM bits (bits)	875,520	875,520	3,059,712	6,368,256	8,847,360

Since device functionality is fixed in HardCopy II devices, M4K block contents cannot be preloaded or initialized with a MIF when they are configured as RAM. When the M4K blocks are used as ROM, they will initialize to the design's ROM contents.

When using the non-registered outputs mode for the HardCopy II M4K memory block, the outputs power up uninitialized. When using the registered outputs mode for the HardCopy II M4K memory blocks, the

outputs are cleared on power up. The designer needs to take these into consideration when designing logic that might evaluate the initial power-up values of the memory block.

HardCopy II embedded memory consists of M4K and M-RAM memory blocks and have a one-to-one mapping from Stratix II M4K and M-RAM resources. [Table 2-4](#) shows the size and features of the different RAM blocks.



For more information on the Stratix II memory block features, refer to the *Stratix II Device Handbook*.

PLLs and Clock Networks

Both HardCopy II enhanced and fast PLLs are feature rich, supporting advanced capabilities such as clock switchover, reconfigurable phase shift, PLL reconfiguration, and reconfigurable bandwidth. PLLs are used for general-purpose clock management, supporting multiplication, division, phase shifting, and programmable duty cycle. In addition, enhanced PLLs support external clock feedback mode, spread-spectrum clocking, and counter cascading. Fast PLLs offer high speed outputs to manage the high-speed differential I/O interfaces.



All Stratix II PLL features are supported by HardCopy II PLLs.

Similar to Stratix II FPGAs, HardCopy II devices also support a power-down mode where unused clock networks can be disabled. HardCopy II and Stratix II clock control blocks support dynamic selection of the input clock from up to four possible sources, giving the designer the flexibility to choose from multiple (up to four) clock sources.

Feature	M4K Blocks	M-RAM Blocks
Maximum performance (1), (4)	350 MHz	350 MHz
Total RAM bits (including parity bits)	4,608	589,824
Configurations	4K × 1 2K × 2 1K × 4 512 × 8 512 × 9 256 × 16 256 × 18 128 × 32 128 × 36	64K × 8 64K × 9 32K × 16 32K × 18 16K × 32 16K × 36 8K × 64 8K × 72 4K × 128 4K × 144
Parity bits	✓	✓
Byte enable	✓	✓
Pack mode	✓	✓
Address clock enable	✓	✓
Single-port memory	✓	✓
Simple dual-port memory	✓	✓
True dual-port memory	✓	✓
Embedded shift register	✓	
ROM	✓	
FIFO buffer	✓	✓
Simple dual-port mixed width support	✓	✓
True dual-port mixed width support	✓	✓
Memory initialization file (.mif)	Not supported, except in ROM mode	Not supported
Mixed-clock mode	✓	✓
Power-up condition (2)	Outputs unknown	Outputs unknown
Register clears (3)	Output registers only	Output registers only
Same-port read-during-write	New data available at positive clock edge	New data available at positive clock edge
Mixed-port read-during-write	Outputs set to unknown or old data	Unknown output

Table 2-4. HardCopy II Embedded Memory Features (Part 2 of 2) Notes (1), (2), (3)		
Feature	M4K Blocks	M-RAM Blocks

Note to Table 2-4:

- (1) Maximum performance information is preliminary until device characterization.
- (2) The memory cells power up randomly, so reads before writes are not valid. Make sure you write to the memory location before you read it.
- (3) Even though the output register is cleared, the memory cells power up randomly. So reads before write are not valid. Make sure you write to the memory location first before reading it.
- (4) Violating the setup or hold time requirements on the address registers could corrupt the memory contents. This applies to both read and write operations.

Enhanced and Fast PLLs

The number of PLLs available differs based on density (Table 2-5).

Table 2-5. HardCopy II PLLs					
Feature	HC210W	HC210	HC220	HC230	HC240
Enhanced PLLs	2	2	2	4	4
Fast PLLs	2	2	2	4	8

The target HardCopy II device may not support the same number of enhanced PLLs as the prototyping Stratix II FPGA. However, since HardCopy II enhanced PLLs and fast PLLs offer a similar feature set (Table 2-7 on page 2-13), a fast PLL could be used in place of an enhanced PLL. The type of PLL used in the design should be chosen using the Quartus II software to accommodate the resources available in the HardCopy II device.

Table 2-6 shows which PLLs are available in each device density. Figure 2-3 shows the location of each PLL. During the prototyping stage using the FPGA, you must select the appropriate number of enhanced and fast PLLs that will be used in your HardCopy II device. Use Table 2-6 to ensure that the FPGA prototyping design uses the same PLL resources available in the HardCopy II device.

Table 2-6. HardCopy II PLLs Available (Part 1 of 2) Note (1)												
Device	Fast PLLs								Enhanced PLLs			
	1	2	3	4	7	8	9	10	5	6	11	12
HC210W	✓	✓							✓	✓		
HC210	✓	✓							✓	✓		

Table 2-6. HardCopy II PLLs Available (Part 2 of 2) Note (1)

Device	Fast PLLs								Enhanced PLLs			
	1	2	3	4	7	8	9	10	5	6	11	12
HC220	✓	✓							✓	✓		
HC230	✓	✓			✓	✓			✓	✓	✓	✓
HC240	✓	✓	✓	✓	✓	✓	✓	✓	✓	✓	✓	✓

Note to Table 2-6:

- (1) PLL performance in the HC210W device may differ from the Stratix II FPGA prototype.

Figure 2-3. HardCopy II PLL Locations Notes (1), (2)

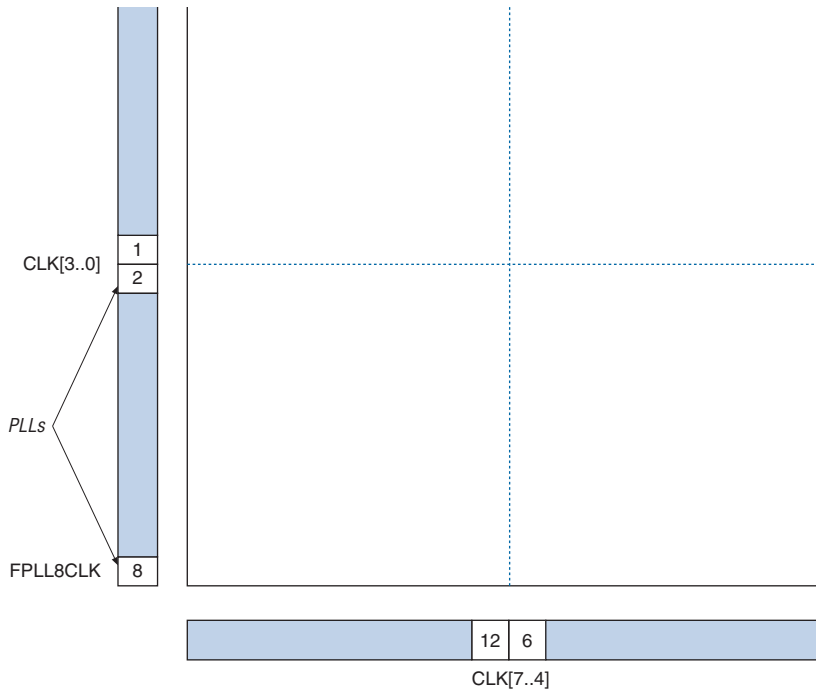

Notes to Figure 2-3:

- (1) The PLLs may be located in the periphery or in the core of the device.
- (2) This is the die-level top view of the device and is only a graphical representation of the PLL locations.

PLL functionality in HardCopy II devices remains the same as in Stratix II FPGA PLLs. Therefore, the HardCopy II PLLs support PLL reconfiguration (the PLL can be dynamically configured in user mode).

HardCopy II enhanced and fast PLLs support a one-to-one mapping from Stratix II PLL resources. Table 2-7 shows the features of the different PLLs. For more information on the Stratix II PLL features, refer to the *Stratix II Device Handbook*.

Feature	Enhanced PLL	Fast PLL
Clock multiplication and division	$m/(n \times \text{post-scale counter})$ (1)	$m/(n \times \text{post-scale counter})$ (2)
Phase shift	Down to 125-ps increments (3)	Down to 125-ps increments (3)
Clock switchover	✓	✓ (4)
PLL reconfiguration	✓	✓
Reconfigurable bandwidth	✓	✓
Spread-spectrum clocking	✓	
Programmable duty cycle	✓	✓
Number of clock outputs per PLL (5)	6	4
Number of dedicated external clock outputs per PLL	Three differential or six singled-ended	(6)
Number of feedback clock inputs per PLL	1 (7)	

Notes to Table 2-7:

- (1) For enhanced PLLs, m and n range from 1 to 512 and post-scale counters range from 1 to 512 with 50% duty cycle. For non-50% duty-cycle clock outputs, post-scale counters range from 1 to 256.
- (2) For fast PLLs, n can range from 1 to 4. The post-scale and m counters range from 1 to 32. For non-50% duty-cycle clock outputs, post-scale counters range from 1 to 16.
- (3) The smallest phase shift is determined by the voltage controlled oscillator (VCO) period divided by eight. The supported phase shift range is from 125 to 250 ps. HardCopy II devices can shift all output frequencies in increments of at least 45°. Smaller degree increments are possible depending on the frequency and divide parameters. For non-50% duty cycle clock outputs post-scale counters range from 1 to 256.
- (4) HardCopy II fast PLLs only support manual clock switchover.
- (5) The clock outputs can be driven to internal clock networks or to a pin.
- (6) The PLL clock outputs of the fast PLLs can drive to any I/O pin to be used as an external clock output. For high-speed differential I/O pins, the device uses a data channel to generate the transmitter output clock (txclkout).
- (7) If the design uses external feedback input pins, you will lose one (or two, if f_{BIN} is differential) dedicated external clock output pin.

Clock Networks

There are 16 clock pins (CLK[15..0]) in HardCopy II devices that can drive either the global- or regional-clock networks. The CLK pins can drive clock ports or data inputs.

HardCopy II devices provide 16 dedicated global-clock networks and 32 regional-clock networks; the same as in Stratix II FPGAs. These clocks are organized to provide 24 unique clock sources per device quadrant with low skew and delay. This clocking scheme provides up to 48 unique clock domains within the entire HardCopy II device. Table 2-8 lists the clock resources and features available in HardCopy II devices.

Table 2-8. Clock Network Resources and Features Available in HardCopy II Devices

Resources and Features	Availability
Number of global clock networks	16
Number of regional clock networks	32
Global clock input sources	Clock input pins, PLL outputs, logic array
Regional clock input sources	Clock input pins, PLL outputs, logic array
Number of unique clock sources in a quadrant	24 (16 global clocks and 8 regional clocks)
Number of unique clock sources in the entire device	48 (16 global clocks and 32 regional clocks)
Power-down mode	Global- and regional-clock networks, dual-regional-clock region
Clocking regions for high fan-out applications	Quadrant region, dual-regional, entire device via global- or regional-clock networks

HardCopy II devices also support the same features as the Stratix II clock control block, which is available for each global- and regional-clock network. The control block has two functions:

- Clock source selection (dynamic selection for global clocks):
You user can either dynamically select between two PLL outputs, between two clock pins (CLK_p or CLK_n), or a combination of the clock pins or PLL outputs.
- Clock power-down (dynamic clock enable or disable):
In HardCopy II devices, you can dynamically turn the clock off or on in user-mode.

I/O Structure and Features

The structure and features of the HardCopy II IOE remains the same as in Stratix II. Any feature implemented in Stratix II IOEs can be migrated to Hardcopy II IOEs.

The IOE feature set in HardCopy II devices can be classified in one of three categories:

- General purpose IOEs—The most commonly used I/O type in designs.
- Memory Interface IOEs—Includes features to interface with common external memory standards.
- High-speed IOEs—Supports high-speed data transmission and reception.

All I/O pins in Stratix II FPGAs support general-purpose I/O standards, which includes the LVTTTL and LVCMOS I/O standards. In Stratix II FPGAs, the PCI clamping diode and memory interfaces are supported on the top and bottom I/O pins, while high-speed interfaces are supported on the left and right side I/O pins of the device.

The new general purpose IOEs in HardCopy II devices are a cost saving and area efficient advantage. The complex memory interface and the high-speed IOE circuitry is removed to save die area while still offering the more commonly-used features. The memory interface IOE supports all the features available in the general purpose IOE. The high-speed IOE also supports all the same features and I/O standards as the general purpose IOE, except for the PCI clamping diode (supported on the bottom general purpose IOEs in HC210 and HC220 devices).

In order to increase the I/O area efficiency of HardCopy II devices, the features available on any given IOE depends on the location.

Table 2-9 shows which I/O standards are supported by the different IOE types.

I/O Standard	Type	V _{CCIO} Level (V)		Memory Interface IOEs	General Purpose IOEs	High-Speed IOEs
		Input	Output			
3.3-V LVTTTL/ LVCMOS	Single-ended	3.3/2.5	3.3	✓	✓	✓
2.5-V LVTTTL/ LVCMOS	Single-ended	3.3/2.5	2.5	✓	✓	✓
1.8-V LVTTTL/ LVCMOS	Single-ended	1.8/1.5	1.8	✓	✓	✓
1.5-V LVCMOS	Single-ended	1.8/1.5	1.5	✓	✓	✓
SSTL-2 class I	Voltage referenced	2.5	2.5	✓		

Table 2–9. HardCopy II Supported I/O Standards (Part 2 of 3)

I/O Standard	Type	V _{CCIO} Level (V)		Memory Interface IOEs	General Purpose IOEs	High-Speed IOEs
		Input	Output			
SSTL-2 class II	Voltage referenced	2.5	2.5	✓		
SSTL-18 class I	Voltage referenced	1.8	1.8	✓		
SSTL-18 class II	Voltage referenced	1.8	1.8	✓		
1.8-V HSTL class I	Voltage referenced	1.8	1.8	✓		
1.8-V HSTL class II	Voltage referenced	1.8	1.8	✓		
1.5-V HSTL Class I	Voltage referenced	1.5	1.5	✓		
1.5-V HSTL Class II	Voltage referenced	1.5	1.5	✓		
PCI/PCI-X	Single-ended	3.3	3.3	✓ (2)	✓ (2)	
Differential SSTL-2 class I and II input	Pseudo differential (1)	3.3/2.5/1.8/1.5		(3)		
Differential SSTL-2 class I and II output	Pseudo differential (1)		2.5	(3)		
Differential SSTL-18 class I and II input	Pseudo differential (1)	3.3/2.5/1.8/1.5		(3)		
Differential SSTL-18 class I and II output	Pseudo differential (1)		1.8	(3)		
1.8-V differential HSTL class I and II input	Pseudo differential (1)	3.3/2.5/1.8/1.5		(3)		
1.8-V differential HSTL class I and II output	Pseudo Differential (1)		1.8	(3)		
1.5-V differential HSTL class I and II input	Pseudo differential (1)	3.3/2.5/1.8/1.5		(3)		
1.5-V differential HSTL class I and II output	Pseudo Differential (1)		1.5	(3)		
LVDS	Differential	2.5	2.5	(5)	(4), (6)	✓
HyperTransport™ technology	Differential	2.5	2.5	(5)	(4), (6)	✓

Table 2–9. HardCopy II Supported I/O Standards (Part 3 of 3)

I/O Standard	Type	V _{CCIO} Level (V)		Memory Interface IOEs	General Purpose IOEs	High-Speed IOEs
		Input	Output			
LVPECL	Differential	3.3/2.5/ 1.8/1.5	(8)	(8)	(8)	

Notes to Table 2–9:

- (1) Pseudo-differential HSTL and SSTL inputs only use the positive-polarity input in the speed path. The negative input is not connected internally. Pseudo-differential HSTL and SSTL outputs use two single-ended outputs with the second output programmed as inverted. This is similar to a Stratix II device implementation.
- (2) The PCI clamping diode is only supported on the I/O pins on the top and bottom sides of the device.
- (3) This I/O standard is only supported on the DQS, CLK and PLL_FB input pins or on the PLL_OUT output pins.
- (4) This I/O standard is only supported on the bottom CLK and PLL_FB input pins or on the bottom PLL_OUT output pins.
- (5) This I/O standard is only supported on the CLK and PLL_FB input pins or on the PLL_OUT output pins.
- (6) Also supported on CLK9 and CLK11 pins.
- (7) This I/O standard is only supported on CLK and PLL_FB input pins.
- (8) LVPECL input I/O standard is supported on the top and bottom CLK and PLL_FB input pins. LVPECL output I/O standard is supported on the top and bottom PLL_OUT output pins. LVPECL support is similar to Stratix II devices.

The three types of IOEs are located in different areas of the device and are described in the following sections. HardCopy II devices have eight I/O banks, just as in Stratix II FPGAs. Figures 2–4 through 2–6 show which I/O type each bank supports.

Figure 2-4. I/O Type Support in HC210 and HC220 Devices Notes (1), (2)

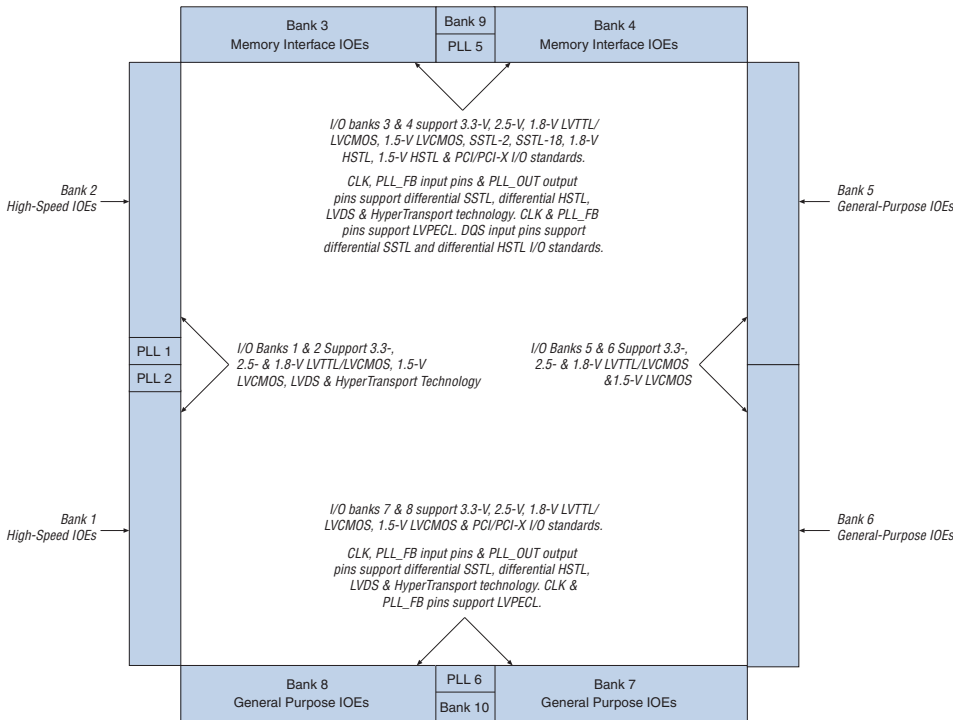

Figure 2–5. I/O Type Support in HC230 Devices Notes (1), (2)

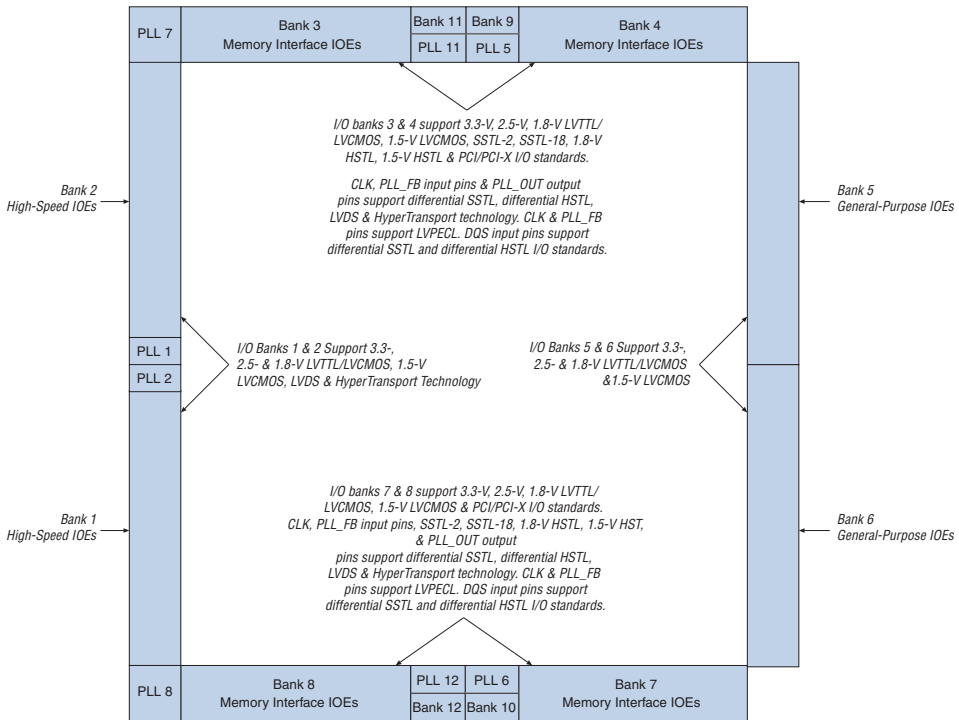
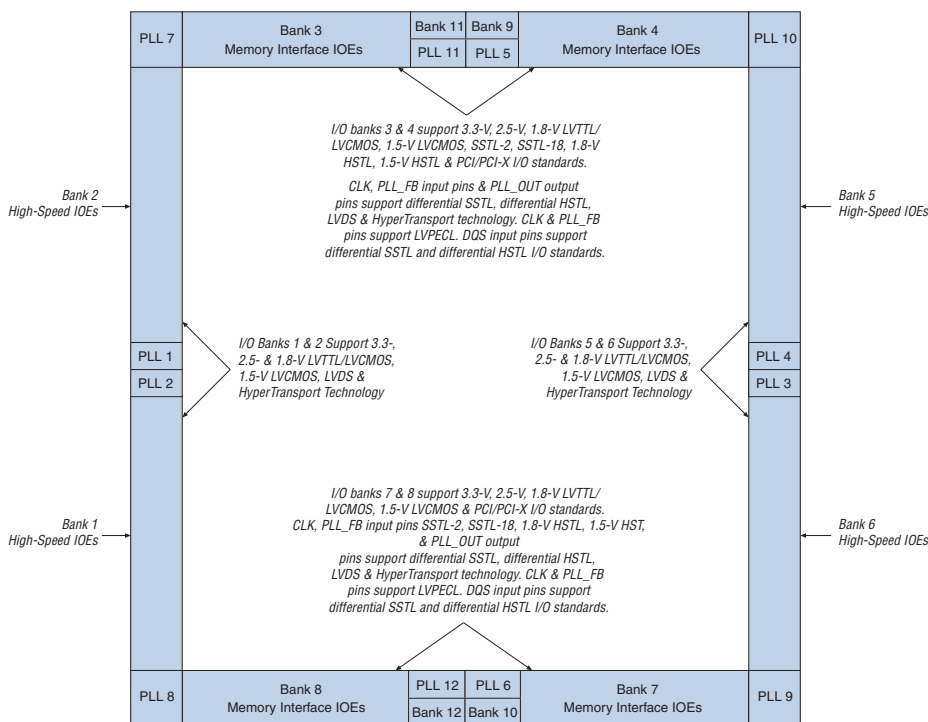

Figure 2–6. I/O Type Support in HC240 Devices Notes (1), (2)



Notes to Figures 2–4 through 2–6:

- (1) In addition to supporting external memory interfaces, memory interface IOEs have the same features as general purpose IOEs. In addition to supporting high-speed I/O interfaces, high-speed IOEs have the same features as general purpose IOEs, except for the PCI clamping diode and LVPECL clock input support.
- (2) This is a top view of the silicon die which corresponds to a reverse view for flip-chip packages. It is a graphical representation only.



When planning I/O placement for designs targeting HardCopy II devices, care should be taken to ensure the same I/O standards are supported in the same HardCopy II I/O banks as in the Stratix II I/O banks.

General Purpose IOE

The general purpose IOEs in HC210 and HC220 devices are located on the right side and at the bottom of the device. The general purpose IOEs in HC230 devices are located on the right side of the device. (Directions are based on a top view of the silicon die.) HC240 devices do not have general purpose IOEs. The general purpose IOE functionality is supported in the memory interface IOEs for these devices. The high-speed IOEs also

provide the same features as the general purpose IOEs except for the PCI clamping diode. In Stratix II FPGAs, all IOEs support the general purpose IOE features except the PCI diode, which is only supported on the top and bottom I/O pins.

The general purpose IOE has many features, including:

- Dedicated single-ended I/O buffers
- 3.3-V, 64-bit, 66 MHz PCI compliance
- 3.3-V, 64-bit, 133 MHz PCI-X 1.0 compliance
- JTAG boundary-scan test (BST) support
- On-chip driver series termination (non-calibrated)
- Output drive strength control
- Tri-state buffers
- Bus-hold circuitry
- Programmable pull-up resistors
- Open-drain outputs
- PCI clamping diode (supported on the bottom I/O pins only)
- Double data rate (DDR) registers

General purpose IOEs support the following I/O standards:

- 3.3-V LVTTTL/LVCMOS
- 2.5-V LVTTTL/LVCMOS
- 1.8-V LVTTTL/LVCMOS
- 1.5-V LVCMOS
- 3.3-V PCI
- 3.3-V PCI-X mode 1

The general purpose CLK and PLL_FB input pins and the PLL_OUT output pins support the following I/O standards:

- LVDS
- HyperTransport technology
- LVPECL (on input clocks and PLL_OUT only)

The programmable drive strengths available vary depending on the I/O standard being used and are listed in [Table 2-10](#).

I/O Standard	Programmable Drive Strength Options (mA)
3.3-V LVTTTL	4, 8, 12
3.3-V LVCMOS	4, 8
2.5-V LVTTTL/LVCMOS	4, 8, 12

Table 2–10. Programmable Drive Strength Support for General-Purpose IOEs (Part 2 of 2)

I/O Standard	Programmable Drive Strength Options (mA)
1.8 V LVTTTL/LVCMOS	2, 4, 6, 8
1.5 V LVCMOS	2, 4

General purpose IOEs support non-calibrated on-chip series termination. 50- and 25- Ω on-chip series termination is available for 3.3-V or 2.5-V I/O standards. 50- Ω on-chip series termination is available for 1.8- and 1.5-V I/O standards (pending characterization).

Memory Interface IOE

Memory interface IOEs in HC210 and HC220 devices are located on the top of the device. Memory interface IOEs in HC230 and HC240 devices are located on the top and the bottom of the device. In Stratix II FPGAs, the top and bottom IOEs support the memory interface IOE features.

The memory interface IOE has many features, including:

- Dedicated single-ended I/O buffers
- 3.3-V, 64-bit, 66 MHz PCI compliance
- 3.3-V, 64-bit, 133 MHz PCI-X 1.0 compliance
- JTAG BST support
- On-chip driver series termination
- V_{REF} pins
- Output drive strength control
- Tri-state buffers
- Bus-hold circuitry
- Programmable pull-up resistors
- Open-drain outputs
- PCI clamping diode
- DQ and DQS I/O pins
- Double data rate (DDR) registers

The following I/O standards are supported when using the memory interface IOEs and can be used to interface to external memory, including DDR and DDR2 SDRAM, and QDR II, RLDRAM II, and SDR SRAM:

- 3.3-V LVTTTL/LVCMOS
- 2.5-V LVTTTL/LVCMOS
- 1.8-V LVTTTL/LVCMOS
- 1.5-V LVCMOS
- 3.3-V PCI
- 3.3-V PCI-X mode 1

- SSTL-2 class I and II
- SSTL-18 class I and II
- 1.8-V HSTL class I and II
- 1.5-V HSTL class I and II

The memory interface DQS, CLK, and PLL_FB input pins and the PLL_OUT output pins support the following I/O standards:

- LVTTTL/LVCMOS
- SSTL-2 class I and II
- SSTL-18 class I and II
- 1.8-V HSTL class I and II
- 1.5-V HSTL class I and II
- Differential SSTL-2 class I and II
- Differential SSTL-18 class I and II
- 1.8-V differential HSTL class I and II
- 1.5-V differential HSTL class I and II
- LVDS (not supported on DQS pins)
- HyperTransport technology (not supported on DQS pins)
- LVPECL on input clocks and PLL_OUT only (not supported on DQS pins)

Pseudo-differential HSTL and SSTL inputs are supported on clock and DQS pins, while outputs are supported on dedicated PLL_OUT and DQS pins. Pseudo-differential HSTL and SSTL I/O standards use two single-ended outputs with the second output programmed as inverted. Pseudo-differential HSTL and SSTL inputs treat differential inputs as two single-ended HSTL and SSTL inputs and only decode one of them. This I/O support is the same as in Stratix II FPGAs.

The functionality of all DQS circuitry in HardCopy II devices is the same as in Stratix II FPGAs. [Table 2-11](#) shows the number of DQS/DQ groups supported in each HardCopy II device density and package.

Table 2-11. DQS and DQ Bus Mode Support (Part 1 of 2)

Device	Package	Number of ×4 Groups	Number of ×8/×9 Groups	Number of ×16/×18 Groups	Number of ×32/×36 Groups
HC210W	484-pin FineLine BGA (Wire Bond)	4	2	0	0
HC210	484-pin FineLine BGA	4	2	0	0
HC220	672-pin FineLine BGA	9	4	2	0
	780-pin FineLine BGA	9	4	2	0
HC230	1,020-pin FineLine BGA	36	18	8	4

Table 2–11. DQS and DQ Bus Mode Support (Part 2 of 2)

Device	Package	Number of $\times 4$ Groups	Number of $\times 8/\times 9$ Groups	Number of $\times 16/\times 18$ Groups	Number of $\times 32/\times 36$ Groups
HC240	1,020-pin FineLine BGA	36	18	8	4
	1,508-pin FineLine BGA	36	18	8	4

The programmable drive strengths available vary depending on the I/O standard used. The options are listed in [Table 2–12](#).

Table 2–12. Programmable Drive Strength Support for Memory Interface IOEs

I/O Standard	Programmable Drive Strength Options (mA)
3.3-V LVTTTL	4, 8, 12, 16, 20, 24
3.3-V LVCMOS	4, 8, 12, 16, 20, 24
2.5-V LVTTTL/LVCMOS	4, 8, 12, 16
1.8-V LVTTTL/LVCMOS	2, 4, 6, 8, 10, 12
1.5-V LVCMOS	2, 4, 6, 8
SSTL-2 class I	8, 12
SSTL-2 class II	16, 20, 24
SSTL-18 class I	4, 6, 8, 10, 12
SSTL-18 class II	8, 16, 18, 20
1.8-V HSTL class I	4, 6, 8, 10, 12
1.8-V HSTL class II	16, 18, 20
1.5-V HSTL class I	4, 6, 8, 10, 12
1.5-V HSTL class II	16, 18, 20

Memory interface IOEs support both non-calibrated and calibrated on-chip series termination. 50- and 25- Ω on-chip series termination is available for 3.3-, 2.5-, or 1.8-V I/O standards. 50- Ω on-chip series termination is available for 1.5- or 1.2-V I/O standards (pending characterization).



If on-chip series termination is enabled, programmable drive strength support is not available.

High-Speed IOE

High-speed IOEs in HC210, HC220, and HC230 devices are located on the left side of the device. High-speed IOEs in HC240 devices are located on the left and right sides of the device. (Directions are based on a top view of the silicon die.) Unlike Stratix II left and right side I/O pins, HardCopy II left and right side I/O pins do not support SSTL or HSTL I/O standards or the PCI clamping diode. In Stratix II FPGAs, the right and left IOEs support the high-speed IOE features.

The high-speed IOE has many features, including:

- Dedicated single-ended I/O buffers
- Differential I/O buffer
- JTAG BST support
- On-chip driver series termination (non-calibrated)
- On-chip termination for differential I/O standards
- Output drive strength control
- Tri-state buffers
- Bus-hold circuitry
- Programmable pull-up resistors
- Open-drain outputs
- Transmit serializer
- Receive deserializer
- Dynamic phase alignment (DPA)
- Double data rate (DDR) registers

The following I/O standards are supported when using high-speed IOEs:

- 3.3-V LVTTTL/LVCMOS
- 2.5-V LVTTTL/LVCMOS
- 1.8-V LVTTTL/LVCMOS
- 1.5-V LVCMOS
- LVDS
- HyperTransport technology

The SERDES and DPA circuitry and functionality is the same in HardCopy II devices as in Stratix II FPGAs. HardCopy II devices support differential I/O standards at rates up to 1 Gbps when using DPA, and at rates up to 840 Mbps when not using DPA. [Table 2–13](#) provides the number of differential channels per HardCopy II device.

Table 2–13. Number of Differential Channels in HardCopy II Devices *Notes (1), (2)*

Channel	HC210W	HC210	HC220		HC230	HC240	
	484-Pin FineLine BGA (Wire-Bond)	484-Pin FineLine BGA	672-Pin FineLine BGA	780-Pin FineLine BGA	1,020-Pin FineLine BGA	1,020-Pin FineLine BGA	1,508-Pin FineLine BGA
Transmitter channels	13	19	29	29	44	88	116
Receiver channels	17	21	31	31	46	92	116

Notes to [Table 2–13](#):

- (1) The pin count does not include dedicated PLL input and output pins.
- (2) The total number of receiver channels includes the non-dedicated clock channels that can optionally be used as data channels.

HardCopy II high-speed IOEs, which are on the left and/or right sides of the device, support fewer programmable drive strengths than Stratix II side IOEs. The programmable drive strengths available vary depending on the I/O standard being used. The options are listed in [Table 2–14](#).

Table 2–14. Programmable Drive Strength Support for High-Speed IOEs

I/O Standard	Programmable Drive Strength Options (mA)
3.3-V LVTTTL	4, 8, 12
3.3-V LVCMOS	4, 8
2.5-V LVTTTL/LVCMOS	4, 8, 12
1.8-V LVTTTL/LVCMOS	2, 4, 6, 8
1.5-V LVCMOS	2, 4

High-speed IOEs support non-calibrated on-chip series termination and differential termination on the receiver channels. 50- and 25- Ω on-chip series termination is available for 3.3- or 2.5-V I/O standards. 50- Ω on-chip series termination is available for 1.8- and 1.5-V I/O standards (pending characterization).

Power-Up Modes

The functionality of structured ASICs is determined before they are produced. Therefore, they do not require programmability. HardCopy II structured ASICs follow the same principle, enabling traditional ASIC-like power up. Although prototyping FPGAs require configuration upon power up, the HardCopy II structured ASICs do not need to be configured. HardCopy II devices do not support configuration and designers should take this into account in the prototyping-to-production development process. The HardCopy II device does not require a configuration device, but you must ensure that the *nCE* pin is low and that the *nCONFIG* and *nSTATUS* pins are high after power up.



HardCopy II devices do not support FPGA configuration emulation and other configuration modes, including remote system upgrades and design security using configuration bitstream encryption.

HardCopy II devices support both instant on and instant on after 50 ms power-up modes. In the instant on power-up mode, the HardCopy II device is available for use shortly after the device powers up to a safe operating voltage. The on-chip power-on reset (POR) circuit will reset all registers. The *nCE*, *nCONFIG*, and *nSTATUS* signals must be at the appropriate logic levels for the *CONF_DONE* output to be tristated once the POR has elapsed. This option is similar to an ASIC's functionality upon power up and is the most likely scenario in production.

In the instant on after 50 ms power-up mode, the HardCopy II device behaves similarly to the instant on mode, except that there is an additional delay of 50 ms, during which time the device will be held in reset. The *CONF_DONE* output is pulled low during this time, and then tri-stated after the 50 ms have elapsed.



For more information about which power-up modes HardCopy II devices support, refer to the *Power-Up Modes and Configuration Emulation in HardCopy Series Devices* chapter in the *HardCopy Series Handbook*.

Document Revision History

Table 2–15 shows the revision history for this chapter.

Date and Document Version	Changes Made	Summary of Changes
September 2008, v2.5	Updated chapter number and metadata.	—
June 2007, v2.4	<ul style="list-style-type: none"> ● Added Note 4 to Table 2–4. 	—
December 2006 v2.3	<ul style="list-style-type: none"> ● Updated Table 2–1, Table 2–4, and Table 2–11. ● Added revision history. 	—
March 2006, v2.2	<ul style="list-style-type: none"> ● Updated Table 2–1, Table 2–9, Table 2–13. ● Updated Figure 2–5 and Figure 2–6. 	—
October 2005, v2.1	Updated graphics.	—
May 2005, v2.0	<ul style="list-style-type: none"> ● Added Table 2–1. ● Updated HCell information for DSP functions in the Functional Description section. ● Updated Table 2–9. ● Updated Figures 2–4, 2–5, and 2–6. 	—
January 2005, v1.0	Added document to the HardCopy Series Handbook.	—

IEEE Std. 1149.1 (JTAG) Boundary-Scan Support

All HardCopy[®] II structured ASICs provide Joint Test Action Group (JTAG) boundary-scan test (BST) circuitry that complies with the IEEE Std. 1149.1-1990 specification. The BST architecture offers the capability to efficiently test components on printed circuit boards (PCBs) with tight lead spacing by testing pin connections, without using physical test probes, and capturing functional data while a device is in normal operation. Boundary-scan cells in a device can force signals onto pins, or capture data from pin or core logic signals. Forced test data is serially shifted into the boundary-scan cells. Captured data is serially shifted out and externally compared to expected results.

A device using the JTAG interface uses four required pins, TDI, TDO, TMS, and TCK, and one optional pin, TRST. The TCK pin has an internal weak pull-down resistor, while the TDI, TMS, and TRST pins have weak internal pull-up resistors. The TDO output is powered by V_{CCIO}. HardCopy II devices support the JTAG instructions shown in [Table 3-1](#).

Table 3-1. HardCopy II JTAG Instructions (Part 1 of 2)

JTAG Instruction	Instruction Code	Description
SAMPLE/PRELOAD	00 0000 0101	Allows a snapshot of signals at the device pins to be captured and examined during normal device operation, and permits an initial data pattern to be output at the device pins.
EXTEST (1)	00 0000 1111	Allows the external circuitry and board-level interconnects to be tested by forcing a test pattern at the output pins and capturing test results at the input pins.
BYPASS	11 1111 1111	Places the 1-bit BYPASS register between the TDI and TDO pins, which allows the BST data to pass synchronously through selected devices to adjacent devices during normal device operation.

JTAG Instruction	Instruction Code	Description
USERCODE	00 0000 0111	Selects the 32-bit USERCODE register and places it between the TDI and TDO pins, allowing the USERCODE to be serially shifted out of TDO.
IDCODE	00 0000 0110	Selects the IDCODE register and places it between TDI and TDO, allowing the IDCODE to be serially shifted out of TDO.
HIGHZ (1)	00 0000 1011	Places the 1-bit BYPASS register between the TDI and TDO pins, which allows the BST data to pass synchronously through selected devices to adjacent devices during normal device operation, while tri-stating all of the I/O pins.
CLAMP (1)	00 0000 1010	Places the 1-bit BYPASS register between the TDI and TDO pins, which allows the BST data to pass synchronously through selected devices to adjacent devices during normal device operation while holding I/O pins to a state defined by the data in the boundary-scan register.

Note to Table 3–1:

- (1) Bus hold and weak pull-up resistor features override the high-impedance state of HIGHZ, CLAMP, and EXTEST.



The BSDL files for HardCopy II devices are different from the corresponding Stratix® II FPGAs. For more information, or to receive BSDL files for IEEE Std. 1149.1- compliant Hardcopy II devices, visit the Altera website at www.altera.com.

The HardCopy II device instruction register length is 10 bits and the USERCODE register length is 32 bits. The USERCODE registers are not reprogrammable and are mask-programmed. The designer can choose an appropriate 32 bit sequence which will be programmed into the USERCODE registers.

Tables 3–2 and 3–3 show the boundary-scan register length and device IDCODE information for HardCopy II devices.

Table 3–2. HardCopy II Boundary-Scan Register Length

Device	Boundary-Scan Register Length
HC210W	1050
HC210	1050
HC220	1530
HC230	2154
HC240	2910

Table 3–3. 32-Bit HardCopy II Device IDCODE

Device	IDCODE (32 Bits) (1)			
	Version (4 Bits)	Part Number (16 Bits)	Manufacturer Identity (11 Bits)	LSB (1 Bit) (2)
HC210W	0000	0010 0000 1100 0001	000 0110 1110	1
HC210	0000	0010 0000 1100 0010	000 0110 1110	1
HC220	0000	0010 0000 1100 0011	000 0110 1110	1
HC230	0000	0010 0000 1100 0100	000 0110 1110	1
HC240	0000	0010 0000 1100 0101	000 0110 1110	1

Notes to Table 3–3:

- (1) The most significant bit (MSB) is on the left.
- (2) The least significant bit (LSB) of IDCODE is always 1.

Boundary-Scan Test (BST) on HardCopy II Devices

In order to run the boundary-scan test on HardCopy II devices, you need two files:

1. The generic HardCopy II BSDL file you can download from the Altera website at www.altera.com.
2. The PIN file for your design from the Quartus II software.

With these two files, you must run through a tool called the BSDLCustomizer.

BSDLCustomizer is a TCL script which is used to modify the BSDL file's port definitions and boundary-scan chain groups' attributes according to the design and pin assignments from the Quartus II software PIN file.

Once you run the generic BSDL file and your PIN file through the BSDLCustomizer tool, a modified BSDL file is created which should be used for the boundary-scan test.

Before running the boundary scan test on your board make sure that the nCONFIG pin is externally pulled low and that the nSTATUS pin is low.

For more information on the BSDLCustomizer tool, refer to the *BSDLCustomizer User Guide* that you can download with the BSDLCustomizer tool from the Altera website at www.altera.com.

Figure 3–1 shows the timing requirements for the JTAG signals.

Figure 3–1. HardCopy II JTAG Waveforms

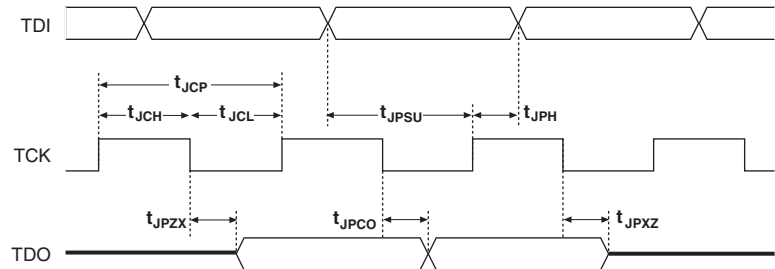

Table 3–4 shows the JTAG timing parameters and values for HardCopy II devices.

Symbol	Parameter	Min	Max	Unit
t_{JCP}	TCK clock period	30		ns
t_{JCH}	TCK clock high time	13		ns
t_{JCL}	TCK clock low time	13		ns
t_{JPSU}	JTAG port setup time	3		ns

Table 3–4. HardCopy II JTAG Timing Parameters and Values (Part 2 of 2)

Symbol	Parameter	Min	Max	Unit
t_{JPH}	JTAG port hold time	5		ns
t_{JPCO}	JTAG port clock to output		11	ns
t_{JPZX}	JTAG port high impedance to valid output		14	ns
t_{JPXZ}	JTAG port valid output to high impedance		14	ns
t_{JSSU}	Capture register setup time	4		ns
t_{JSH}	Capture register hold time	5		ns



For more information on JTAG or boundary-scan testing, refer to AN 39: *IEEE Std. 1149.1 (JTAG) Boundary-Scan Testing in Altera Devices*.



Like Stratix II FPGAs, HardCopy II devices support the SignalTap® II embedded logic analyzer, which monitors design operation over a period of time through the JTAG interface. The SignalTap II logic analyzer is a useful feature during the FPGA prototyping phase, but should be removed if not needed once the design has been migrated to a HardCopy II device. HardCopy II is a mask programmed device, and the Signal Tap logic cannot be eliminated after the HardCopy II device is fabricated.

Document Revision History

Table 3–5 shows the revision history for this chapter.

Table 3–5. Document Revision History (Part 1 of 2)

Date and Document Version	Changes Made	Summary of Changes
September 2008, v2.4	Updated chapter number and metadata.	—
June 2007, v2.3	<ul style="list-style-type: none"> • Added resource information • Figure 3–1 changes • New section on Boundary-Scan Test (BST) on HardCopy II devices. 	—
December 2006 v2.2	<ul style="list-style-type: none"> • Minor updates for Quartus II 6.1.0 software version • Added revision history 	Updated for Quartus II 6.1 software version.
October 2005, v2.1	Updated graphics.	—

Table 3–5. Document Revision History (Part 2 of 2)

Date and Document Version	Changes Made	Summary of Changes
May 2005, v2.0	Updated Table 3-2.	—
January 2005 v1.0	Added document to the HardCopy Series Handbook.	—

Introduction

This chapter provides preliminary information on absolute maximum ratings, recommended operating conditions, DC electrical characteristics, and other specifications for HardCopy® II devices.

Absolute Maximum Ratings

HardCopy II devices are offered in both commercial and industrial grades. All parameter limits are representative of worst-case supply voltage and junction temperature conditions. Unless otherwise noted, the parameter values in this chapter apply to all HardCopy II devices. [Table 4-1](#) contains the absolute maximum ratings for the HardCopy II device family.

Table 4-1. HardCopy II Device Absolute Maximum Ratings *Notes (1), (2), (3)*

Symbol	Parameter	Conditions	Minimum	Maximum	Unit
V _{CCINT}	Supply voltage	With respect to ground	-0.5	1.8	V
V _{CCIO}	Supply voltage	With respect to ground	-0.5	4.6	V
V _{CCPD}	Supply voltage	With respect to ground	-0.5	4.6	V
V _{CCA}	Analog power supply for PLLs	With respect to ground	-0.5	1.8	V
V _{CCD}	Digital power supply for PLLs	With respect to ground	-0.5	1.8	V
V _I	DC input voltage(4)	—	-0.5	4.6	V
I _{OUT}	DC output current, per pin	—	-25	40	mA
T _{STG}	Storage temperature	No bias	-65	150	°C
T _J	Junction temperature	Ball-grid array (BGA) packages under bias	-55	125	°C

Notes to Table 4-1:

- (1) Refer to the *Operating Requirements for Altera Devices Data Sheet* for more information.
- (2) Conditions beyond those listed in [Table 4-1](#) may cause permanent damage to a device. Additionally, device operation at the absolute maximum ratings for extended periods of time may have adverse effects on the device.
- (3) Supply voltage specifications apply to voltage readings taken at the device pins, not at the power supply.
- (4) During transitions, the inputs may overshoot to the voltage shown in [Table 4-2](#) based upon the input duty cycle. The DC case is equivalent to a 100% duty cycle. During transitions, the inputs may undershoot to -2.0 V for input currents less than 100 mA and periods shorter than 20 ns.

Table 4–2. Maximum Duty Cycles in Voltage Transitions

V_{IN} (V)	Maximum Duty Cycles
4	100%
4.1	90%
4.2	50%
4.3	30%
4.4	17%
4.5	10%

Recommended Operating Conditions

Table 4–3 contains the HardCopy II device family’s recommended operating conditions.

Table 4–3. HardCopy II Device Recommended Operating Conditions Note (1) (Part 1 of 2)

Symbol	Parameter	Conditions	Minimum	Maximum	Unit
V_{CCINT}	Supply voltage for internal logic and input buffers	$100\ \mu\text{s} \leq \text{rise time} \leq 100\ \text{ms}$ (2)	1.15	1.25	V
V_{CCIO}	Supply voltage for output buffers, 3.3-V operation	$100\ \mu\text{s} \leq \text{rise time} \leq 100\ \text{ms}$ (2), (6)	3.135 (3.0)	3.465 (3.6)	V
	Supply voltage for output buffers, 2.5-V operation	$100\ \mu\text{s} \leq \text{rise time} \leq 100\ \text{ms}$ (2)	2.375	2.625	V
	Supply voltage for output buffers, 1.8-V operation	$100\ \mu\text{s} \leq \text{rise time} \leq 100\ \text{ms}$ (2)	1.71	1.89	V
	Supply voltage for output buffers, 1.5-V operation	$100\ \mu\text{s} \leq \text{rise time} \leq 100\ \text{ms}$ (2)	1.425	1.575	V
V_{CCPD}	Supply voltage for pre-drivers as well as configuration and JTAG I/O buffers	$100\ \mu\text{s} \leq \text{rise time} \leq 100\ \text{ms}$ (3)	3.135	3.465	V
V_{CCA}	Analog power supply for PLLs	$100\ \mu\text{s} \leq \text{rise time} \leq 100\ \text{ms}$ (3)	1.15	1.25	V
V_{CCD}	Digital power supply for PLLs	$100\ \mu\text{s} \leq \text{rise time} \leq 100\ \text{ms}$ (3)	1.15	1.25	V
V_I	Input voltage	(4), (5)	-0.5	4.0	V
V_O	Output voltage	—	0	V_{CCIO}	V

Table 4–3. HardCopy II Device Recommended Operating Conditions *Note (1) (Part 2 of 2)*

Symbol	Parameter	Conditions	Minimum	Maximum	Unit
T _J	Operating junction temperature	For commercial use	0	85	°C
		For industrial use	-40	100	°C

Notes to Table 4–3:

- (1) Supply voltage specifications apply to voltage readings taken at the device pins, not at the power supply.
- (2) Maximum V_{CC} rise time is 100 ms, and V_{CC} must rise monotonically.
- (3) V_{CCPD} must ramp-up from 0 V to 3.3 V within 100 μs to 100 ms. If V_{CCPD} is not ramped up within this specified time, the HardCopy II device will not power up successfully.
- (4) During transitions, the inputs may overshoot to the voltage shown in Table 4–2 based upon the input duty cycle. The DC case is equivalent to a 100% duty cycle. During transitions, the inputs may undershoot to –2.0 V for input currents less than 100 mA and periods shorter than 20 ns.
- (5) All pins, including dedicated inputs, clock, I/O, and JTAG pins, may be driven before V_{CCINT}, V_{CCPD}, and V_{CCIO} are powered.
- (6) V_{CCIO} maximum and minimum conditions for PCI and PCI-X are shown in parentheses.

DC Electrical Characteristics

Table 4–4 shows the HardCopy II device family’s DC electrical characteristics.

Table 4–4. HardCopy II Device DC Operating Conditions *Note (1) (Part 1 of 2)*

Symbol	Parameter	Conditions	Device	Minimum	Typical	Maximum	Unit
I _I	Input pin leakage current	V _I = V _{CCIO} max to 0 V (2)	all	-10	—	10	μA
I _{OZ}	Tri-stated I/O pin leakage current	V _O = V _{CCIO} max to 0 V (2)	all	-10	—	10	μA
I _{CCINT0}	V _{CCINT} supply current (standby)	V _I = ground, no load, no toggling inputs T _J = 25° C	HC210W	—	0.09 (3)	(5)	A
			HC210	—	0.09 (3)	(5)	A
			HC220	—	0.19 (3)	(5)	A
			HC230	—	0.34 (3)	(5)	A
			HC240	—	0.52 (3)	(5)	A
I _{CCPD0}	V _{CCPD} supply current (standby)	V _I = ground, no load, no toggling inputs T _J = 25° C V _{CCPD} = 3.3 V	HC210W	—	3 (3)	(5)	mA
			HC210	—	3 (3)	(5)	mA
			HC220	—	4 (3)	(5)	mA
			HC230	—	5 (3)	(5)	mA
			HC240	—	5 (3)	(5)	mA

Symbol	Parameter	Conditions	Device	Minimum	Typical	Maximum	Unit
I_{CCIO0}	V_{CCIO} supply current (standby)	$V_I = \text{ground, no load, no toggling inputs}$ $T_J = 25^\circ \text{C}$	HC210W	—	3 (3)	(5)	mA
			HC210	—	3 (3)	(5)	mA
			HC220	—	3 (3)	(5)	mA
			HC230	—	3 (3)	(5)	mA
			HC240	—	3 (3)	(5)	mA
$R_{CONF(4)}$	Value of I/O pin pull-up resistor before and during configuration	$V_I = 0; V_{CCIO} = 3.3 \text{V}$	—	10	25	50	k Ω
		$V_I = 0; V_{CCIO} = 2.5 \text{V}$	—	15	35	70	k Ω
		$V_I = 0; V_{CCIO} = 1.8 \text{V}$	—	30	50	100	k Ω
		$V_I = 0; V_{CCIO} = 1.8 \text{V}$	—	40	75	150	k Ω
		$V_I = 0; V_{CCIO} = 1.2 \text{V}$	—	50	90	170	k Ω
	Recommended value of I/O pin external pull-down resistor before and during configuration	—	—	—	1	2	k Ω

Notes to Table 4–4:

- (1) Typical values are for $T_A = 25^\circ \text{C}$, $V_{CCINT} = 1.2 \text{V}$, and $V_{CCIO} = 1.5\text{-}, 1.8\text{-}, 2.5\text{-}, \text{ and } 3.3\text{-V}$.
- (2) This value is specified for normal device operation. The value may vary during power-up. This applies for all V_{CCIO} settings (3.3-, 2.5-, 1.8-, and 1.5-V).
- (3) This specification is preliminary and pending further device characterization.
- (4) Pin pull-up resistor values will lower if an external source drives the pin higher than V_{CCIO} .
- (5) Maximum values depend on the actual T_J and design utilization. See the *PowerPlay Early Power Estimator* or the *Quartus II PowerPlay Power Analyzer* feature for maximum values.

I/O Standard Specifications

Tables 4–5 through 4–27 show the HardCopy II device family's I/O standard specifications.

Symbol	Parameter	Conditions	Minimum	Maximum	Unit
$V_{CCIO(1)}$	Output-supply voltage	—	3.135	3.465	V
V_{IH}	High-level input voltage	—	1.7	4.0	V
V_{IL}	Low-level input voltage	—	-0.3	0.8	V
V_{OH}	High-level output voltage	$I_{OH} = -4 \text{mA}$ (2), (3)	2.4	—	V

Table 4–5. LVTTTL Specifications (Part 2 of 2)

Symbol	Parameter	Conditions	Minimum	Maximum	Unit
V_{OL}	Low-level output voltage	$I_{OL} = 4 \text{ mA}$ (2), (3)	—	0.45	V

Notes to Table 4–5:

- (1) HardCopy II devices comply to the narrow range for the supply voltage as specified in the EIA/JEDEC Standard, JESD8-B.
- (2) Drive strength is programmable according to values in Table 2–10, Table 2–12, and Table 2–14.
- (3) Drive strength varies based on pin location. Refer to the *Description, Architecture, and Features* chapter in the *HardCopy II Device Family Data Sheet* section of volume 1 of the *HardCopy Series Handbook* for more information.

Table 4–6. LVC MOS Specifications

Symbol	Parameter	Conditions	Minimum	Maximum	Unit
V_{CCIO} (1)	Output-supply voltage	—	3.135	3.465	V
V_{IH}	High-level input voltage	—	1.7	4.0	V
V_{IL}	Low-level input voltage	—	-0.3	0.8	V
V_{OH}	High-level output voltage	$V_{CCIO} = 3.0, I_{OH} = -0.1 \text{ mA}$ (2), (3)	$V_{CCIO} - 0.2$	—	V
V_{OL}	Low-level output voltage	$V_{CCIO} = 3.0, I_{OL} = 0.1 \text{ mA}$ (2), (3)	—	0.2	V

Notes to Table 4–6:

- (1) HardCopy II devices comply to the narrow range for the supply voltage as specified in the EIA/JEDEC Standard, JESD8-B.
- (2) Drive strength is programmable according to values in Tables 2–10, 2–12, and 2–14.
- (3) Drive strength varies based on pin location. Refer to the *Description, Architecture, and Features* chapter in the *HardCopy II Device Family Data Sheet* section in volume 1 of the *HardCopy Series Handbook* for more information.

Table 4–7. 2.5-V I/O Specifications (Part 1 of 2)

Symbol	Parameter	Conditions	Minimum	Maximum	Unit
V_{CCIO} (1)	Output-supply voltage	—	2.375	2.625	V
V_{IH}	High-level input voltage	—	1.7	4.0	V
V_{IL}	Low-level input voltage	—	-0.3	0.7	V
V_{OH}	High-level output voltage	$I_{OH} = -1 \text{ mA}$ (2), (3)	2.0	—	V

Table 4–7. 2.5-V I/O Specifications (Part 2 of 2)

Symbol	Parameter	Conditions	Minimum	Maximum	Unit
V _{OL}	Low-level output voltage	I _{OL} = 1 mA (2), (3)	—	0.4	V

Notes to Table 4–7:

- (1) HardCopy II devices V_{CCIO} voltage-level support of 2.5 ± -5% is narrower than defined in the normal range of the EIA/JEDEC Standard.
- (2) Drive strength is programmable according to values in Tables 2–10, 2–12, and 2–14.
- (3) Drive strength varies based on pin location. Refer to the *Description, Architecture, and Features* chapter in the *HardCopy II Device Family Data Sheet* section in volume 1 of the *HardCopy Series Handbook* for more information.

Table 4–8. 1.8-V I/O Specifications

Symbol	Parameter	Conditions	Minimum	Maximum	Unit
V _{CCIO} (1)	Output-supply voltage	—	1.71	1.89	V
V _{IH}	High-level input voltage	—	0.65 × V _{CCIO}	2.25	V
V _{IL}	Low-level input voltage	—	-0.3	0.35 × V _{CCIO}	V
V _{OH}	High-level output voltage	I _{OH} = -2 to -8 mA (2), (3)	V _{CCIO} - 0.45	—	V
V _{OL}	Low-level output voltage	I _{OL} = 2 to 8 mA (2), (3)	—	0.45	V

Notes to Table 4–8:

- (1) HardCopy II devices V_{CCIO} voltage-level support of 1.8 ± -5% is narrower than defined in the normal range of the EIA/JEDEC Standard.
- (2) Drive strength is programmable according to values in Tables 2–10, 2–12, and 2–14.
- (3) Drive strength varies based on pin location. Refer to the *Description, Architecture, and Features* chapter in the *HardCopy II Device Family Data Sheet* section in volume 1 of the *HardCopy Series Handbook* for more information.

Table 4–9. 1.5-V I/O Specifications (Part 1 of 2)

Symbol	Parameter	Conditions	Minimum	Maximum	Unit
V _{CCIO} (1)	Output-supply voltage	—	1.425	1.575	V
V _{IH}	High-level input voltage	—	0.65 × V _{CCIO}	V _{CCIO} + 0.3	V
V _{IL}	Low-level input voltage	—	-0.3	0.35 × V _{CCIO}	V
V _{OH}	High-level output voltage	I _{OH} = -2 mA (2), (3)	0.75 × V _{CCIO}	—	V

Table 4–9. 1.5-V I/O Specifications (Part 2 of 2)

Symbol	Parameter	Conditions	Minimum	Maximum	Unit
V_{OL}	Low-level output voltage	$I_{OL} = 2 \text{ mA}$ (2), (3)	—	$0.25 \times V_{CCIO}$	V

Notes to Table 4–9:

- (1) HardCopy II devices V_{CCIO} voltage-level support of $1.5 \pm -5\%$ is narrower than defined in the normal range of the EIA/JEDEC Standard.
- (2) Drive strength is programmable according to values in Tables 2–10, 2–12, and 2–14.
- (3) Drive strength varies based on pin location. Refer to the *Description, Architecture, and Features* chapter in the *HardCopy II Device Family Data Sheet* section in volume 1 of the *HardCopy Series Handbook* for more information.

Figure 4–1 and Figure 4–2 show receiver input and transmitter waveforms, respectively, for all differential I/O LVPECL and HyperTransport technology.

Figure 4–1. Receiver Input Waveforms for Differential I/O Standards

Figure 4–2. Transmitter Output Waveforms for Differential I/O Standards

Table 4–10. 2.5-V LVDS I/O Specifications

Symbol	Parameter	Conditions	Minimum	Typical	Maximum	Unit
V_{CCIO}	I/O supply voltage for I/O banks that support high-speed IOEs (1), (2)	— —	2.375	2.5	2.625	V
V_{ID}	Input differential voltage swing (single-ended)	—	100	350	900	mV
V_{ICM}	Input common mode voltage	—	200	1,250	1,800	mV
V_{OD}	Output differential voltage (single-ended)	$R_L = 100 \Omega$	250	—	450	mV
V_{OCM}	Output common mode voltage	$R_L = 100 \Omega$	1.125	—	1.375	V
R_L	Receiver differential input discrete resistor (external to HardCopy II devices)	—	90	100	110	Ω

Notes to Table 4–10:

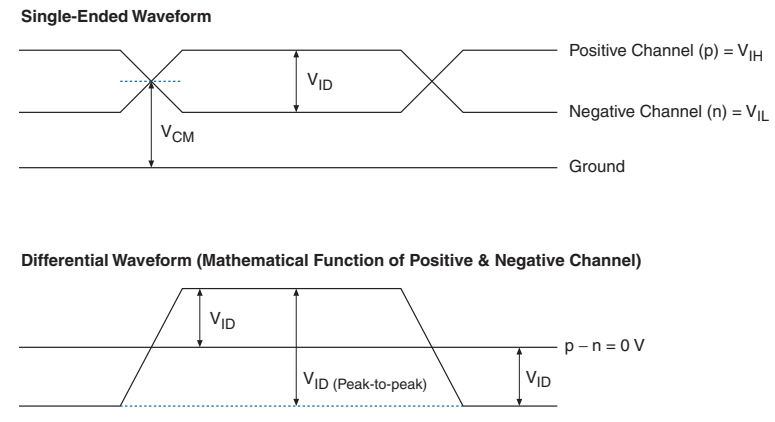
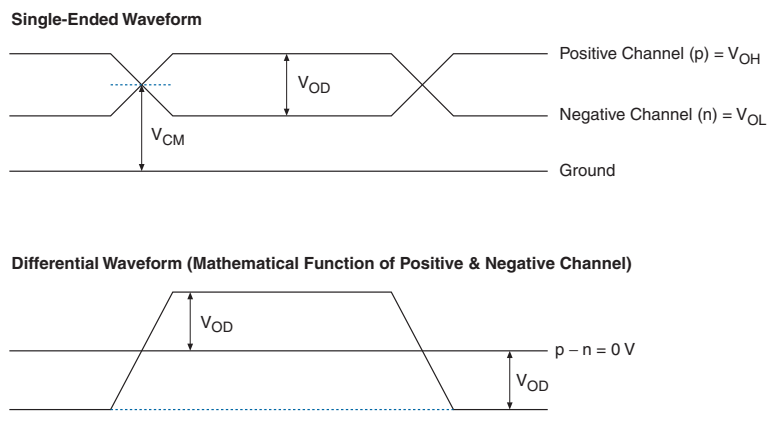
- (1) IOEs = I/O elements.
- (2) For information on which I/O banks support high-speed IOEs, refer to the *Description, Architecture, and Features* chapter in the *HardCopy II Device Family Data Sheet* section in volume 1 of the *HardCopy Series Handbook*.

Table 4–11. 3.3-V LVDS I/O Specifications *Note (1)*

Symbol	Parameter	Conditions	Minimum	Typical	Maximum	Unit
V _{CCIO}	Output and feedback pins in PLL banks 9, 10, 11, and 12 (2)	—	3.135	3.3	3.465	V
V _{ID}	Input differential voltage swing (single-ended)	—	100	350	900	mV
V _{ICM}	Input common mode voltage	—	200	1,250	1,800	mV
V _{OD}	Output differential voltage (single-ended)	R _L = 100 Ω	250	—	710	mV
V _{OCM}	Output common mode voltage	R _L = 100 Ω	0.84	—	1.570	V
R _L	Receiver differential input discrete resistor (external to HardCopy II devices)	—	90	100	110	Ω

Notes to Table 4–11:

- (1) Like Stratix II devices, 3.3-V LVDS is supported by the top and bottom clock input differential buffers, and by the PLL clock output and feedback pins.
- (2) The top and bottom clock input differential buffers in I/O banks 3, 4, 7, and 8 are powered by V_{CCINT}, not V_{CCIO}. The PLL clock output and feedback differential buffers are powered by V_{CC_PLL}. For differential clock output and feedback operation, connect V_{CC_PLL} to 3.3 V.

Table 4–12. LVPECL Specifications (Part 1 of 2) *Note (1)*

Symbol	Parameter	Conditions	Minimum	Typical	Maximum	Unit
V _{CCIO}	I/O supply voltage for I/O banks that support high-speed IOEs (2)	—	3.135	3.3	3.465	V
V _{ID} (peak-to-peak)	Input differential voltage swing (single-ended)	—	300	600	1,000	mV
V _{ICM}	Input common mode voltage	R _L = 100 Ω	1.0	—	2.5	mV
V _{OD}	Output differential voltage (single-ended)	R _L = 100 Ω	525	—	970	mV
V _{OCM}	Output common mode voltage	R _L = 100 Ω	1.650	—	2.275	V

Table 4–12. LVPECL Specifications (Part 2 of 2) Note (1)

Symbol	Parameter	Conditions	Minimum	Typical	Maximum	Unit
R_L	Receiver differential input discrete resistor (external to HardCopy II devices)	—	90	100	110	Ω

Notes to Table 4–12:

- Like Stratix II devices, LVPECL is supported by the top and bottom clock input differential buffers, and by the PLL clock output and feedback pins.
- The top and bottom clock input differential buffers in I/O banks 3, 4, 7, and 8 are powered by V_{CCINT} , not V_{CCIO} . The PLL clock output and feedback differential buffers are powered by $V_{CC_PFLLOUT}$. For differential clock output and feedback operation, connect $V_{CC_PFLLOUT}$ to 3.3 V.

Table 4–13. HyperTransport Technology Specifications

Symbol	Parameter	Conditions	Minimum	Typical	Maximum	Unit
V_{CCIO}	I/O supply voltage for I/O banks that support high-speed IOEs (1), (2)	—	2.375	2.5	2.625	V
	Output and feedback pins in PLL banks 9, 10, 11, and 12	—	3.135	3.3	3.465	V
V_{ID} (peak-to-peak)	Input differential voltage swing (single-ended)	—	300	600	900	mV
V_{ICM}	Input common mode voltage	—	385	600	845	mV
V_{OD}	Output differential voltage (single-ended)	$R_L = 100 \Omega$	400	600	820	mV
ΔV_{OD}	Change in V_{OD} between high and low	$R_L = 100 \Omega$	—	—	75	mV
V_{OCM}	Output common mode voltage	$R_L = 100 \Omega$	440	600	780	V
ΔV_{OCM}	Change in V_{OCM} between high and low	$R_L = 100 \Omega$	—	—	50	mV
R_L	Receiver differential input discrete resistor (external to HardCopy II devices)	—	90	100	110	Ω

Notes to Table 4–13:

- For information on which I/O banks support high-speed IOEs, refer to the *Description, Architecture, and Features* chapter in the *HardCopy II Device Family Data Sheet* section in volume 1 of the *HardCopy Series Handbook*.
- The top and bottom clock input differential buffers in I/O banks 3, 4, 7, and 8 are powered by V_{CCINT} , not V_{CCIO} . The PLL clock output and feedback differential buffers are powered by $V_{CC_PFLLOUT}$. For differential clock output and feedback operation, connect $V_{CC_PFLLOUT}$ to 3.3 V.

Table 4–14. 3.3-V PCI Specifications

Symbol	Parameter	Conditions	Minimum	Typical	Maximum	Unit
V_{CCIO}	Output-supply voltage	—	3	3.3	3.6	V
V_{IH}	High-level input voltage	—	$0.5 \times V_{CCIO}$	—	$V_{CCIO} + 0.5$	V
V_{IL}	Low-level input voltage	—	-0.3	—	$0.3 \times V_{CCIO}$	V
V_{OH}	High-level output voltage	$I_{OUT} = -500 \mu A$	$0.9 \times V_{CCIO}$	—	—	V
V_{OL}	Low-level output voltage	$I_{OUT} = 1,500 \mu A$	—	—	$0.1 \times V_{CCIO}$	V

Table 4–15. PCI-X Mode 1 Specifications

Symbol	Parameter	Conditions	Minimum	Typical	Maximum	Unit
V_{CCIO}	Output-supply voltage	—	3	—	3.6	V
V_{IH}	High-level input voltage	—	$0.5 \times V_{CCIO}$	—	$V_{CCIO} + 0.5$	V
V_{IL}	Low-level input voltage	—	-0.3	—	$0.35 \times V_{CCIO}$	V
V_{IPU}	Input pull-up voltage	—	$0.7 \times V_{CCIO}$	—	—	V
V_{OH}	High-level output voltage	$I_{OUT} = -500 \mu A$	$0.9 \times V_{CCIO}$	—	—	V
V_{OL}	Low-level output voltage	$I_{OUT} = 1,500 \mu A$	—	—	$0.1 \times V_{CCIO}$	V

Table 4–16. SSTL-18 Class I Specifications (Part 1 of 2)

Symbol	Parameter	Conditions	Minimum	Typical	Maximum	Unit
V_{CCIO}	Output-supply voltage	—	1.71	1.8	1.89	V
V_{REF}	Reference voltage	—	0.855	0.9	0.945	V
V_{TT}	Termination voltage	—	$V_{REF} - 0.04$	V_{REF}	$V_{REF} + 0.04$	V
$V_{IH(DC)}$	High-level DC input voltage	—	$V_{REF} + 0.125$	—	—	V
$V_{IL(DC)}$	Low-level DC input voltage	—	—	—	$V_{REF} - 0.125$	V
$V_{IH(AC)}$	High-level AC input voltage	—	$V_{REF} + 0.25$	—	—	V
$V_{IL(AC)}$	Low-level AC input voltage	—	—	—	$V_{REF} - 0.25$	V
V_{OH}	High-level output voltage	$I_{OH} = -6.7 \text{ mA } (1), (2)$	$V_{TT} + 0.475$	—	—	V

Table 4–16. SSTL-18 Class I Specifications (Part 2 of 2)

Symbol	Parameter	Conditions	Minimum	Typical	Maximum	Unit
V_{OL}	Low-level output voltage	$I_{OL} = 6.7 \text{ mA}$ (1), (2)	—	—	$V_{TT} - 0.475$	V

Notes to Table 4–16:

- (1) This specification is supported across all the programmable drive settings available for this I/O standard as shown in the *I/O Structure and Features* section located in the *Description, Architecture, and Features* chapter in volume 1 of the *HardCopy Series Devices Handbook*.
- (2) Drive strength varies based on pin location. Refer to the *Description, Architecture, and Features* chapter in the *HardCopy II Device Family Data Sheet* section in volume 1 of the *HardCopy Series Handbook* for more information.

Table 4–17. SSTL-18 Class II Specifications

Symbol	Parameter	Conditions	Minimum	Typical	Maximum	Unit
V_{CCIO}	Output-supply voltage	—	1.71	1.8	1.89	V
V_{REF}	Reference voltage	—	0.855	0.9	0.945	V
V_{TT}	Termination voltage	—	$V_{REF} - 0.04$	V_{REF}	$V_{REF} + 0.04$	V
$V_{IH(DC)}$	High-level DC input voltage	—	$V_{REF} + 0.125$	—	—	V
$V_{IL(DC)}$	Low-level DC input voltage	—	—	—	$V_{REF} - 0.125$	V
$V_{IH(AC)}$	High-level AC input voltage	—	$V_{REF} + 0.25$	—	—	V
$V_{IL(AC)}$	Low-level AC input voltage	—	—	—	$V_{REF} - 0.25$	V
V_{OH}	High-level output voltage	$I_{OH} = -13.4 \text{ mA}$ (1), (2)	$V_{TT} - 0.28$	—	—	V
V_{OL}	Low-level output voltage	$I_{OL} = 13.4 \text{ mA}$ (1), (2)	—	—	0.28	V

Notes to Table 4–17:

- (1) This specification is supported across all the programmable drive settings available for this I/O standard as shown in the *I/O Structure and Features* section located in the *Description, Architecture, and Features* chapter in volume 1 of the *HardCopy Series Devices Handbook*.
- (2) Drive strength varies based on pin location. Refer to the *Description, Architecture, and Features* chapter in the *HardCopy II Device Family Data Sheet* section in volume 1 of the *HardCopy Series Handbook* for more information.

Table 4–18. SSTL-18 Differential Specifications (Part 1 of 2)

Symbol	Parameter	Conditions	Minimum	Typical	Maximum	Unit
V_{CCIO}	Output-supply voltage	—	1.71	1.8	1.89	V
$V_{SWING(DC)}$	DC differential input voltage	—	0.25	—	—	V

Table 4–18. SSTL-18 Differential Specifications (Part 2 of 2)

Symbol	Parameter	Conditions	Minimum	Typical	Maximum	Unit
$V_{X(AC)}$	AC differential input cross point voltage	—	$(V_{CCIO/2}) - 0.175$	—	$(V_{CCIO/2}) + 0.175$	V
$V_{SWING(AC)}$	AC differential input voltage	—	0.5	—	—	V
V_{ISO}	Input clock signal offset voltage	—	—	$0.5 \times V_{CCIO}$	—	V
ΔV_{ISO}	Input clock signal offset voltage variation	—	—	± 200	—	V
$V_{OX(AC)}$	AC differential cross point voltage	—	$(V_{CCIO/2}) - 0.125$	—	$(V_{CCIO/2}) + 0.125$	V

Table 4–19. SSTL-2 Class I Specifications

Symbol	Parameter	Conditions	Minimum	Typical	Maximum	Unit
V_{CCIO}	Output-supply voltage	—	2.375	2.5	2.625	V
V_{TT}	Termination voltage	—	$V_{REF} - 0.04$	V_{REF}	$V_{REF} + 0.04$	V
V_{REF}	Reference voltage	—	1.188	1.25	1.313	V
$V_{IH(DC)}$	High-level input voltage	—	$V_{REF} + 0.18$	—	3.0	V
$V_{IL(DC)}$	Low-level input voltage	—	-0.3	—	$V_{REF} - 0.18$	V
$V_{IH(AC)}$	High-level input voltage	—	$V_{REF} + 0.35$	—	—	V
$V_{IL(AC)}$	Low-level input voltage	—	—	—	$V_{REF} - 0.35$	V
V_{OH}	High-level output voltage	$I_{OH} = -8.1 \text{ mA (1), (2)}$	$V_{TT} + 0.57$	—	—	V
V_{OL}	Low-level output voltage	$I_{OL} = 8.1 \text{ mA (1), (2)}$	—	—	$V_{TT} - 0.57$	V

Notes to Table 4–19:

- (1) This specification is supported across all the programmable drive settings available for this I/O standard as shown in the *I/O Structure and Features* section of the *Description, Architecture, and Features* chapter in volume 1 of the *HardCopy Series Devices Handbook*.
- (2) Drive strength varies based on pin location. Refer to the *Description, Architecture, and Features* chapter in the *HardCopy II Device Family Data Sheet* section in volume 1 of the *HardCopy Series Handbook* for more information.

Table 4–20. SSTL-2 Class II Specifications

Symbol	Parameter	Conditions	Minimum	Typical	Maximum	Unit
V_{CCIO}	Output-supply voltage	—	2.375	2.5	2.625	V
V_{TT}	Termination voltage	—	$V_{REF} - 0.04$	V_{REF}	$V_{REF} + 0.04$	V
V_{REF}	Reference voltage	—	1.188	1.25	1.313	V
$V_{IH(DC)}$	High-level input voltage	—	$V_{REF} + 0.18$	—	$V_{CCIO} + 0.3$	V
$V_{IL(DC)}$	Low-level input voltage	—	-0.3	—	$V_{REF} - 0.18$	V
$V_{IH(AC)}$	High-level input voltage	—	$V_{REF} + 0.35$	—	—	V
$V_{IL(AC)}$	Low-level input voltage	—	—	—	$V_{REF} - 0.35$	V
V_{OH}	High-level output voltage	$I_{OH} = -16.4 \text{ mA (1), (2)}$	$V_{TT} + 0.76$	—	—	V
V_{OL}	Low-level output voltage	$I_{OL} = 16.4 \text{ mA (1), (2)}$	—	—	$V_{TT} - 0.76$	V

Notes to Table 4–20:

- (1) This specification is supported across all the programmable drive settings available for this I/O standard as shown in the *I/O Structure and Features* section located in the *Description, Architecture, and Features* chapter in volume 1 of the *HardCopy Series Devices Handbook*.
- (2) Drive strength varies based on pin location. Refer to the *Description, Architecture, and Features* chapter in the *HardCopy II Device Family Data Sheet* section in volume 1 of the *HardCopy Series Handbook* for more information.

Table 4–21. SSTL-2 Differential Specifications

Symbol	Parameter	Conditions	Minimum	Typical	Maximum	Unit
V_{CCIO}	Output-supply voltage	—	2.375	2.5	2.625	V
$V_{SWING(DC)}$	DC differential input voltage	—	0.36	—	—	V
$V_X(AC)$	AC differential input cross point voltage	—	$(V_{CCIO/2}) - 0.2$	—	$(V_{CCIO/2}) + 0.2$	V
$V_{SWING(AC)}$	AC differential input voltage	—	0.7	—	—	V
V_{ISO}	Input clock signal offset voltage	—	—	$0.5 \times V_{CCIO}$	—	V
ΔV_{ISO}	Input clock signal offset voltage variation	—	—	± 200	—	V
$V_{OX(AC)}$	AC differential output cross point voltage	—	$(V_{CCIO/2}) - 0.2$	—	$(V_{CCIO/2}) + 0.2$	V

Table 4–22. 1.5-V HSTL Class I Specifications

Symbol	Parameter	Conditions	Minimum	Typical	Maximum	Unit
V_{CCIO}	Output-supply voltage	—	1.425	1.5	1.575	V
V_{REF}	Input reference voltage	—	0.713	0.75	0.788	V
V_{TT}	Termination voltage	—	0.713	0.75	0.788	V
$V_{IH(DC)}$	DC high-level input voltage	—	$V_{REF} + 0.1$	—	—	V
$V_{IL(DC)}$	DC low-level input voltage	—	-0.3	—	$V_{REF} - 0.1$	V
$V_{IH(AC)}$	AC high-level input voltage	—	$V_{REF} + 0.2$	—	—	V
$V_{IL(AC)}$	AC low-level input voltage	—	—	—	$V_{REF} - 0.2$	V
V_{OH}	High-level output voltage	$I_{OH} = 8 \text{ mA (1), (2)}$	$V_{CCIO} - 0.4$	—	—	V
V_{OL}	Low-level output voltage	$I_{OL} = -8 \text{ mA (1), (2)}$	—	—	0.4	V

Notes to Table 4–22:

- (1) This specification is supported across all the programmable drive settings available for this I/O standard as shown in the *I/O Structure and Features* section located in the *Description, Architecture, and Features* chapter in volume 1 of the *HardCopy Series Devices Handbook*.
- (2) Drive strength varies based on pin location. Refer to the *Description, Architecture, and Features* chapter in the *HardCopy II Device Family Data Sheet* section in volume 1 of the *HardCopy Series Handbook* for more information.

Table 4–23. 1.5-V HSTL Class II Specifications (Part 1 of 2)

Symbol	Parameter	Conditions	Minimum	Typical	Maximum	Unit
V_{CCIO}	Output-supply voltage	—	1.425	1.5	1.575	V
V_{REF}	Input reference voltage	—	0.713	0.75	0.788	V
V_{TT}	Termination voltage	—	0.713	0.75	0.788	V
$V_{IH(DC)}$	DC high-level input voltage	—	$V_{REF} + 0.1$	—	—	V
$V_{IL(DC)}$	DC low-level input voltage	—	-0.3	—	$V_{REF} - 0.1$	V
$V_{IH(AC)}$	AC high-level input voltage	—	$V_{REF} + 0.2$	—	—	V
$V_{IL(AC)}$	AC low-level input voltage	—	—	—	$V_{REF} - 0.2$	V
V_{OH}	High-level output voltage	$I_{OH} = 16 \text{ mA (1), (2)}$	$V_{CCIO} - 0.4$	—	—	V

Table 4–23. 1.5-V HSTL Class II Specifications (Part 2 of 2)

Symbol	Parameter	Conditions	Minimum	Typical	Maximum	Unit
V_{OL}	Low-level output voltage	$I_{OL} = -16 \text{ mA}$ (1), (2)	—	—	0.4	V

Notes to Table 4–23:

- (1) This specification is supported across all the programmable drive settings available for this I/O standard as shown in the *I/O Structure and Features* section of the *Description, Architecture, and Features* chapter in volume 1 of the *HardCopy Series Devices Handbook*.
- (2) Drive strength varies based on pin location. Refer to the *Description, Architecture, and Features* chapter in the *HardCopy II Device Family Data Sheet* section in volume 1 of the *HardCopy Series Handbook* for more information.

Table 4–24. 1.5-V Differential HSTL Specifications

Symbol	Parameter	Conditions	Minimum	Typical	Maximum	Unit
V_{CCIO}	I/O supply voltage	—	1.425	1.5	1.575	V
$V_{DIF(DC)}$	DC input differential voltage	—	0.2	—	—	V
$V_{CM(DC)}$	DC common mode input voltage	—	0.68	—	0.9	V
$V_{DIF(AC)}$	AC differential input voltage	—	0.4	—	—	V
$V_{OX(AC)}$	AC differential cross point voltage	—	0.68	—	0.9	V

Table 4–25. 1.8-V HSTL Class I Specifications (Part 1 of 2)

Symbol	Parameter	Conditions	Minimum	Typical	Maximum	Unit
V_{CCIO}	Output-supply voltage	—	1.71	1.8	1.89	V
V_{REF}	Input reference voltage	—	0.85	0.9	0.95	V
V_{TT}	Termination voltage	—	0.85	0.9	0.95	V
$V_{IH(DC)}$	DC high-level input voltage	—	$V_{REF} + 0.1$	—	—	V
$V_{IL(DC)}$	DC low-level input voltage	—	-0.3	—	$V_{REF} - 0.1$	V
$V_{IH(AC)}$	AC high-level input	—	$V_{REF} + 0.2$	—	—	V
$V_{IL(AC)}$	AC low-level input voltage	—	—	—	$V_{REF} - 0.2$	V
V_{OH}	High-level output voltage	$I_{OH} = 8 \text{ mA}$ (1), (2)	$V_{CCIO} - 0.4$	—	—	V

Table 4–25. 1.8-V HSTL Class I Specifications (Part 2 of 2)

Symbol	Parameter	Conditions	Minimum	Typical	Maximum	Unit
V _{OL}	Low-level output voltage	I _{OL} = -8 mA (1), (2)	—	—	0.4	V

Notes to Table 4–25:

- (1) This specification is supported across all the programmable drive settings available for this I/O standard as shown in the *I/O Structure and Features* section located in the *Description, Architecture, and Features* chapter of the *HardCopy Series Devices Handbook*.
- (2) Drive strength varies based on pin location. Refer to the *Description, Architecture, and Features* chapter in the *HardCopy II Device Family Data Sheet* section in volume 1 of the *HardCopy Series Handbook* for more information.

Table 4–26. 1.8-V HSTL Class II Specifications

Symbol	Parameter	Conditions	Minimum	Typical	Maximum	Unit
V _{CCIO}	Output-supply voltage	—	1.71	1.8	1.89	V
V _{REF}	Input reference voltage	—	0.85	0.9	0.95	V
V _{TT}	Termination voltage	—	0.85	0.9	0.95	V
V _{IH (DC)}	DC high-level input voltage	—	V _{REF} + 0.1	—	—	V
V _{IL (DC)}	DC low-level input voltage	—	-0.3	—	V _{REF} - 0.1	V
V _{IH (AC)}	AC high-level input voltage	—	V _{REF} + 0.2	—	—	V
V _{IL (AC)}	AC low-level input voltage	—	—	—	V _{REF} - 0.2	V
V _{OH}	High-level output voltage	I _{OH} = 16 mA (1), (2)	V _{CCIO} - 0.4	—	—	V
V _{OL}	Low-level output voltage	I _{OL} = -16 mA (1), (2)	—	—	0.4	V

Notes to Table 4–26:

- (1) This specification is supported across all the programmable drive settings available for this I/O standard as shown in the *I/O Structure and Features* section located in the *Description, Architecture, and Features* chapter in volume 1 of the *HardCopy Series Devices Handbook*.
- (2) Drive strength varies based on pin location. Refer to the *Description, Architecture, and Features* chapter in the *HardCopy II Device Family Data Sheet* section in volume 1 of the *HardCopy Series Handbook* for more information.

Table 4–27. 1.8-V Differential HSTL Specifications (Part 1 of 2)

Symbol	Parameter	Conditions	Minimum	Typical	Maximum	Unit
V _{CCIO}	I/O supply voltage	—	1.71	1.8	1.89	V
V _{DIF (DC)}	DC input differential voltage	—	0.2	—	V _{CCIO} + 0.6 V	V
V _{CM (DC)}	DC common mode input voltage	—	0.78	—	1.12	V

Table 4–27. 1.8-V Differential HSTL Specifications (Part 2 of 2)

Symbol	Parameter	Conditions	Minimum	Typical	Maximum	Unit
$V_{DIF(AC)}$	AC differential input voltage	—	0.4	—	$V_{CCIO} + 0.6\text{ V}$	V
$V_{OX(AC)}$	AC differential cross point voltage	—	0.68	—	0.9	V

Bus Hold Specifications

Table 4–28 shows the HardCopy II device family’s bus hold specifications.

Table 4–28. Bus Hold Parameters

Parameter	Conditions	V_{CCIO} Level								Unit
		1.5 V		1.8 V		2.5 V		3.3 V		
		Min	Max	Min	Max	Min	Max	Min	Max	
Low sustaining current	$V_{IN} > V_{IL}$ (maximum)	25	—	30	—	50	—	70	—	μA
High sustaining current	$V_{IN} < V_{IH}$ (minimum)	-25	—	-30	—	-50	—	-70	—	μA
Low overdrive current	$0\text{ V} < V_{IN} < V_{CCIO}$	—	160	—	200	—	300	—	500	μA
High overdrive current	$0\text{ V} < V_{IN} < V_{CCIO}$	—	-160	—	-200	—	-300	—	-500	μA
Bus-hold trip point	—	0.50	1.00	0.68	1.07	0.70	1.70	0.80	2.00	V

On-Chip Termination Specifications

Table 4–29 defines the specification for internal termination specification when using series or differential on-chip termination for HC210W devices only.

Table 4–29. Series On-Chip Termination Specification for I/O Banks Supporting Memory Interface IOEs for HC210W Notes (1), (2), (3)

Symbol	Description	Conditions	Resistance Tolerance		
			Commercial Max	Industrial Max	Unit
25 Ω R_S 3.3/2.5	Internal series termination with calibration (25- Ω setting)	$V_{CCIO} = 3.3/2.5$ V	± 10	± 15	%
	Internal series termination without calibration (25- Ω setting)	$V_{CCIO} = 3.3/2.5$ V	± 30	± 30	%
50 Ω R_S 3.3/2.5	Internal series termination with calibration (50- Ω setting)	$V_{CCIO} = 3.3/2.5$ V	± 10	± 15	%
	Internal series termination without calibration (50- Ω setting)	$V_{CCIO} = 3.3/2.5$ V	± 30	± 30	%
25 Ω R_S 1.8	Internal series termination with calibration (25- Ω setting)	$V_{CCIO} = 1.8$ V	± 10	± 15	%
	Internal series termination without calibration (25- Ω setting)	$V_{CCIO} = 1.8$ V	± 30	± 30	%
50 Ω R_S 1.8	Internal series termination with calibration (50- Ω setting)	$V_{CCIO} = 1.8$ V	± 10	± 15	%
	Internal series termination without calibration (50- Ω setting)	$V_{CCIO} = 1.8$ V	± 30	± 30	%
50 Ω R_S 1.5	Internal series termination with calibration (50- Ω setting)	$V_{CCIO} = 1.5$ V	± 13	± 15	%
	Internal series termination without calibration (50- Ω setting)	$V_{CCIO} = 1.5$ V	± 36	± 36	%

Notes to Table 4–29:

- (1) For information on which I/O banks support memory interface IOEs, refer to the *Description, Architecture, and Features* chapter in the *HardCopy II Device Family Data Sheet* section in volume 1 of the *HardCopy Series Handbook*.
- (2) The resistance tolerances for calibrated SOCT and POCT are at the time of initial of calibration. If the temperature or voltage changes over time, the tolerance may also change.
- (3) This table applies only to the HC210W device.

Tables 4–30 and 4–31 define the specification for internal termination specification when using series or differential on-chip termination.

Table 4–30. Series On-Chip Termination Specification for I/O Banks Supporting Memory Interface IOEs
Notes (1), (2), (3)

Symbol	Description	Conditions	Resistance Tolerance		
			Commercial Max	Industrial Max	Unit
25 Ω R_S 3.3/2.5	Internal series termination with calibration (25- Ω setting)	$V_{CCIO} = 3.3/2.5$ V	± 5	± 10	%
	Internal series termination without calibration (25- Ω setting)	$V_{CCIO} = 3.3/2.5$ V	± 30	± 30	%
50 Ω R_S 3.3/2.5	Internal series termination with calibration (50- Ω setting)	$V_{CCIO} = 3.3/2.5$ V	± 5	± 10	%
	Internal series termination without calibration (50- Ω setting)	$V_{CCIO} = 3.3/2.5$ V	± 30	± 30	%
25 Ω R_S 1.8	Internal series termination with calibration (25- Ω setting)	$V_{CCIO} = 1.8$ V	± 5	± 10	%
	Internal series termination without calibration (25- Ω setting)	$V_{CCIO} = 1.8$ V	± 30	± 30	%
50 Ω R_S 1.8	Internal series termination with calibration (50- Ω setting)	$V_{CCIO} = 1.8$ V	± 5	± 10	%
	Internal series termination without calibration (50- Ω setting)	$V_{CCIO} = 1.8$ V	± 30	± 30	%
50 Ω R_S 1.5	Internal series termination with calibration (50- Ω setting)	$V_{CCIO} = 1.5$ V	± 8	± 10	%
	Internal series termination without calibration (50- Ω setting)	$V_{CCIO} = 1.5$ V	± 36	± 36	%

Notes to Table 4–30:

- (1) For information on which I/O banks support memory interface IOEs, refer to the *Description, Architecture, and Features* chapter in the *HardCopy II Device Family Data Sheet* section in volume 1 of the *HardCopy Series Handbook*.
- (2) The resistance tolerances for calibrated SOCT and POCT are at the time of initial calibration. If the temperature or voltage changes over time, the tolerance may also change.
- (3) This table applies only to HC210, HC220, HC230 and HC240 devices.

Table 4–31. Series and Differential On-Chip Termination Specification for I/O Banks Supporting High-Speed and General Purpose IOEs Notes (1), (3), (4)

Symbol	Description	Conditions	Resistance Tolerance		
			Commercial Max	Industrial Max	Unit
25 Ω R_S 3.3/2.5	Internal series termination without calibration (25- Ω setting)	$V_{CCIO} = 3.3/2.5$ V	± 30	± 30	%
50 Ω R_S 3.3/2.5/1.8	Internal series termination without calibration (50- Ω setting)	$V_{CCIO} = 3.3/2.5/1.8$ V	± 30	± 30	%
50 Ω R_S 1.5	Internal series termination without calibration (50- Ω setting)	$V_{CCIO} = 1.5$ V	± 36	± 36	%
R_D (2)	Internal differential termination for LVDS or HyperTransport technology	—	± 20	± 25	%

Notes to Table 4–31:

- (1) For information on which I/O banks support high-speed IOEs, refer to the *Description, Architecture, and Features* chapter in the *HardCopy II Device Family Data Sheet* section in volume 1 of the *HardCopy Series Handbook*.
- (2) R_D is only supported on high-speed IOEs.
- (3) The resistance tolerances for calibrated SOCT and POCT are at the time of initial calibration. If the temperature or voltage changes over time, the tolerance may also change.
- (4) This table applies only to HC210, HC220, HC230, and HC240 devices.

Pin Capacitance Table 4–32 shows the HardCopy II device family's pin capacitance.**Table 4–32. HardCopy II Device Capacitance** Note (1) (Part 1 of 2)

Symbol	Parameter	HC210W Typical	HC210, HC220, HC230, HC240 Typical	Unit
C_{GPIO}	Input capacitance on I/O pins in I/O banks supporting general-purpose IOEs.	5.7	5.0	pF
C_{MIIIO}	Input capacitance on I/O pins in I/O banks supporting memory interface IOEs.	5.7	5.0	pF
C_{HSIO}	Input capacitance on I/O pins in I/O banks supporting high-speed IOEs.	7.2	6.1	pF
C_{CLKTB}	Input capacitance on top/bottom clock input pins CLK[4..7] and CLK[12..15].	6.0	6.0	pF

Table 4–32. HardCopy II Device Capacitance *Note (1) (Part 2 of 2)*

Symbol	Parameter	HC210W Typical	HC210, HC220, HC230, HC240 Typical	Unit
C _{CLKLR}	Input capacitance on left/right clock inputs CLK0, CLK2, CLK8, CLK10.	4.3	6.1	pF
C _{CLKLR+}	Input capacitance on left/right clock inputs CLK1, CLK3, CLK9, and CLK11.	4.2	3.3	pF
C _{OUTFB}	Input capacitance on dual-purpose clock output/feedback pins in PLL banks 9, 10, 11, and 12.	6.9	6.7	pF

Note to Table 4–32:

- (1) Capacitance is sample-tested only. Capacitance is measured using time-domain reflections (TDR). Measurement accuracy is within ± 0.5 pF.

Maximum Input Clock Rates

Tables 4–33 and 4–34 show the maximum input clocking rates of HardCopy II I/Os.

Table 4–33. HardCopy II Maximum Input Clock Rates of HC210, HC220, HC230 and HC240 Devices (Part 1 of 2)

I/O Standard	Memory Interface IOEs	High Speed IOEs	General Purpose IOEs	CLK [0..3, 8..11]	CLK [4..7, 12..15]	FPLL_CLK	PLL_FB	Unit
LVTTTL	500	500	500	500	500	500	500	MHz
2.5 V	500	500	500	500	500	500	500	MHz
1.8 V	500	500	500	500	500	500	500	MHz
1.5 V	500	500	500	500	500	500	500	MHz
LVC MOS	500	500	500	500	500	500	500	MHz
SSTL2 class I	500	—	—	—	500	—	500	MHz
SSTL2 class II	500	—	—	—	500	—	500	MHz
SSTL18 class I	500	—	—	—	500	—	500	MHz
SSTL18 class II	500	—	—	—	500	—	500	MHz
1.5 V HSTL class I	500	—	—	—	500	—	500	MHz
1.5 V HSTL class II	500	—	—	—	500	—	500	MHz
1.8 V HSTL class I	500	—	—	—	500	—	500	MHz
1.8 V HSTL class II	500	—	—	—	500	—	500	MHz
PCI (1)	500	—	500	—	500	—	500	MHz

Table 4–33. HardCopy II Maximum Input Clock Rates of HC210, HC220, HC230 and HC240 Devices (Part 2 of 2)

I/O Standard	Memory Interface IOEs	High Speed IOEs	General Purpose IOEs	CLK [0..3, 8..11]	CLK [4..7, 12..15]	FPLL_CLK	PLL_FB	Unit
PCI-X (1)	500	—	500	—	500	—	500	MHz
Differential SSTL2 class I (2), (3)	500	—	—	—	500	—	500	MHz
Differential SSTL2 class II (2), (3)	500	—	—	—	500	—	500	MHz
Differential SSTL18 class I (2), (3)	500	—	—	—	500	—	500	MHz
Differential SSTL18 class II (2), (3)	500	—	—	—	500	—	500	MHz
1.8-V Differential HSTL class I (2), (3)	500	—	—	—	500	—	500	MHz
1.8-V Differential HSTL class II (2), (3)	500	—	—	—	500	—	500	MHz
1.5-V Differential HSTL class I (2), (3)	500	—	—	—	500	—	500	MHz
1.5-V Differential HSTL class II (2), (3)	500	—	—	—	500	—	500	MHz
LVDS	—	520	—	717	450	717	450	MHz
LVPECL	—	—	—	—	450	—	450	MHz
HyperTransport	—	520	—	717	—	717	—	MHz

Notes to Table 4–33:

- (1) The PCI clamping diode is only supported on the top and bottom I/O pins.
- (2) This I/O standard is only supported on the DQS, CLK, and PLL_FB input pins.
- (3) For HC210 and HC220, differential HSTL/SSTL input is supported on top/bottom PLL_FB, the top clock pins and DQS pins located on the top I/Os.

Table 4–34. HardCopy II Maximum Input Clock Rates of HC210W Devices *Note (3) (Part 1 of 2)*

I/O Standard	Memory Interface IOEs	High Speed IOEs	General Purpose IOEs	CLK [0..3, 8..11]	CLK [4..7, 12..15]	FPLL_C LK	PLL_FB	Unit
LVTTTL	350	350	350	350	350	350	350	MHz
2.5-V LVTTTL/LVCMOS	350	350	350	350	350	350	350	MHz
1.8-V LVTTTL/LVCMOS	350	350	350	350	350	350	350	MHz
1.5-V LVTTTL/LVCMOS	270	270	270	270	270	270	270	MHz
LVCMOS	350	350	350	350	350	350	350	MHz
SSTL2 class I	350	—	—	—	350	—	350	MHz
SSTL2 class II	350	—	—	—	350	—	350	MHz
SSTL18 class I	350	—	—	—	350	—	350	MHz
SSTL18 class II	350	—	—	—	350	—	350	MHz
1.5-V HSTL class I	350	—	—	—	350	—	350	MHz
1.5-V HSTL class II	350	—	—	—	350	—	350	MHz
1.8-V HSTL class I	350	—	—	—	350	—	350	MHz
1.8-V HSTL class II	350	—	—	—	350	—	350	MHz
PCI (1)	315	—	315	—	315	—	315	MHz
PCI-X (1)	315	—	315	—	315	—	315	MHz
Differential SSTL2 class I (2)	—	—	—	—	350	—	350	MHz
Differential SSTL2 class II (2)	—	—	—	—	350	—	350	MHz
Differential SSTL18 class I (2)	—	—	—	—	350	—	350	MHz
Differential SSTL18 class II (2)	—	—	—	—	350	—	350	MHz
1.8-V differential HSTL class I (2)	—	—	—	—	350	—	350	MHz
1.8-V differential HSTL class II (2)	—	—	—	—	350	—	350	MHz
1.5-V differential HSTL class I (2)	—	—	—	—	350	—	350	MHz
1.5-V differential HSTL class II (2)	—	—	—	—	350	—	350	MHz
LVDS	—	320	—	320	320	320	320	MHz
LVPECL	—	—	—	—	320	—	320	MHz

Table 4–34. HardCopy II Maximum Input Clock Rates of HC210W Devices *Note (3) (Part 2 of 2)*

I/O Standard	Memory Interface IOEs	High Speed IOEs	General Purpose IOEs	CLK [0..3, 8..11]	CLK [4..7, 12..15]	FPLL_C LK	PLL_FB	Unit
HyperTransport	—	320	—	320	—	320	—	MHz

Notes to Table 4–34:

- (1) The PCI clamping diode is only supported on the top and bottom I/O pins.
- (2) For HC210W, differential HSTL/SSTL input is supported on the top clock pins, the DQS pins on the top I/O banks and top/bottom PLL_FB input pins.
- (3) These numbers are preliminary and pending further silicon characterization.

Maximum Output Clock Rates

Tables 4–35 and 4–36 show the maximum output toggle rates of HardCopy II I/O's for all available drive strengths.

Table 4–35. HardCopy II Maximum Output Clock Rate of HC210, HC220, HC230 and HC240 Devices *Note (1) (Part 1 of 5)*

I/O Standard	Drive Strength	Memory Interface IOEs	High Speed IOEs	General Purpose IOEs		CLK [0, 2, 8, 10] (2)	CLK [4..7, 12..15]	PLL_OUT	Unit
				Bottom Column	Right Row				
3.3-V LVTTTL	4 mA	225	225	225	225	225	225	225	MHz
	8 mA	355	355	355	355	355	355	355	MHz
	12 mA	475	475	475	475	475	475	475	MHz
	16 mA	594	—	—	—	—	594	594	MHz
	20 mA	700	—	—	—	—	700	700	MHz
	24 mA (3)	794	—	—	—	—	794	794	MHz
3.3-V LVCMOS	4 mA	250	250	250	250	250	250	250	MHz
	8 mA	480	480	480	480	480	480	480	MHz
	12 mA	710	—	—	—	—	710	710	MHz
	16 mA	925	—	—	—	—	925	925	MHz
	20 mA	985	—	—	—	—	985	985	MHz
	24 mA (3)	1040	—	—	—	—	1040	1040	MHz

Table 4–35. HardCopy II Maximum Output Clock Rate of HC210, HC220, HC230 and HC240 Devices
Note (1) (Part 2 of 5)

I/O Standard	Drive Strength	Memory Interface IOEs	High Speed IOEs	General Purpose IOEs		CLK [0, 2, 8, 10] (2)	CLK [4..7, 12..15]	PLL_OUT	Unit
				Bottom Column	Right Row				
2.5-V LVTTTL / LVCMOS	4 mA	194	194	194	194	194	194	194	MHz
	8 mA	380	380	380	380	380	380	380	MHz
	12 mA	575	575	575	575	575	575	575	MHz
	16 mA (3)	845	—	—	—	—	845	845	MHz
1.8-V LVTTTL / LVCMOS	2 mA	109	109	109	109	109	109	109	MHz
	4 mA	250	250	250	250	250	250	250	MHz
	6 mA	390	390	390	390	390	390	390	MHz
	8 mA	570	570	570	570	570	570	570	MHz
	10 mA	805	—	—	—	—	805	805	MHz
	12 mA (3)	1040	—	—	—	—	1040	1040	MHz
1.5-V LVTTTL / LVCMOS	2 mA	200	200	200	200	200	200	200	MHz
	4 mA	370	370	370	370	370	370	370	MHz
	6 mA	430	—	—	—	—	430	430	MHz
	8 mA (3)	495	—	—	—	—	495	495	MHz
SSTL2 class I	8 mA	300	—	—	—	—	300	300	MHz
	12 mA (3)	400	—	—	—	—	400	400	MHz
SSTL2 class II	16 mA	350	—	—	—	—	350	350	MHz
	20 mA	350	—	—	—	—	350	350	MHz
	24 mA (3)	400	—	—	—	—	400	400	MHz
SSTL18 class I	4 mA	150	—	—	—	—	150	150	MHz
	6 mA	250	—	—	—	—	250	250	MHz
	8 mA	300	—	—	—	—	300	300	MHz
	10 mA	400	—	—	—	—	400	400	MHz
	12 mA (3)	550	—	—	—	—	550	550	MHz
SSTL18 class II	8 mA	200	—	—	—	—	200	200	MHz
	16 mA	350	—	—	—	—	350	350	MHz
	18 mA	400	—	—	—	—	400	400	MHz
	20 mA (3)	500	—	—	—	—	500	500	MHz

Table 4–35. HardCopy II Maximum Output Clock Rate of HC210, HC220, HC230 and HC240 Devices
Note (1) (Part 3 of 5)

I/O Standard	Drive Strength	Memory Interface IOEs	High Speed IOEs	General Purpose IOEs		CLK [0, 2, 8, 10] (2)	CLK [4..7, 12..15]	PLL_OUT	Unit
				Bottom Column	Right Row				
1.8-V HSTL class I	4 mA	300	—	—	—	—	300	300	MHz
	6 mA	450	—	—	—	—	450	450	MHz
	8 mA	600	—	—	—	—	600	600	MHz
	10 mA	650	—	—	—	—	650	650	MHz
	12 mA (3)	700	—	—	—	—	700	700	MHz
1.8-V HSTL class II	16 mA	500	—	—	—	—	500	500	MHz
	18 mA	500	—	—	—	—	500	500	MHz
	20 mA (3)	550	—	—	—	—	550	550	MHz
1.5-V HSTL class I	4 mA	300	—	—	—	—	300	300	MHz
	6 mA	500	—	—	—	—	500	500	MHz
	8 mA	650	—	—	—	—	650	650	MHz
	10 mA	700	—	—	—	—	700	700	MHz
	12 mA (3)	700	—	—	—	—	700	700	MHz
1.5-V HSTL class II	16 mA	600	—	—	—	—	600	600	MHz
	18 mA	600	—	—	—	—	600	600	MHz
	20 mA (3)	650	—	—	—	—	650	650	MHz
PCI (4)	—	790	—	790	—	—	790	790	MHz
PCI-X (4)	—	790	—	790	—	—	790	790	MHz
LVDS	—	—	717	—	—	—	—	400	MHz
HyperTransport	—	—	717	—	—	—	—	—	MHz
LVPECL	—	—	—	—	—	—	—	400	MHz
Differential SSTL2 class I (5)	8 mA	300	—	—	—	—	300	300	MHz
	12 mA (3)	400	—	—	—	—	400	400	MHz
Differential SSTL2 class II (5)	16 mA	350	—	—	—	—	350	350	MHz
	20 mA (3)	350	—	—	—	—	350	350	MHz
	24 mA (3)	400	—	—	—	—	400	400	MHz

Table 4–35. HardCopy II Maximum Output Clock Rate of HC210, HC220, HC230 and HC240 Devices
Note (1) (Part 4 of 5)

I/O Standard	Drive Strength	Memory Interface IOEs	High Speed IOEs	General Purpose IOEs		CLK [0, 2, 8, 10] (2)	CLK [4..7, 12..15]	PLL_OUT	Unit
				Bottom Column	Right Row				
Differential SSTL18 class I (5)	4 mA	150	—	—	—	—	150	150	MHz
	6 mA	250	—	—	—	—	250	250	MHz
	8 mA	300	—	—	—	—	300	300	MHz
	10 mA	400	—	—	—	—	400	400	MHz
	12 mA (3)	550	—	—	—	—	550	550	MHz
Differential SSTL18 class II (5)	8 mA	200	—	—	—	—	200	200	MHz
	16 mA	350	—	—	—	—	350	350	MHz
	18 mA	400	—	—	—	—	400	400	MHz
	20 mA (3)	500	—	—	—	—	500	500	MHz
1.8-V differential HSTL class I (5)	4 mA	300	—	—	—	—	300	300	MHz
	6 mA	450	—	—	—	—	450	450	MHz
	8 mA	600	—	—	—	—	600	600	MHz
	10 mA	650	—	—	—	—	650	650	MHz
	12 mA (3)	700	—	—	—	—	700	700	MHz
1.8-V differential HSTL class II (5)	16 mA	500	—	—	—	—	500	500	MHz
	18 mA	500	—	—	—	—	500	500	MHz
	20 mA (3)	550	—	—	—	—	550	550	MHz
1.5-V differential HSTL class I (5)	4 mA	300	—	—	—	—	300	300	MHz
	6 mA	500	—	—	—	—	500	500	MHz
	8 mA	650	—	—	—	—	650	650	MHz
	10 mA	700	—	—	—	—	700	700	MHz
	12 mA (3)	700	—	—	—	—	700	700	MHz

Table 4–35. HardCopy II Maximum Output Clock Rate of HC210, HC220, HC230 and HC240 Devices
Note (1) (Part 5 of 5)

I/O Standard	Drive Strength	Memory Interface IOEs	High Speed IOEs	General Purpose IOEs		CLK [0, 2, 8, 10] (2)	CLK [4..7, 12..15]	PLL_OUT	Unit
				Bottom Column	Right Row				
1.5-V differential HSTL class II (5)	16 mA	600	—	—	—	—	600	600	MHz
	18 mA	600	—	—	—	—	600	600	MHz
	20 mA (3)	650	—	—	—	—	650	650	MHz

Notes to Table 4–35:

- (1) The toggle rate applies to 0 pF output load for all I/O standards except for LVDS and HyperTransport technology on row I/O pins. For LVDS and HyperTransport technology on row I/O pins, the toggle rates apply to load from 0 to 5 pF.
- (2) CLK [1, 3, 9, 11] and FPLL_CLK are dedicated input clocks, and are excluded from this table.
- (3) This is the default setting in the Quartus® II software if supported by the pin location.
- (4) The PCI clamping diode is only supported on the top and bottom I/O pins.
- (5) Like Stratix II devices, differential HSTL and SSTL is supported only on the column CLK, PLL_OUT and memory interface DQS IOE pins. For HC210 and HC220, only the top column clock pins support Differential HSTL and SSTL.

Table 4–36. HardCopy II Maximum Output Clock Rate for HC210W Devices *Notes (1), (6) (Part 1 of 4)*

I/O Standard	Drive Strength	Memory Interface IOEs	High Speed IOEs	General Purpose IOEs		CLK [0, 2, 8, 10] (2)	CLK [4..7, 12..15]	PLL_OUT	Unit
				Bottom Column	Right Row				
3.3-V LVTTTL	4 mA	100	100	100	100	100	100	100	MHz
	8 mA	170	170	170	170	170	170	170	MHz
	12 mA	230	230	230	230	230	230	230	MHz
	16 mA	240	—	—	—	—	240	240	MHz
	20 mA	280	—	—	—	—	280	280	MHz
	24 mA (3)	300	—	—	—	—	300	300	MHz
3.3-V LVCMOS	4 mA	175	175	175	175	175	175	175	MHz
	8 mA	230	230	230	230	230	230	230	MHz
	12 mA	260	—	—	—	—	260	260	MHz
	16 mA	270	—	—	—	—	270	270	MHz
	20 mA	290	—	—	—	—	290	290	MHz
	24 mA (3)	310	—	—	—	—	310	310	MHz

Table 4–36. HardCopy II Maximum Output Clock Rate for HC210W Devices Notes (1), (6) (Part 2 of 4)

I/O Standard	Drive Strength	Memory Interface IOEs	High Speed IOEs	General Purpose IOEs		CLK [0, 2, 8, 10] (2)	CLK [4..7, 12..15]	PLL_OUT	Unit
				Bottom Column	Right Row				
2.5-V LVTTTL / LVCMOS	4 mA	136	136	136	136	136	136	136	MHz
	8 mA	230	230	230	230	230	230	230	MHz
	12 mA	370	370	370	370	370	370	370	MHz
	16 mA (3)	405	—	—	—	—	405	405	MHz
1.8-V LVTTTL / LVCMOS	2 mA	77	77	77	77	77	77	77	MHz
	4 mA	150	150	150	150	150	150	150	MHz
	6 mA	180	180	180	180	180	180	180	MHz
	8 mA	200	200	200	200	200	200	200	MHz
	10 mA	250	—	—	—	—	250	250	MHz
	12 mA (3)	290	—	—	—	—	290	290	MHz
1.5-V LVTTTL / LVCMOS	2 mA	60	60	60	60	60	60	60	MHz
	4 mA	110	110	110	110	110	110	110	MHz
	6 mA	150	—	—	—	—	150	150	MHz
	8 mA (3)	190	—	—	—	—	190	190	MHz
SSTL2 class I	8 mA	210	—	—	—	—	210	210	MHz
	12 mA (3)	280	—	—	—	—	280	280	MHz
SSTL2 class II	16 mA	245	—	—	—	—	245	245	MHz
	20 mA	245	—	—	—	—	245	245	MHz
	24 mA (3)	280	—	—	—	—	280	280	MHz
SSTL18 class I	4 mA	105	—	—	—	—	105	105	MHz
	6 mA	175	—	—	—	—	175	175	MHz
	8 mA	210	—	—	—	—	210	210	MHz
	10 mA	220	—	—	—	—	220	220	MHz
	12 mA (3)	230	—	—	—	—	230	230	MHz
SSTL18 class II	8 mA	140	—	—	—	—	140	140	MHz
	16 mA	220	—	—	—	—	220	220	MHz
	18 mA	220	—	—	—	—	220	220	MHz
	20 mA (3)	350	—	—	—	—	350	350	MHz

Table 4–36. HardCopy II Maximum Output Clock Rate for HC210W Devices Notes (1), (6) (Part 3 of 4)

I/O Standard	Drive Strength	Memory Interface IOEs	High Speed IOEs	General Purpose IOEs		CLK [0, 2, 8, 10] (2)	CLK [4..7, 12..15]	PLL_OUT	Unit
				Bottom Column	Right Row				
1.8-V HSTL class I	4 mA	210	—	—	—	—	210	210	MHz
	6 mA	210	—	—	—	—	210	210	MHz
	8 mA	220	—	—	—	—	220	220	MHz
	10 mA	250	—	—	—	—	250	250	MHz
	12 mA (3)	270	—	—	—	—	270	270	MHz
1.8-V HSTL class II	16 mA	190	—	—	—	—	190	190	MHz
	18 mA	200	—	—	—	—	200	200	MHz
	20 mA (3)	210	—	—	—	—	210	210	MHz
1.5-V HSTL class I	4 mA	150	—	—	—	—	150	150	MHz
	6 mA	160	—	—	—	—	160	160	MHz
	8 mA	170	—	—	—	—	170	170	MHz
	10 mA	180	—	—	—	—	180	180	MHz
	12 mA (3)	190	—	—	—	—	190	190	MHz
1.5-V HSTL class II	16 mA	170	—	—	—	—	170	170	MHz
	18 mA	170	—	—	—	—	170	170	MHz
	20 mA (3)	170	—	—	—	—	170	170	MHz
PCI (4)	—	315	—	315	—	—	315	315	MHz
PCI-X (4)	—	315	—	315	—	—	315	315	MHz
LVDS	—	—	320	—	—	—	—	280	MHz
HyperTransport	—	—	320	—	—	—	—	—	MHz
LVPECL	—	—	—	—	—	—	—	280	MHz
Differential SSTL2 class I (5)	8 mA	210	—	—	—	—	210	210	MHz
	12 mA (3)	280	—	—	—	—	280	280	MHz
Differential SSTL2 class II (5)	16 mA	245	—	—	—	—	245	245	MHz
	20 mA	245	—	—	—	—	245	245	MHz
	24 mA (3)	280	—	—	—	—	280	280	MHz
Differential SSTL18 class I (5)	4 mA	105	—	—	—	—	105	105	MHz
	6 mA	175	—	—	—	—	175	175	MHz
	8 mA	210	—	—	—	—	210	210	MHz
	10 mA	220	—	—	—	—	220	220	MHz
	12 mA (3)	230	—	—	—	—	230	230	MHz

Table 4–36. HardCopy II Maximum Output Clock Rate for HC210W Devices Notes (1), (6) (Part 4 of 4)

I/O Standard	Drive Strength	Memory Interface IOEs	High Speed IOEs	General Purpose IOEs		CLK [0, 2, 8, 10] (2)	CLK [4..7, 12..15]	PLL_OUT	Unit
				Bottom Column	Right Row				
Differential SSTL18 class II (5)	8 mA	140	—	—	—	—	140	140	MHz
	16 mA	220	—	—	—	—	220	220	MHz
	18 mA	220	—	—	—	—	220	220	MHz
	20 mA (3)	220	—	—	—	—	220	220	MHz
1.8-V differential HSTL class I (5)	4 mA	210	—	—	—	—	210	210	MHz
	6 mA	210	—	—	—	—	210	210	MHz
	8 mA	220	—	—	—	—	220	220	MHz
	10 mA	250	—	—	—	—	250	250	MHz
	12 mA (3)	270	—	—	—	—	270	270	MHz
1.8-V differential HSTL class II (5)	16 mA	190	—	—	—	—	190	190	MHz
	18 mA	200	—	—	—	—	200	200	MHz
	20 mA (3)	210	—	—	—	—	210	210	MHz
1.5-V differential HSTL class I (5)	4 mA	150	—	—	—	—	150	150	MHz
	6 mA	160	—	—	—	—	160	160	MHz
	8 mA	170	—	—	—	—	170	170	MHz
	10 mA	180	—	—	—	—	180	180	MHz
	12 mA (3)	190	—	—	—	—	190	190	MHz
1.5-V differential HSTL class II (5)	16 mA	170	—	—	—	—	170	170	MHz
	18 mA	170	—	—	—	—	170	170	MHz
	20 mA (3)	170	—	—	—	—	170	170	MHz

Notes to Table 4–36:

- (1) The toggle rate applies to 0 pF output load for all I/O standards except for LVDS and HyperTransport technology on row I/O pins. For LVDS and HyperTransport technology on row I/O pins, the toggle rates apply to load from 0 to 5 pF.
- (2) CLK [1, 3, 9, 11] and FPLL_CLK are dedicated input clocks, and excluded from this table.
- (3) This is the default setting in the Quartus II software if supported by the pin location.
- (4) The PCI clamping diode is only supported on the top and bottom I/O pins.
- (5) Like Stratix II devices, differential HSTL and SSTL is supported only on the column CLK, PLL_OUT and memory interface DQS IOE pins. For HC210 and HC220, only the top column clock pins support Differential HSTL and SSTL.
- (6) These numbers are preliminary and pending further silicon characterization.

Tables 4–37 and 4–38 show the maximum output toggle rates of HardCopy II I/Os using OCT.

Table 4–37. HardCopy II Maximum Output Clock Rate for HC210, HC220, HC230 and HC240 Devices (OCT)
Note (1) (Part 1 of 2)

I/O Standard	Drive Strength	Memory Interface IOEs	High Speed IOEs	General Purpose IOEs		CLK [0, 2, 8, 10] (2)	CLK [4..7, 12..15]	PLL_OUT	Unit
				Bottom Column	Right Row				
3.3-V LVTTTL	OCT 50 Ω	400	400	400	400	400	400	400	MHz
2.5-V LVTTTL	OCT 50 Ω	350	350	350	350	350	350	350	MHz
1.8-V LVTTTL	OCT 50 Ω	550	550	550	550	550	550	550	MHz
3.3-V LVCMOS	OCT 50 Ω	350	350	350	350	350	350	350	MHz
1.5-V LVCMOS	OCT 50 Ω	450	450	450	450	450	450	450	MHz
SSTL-2 Class I	OCT 50 Ω	500	—	—	—	—	500	500	MHz
SSTL-2 Class II	OCT 25 Ω	550	—	—	—	—	550	550	MHz
SSTL-18 Class I	OCT 50 Ω	400	—	—	—	—	400	400	MHz
SSTL-18 Class II	OCT 25 Ω	500	—	—	—	—	500	500	MHz
1.5-V HSTL Class I	OCT 50 Ω	550	—	—	—	—	550	550	MHz
1.8-V HSTL Class I	OCT 50 Ω	600	—	—	—	—	600	600	MHz
1.8-V HSTL Class II	OCT 50 Ω	500	—	—	—	—	500	500	MHz
Differential SSTL-2 Class I (3)	OCT 50 Ω	500	—	—	—	—	500	500	MHz
Differential SSTL-2 Class II (3)	OCT 25 Ω	550	—	—	—	—	550	550	MHz
Differential SSTL-18 Class I (3)	OCT 50 Ω	400	—	—	—	—	400	400	MHz
Differential SSTL-18 Class II (3)	OCT 25 Ω	500	—	—	—	—	500	500	MHz
1.8-V Differential HSTL Class I (3)	OCT 50 Ω	600	—	—	—	—	600	600	MHz
1.8-V Differential HSTL Class II (3)	OCT 25 Ω	500	—	—	—	—	500	500	MHz

**Table 4–37. HardCopy II Maximum Output Clock Rate for HC210, HC220, HC230 and HC240 Devices (OCT)
 Note (1) (Part 2 of 2)**

I/O Standard	Drive Strength	Memory Interface IOEs	High Speed IOEs	General Purpose IOEs		CLK [0, 2, 8, 10] (2)	CLK [4..7, 12..15]	PLL_OUT	Unit
				Bottom Column	Right Row				
1.5-V Differential HSTL Class I (3)	OCT 50 Ω	550	—	—	—	—	550	550	MHz

Notes to Table 4–37:

- (1) The toggle rate applies to 0 pF output load for all I/O standards except for LVDS and HyperTransport technology on row I/O pins. For LVDS and HyperTransport technology on row I/O pins, the toggle rates apply to load from 0 to 5 pF.
- (2) CLK [1, 3, 9, 11] and FPLL_CLK are dedicated input clocks, and excluded from this table.
- (3) Like Stratix II devices, differential HSTL and SSTL is supported only on the column CLK, PLL_OUT and memory interface DQS IOE pins. For HC210 and HC220, only the top column clock pins support Differential HSTL and SSTL.

Table 4–38. HardCopy II Maximum Output Clock Rate for HC210W using OCT Notes (1), (4) (Part 1 of 2)

I/O Standard	Drive Strength	Memory Interface IOEs	High Speed IOEs	General Purpose IOEs		CLK [0, 2, 8, 10] (2)	CLK [4..7, 12..15]	PLL_OUT	Unit
				Bottom Column	Right Row				
3.3-V LVTTTL	OCT 50 Ω	280	280	280	280	280	280	280	MHz
2.5-V LVTTTL	OCT 50 Ω	245	245	245	245	245	245	245	MHz
1.8-V LVTTTL	OCT 50 Ω	290	290	290	290	290	290	290	MHz
3.3-V LVCMOS	OCT 50 Ω	245	245	245	245	245	245	245	MHz
1.5-V LVCMOS	OCT 50 Ω	190	190	190	190	190	190	190	MHz
SSTL-2 Class I	OCT 50 Ω	280	—	—	—	—	280	280	MHz
SSTL-2 Class II	OCT 25 Ω	280	—	—	—	—	280	280	MHz
SSTL-18 Class I	OCT 50 Ω	230	—	—	—	—	230	230	MHz
SSTL-18 Class II	OCT 25 Ω	220	—	—	—	—	220	220	MHz
1.5-V HSTL Class I	OCT 50 Ω	190	—	—	—	—	190	190	MHz
1.8-V HSTL Class I	OCT 50 Ω	270	—	—	—	—	270	270	MHz
1.8-V HSTL Class II	OCT 50 Ω	210	—	—	—	—	210	210	MHz

Table 4–38. HardCopy II Maximum Output Clock Rate for HC210W using OCT Notes (1), (4) (Part 2 of 2)

I/O Standard	Drive Strength	Memory Interface IOEs	High Speed IOEs	General Purpose IOEs		CLK [0, 2, 8, 10] (2)	CLK [4..7, 12..15]	PLL_OUT	Unit
				Bottom Column	Right Row				
Differential SSTL-2 Class I (3)	OCT 50 Ω	280	—	—	—	—	280	280	MHz
Differential SSTL-2 Class II (3)	OCT 25 Ω	280	—	—	—	—	280	280	MHz
Differential SSTL-18 Class I (3)	OCT 50 Ω	230	—	—	—	—	230	230	MHz
Differential SSTL-18 Class II (3)	OCT 25 Ω	220	—	—	—	—	220	220	MHz
1.8-V Differential HSTL Class I (3)	OCT 50 Ω	270	—	—	—	—	270	270	MHz
1.8-V Differential HSTL Class II (3)	OCT 25 Ω	210	—	—	—	—	210	210	MHz
1.5-V Differential HSTL Class I (3)	OCT 50 Ω	190	—	—	—	—	190	190	MHz

Notes to Table 4–38:

- (1) The toggle rate applies to 0 pF output load for all I/O standards except for LVDS and HyperTransport technology on row I/O pins. For LVDS and HyperTransport technology on row I/O pins, the toggle rates apply to load from 0 to 5 pF.
- (2) CLK [1, 3, 9, 11] and FPLL_CLK are dedicated input clocks, and excluded from this table.
- (3) Like Stratix II devices, differential HSTL and SSTL is supported only on the column CLK, PLL_OUT and memory interface DQS IOE pins. For HC210 and HC220, only the top column clock pins support differential HSTL and SSTL.
- (4) These numbers are preliminary and pending further silicon characterization.

HighSpeed I/O Specifications

Table 4–39 provides high-speed timing specifications definitions.

Table 4–39. HighSpeed Timing Specifications and Definitions (Part 1 of 2)

HighSpeed Timing Specifications	Definitions
t_C	Highspeed receiver/transmitter input and output clock period.
f_{HSCLK}	Highspeed receiver/transmitter input and output clock frequency.
J	De-serialization factor (width of parallel data bus).

HighSpeed Timing Specifications	Definitions
W	PLL multiplication factor
t_{RISE}	Low-to-high transmission time.
t_{FALL}	High-to-low transmission time.
Timing unit interval (TUI)	The timing budget allowed for skew, propagation delays, and data sampling window. (TUI = 1/(Receiver Input Clock Frequency × Multiplication Factor) = tC/w).
f_{HSDR}	Maximum/minimum LVDS data transfer rate ($f_{HSDR} = 1/TUI$), non-DPA.
$f_{HSDRDPA}$	Maximum/minimum LVDS data transfer rate ($f_{HSDRDPA} = 1/TUI$), DPA.
Channel-to-channel skew (TCCS)	The timing difference between the fastest and slowest output edges, including tCO variation and clock skew. The clock is included in the TCCS measurement.
Sampling window (SW)	The period of time during which the data must be valid in order to capture it correctly. The setup and hold times determine the ideal strobe position within the sampling window.
Input jitter (peak-to-peak)	Peak-to-peak input jitter on highspeed PLLs.
Output jitter (peak-to-peak)	Peak-to-peak output jitter on highspeed PLLs.
t_{DUTY}	Duty cycle on highspeed transmitter output clock.
t_{LOCK}	Lock time for highspeed transmitter and receiver PLLs.

Table 4–40 shows the high-speed I/O timing specifications for HC210W F484 WireBond devices.

Symbol	Conditions	Min	Typ	Max	Unit
f_{HSCLK} (clock frequency) $f_{HSCLK} = f_{HSDR} / W$	W = 2 to 32 (LVDS, HyperTransport technology) (3)	16	—	320	MHz
	W = 1 (SERDES bypass, LVDS only)	16	—	320	MHz
	W = 1 (SERDES used, LVDS only)	150	—	320	MHz
f_{HSDR} (data rate)	J = 4 to 10 (LVDS, HyperTransport technology)	150	—	640	Mbps
	J = 2 (LVDS, HyperTransport technology)	(4)	—	640	Mbps
	J = 1 t(LVDS only)	(4)	—	320	Mbps
$f_{HSDRDPA}$ (DPA data rate)	J = 4 to 10 (LVDS, HyperTransport technology)	150	—	640	Mbps
TCCS	All differential standards	—	—	240	ps
SW	All differential standards	400	—	—	ps
Output jitter	—	—	—	(5)	ps

Table 4–40. HardCopy II High-Speed I/O Specifications for HC210W Device *Notes (1), (2) (Part 2 of 2)*

Symbol	Conditions			Min	Typ	Max	Unit
Output t_{RISE}	All differential I/O standards			—	—	(5)	ps
Output t_{FALL}	All differential I/O standards			—	—	(5)	ps
t_{DUTY}	—	—	—	45	50	55	%
DPA run length	—	—	—	—	—	6,400	UI
DPA jitter tolerance (peak-to-peak)	—	—	—	(5)	—	—	UI
DPA lock time	Standard	Training Pattern	Transition Density	—	—	—	Number of repetitions
	—	—	—	—	—	—	
	SPI4	0000000000 1111111111	10%	(5)	—	—	
	Parallel Rapid I/O	10010000	25%	(5)	—	—	
	—	10010000	50%	(5)	—	—	
	Miscellaneous	10101010	100%	(5)	—	—	
—	10101010	—	(5)	—	—		

Notes to Table 4–40:

- (1) These numbers are preliminary and pending further silicon characterization.
- (2) When J = 4 to 10, the SERDES block is used.
When J = 1 or 2, the SERDES block is bypassed.
- (3) The input clock frequency and the W factor must satisfy the following fast PLL VCO specification: $150 \leq \text{input clock frequency} \times W \leq 640$.
- (4) The minimum specification is dependent on the clock source (fast PLL, enhanced PLL, clock pin, and so on) and the clock routing resource (global, regional, or local) used. The I/O differential buffer and input register do not have a minimum toggle rate.
- (5) Contact the Altera Applications Group for more information.

Table 4–41 shows the high-speed I/O timing specifications for HC210, HC220, HC230 and HC240 HardCopy II devices.

Table 4–41. HardCopy II High-Speed I/O Specifications for HC210, HC220, HC230 and HC240 Devices *Note (1) (Part 1 of 2)*

Symbol	Conditions	Min	Typ	Max	Unit
f_{HSCLK} (clock frequency) $f_{HSCLK} = f_{HSDR} / W$	W = 2 to 32 (LVDS, HyperTransport technology) (2)	16	—	520	MHz
	W = 1 (SERDES bypass, LVDS only)	16	—	500	MHz
	W = 1 (SERDES used, LVDS only)	150	—	717	MHz

Table 4–41. HardCopy II High-Speed I/O Specifications for HC210, HC220, HC230 and HC240 Devices
Note (1) (Part 2 of 2)

Symbol	Conditions			Min	Typ	Max	Unit
f_{HSDR} (data rate)	J = 4 to 10 (LVDS, HyperTransport technology)			150	—	1,040	Mbps
	J = 2 (LVDS, HyperTransport technology)			(3)	—	760	Mbps
	J = 1 (LVDS only)			(3)	—	500	Mbps
f_{HSDRDPA} (DPA data rate)	J = 4 to 10 (LVDS, HyperTransport technology)			150	—	1,040	Mbps
TCCS	All differential standards			—	—	200	ps
SW	All differential standards			330	—	—	ps
Output jitter	—			—	—	190	ps
Output t_{RISE}	All differential I/O standards			—	—	160	ps
Output t_{FALL}	All differential I/O standards			—	—	180	ps
t_{DUTY}	—			45	50	55	%
DPA run length	—			—	—	6,400	UI
DPA jitter tolerance (peak-to-peak)	—			0.44	—	—	UI
DPA lock time	Standard	Training Pattern	Transition Density	—	—	—	Number of repetitions
	—	—	—	—	—	—	
	SPI4	0000000000 1111111111	10%	256	—	—	
	Parallel Rapid I/O	10010000	25%	256	—	—	
	—	10010000	50%	256	—	—	
	Miscellaneous	10101010	100%	256	—	—	
	—	10101010	—	256	—	—	

Notes to Table 4–41:

- When J = 4 to 10, the SERDES block is used.
When J = 1 or 2, the SERDES block is bypassed.
- The input clock frequency and the W factor must satisfy the following fast PLL VCO specification: $150 \leq \text{input clock frequency} \times W \leq 1,040$.
- The minimum specification is dependent on the clock source (fast PLL, enhanced PLL, clock pin, and so on) and the clock routing resource (global, regional, or local) used. The I/O differential buffer and input register do not have a minimum toggle rate.

PLL Timing Specifications

Tables 4–42 and 4–43 describe the HardCopy II PLL specifications when operating in both the commercial junction temperature range (0° to 85° C) and the industrial junction temperature range (–40° to 100° C), except for the clock switchover feature. Like the Stratix II devices, the clock switchover feature is only supported from the 0° to 100° C junction temperature range.

Table 4–42. HardCopy II Enhanced PLL Specifications (Part 1 of 2)

Name	Description	Min	Typ	Max	Unit
f_{IN}	Input clock frequency for HC210, HC220, HC230 and HC240 devices	2	—	500	MHz
	Input clock frequency for the HC210W device	2	—	320 (1)	MHz
f_{INPFD}	Input frequency to the PFD	2	—	420	MHz
f_{INDUTY}	Input clock duty cycle	40	—	60	%
$f_{EINDUTY}$	External feedback input clock duty cycle	40	—	60	%
$t_{INJITTER}$	Input or external feedback clock input jitter tolerance in terms of period jitter. Bandwidth \leq 0.85 MHz	—	0.5	—	ns (pp)
	Input or external feedback clock input jitter tolerance in terms of period jitter. Bandwidth $>$ 0.85 MHz	—	1	—	ns (pp)
$t_{OUTJITTER}$	Dedicated clock output period jitter for HC210, HC220, HC230 and HC240 devices	—	—	250 ps for \geq 100 MHz outclk 25 mUI for $<$ 100 MHz outclk	ps or mUI
	Dedicated clock output period jitter for HC210W device	—	—	300 ps for \geq 100 MHz outclk 30 mUI for $<$ 100 MHz outclk	ps or mUI
t_{FCOMP}	External feedback compensation time	—	—	10	ns
f_{OUT}	Output frequency for internal global or regional clock	1.5 (2)	—	550	MHz
$t_{OUTDUTY}$	Duty cycle for external clock output (when set to 50%).	45	50	55	%
$f_{SCANCLK}$	Scanclk frequency	—	—	100	MHz
$t_{CONFIGEPLL}$	Time required to reconfigure scan chains for enhanced PLLs	—	$174/f_{SCANCLK}$	—	ns
f_{OUT_EXT}	PLL external clock output frequency	1.5 (2)	—	(1)	MHz

Table 4–42. HardCopy II Enhanced PLL Specifications (Part 2 of 2)

Name	Description	Min	Typ	Max	Unit
t_{LOCK}	Time required for the PLL to lock from the time it is enabled or the end of device configuration	—	0.03	1	ms
t_{DLOCK}	Time required for the PLL to lock dynamically after automatic clock switchover between two identical clock frequencies	—	—	1	ms
$f_{\text{SWITCHOVER}}$	Frequency range where the clock switchover performs properly	4	—	500	MHz
f_{CLKW}	PLL closed loop bandwidth	0.13	1.2	16.9	MHz
f_{VCO}	PLL VCO operating range for HC210, HC220, HC230 and HC240 devices	300	—	1,040	MHz
	PLL VCO operating range for HC210W devices	300	—	840	MHz
f_{SS}	Spread spectrum modulation frequency	100	—	500	MHz
% spread	Percent down spread for a given clock frequency	0.4	0.5	0.6	%
$t_{\text{PLL_PSERR}}$	Accuracy of PLL phase shift	—	—	± 15	ps
t_{ARESET}	Minimum pulse width on ARESET signal.	10 (3)	—	—	ns
		500 (4)	—	—	ns
$t_{\text{ARESET_RECONFIG}}$	Minimum pulse width on the areset signal when using PLL reconfiguration. Reset the PLL after scan done goes high.	500	—	—	ns

Notes to Table 4–42:

- (1) Limited by I/O f_{MAX} .
- (2) If the counter cascading feature of the PLL is used, there is no minimum output clock frequency.
- (3) Applicable when the PLL input clock has been running continuously for at least 10 μs .
- (4) Applicable when the PLL input clock has stopped toggling or has been running continuously for less than 10 μs .

Table 4–43. HardCopy II Fast PLL Specifications (Part 1 of 2)

Name	Description	Min	Typ	Max	Unit
f_{IN}	Input clock frequency for HC210, HC220, HC230 and HC240 devices	16	—	717	MHz
	Input clock frequency for the HC210W device	16	—	320 (1)	MHz
f_{INPFD}	Input frequency to the PFD	16	—	500	MHz
f_{INDUTY}	Input clock duty cycle	40	—	60	%
$t_{INJITTER}$	Input clock jitter tolerance in terms of period jitter. Bandwidth ≤ 2 MHz	—	0.5	—	ns (pp)
	Input clock jitter tolerance in terms of period jitter. Bandwidth > 0.2 MHz	—	1	—	ns (pp)
f_{VCO}	Upper VCO frequency range for HC210, HC220, HC230 and HC240 devices	300	—	1,040	MHz
	Upper VCO frequency range for HC210W devices	300	—	840	MHz
	Lower VCO frequency range for HC210, HC220, HC230 and HC240 devices	150	—	520	MHz
	Lower VCO frequency range for HC210W device	150	—	420	MHz
f_{OUT}	PLL output frequency to GCLK or RCLK	4.6875	—	550	MHz
	PLL output frequency to LVDS or DPA clock for HC210, HC220, HC230 and HC240 devices	150	—	1,040	MHz
	PLL output frequency to LVDS or DPA clock for HC210W devices	150	—	840	MHz
f_{OUT_IO}	PLL clock output frequency to regular I/O pin	4.6875	—	(1)	MHz
$t_{CONFIGPLL}$	Time required to reconfigure scan chains for fast PLLs	—	$75/f_{SCANCLK}$	—	ns
f_{CLBW}	PLL closed loop bandwidth	1.16	5	28	MHz
t_{LOCK}	Time required for the PLL to lock from the time it is enabled or the end of the device configuration	—	0.03	1	ms
t_{PLL_PSERR}	Accuracy of PLL phase shift	—	—	± 30	ps
t_{ARESET}	Minimum pulse width on areset signal.	10	—	—	ns

Table 4–43. HardCopy II Fast PLL Specifications (Part 2 of 2)

Name	Description	Min	Typ	Max	Unit
t _{ARESET_RECONFIG}	Minimum pulse width on the areset signal when using PLL reconfiguration. Reset the PLL after scan done goes high.	500	—	—	ns

Note to Table 4–43:

- (1) Limited by I/O f_{MAX}.

External Memory Interface Specifications

Table 4–44 summarizes the maximum clock rate that HardCopy II devices can support with external memory devices.

Table 4–44. HardCopy II Maximum Clock Rate Support for External Memory Interfaces Note (1)

Memory Standards	HardCopy II Device				Unit
	Wire Bond Package HC210W (2)		Flip Chip Package HC210 / HC220 / HC230 / HC240 (3)		
	Com (C)	Ind (I)	Com (C)	Ind (I)	
DDR	150	133	200	200	MHz
DDR2 (7)	150	133	267	233	MHz
QDRII (6)	150	133	250	233 (5)	MHz
RLDRAMII (6)	150	133	250 (4)	233 (4)	MHz

Notes to Table 4–44:

- HardCopy II devices do not support PLL-based external memory interface except for SDR SDRAMs which do not require the DLL.
- HC210W supports memory interface on the top I/O banks.
- HC210 and HC220 support memory interface on the top I/O banks. HC230 and HC240 support memory interface on the top and bottom I/O banks.
- You will need to under-clock a 300 MHz memory device.
- You will need to under-clock a 250 MHz memory device.
- Based on a DDIO scheme with the 1.8-V HSTL I/O standard.
- Based on the PLL dedicated scheme. Use the same F_{MAX} specification for Static-PHY and Auto-PHY since the write-side is limited by the new tDS/tH specification.

Tables 4–45 through 4–51 contain HardCopy II device specifications for the dedicated circuitry used for interfacing with external memory devices.

Table 4–45. DLL Frequency Range Specifications

Frequency Mode	Frequency Range	Resolution (Degrees)
0	100 to 175	30
1	150 to 230	22.5
2	200 to 310	30
3	240 to 350	36

Table 4–46 lists the maximum delay in the fast timing model for the HardCopy II DQS delay buffer. Multiply the number of delay buffers that you are using in the DQS logic block to get the maximum delay achievable in your system. For example, if you implement a 90° phase shift at 200 MHz, you use three delay buffers in mode 2. The maximum achievable delay from the DQS block is then $3 \times .416 \text{ ps} = 1.248 \text{ ns}$.

Table 4–46. DQS Delay Buffer Maximum Delay in Fast Timing Model

DLL Frequency Mode	Maximum Delay Per Delay Buffer	Unit
0	0.833	ns
1, 2, 3	0.416	ns

Table 4–47. DQS Period Jitter Specifications for DLL-Delayed Clock (tDQS_JITTER) Note (1)

Number of DQS Delay Buffer Stages (2)	Commercial	Industrial	Unit
1	80	110	ps
2	110	130	ps
3	130	180	ps
4	160	210	ps

Notes to Table 4–47:

- (1) Peak-to-peak period jitter on the phase shifted DQS clock.
- (2) Delay stages used for requested DQS phase shift are reported in your project's Compilation Report in the Quartus II software.

Table 4–48. DQS Phase Jitter Specifications for DLL-Delayed Clock (tDQS_PHASE_JITTER) Note (1)

Number of DQS Delay Buffer Stages (2)	DQS Phase Jitter	Unit
1	30	ps
2	60	ps
3	90	ps
4	120	ps

Notes to Table 4–48:

- (1) Peak-to-peak phase jitter on the phase shifted DDS clock (digital jitter is caused by DLL tracking).
- (2) Delay stages used for requested DQS phase shift are reported in your project's Compilation Report in the Quartus II software.

Table 4–49. DQS Phase-Shift Error Specifications for DLL-Delayed Clock (tDQS_PSERR) Note (1)

Number of DQS Delay Buffer Stages (2)	HC210, HC220, HC230 HC240	Unit
1	30	ps
2	60	ps
3	90	ps
4	120	ps

Notes to Table 4–49:

- (1) This error specification is the absolute maximum and minimum error. For example, skew on three delay buffer stages with an HC240 device is 105 ps or ± 52.5 ps.
- (2) Delay stages used for requested DQS phase shift are reported in your project's Compilation Report in the Quartus II software.

Table 4–50. DQS Bus Clock Skew Adder Specifications (tDQS_CLOCK_SKEW_ADDER) Note (1)

Mode	DQS Clock Skew Adder	Unit
×4 DQ per DQS	40	ps
×9 DQ per DQS	70	ps
×18 DQ per DQS	75	ps
×36 DQ per DQS	95	ps

Note to Table 4–50:

- (1) This skew specification is the absolute maximum and minimum skew. For example, skew on a ×4 DQ group is 40 ps or ± 20 ps.

Table 4–51. DQS Phase Offset Delay Per Stage Note (1)

HardCopy II Devices	Min	Max	Unit
All	9	14	ps

Note to Table 4–51

- (1) The delay settings are linear. The valid settings for phase offset are -64 to +63 for frequency mode 0 and -32 to +31 for frequency modes 1, 2, and 3. The typical value equals the average of the minimum and maximum values.

Hot Socketing

HardCopy II devices offer hot socketing, which is also known as hot plug-in or hot swap, and power sequencing support without the use of any external devices. You can insert or remove a HardCopy II device in a system during system operation without causing undesirable effects to the running system bus or the board that was inserted into the system.

The hot socketing feature in HardCopy II devices allow:

- The device can be driven before power-up without any damage to the device itself.
- I/O pins remain tri-stated during power-up, so they do not disrupt bus operation when HardCopy II I/Os are inserted in the system.
- Signal pins do not drive the V_{CCIO} , V_{CCPD} , or V_{CCINT} power supplies.
- External input signals to I/O pins of the device do not internally power the V_{CCIO} or V_{CCINT} power supplies of the device via internal paths within the device.

In a hot socketing situation, a device's output buffers are turned off during system power-up or power-down. To simplify board design, HardCopy II devices support any power-up or power-down sequence (V_{CCIO} and V_{CCINT}). For mixed-voltage environments, you can drive signals into the device before or during power-up or power-down without damaging the device.

You can power up or power down the V_{CCIO} and V_{CCINT} pins in any sequence. The power supply ramp rates can range from 100 ns to 100 ms. All VCC supplies must power down within 100 ms of each other to prevent the I/O pins from driving out. During hot socketing, the I/O pin capacitance is less than 15 pF and the clock pin capacitance is less than 20 pF.

- The hot socketing DC specification is $|I_{IOPIN}| < 300 \mu\text{A}$.
- The hot socketing AC specification is $|I_{IOPIN}| < 8 \text{ mA}$ for 10 ns or less.



The DC specification applies when all VCC supplies to the device are stable in the powered-up or powered-down conditions. The AC specification applies when the device is being powered up or powered down in any of the conditions mentioned above.

Electrostatic Discharge

Electrostatic discharge (ESD) protection is a design practice that is integrated in Altera FPGAs and structured ASIC devices. HardCopy II devices are no exception, and they are designed with ESD protection on all I/O and power pins.

Figure 4-3 shows a typical HardCopy II CMOS I/O buffer structure which will be used to explain ESD protection.

Figure 4-3. Transistor-Level Diagram of HardCopy II Device I/O Buffers

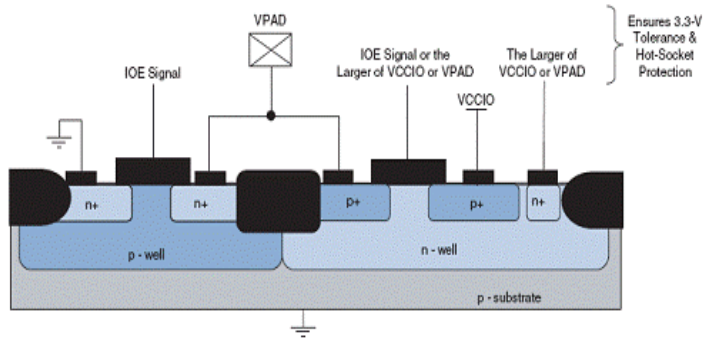

The CMOS output drivers in the I/O pins intrinsically provide electrostatic discharge protection. There are two cases to consider for ESD voltage strikes: positive voltage zap and negative voltage zap.

A positive ESD voltage zap occurs when a positive voltage is present on an I/O pin due to an ESD charge event. This can cause the N+ (Drain)/PSubstrate junction of the N-channel drain to break down and the N+ (Drain)/P-Substrate/N+ (Source) intrinsic bipolar transistor turns on to discharge ESD current from I/O pin to GND.

The dashed line (see Figure 4-4) shows the ESD current discharge path during a positive ESD zap.

Figure 4-4. ESD Protection During Positive Voltage Zap

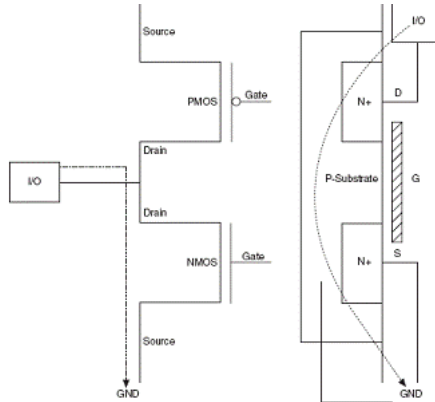

When the I/O pin receives a negative ESD zap at the pin that is less than -0.7 V (0.7 V is the voltage drop across a diode), the intrinsic P-Substrate/N+ drain diode is forward biased. Hence, the discharge ESD current path is from GND to the I/O pin, as shown in Figure 4-5.

Figure 4-5. ESD Protection During Negative Voltage Zap

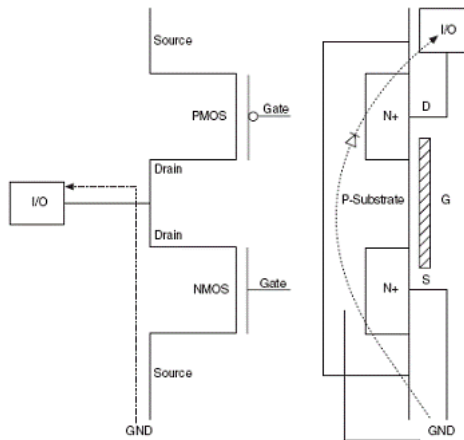

Details of ESD protection are also outlined in the *Hot-Socketing and Power-Sequencing Feature and Testing for Altera Devices* white paper located on the Altera website at www.altera.com.

For information on ESD results of Altera products, please see the Reliability Report on the Altera website at www.altera.com.

Document Revision History

Table 4–52 shows the revision history for this chapter.

Date and Document Version	Changes Made	Summary of Changes
September 2008, v3.3	Updated chapter number and metadata.	—
September 2007 v3.2	<ul style="list-style-type: none"> • Updated Table 4–33 and Table 4–34. • Updated drive strength value in Table 4–36. • Changed f_{IN} and f_{INPFD} from 4 to 2 MHz in Table 4–42. • Added industrial values to Table 4–44. 	Minor updates to correct information in tables.
June 2007 v3.1	<ul style="list-style-type: none"> • Changed V to V_{IH} in Table 4–16 • Updated data for V_{IH} in Table 4–17 • Added Table 4–29 • Updated Table 4–44 	—
December 2006 v3.0	<p>Major updates with new electrical characterization data</p> <ul style="list-style-type: none"> • Updated data in Table 4–1, Table 4–3, Table 4–4, Table 4–5, Table 4–10, Table 4–12, Table 4–13, Table 4–19, Table 4–20, Table 4–27 to Table 4–31. Added Table 4–11 and Tables 4–36 to Table 4–50. • Merged Tables 4–27 to Table 4–32 into new Tables 4–32 to Table 4–33. • Merged Tables 4–33 to Table 4–36 into new Tables 4–34 to Table 4–35. • Added revision history 	A major update to the chapter due to new electrical characterization data availability.
October 2005, v2.1	Updated graphics.	—
May 2005, v2.0	Updated various tables throughout chapter.	—
January 2005 v1.0	Added document to the HardCopy Series Handbook.	—

HardCopy II Device Support

Altera® HardCopy® II devices feature 1.2-V, 90 nm process technology, and provide a structured ASIC alternative to increasingly expensive multi-million gate ASIC designs. The HardCopy II design methodology offers a fast time-to-market schedule, providing ASIC designers with a solution to long ASIC development cycles. Using the Quartus® II software, you can leverage a Stratix® II FPGA as a prototype and seamlessly migrate your design to a HardCopy II device for production.

This document discusses the following topics:

- “HardCopy II Development Flow” on page 5-3
- “HardCopy II Device Resource Guide” on page 5-7
- “HardCopy II Recommended Settings in the Quartus II Software” on page 5-12
- “HardCopy II Utilities Menu” on page 5-25



For more information about HardCopy II, HardCopy Stratix, and HardCopy APEX™ devices, refer to the respective device data sheets in the *HardCopy Series Handbook*.

HardCopy II Design Benefits

Designing with HardCopy II structured ASICs offers substantial benefits over other structured ASIC offerings:

- Prototyping using a Stratix II FPGA for functional verification and system development reduces total project development time
- Seamless migration from a Stratix II FPGA prototype to a HardCopy II device reduces time to market and risk
- Unified design methodology for Stratix II FPGA design and HardCopy II design reduces the need for ASIC development software
- Low up-front development cost of HardCopy II devices reduces the financial risk to your project

Quartus II Features for HardCopy II Planning

With the Quartus II software you can design a HardCopy II device using a Stratix II device as a prototype. The Quartus II software contains the following expanded features for HardCopy II device planning:

- **HardCopy II Companion Device Assignment**—Identifies compatible HardCopy II devices for migration with the Stratix II device currently selected.



This feature constrains the pins of your Stratix II FPGA prototype making it compatible with your HardCopy II device. It also constrains the correct resources available for the HardCopy II device making sure that your Stratix II FPGA design does not become incompatible. In addition, you are still required to compile the design targeting the HardCopy II device to ensure that the design fits, routes, and meets timing.

- **HardCopy II Utilities**—The HardCopy II Utilities functions create or overwrites HardCopy II companion revisions, change revisions to use, and compare revisions for equivalency.
- **HardCopy II Advisor**—The HardCopy II Advisor helps you follow the necessary steps to successfully submit a HardCopy II design to Altera’s HardCopy Design Center.



The HardCopy II Advisor is similar to the Resource Optimization Advisor and Timing Optimization Advisor. The HardCopy II Advisor provides guidelines you can follow during development, reporting the tasks completed as well as the tasks that remain to be completed during development

- **HardCopy II Floorplan**—The Quartus II software can show a preliminary floorplan view of your HardCopy II design’s Fitter placement results.
- **HardCopy II Design Archiving**—The Quartus II software archives the HardCopy II design project’s files needed to handoff the design to the HardCopy Design Center.



This feature is similar to the Quartus II software HardCopy Files Wizard used for HardCopy Stratix and HardCopy APEX families.

- **HardCopy II Device Preliminary Timing**—The Quartus II software performs a timing analysis of HardCopy II devices based on preliminary timing models and Fitter placements. Final timing results for HardCopy II devices are provided by the HardCopy Design Center.
- **HardCopy II Handoff Report**—The Quartus II software generates a handoff report containing information about the HardCopy II design used by the HardCopy Design Center in the design review process.
- **Formal Verification**—Cadence Encounter Conformal software can now perform formal verification between the source RTL design files and post-compile gate level netlist from a HardCopy II design.

HardCopy II Development Flow

In the Quartus II software, you have two methods for designing your Stratix II FPGA and HardCopy II companion device together in one Quartus II project.

- Design the HardCopy II device first, and create the Stratix II FPGA companion device second and build your prototype for in-system verification
- Design the Stratix II FPGA first and create a HardCopy II companion device second

Both of these flows are illustrated at a high level in [Figure 5-1](#). The added features in the HardCopy II Utilities menu assist you in completing your HardCopy II design for submission to Altera's HardCopy Design Center for back-end implementation.

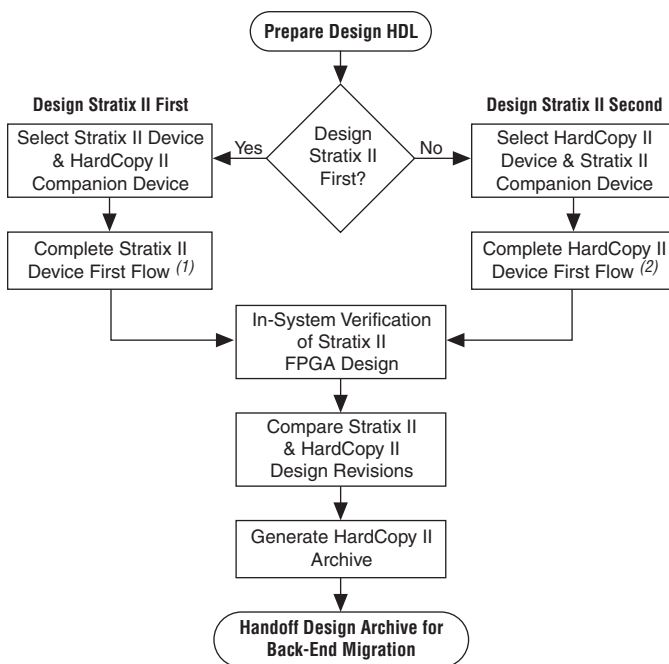
Figure 5–1. HardCopy II Flow in Quartus II Software

Notes for [Figure 5–1](#):

- (1) Refer to [Figure 5–2](#) for an expanded description of this process.
- (2) Refer to [Figure 5–3](#) for an expanded description of this process.

Designing the Stratix II FPGA First

The HardCopy II development flow beginning with the Stratix II FPGA prototype is very similar to a traditional Stratix II FPGA design flow, but requires a few additional tasks be performed to migrate the design to the HardCopy II companion device. To design your HardCopy II device using the Stratix II FPGA as a prototype, complete the following tasks:

- Specify a HardCopy II device for migration
- Compile the Stratix II FPGA design
- Create and compile the HardCopy II companion revision
- Compare the HardCopy II companion revision compilation to the Stratix II device compilation

[Figure 5–2](#) provides an overview highlighting the development process for designing with a Stratix II FPGA first and creating a HardCopy II companion device second.

Figure 5–2. Designing Stratix II Device First Flow

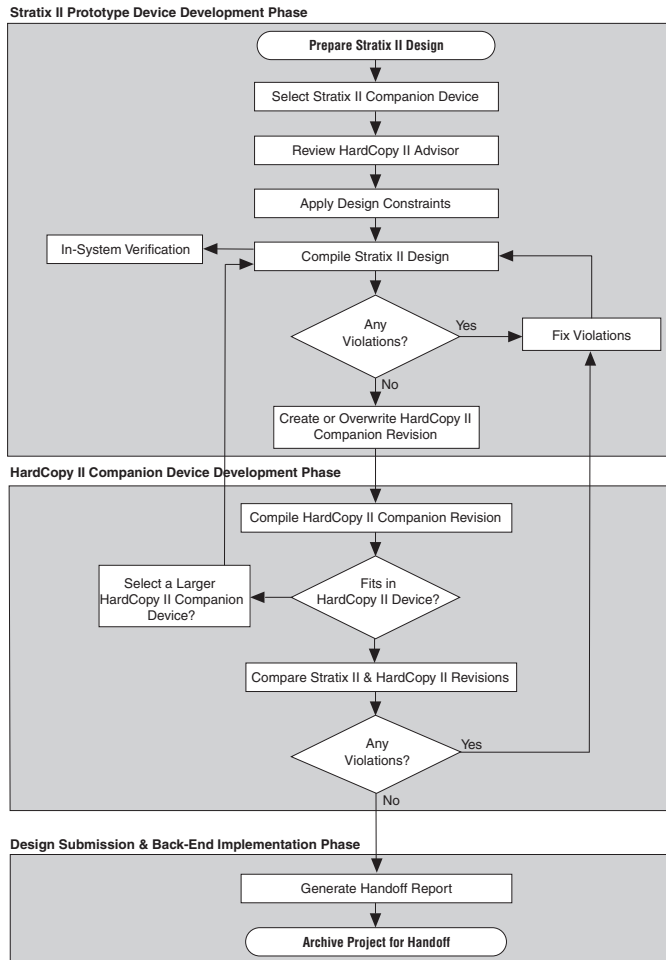

Prototype your HardCopy II design by selecting and then compiling a Stratix II device in the Quartus II software.

After you compile the Stratix II design successfully, you can view the HardCopy II Device Resource Guide in the Quartus II software Fitter report to evaluate which HardCopy II devices meet your design's resource requirements. When you are satisfied with the compilation results and the choice of Stratix II and HardCopy II devices, on the Assignments menu, click **Settings**. In the **Category** list, select **Device**. In the **Device** page, select a HardCopy II companion device.

After you select your HardCopy II companion device, do the following:

- Review the HardCopy II Advisor for required and recommended tasks to perform
- Enable Design Assistant to run during compilation
- Add timing and location assignments
- Compile your Stratix II design
- Create your HardCopy II companion revision
- Compile your design for the HardCopy II companion device
- Use the HardCopy II Utilities to compare the HardCopy II companion device compilation with the Stratix II FPGA revision
- Generate a HardCopy II Handoff Report using the HardCopy II Utilities
- Generate a HardCopy II Handoff Archive using the HardCopy II Utilities
- Arrange for submission of your HardCopy II handoff archive to Altera's HardCopy Design Center for back-end implementation



For more information about the overall design flow using the Quartus II software, refer to the *Introduction to Quartus II* manual on the Altera website at www.altera.com.

Designing the HardCopy II Device First

The HardCopy II family presents a new option in designing unavailable in previous HardCopy families. You can design your HardCopy II device first and create your Stratix II FPGA prototype second in the Quartus II software. This allows you to see your potential maximum performance in the HardCopy II device immediately during development, and you can create a slower performing FPGA prototype of the design for in-system verification. This design process is similar to the traditional HardCopy II design flow where you build the FPGA first, but instead, you merely change the starting device family. The remaining tasks to complete your design for both Stratix II and HardCopy II devices roughly follow the same process (Figure 5-3). The HardCopy II Advisor adjusts its list of tasks based on which device family you start with, Stratix II or HardCopy II, to help you complete the process seamlessly.

Figure 5–3. Designing HardCopy II Device First Flow

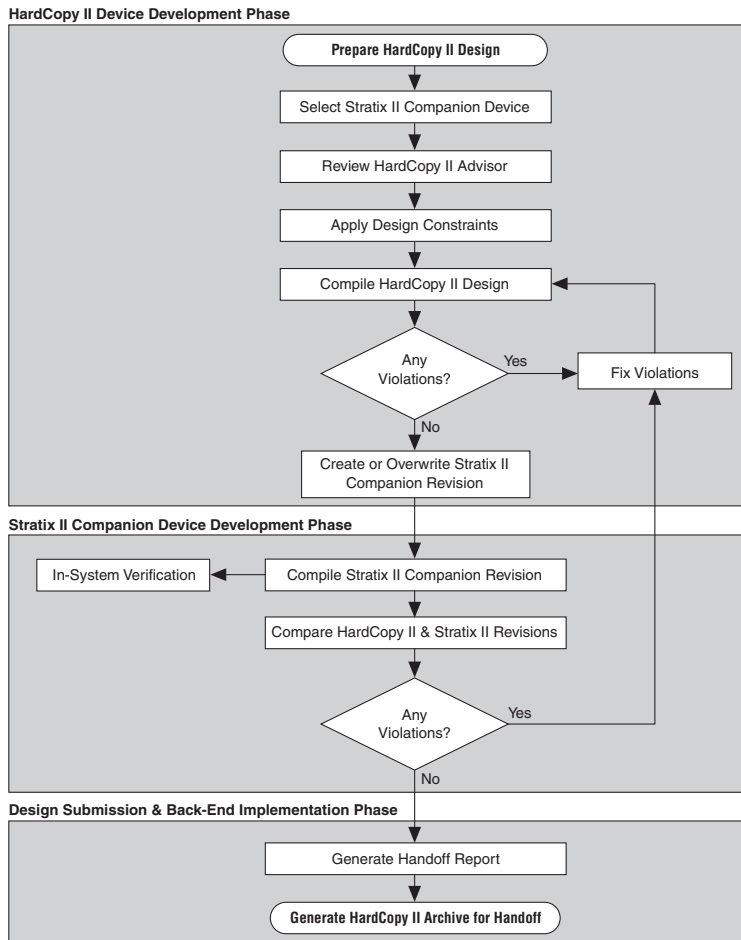

HardCopy II Device Resource Guide

The HardCopy II Device Resource Guide compares the resources required to successfully compile a design with the resources available in the various HardCopy II devices. The report rates each HardCopy II device and each device resource for how well it fits the design. The Quartus II software generates the HardCopy II Device Resource Guide for all designs successfully compiled for Stratix II devices. This guide is found in the Fitter folder of the Compilation Report. [Figure 5–4](#) shows an example of the HardCopy II Device Resource Guide. Refer to [Table 5–1](#) for an explanation of the color codes in [Figure 5–4](#).

Figure 5–4. HardCopy II Device Resource Guide

HardCopy II Device Resource Guide									
Color Legend: -- Green: -- Package Resource: The HardCopy II package can be migrated from the Stratix II FPGA selected package, and the design has been fitted with the target device migration enabled.									
Resource	Stratix II EP25130	HC210W*	HC210	HC220	HC220	HC230	HC240	HC240	
1 Migration Compatibility		None	None	None	None	Medium	None	None	
2 Primary Migration Constraint		Package	Package	Package	Package	Package	Package	Package	
3 Package	FBGA - 1020	FBGA - 484	FBGA - 484	FBGA - 672	FBGA - 780	FBGA - 1020	FBGA - 1020	FBGA - 1508	
4 Logic		19%	19%	10%	10%	6%	4%	4%	
5 -- Logic cells	35572 ALUTs	--	--	--	--	--	--	--	
6 -- DSP elements	0	--	--	--	--	--	--	--	
7 Pins									
8 -- Total	515	515 / 302	515 / 335	515 / 493	515 / 495	515 / 699	515 / 743	515 / 952	
9 -- Differential Input	0	0 / 66	0 / 70	0 / 90	0 / 90	0 / 128	0 / 224	0 / 272	
10 -- Differential Output	0	0 / 44	0 / 50	0 / 70	0 / 70	0 / 112	0 / 200	0 / 256	
11 -- PCI / PCI-X	0	0 / 153	0 / 167	0 / 245	0 / 247	0 / 359	0 / 367	0 / 472	
12 -- DQ	0	0 / 20	0 / 20	0 / 50	0 / 50	0 / 204	0 / 204	0 / 204	
13 -- DQS	0	0 / 8	0 / 8	0 / 18	0 / 18	0 / 72	0 / 72	0 / 72	
14 Memory									
15 -- M-RAM	6	6 / 0	6 / 0	6 / 2	6 / 2	6 / 6	6 / 9	6 / 9	
16 -- M4K blocks & M512 blocks**	44	44 / 190	44 / 190	44 / 408	44 / 408	44 / 614	44 / 816	44 / 816	
17 PLLs									
18 -- Enhanced	2	2 / 2	2 / 2	2 / 2	2 / 2	2 / 4	2 / 4	2 / 4	
19 -- Fast	0	0 / 2	0 / 2	0 / 2	0 / 2	0 / 4	0 / 8	0 / 8	
20 DLLs	0	0 / 1	0 / 1	0 / 1	0 / 1	0 / 2	0 / 2	0 / 2	
21 SERDES									
22 -- RX	0	0 / 17	0 / 21	0 / 31	0 / 31	0 / 46	0 / 92	0 / 116	
23 -- TX	0	0 / 18	0 / 19	0 / 29	0 / 29	0 / 44	0 / 88	0 / 116	
24 Configuration									
25 -- CRC	0	0 / 0	0 / 0	0 / 0	0 / 0	0 / 0	0 / 0	0 / 0	
26 -- ASMI	0	0 / 0	0 / 0	0 / 0	0 / 0	0 / 0	0 / 0	0 / 0	
27 -- Remote Update	0	0 / 0	0 / 0	0 / 0	0 / 0	0 / 0	0 / 0	0 / 0	
28 -- JTAG	0	0 / 1	0 / 1	0 / 1	0 / 1	0 / 1	0 / 1	0 / 1	
* Device is preliminary. Overall performance is expected to be degraded. ** Design contains one or more M512 blocks, which cannot be migrated to HardCopy II devices.									

Use this report to determine which HardCopy II device is a potential candidate for migration of your Stratix II design. The HardCopy II device package must be compatible with the Stratix II device package. A logic resource usage greater than 100% or a ratio greater than 1/1 in any category indicates that the design does not fit in that particular HardCopy II device.

Table 5–1. HardCopy II Device Resource Guide Color Legend

Color	Package Resource (1)	Device Resources
Green (High)	The design can migrate to the Hardcopy II package and the design has been fitted with target device migration enabled in the HardCopy II Companion Device dialog box.	The resource quantity is within the range of the HardCopy II device and the design can likely migrate if all other resources also fit. You are still required to compile the HardCopy II revision to make sure the design is able to route and migrate all other resources.
Orange (Medium)	The design can migrate to the Hardcopy II package. However, the design has not been fitted with target device migration enabled in the HardCopy II Companion Device dialog box.	The resource quantity is within the range of the HardCopy II device. However, the resource is at risk of exceeding the range for the HardCopy II package. If your target HardCopy II device falls in this category, compile your design targeting the HardCopy II device as soon as possible to check if the design fits and is able to route and migrate all other resources. You may need to migrate to a larger device.
Red (None)	The design cannot migrate to the Hardcopy II package.	The resource quantity exceeds the range of the HardCopy II device. The design cannot migrate to this HardCopy II device.

Note to Table 5–1:

- (1) The package resource is constrained by the Stratix II FPGA for which the design was compiled. Only vertical migration devices within the same package are able to migrate to HardCopy II devices.

The HardCopy II architecture consists of an array of fine-grained HCells, which are used to build logic equivalent to Stratix II adaptive logic modules (ALMs) and digital signal processing (DSP) blocks. The DSP blocks in HardCopy II devices match the functionality of the Stratix II DSP blocks, though timing of these blocks is different than the FPGA DSP blocks because they are constructed of HCell Macros. The M4K and M-RAM memory blocks in HardCopy II devices are equivalent to the Stratix II memory blocks. Preliminary timing reports of the HardCopy II device are available in the Quartus II software. Final timing results of the HardCopy II device are provided by the HardCopy Design Center after back-end migration is complete.



For more information about the HardCopy II device resources, refer to the *Introduction to HardCopy II Devices* and the *Description, Architecture and Features* chapters in the *HardCopy II Device Family Data Sheet* in the *HardCopy Series Handbook*.

The report example in [Figure 5–4](#) shows the resource comparisons for a design compiled for a Stratix II EP2S130F1020 device. Based on the report, the HC230F1020 device in the 1,020-pin FineLine BGA® package is an appropriate HardCopy II device to migrate to. If the HC230F1020 device is not specified as a migration target during the compilation, its package and migration compatibility is rated orange, or Medium. The migration compatibilities of the other HardCopy II devices are rated red, or None, because the package types are incompatible with the Stratix II device. The 1,020-pin FBGA HC240 device is rated red because it is only compatible with the Stratix II EP2S180F1020 device.

[Figure 5–5](#) shows the report after the (unchanged) design was recompiled with the HardCopy II HC230F1020 device specified as a migration target. Now the HC230F1020 device package and migration compatibility is rated green, or High.

Figure 5–5. HardCopy II Device Resource Guide with Target Migration Enabled

HardCopy II Device Resource Guide									
Color Legend: -- Green: -- Package Resource: The HardCopy II package can be migrated from the Stratix II FPGA selected package, and the design has been fitted with the target device migration enabled.									
Resource	Stratix II EP2S130	HC210W*	HC210	HC220	HC220	HC230	HC240	HC240	
1	Migration Compatibility	None	None	None	None	High	None	None	
2	Primary Migration Constraint	Package	Package	Package	Package	Package	Package	Package	
3	Package	FBGA - 1020	FBGA - 484	FBGA - 484	FBGA - 672	FBGA - 780	FBGA - 1020	FBGA - 1020	FBGA - 1508

HardCopy II Companion Device Selection

In the Quartus II software, you can select a HardCopy II companion device to help structure your design for migration from a Stratix II device to a HardCopy II device. To make your HardCopy II companion device selection, on the Assignments menu, click **Settings**. In the **Settings** dialog box in the **Category** list, select **Device** ([Figure 5–6](#)) and select your companion device from the **Available devices** list.

Selecting a HardCopy II Companion device to go with your Stratix II prototype constrains the memory blocks, DSP blocks, and pin assignments, so that your Stratix II and HardCopy II devices are migration-compatible. Pin assignments are constrained in the Stratix II design revision so that the HardCopy II device selected is pin-compatible. The Quartus II software also constrains the Stratix II design revision so it does not use M512 memory blocks or exceed the number of M-RAM blocks in the HardCopy II companion device.

Figure 5–6. Quartus II Settings Dialog Box

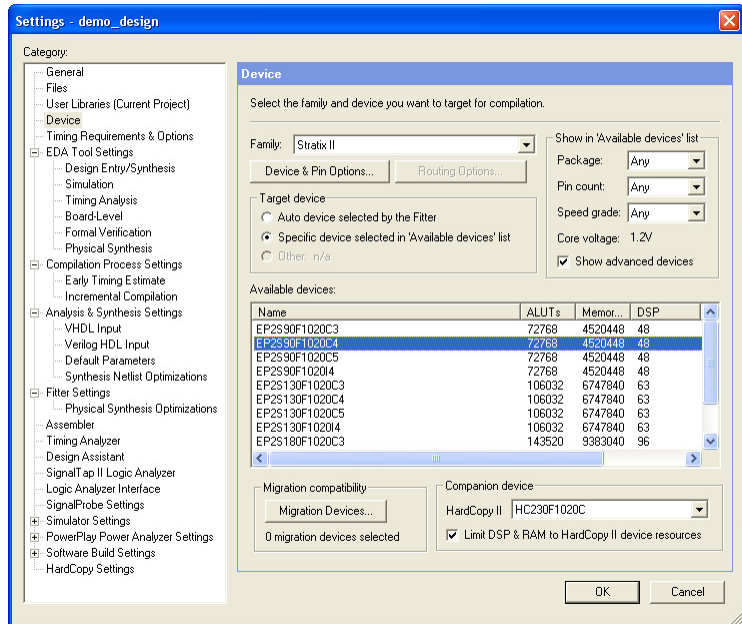

You can also specify your HardCopy II companion device using the following tool command language (Tcl) command:

```
set_global_assignment -name\
DEVICE_TECHNOLOGY_MIGRATION_LIST <HardCopy II Device Part Number>
```

For example, to select the HC230F1020 device as your HardCopy II companion device for the EP2S130F1020C4 Stratix II FPGA, the Tcl command is:

```
set_global_assignment -name\
DEVICE_TECHNOLOGY_MIGRATION_LIST HC230F1020C
```

HardCopy II Recommended Settings in the Quartus II Software

The HardCopy II development flow involves additional planning and preparation in the Quartus II software compared to a standard FPGA design. This is because you are developing your design to be implemented in two devices: a prototype of your design in a Stratix II prototype FPGA, and a companion revision in a HardCopy II device for production. You need additional settings and constraints to make the Stratix II design compatible with the HardCopy II device and, in some cases, you must remove certain settings in the design. This section explains the additional settings and constraints necessary for your design to be successful in both Stratix II FPGA and HardCopy II structured ASIC devices.

Limit DSP and RAM to HardCopy II Device Resources

On the Assignments menu, click **Settings** to view the **Settings** dialog box. In the **Category** list, select **Device**. In the **Family** list, select **Stratix II**. Under **Companion device**, **Limit DSP and RAM to HardCopy II device resources** is turned on by default (Figure 5–7). This maintains compatibility between the Stratix II and HardCopy II devices by ensuring your design does not use resources in the Stratix II device that are not available in the selected HardCopy II device.



If you require additional memory blocks or DSP blocks for debugging purposes using SignalTap® II, you can temporarily turn this setting off to compile and verify your design in your test environment. However, your final Stratix II and HardCopy II designs submitted to Altera for back-end migration must be compiled with this setting turned on.

Figure 5–7. Limit DSP and RAM to HardCopy II Device Resources Check Box

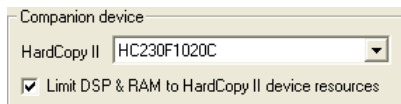

Enable Design Assistant to Run During Compile

You must use the Quartus II Design Assistant to check all HardCopy series designs for design rule violations before submitting the designs to the Altera HardCopy Design Center. Additionally, you must fix all critical and high-level errors.



Altera recommends turning on the Design Assistant to run automatically during each compile, so that during development, you can see the violations you must fix.



For more information about the Design Assistant and the rules it uses, refer to the *Design Guidelines for HardCopy Series Devices* chapter of the *HardCopy Series Handbook*.

To enable the Design Assistant to run during compilation, on the Assignment menu, click **Settings**. In the **Category** list, select **Design Assistant** and turn on **Run Design Assistant during compilation** (Figure 5–8) or by entering the following Tcl command in the Tcl Console:

```
set_global_assignment -name ENABLE_DRC_SETTINGS ON
```

Figure 5–8. Enabling Design Assistant

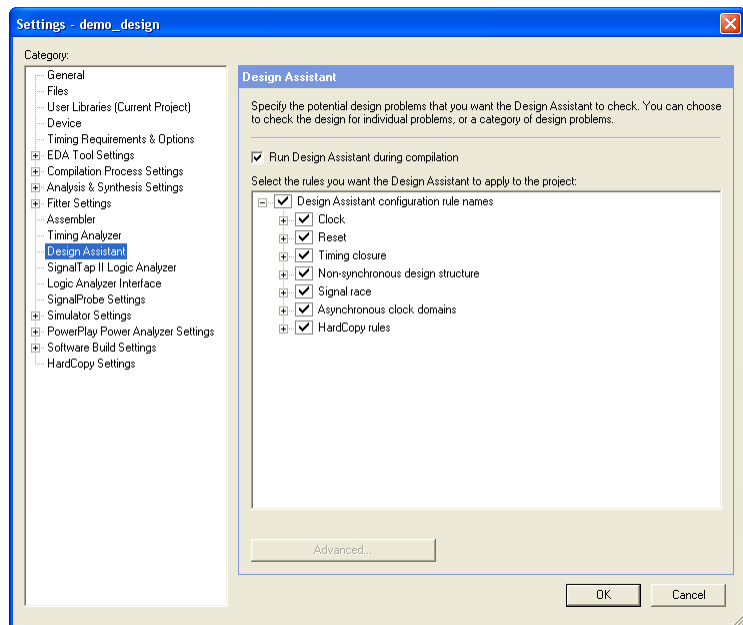

Timing Settings

Beginning in Quartus II Software version 7.1, TimeQuest is the recommended timing analysis tool for all designs. Classic Timing Analyzer is no longer supported and the HardCopy Design Center will not accept any designs which use Classic Timing Analyzer for timing closure.

If you are still using the Classic Timing Analyzer, Altera strongly recommends that you switch to TimeQuest.



For more information on how to switch to TimeQuest, refer to the *Switching to the TimeQuest Timing Analyzer* chapter of the *Quartus II Handbook*, volume 3, on the Altera website at www.altera.com.

When you specify the TimeQuest analyzer as the timing analysis tool, the TimeQuest analyzer guides the Fitter and analyzes timing results after compilation.

TimeQuest

The TimeQuest Timing Analyzer is a powerful ASIC-style timing analysis tool that validates timing in your design by using an industry-standard constraint, analysis, and reporting methodology. You can use the TimeQuest Timing Analyzer's GUI or command-line interface to constrain, analyze, and report results for all timing paths in your design.

Before running the TimeQuest Timing Analyzer, you must specify initial timing constraints that describe the clock characteristics, timing exceptions, and signal transition arrival and required times. You can specify timing constraints in the Synopsys Design Constraints (SDC) file format using the GUI or command-line interface. The Quartus II Fitter optimizes the placement of logic to meet your constraints.

During timing analysis, the TimeQuest Timing Analyzer analyzes the timing paths in the design, calculates the propagation delay along each path, checks for timing constraint violations, and reports timing results as slack in the Report pane and in the Console pane. If the TimeQuest Timing Analyzer reports any timing violations, you can customize the reporting to view precise timing information about specific paths, and then constrain those paths to correct the violations. When your design is free of timing violations, you can be confident that the logic will operate as intended in the target device.

The TimeQuest Timing Analyzer is a complete static timing analysis tool that you can use as a sign-off tool for Altera FPGAs and structured ASICs.

Setting Up the TimeQuest Timing Analyzer

If you want use TimeQuest for timing analysis, from the Assignments tab in the Quartus II software, click on **Timing Analysis Settings**, and in the pop-up window, click the **Use TimeQuest Timing Analyzer during compilation** tab.

Use the following Tcl command to use TimeQuest as your timing analysis engine:

```
set_global_assignment -name \
USE_TIMEQUEST_TIMING_ANALYZER ON
```

You can launch the TimeQuest analyzer in one of the following modes:

- Directly from the Quartus II software
- Stand-alone mode
- Command-line mode

In order to perform a thorough Static Timing Analysis, you would need to specify all the timing requirements. The most important timing requirements are clocks and generated clocks, input and output delays, false paths and multi-cycle paths, minimum and maximum delays.

In TimeQuest, clock latency, and recovery and removal analysis are enabled by default.



For more information about TimeQuest, refer to the *Quartus II TimeQuest Timing Analyzer* chapter in volume 3 of the *Quartus II Handbook* on the Altera website at www.altera.com.

Constraints for Clock Effect Characteristics

The `create_clock`, `create_generated_clock` commands create ideal clocks and do not account for board effects. In order to account for clock effect characteristics, you can use the following commands:

- `set_clock_latency`
- `set_clock_uncertainty`



For more information about how to use these commands, refer to the *Quartus II TimeQuest Timing Analyzer* chapter in volume 3 of the *Quartus II Handbook*.

Beginning in Quartus II version 7.1, you can use the new command `derive_clock_uncertainty` to automatically derive the clock uncertainties. This command is useful when you are not sure what the clock uncertainties might be. The calculated clock uncertainty values are based on I/O buffer, static phase errors (SPE) and jitter in the PLL's, clock networks, and core noises.

The `derive_clock_uncertainty` command applies inter-clock, intra-clock, and I/O interface uncertainties. This command automatically calculates and applies setup and hold clock uncertainties for each clock-to-clock transfer found in your design.

In order to get I/O interface uncertainty, you must create a virtual clock, then assign delays to the input/output ports by using the `set_input_delay` and `set_output_delay` commands for that virtual clock.



These uncertainties are applied in addition to those you specified using the `set_clock_uncertainty` command. However, if a clock uncertainty assignment for a source and destination pair was already defined, the new one will be ignored. In this case, you can use either the `-overwrite` command to overwrite the previous clock uncertainty command or manually remove them by using the `remove_clock_uncertainty` command.

The syntax for the `derive_clock_uncertainty` is as follows:

```
derive_clock_uncertainty [-h | -help] [-long_help]
[-dtw] [-overwrite]
```

where the arguments are listed in [Table 5-2](#):

Table 5-2. Arguments for <code>derive_clock_uncertainty</code>	
Option	Description
<code>-h -help</code>	Short help
<code>-long_help</code>	Long help with examples and possible return values
<code>-dtw</code>	Creates <code>PLLJ_PLLSPE_INFO.txt</code> file
<code>-overwrite</code>	Overwrites previously performed clock uncertainty assignments

When the `dtw` option is used, a `PLLJ_PLLSPE_INFO.txt` file is generated. This file lists the name of the PLLs, as well as their jitter and SPE values in the design. This text file can be used by `HCII_DTW_CU_Calculator`. When this option is used, clock uncertainties are not calculated.



For more information on the `derive_clock_uncertainty` command, refer to the *Quartus II TimeQuest Timing Analyzer* chapter in volume 3 of the *Quartus II Handbook*.

Altera strongly recommends that you use the `derive_clock_uncertainty` command in the HardCopy II revision. The HardCopy Design Center will not be accepting designs that do not have clock uncertainty constraint by either using the `derive_clock_uncertainty` command or the HardCopy II Clock Uncertainty Calculator, and then using the `set_clock_uncertainty` command.

For more information on how to use the HardCopy II Clock Uncertainty Calculator, refer to the *HardCopy II Clock Uncertainty User Guide* available on the Altera website at www.altera.com.

Quartus II Software Features Supported for HardCopy II Designs

The Quartus II software supports optimization features for HardCopy II prototype development, including:

- Physical Synthesis Optimization
- LogicLock Regions
- PowerPlay Power Analyzer
- Incremental Compilation (Synthesis and Fitter)
- Maximum Fan-Out Assignments

Physical Synthesis Optimization

To enable Physical Synthesis Optimizations for the Stratix II FPGA revision of the design, on the Assignments menu, click **Settings**. In the **Settings** dialog box, in the **Category** list, select **Fitter Settings**. These optimizations are migrated into the HardCopy II companion revision for placement and timing closure. When designing with a HardCopy II device first, physical synthesis optimizations can be enabled for the HardCopy II device, and these post-fit optimizations are migrated to the Stratix II FPGA revision.

LogicLock™ Regions

The use of LogicLock Regions in the Stratix II FPGA is supported for designs migrating to HardCopy II. However, LogicLock Regions are not passed into the HardCopy II Companion Revision. You can use LogicLock in the HardCopy II design but you must create new LogicLock Regions in the HardCopy II companion revision. In addition, LogicLock Regions in HardCopy II devices can not have their properties set to **Auto Size**. However, Floating LogicLock regions are supported. HardCopy II LogicLock Regions must be manually sized and placed in the floorplan. When LogicLock Regions are created in a HardCopy II device, they start with width and height dimensions set to (1,1), and the origin coordinates for placement are at X1_Y1 in the lower left corner of

the floorplan. You must adjust the size and location of the LogicLock Regions you created in the HardCopy II device before compiling the design.



For information about using LogicLock Regions, refer to the *Quartus II Analyzing and Optimizing Design Floorplan* chapter in volume 2 of the *Quartus II Handbook*.

PowerPlay Power Analyzer

You can perform power estimation and analysis of your HardCopy II and Stratix II devices using the PowerPlay Early Power Estimator. Use the PowerPlay Power Analyzer for more accurate estimation of your device's power consumption. The PowerPlay Early Power Estimator is available in the Quartus II software version 5.1 and later. The PowerPlay Power Analyzer supports HardCopy II devices in version 6.0 and later of the Quartus II software.



For more information about using the PowerPlay Power Analyzer, refer to the *Quartus II PowerPlay Power Analysis* chapter in volume 3 of the *Quartus II Handbook* on the Altera website at www.altera.com.

Incremental Compilation

The use of the Quartus II Incremental Compilation in the Stratix II FPGA is supported when migrating a design to a HardCopy II device. Incremental compilation is supported in the Stratix II First design flow or HardCopy II First design flow.

To take advantage of Quartus II Incremental Compilation, organize your design into logical and physical partitions for synthesis and fitting (or place-and-route). Incremental compilation preserves the compilation results and performance of unchanged partitions in your design. This feature dramatically reduces your design iteration time by focusing new compilations only on changed design partitions. New compilation results are then merged with the previous compilation results from unchanged design partitions. You can also target optimization techniques, such as physical synthesis, to specific partitions while leaving other partitions untouched.

In addition, be aware of the following guidelines:

- User partitions and synthesis results are migrated to a companion device.
- LogicLock regions are suggested for user partitions, but are not migrated automatically.

- The first compilation after migration to a companion device requires a full compilation (all partitions are compiled), but subsequent compilations can be incremental if changes to the source RTL are not required. For example, PLL phase changes can be implemented incrementally if the blocks are partitioned.
- The entire design must be migrated between Stratix II and HardCopy II companion devices. The Quartus II software does not support migration of partitions between companion devices.
- Bottom-up Quartus II Incremental Compilation is not supported for HardCopy II devices.
- Physical Synthesis can be run on individual partitions within the originating device only. The resulting optimizations are preserved in the migration to the companion device.



For information about using Quartus II Incremental Compilation, refer to the *Quartus II Incremental Compilation for Hierarchical and Team-Based Design* chapter in volume 1 of the *Quartus II Handbook*.

Maximum Fanout Assignments

This feature is supported beginning in Quartus II 6.1. In order to meet timing, it may be necessary to limit the number of fanouts of a net in your design. You can limit the maximum fanout of a given net by using this feature.

For example, you can use the following Tcl command to enable the maximum fanout setting:

```
set_instance_assignment -name MAX_FANOUT <number>
- to\ <net name>
```

For example, if you want to limit the maximum fanout of net called "m3122_combout_1" to 25, the Tcl command is as follows:

```
set_instance_assignment -name MAX_FANOUT 25 -to\
m3122_combout_1
```

Performing ECOs with Change Manager and Chip Planner

As designs grow larger and larger in density, the need to analyze the design for performance, routing congestion, logic placement, and executing Engineering Change Orders (ECOs) becomes critical. In addition to design analysis, you can use various bottom-up and top-down flows to implement and manage the design. This becomes difficult to manage since ECOs are often implemented as last minute changes to your design.

With the Altera® Chip Planner tool, you can shorten the design cycle time significantly. When changes are made to your design as ECOs, you do not have to perform a full compilation in the Quartus II software. Instead, you would make changes directly to the post place-and-route netlist, generate a new programming file, test the revised design by performing a gate-level simulation and timing analysis, and proceed to verify the fix on the system (if you are using a Stratix II FPGA as a prototype). Once the fix has been verified on the Stratix II FPGA, switch to the HardCopy II revision, apply the same ECOs, run the timing analyzer and assembler, perform a revision compare and then run the HardCopy II Netlist Writer for design submission.

There are three scenarios from a migration point of view:

- There are changes which can map one-to-one (that is, the same change can be implemented on each architecture—Stratix II FPGA and HardCopy II).
- There are changes that must be implemented differently on the two architectures to achieve the same result.
- There are some changes that cannot be implemented on both architectures.

The following sections outline the methods for migrating each of these types of changes.

Migrating One-to-One Changes

One-to-one changes are implemented using identical commands in both architectures. In general, such changes include those that affect only I/O cells or PLL cells. Some examples of one-to-one changes are changes such as creating, deleting or moving pins, changing pin or PLL properties, or changing pin connectivity (provided the source and destination of the connectivity changes are I/Os or PLLs). These can be implemented identically on both architectures.

If such changes are exported to Tcl, a direct reapplication of the generated Tcl script (with a minor text edit) on the companion revision should implement the appropriate changes as follows:

- Export the changes from the Change Manager to Tcl.
- Open the generated Tcl script, change the line "project_open <project> -revision <revision>" to refer to the appropriate companion revision.
- Apply the Tcl script to the companion revision.

A partial list of examples of this type are as follows:

- I/O creation, deletion, and moves
- I/O property changes (for example, I/O standards, delay chain settings, etc.)
- PLL property changes
- Connectivity changes between non-LCELL_COMB atoms (for example, PLL to I/O, DSP to I/O, etc.)

Migrating Changes that must be Implemented Differently

Some changes must be implemented differently on the two architectures. Changes affecting the logic of the design may fall into this category. Examples are LUTMASK changes, LC_COMB/HSADDER creation and deletion, and connectivity changes not covered in the previous section.

Another example of this would be to have different PLL settings for the Stratix II and the HardCopy II revisions.



For more information about how to use different PLL settings for the Stratix II and HardCopy II Devices, refer to *AN432: Using Different PLL Settings Between Stratix II and HardCopy II Devices*.

Table 5–3 summarizes suggested implementation for various changes.

Change Type	Suggested Implementation
LUTMASK changes	Because a single Stratix II atom may require multiple HardCopy II atoms to implement, it may be necessary to change multiple HardCopy II atoms to implement the change, including adding or modifying connectivity
Make/Delete LC_COMB	If you are using a Stratix II LC_COMB in extended mode (7-LUT) or using a SHARE chain, you must create multiple atoms to implement the same logic functions in HardCopy II. Additionally, the placement of the LC_COMB cell has no meaning in the companion revision as the underlying resources are different.

Table 5–3. Implementation Suggestions for Various Changes (Part 2 of 2)

Change Type	Suggested Implementation
Make/Delete LC_FF	The basic creation and deletion is the same on both architectures. However, as with LC_COMB creation and deletion, the location of an LC_FF in a HardCopy II revision has no meaning in the Stratix II revision and vice versa.
Editing Logic Connectivity	Because a Stratix II LCELL_COMB atom may have to be broken up into several HardCopy II LCELL_COMB atoms, the source or destination ports for connectivity changes may need to be analyzed to properly implement the change in the companion revision.

Changes that Cannot be Migrated

A small set of changes cannot be implemented in the other architecture because they do not make sense in the other architecture. The best example of this occurs when moving logic in a design; because the logic fabric is different between the two architectures, locations in Stratix II make no sense in HardCopy II and vice versa.

Overall Migration Flow

This section outlines the migration flow and the suggested procedure for implementing changes in both revisions to ensure a successful Revision Compare such that the design can be submitted to the HardCopy Design Center.

Preparing the Revisions

The general procedure for migrating changes between devices is the same, whether going from Stratix II to HardCopy II or vice versa. The major steps are as follows:

1. Compile the design on the initial device.
2. Migrate the design from the initial device to the target device in the companion revision.
3. Compile the companion revision.
4. Perform a Revision Compare operation. The two revisions should pass the Revision Compare.

If testing identifies problems requiring ECO changes, equivalent changes can be applied to both Stratix II and HardCopy II revisions, as described in the next section.

Applying ECO Changes

The general flow for applying equivalent changes in companion revisions is as follows:

1. Make changes in one revision using the Chip Planner tools (Chip Planner, Resource Property Editor, and Change Manager), then verify and export these changes. The procedure for doing this is as follows:
 - a. Make changes using the Chip Planner tool.
 - b. Perform a netlist check using the Check and Save All Netlist Changes command.
 - c. Verify correctness using timing analysis, simulation, and prototyping (Stratix II only). If more changes are required, repeat steps a-b.
 - d. Export change records from the Change Manager to Tcl scripts, or **.csv** or **.txt** file formats.

This exported file is used to assist in making the equivalent changes in the companion revision.

2. Open the companion revision in the Quartus II software.
3. Using the exported file, manually reapply the changes using the Chip Planner tool.

As stated previously, some changes can be reapplied directly to the companion revision (either manually or by applying the Tcl commands), while others require some modifications.

4. Perform a Revision Compare operation. The revisions should now match once again.
5. Verify the correctness of all changes (you may need to run timing analysis).
6. Run the HardCopy II Assembler and the HardCopy II Netlist Writer for design submission along with handoff files.

The Tcl command for running the HardCopy II Assembler is as follows:

```
execute_module -tool asm -args "--  
read_settings_files=\ off --write_settings_files=off"
```

The Tcl command for the HardCopy II Netlist Writer is as follows:

```
execute_module -tool cdb -args "--  
generate_hardcopyii_files\"
```



For more information about using Chip Planner, refer to the *Quartus II Engineering Change Management with Chip Planner* chapter in volume 3 of the *Quartus II Handbook* at www.altera.com.

Formal Verification of Stratix II and HardCopy II Revisions

Third-party formal verification software is available for your HardCopy II design. Cadence Encounter Conformal verification software is used for Stratix II and HardCopy II families, as well as several other Altera product families.

To use the Conformal software with the Quartus II software project for your Stratix II and HardCopy II design revisions, you must enable the **EDA Netlist Writer**. It is necessary to turn on the EDA Netlist Writer so it can generate the necessary netlists and command files needed to run the Conformal software. To automatically run the EDA Netlist Writer during the compile of your Stratix II and HardCopy II design revisions, perform the following steps:

1. On the Assignment menu, click **EDA Tool Settings**. The **Settings** dialog box displays.
2. In the **EDA Tool Settings** list, select **Formal Verification**, and in the **Tool name** list, select **Conformal LEC**.
3. Compile your Stratix II and HardCopy II design revisions, with both the EDA Tool Settings and the Conformal LEC turned on so the EDA Netlist Writer automatically runs.

The Quartus II EDA Netlist Writer produces one netlist for Stratix II when it is run on that revision, and generates a second netlist when it runs on the HardCopy II revision. You can compare your Stratix II post-compile netlist to your RTL source code using the scripts generated by the EDA Netlist Writer. Similarly, you can compare your HardCopy II post-compile netlist to your RTL source code with scripts provided by the EDA Netlist Writer.



For more information about using the Cadence Encounter Conformal verification software, refer to the *Cadence Encounter Conformal Support* chapter in volume 3 of the *Quartus II Handbook*.

HardCopy II Utilities Menu

The **HardCopy II Utilities** menu in the Quartus II software is shown [Figure 5–9](#). To access this menu, on the Project menu, click **HardCopy II Utilities**. This menu contains the main functions you use to develop your HardCopy II design and Stratix II FPGA prototype companion revision. From the HardCopy II Utilities menu, you can:

- Create or update HardCopy II companion revisions
- Set which HardCopy II companion revision is the current revision
- Generate a HardCopy II Handoff Report for design reviews
- Archive HardCopy II Handoff Files for submission to the HardCopy Design Center
- Compare the companion revisions for functional equivalence
- Track your design progress using the HardCopy II Advisor

Figure 5–9. HardCopy II Utilities Menu

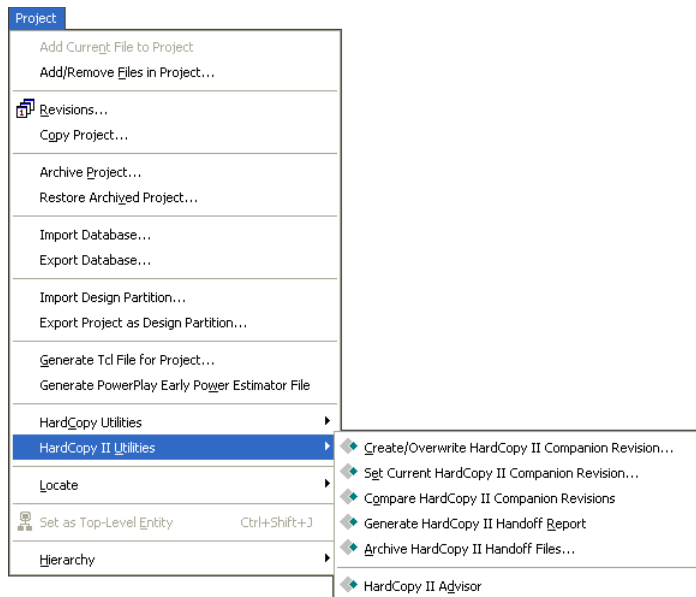

Each of the features within **HardCopy II Utilities** is summarized in [Table 5-4](#). The process for using each of these features is explained in the following sections.

Menu	Description	Applicable Design Revision	Restrictions
Create/Overwrite HardCopy II Companion Revision	Create a new companion revision or update an existing companion revision for your Stratix II and HardCopy II design.	Stratix II prototype design and HardCopy II Companion Revision	<ul style="list-style-type: none"> • Must disable Auto Device selection • Must set a Stratix II device and a HardCopy II companion device
Set Current HardCopy II Companion Revision	Specify which companion revision to associate with current design revision.	Stratix II prototype design and HardCopy II Companion Revision	Companion Revision must already exist
Compare HardCopy II Companion Revisions	Compares the Stratix II design revision with the HardCopy II companion design revision and generates a report.	Stratix II prototype design and HardCopy II Companion Revision	Compilation of both revisions must be complete
Generate HardCopy II Handoff Report	Generate a report containing important design information files and messages generated by the Quartus II compile	Stratix II prototype design and HardCopy II Companion Revision	<ul style="list-style-type: none"> • Compilation of both revisions must be complete • Compare HardCopy II Companion Revisions must have been executed
Archive HardCopy II Handoff Files	Generate a Quartus II Archive File specifically for submitting the design to the HardCopy Design Center. Similar to the HardCopy Files Wizard for HardCopy Stratix and APEX.	HardCopy II Companion Revision	<ul style="list-style-type: none"> • Compilation of both revisions must be completed • Compare HardCopy II Companion Revisions must have been executed • Generate HardCopy Handoff Report must have been executed
HardCopy II Advisor	Open an Advisor, similar to the Resource Optimization Advisor, helping you through the steps of creating a HardCopy II project.	Stratix II prototype design and HardCopy II Companion Revision	None

Companion Revisions

HardCopy II designs follow a different development flow in the Quartus II software compared with previous HardCopy families. You can create multiple revisions of your Stratix II prototype design, but you can also create separate revisions of your design for a HardCopy II device.

The Quartus II software creates specific HardCopy II design revisions of the project in conjunction to the regular project revisions. These parallel design revisions for HardCopy II devices are called companion revisions.



Although you can create multiple project revisions, Altera recommends that you maintain only one Stratix II FPGA revision once you have created the HardCopy II companion revision.

When you have successfully compiled your Stratix II prototype FPGA, you can create a HardCopy II companion revision of your design and proceed with compiling the HardCopy II companion revision. To create a companion revision, on the Project menu, point to HardCopy II Utilities and click **Create/Overwrite HardCopy II Companion Revision**. Use the dialog box to create a new companion revision or overwrite an existing companion revision (Figure 5–10).

Figure 5–10. Create or Overwrite HardCopy II Companion Revision

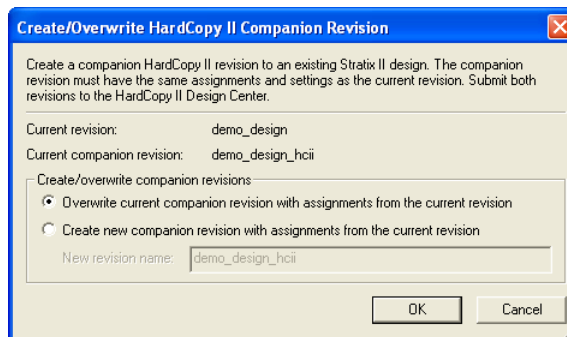

You can associate only one Stratix II revision to one HardCopy II companion revision. If you created more than one revision or more than one companion revision, set the current companion for the revision you are working on. On the Project menu, point to HardCopy II Utilities and click **Set Current HardCopy II Companion Revision** (Figure 5–11).

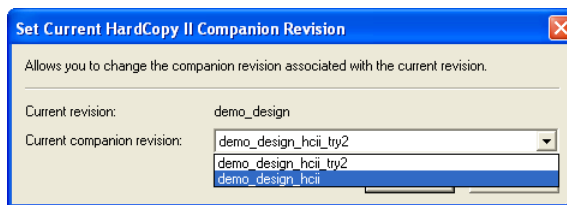
Figure 5–11. Set Current HardCopy II Companion Revision

Compiling the HardCopy II Companion Revision

The Quartus II software allows you to compile your HardCopy II design with preliminary timing information. The timing constraints for the HardCopy II companion revision can be the same as the Stratix II design used to create the revision. The Quartus II software contains preliminary timing models for HardCopy II devices and you can gauge how much performance improvement you can achieve in the HardCopy II device compared to the Stratix II FPGA. Altera verifies that the HardCopy II Companion Device timing requirements are met in the HardCopy Design Center.

After you create your HardCopy II companion revision from your compiled Stratix II design, select the companion revision in the Quartus II software design revision drop-down box (Figure 5–12) or from the **Revisions** list. Compile the HardCopy II companion revision. After the Quartus II software compiles your design, you can perform a comparison check of the HardCopy II companion revision to the Stratix II prototype revision.

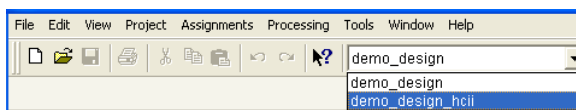
Figure 5–12. Changing Current Revision

Comparing HardCopy II and Stratix II Companion Revisions

Altera uses the companion revisions in a single Quartus II project to maintain the seamless migration of your design from a Stratix II FPGA to a HardCopy II structured ASIC. This methodology allows you to design with one set of Register Transfer Level (RTL) code to be used in both Stratix II FPGA and HardCopy II structured ASIC, guaranteeing functional equivalency.

When making changes to companion revisions, use the Compare HardCopy II Companion Revisions feature to ensure that your Stratix II design matches your HardCopy II design functionality and compilation settings. To compare companion revisions, on the Project menu, point to HardCopy II Utilities and click **Compare HardCopy II Companion Revisions**.



You must perform this comparison after both Stratix II and HardCopy II designs are compiled in order to hand off the design to Altera's HardCopy Design Center

The Comparison Revision Summary is found in the Compilation Report and identifies where assignments were changed between revisions or if there is a change in the logic resource count due to different compilation settings.

Generate HardCopy II Handoff Report

In order to submit a design to the HardCopy Design Center, you must generate a HardCopy II Handoff Report providing important information about the design that you want the HardCopy Design Center to review. To generate the HardCopy II Handoff Report, you must:

- Successfully compile both Stratix II and HardCopy II revisions of your design
- Successfully run the Compare HardCopy II Companion Revisions utility

Once you generate the HardCopy II Handoff Report, you can archive the design using the Archive HardCopy II Handoff Files utility described in [“Archive HardCopy II Handoff Files” on page 5-29](#).

Archive HardCopy II Handoff Files

The last step in the HardCopy II design methodology is to archive the HardCopy II project for submission to the HardCopy Design Center for back-end migration. The HardCopy II archive utility creates a different Quartus II Archive File than the standard Quartus II project archive

utility generates. This archive contains only the necessary data from the Quartus II project needed to implement the design in the HardCopy Design Center.

In order to use the **Archive HardCopy II Handoff Files** utility, you must complete the following:

- Compile both the Stratix II and HardCopy II revisions of your design
- Run the Compare HardCopy II Revisions utility
- Generate the HardCopy II Handoff Report

To select this option, on the Project menu, point to HardCopy II Utilities and click **Archive HardCopy II Handoff File** utility.

HardCopy II Advisor

The HardCopy II Advisor provides the list of tasks you should follow to develop your Stratix II prototype and your HardCopy II design. To run the HardCopy II Advisor, on the Project menu, point to HardCopy II Utilities and click **HardCopy II Advisor**. The following list highlights the checkpoints that the HardCopy II Advisor reviews. This list includes the major check points in the design process; it does not show every step in the process for completing your Stratix II and HardCopy II designs:

1. Select a Stratix II device.
2. Select a HardCopy II device.
3. Turn on the **Design Assistant**.
4. Set up timing constraints.
5. Check for incompatible assignments.
6. Compile and check the Stratix II design.
7. Create or overwrite the companion revision.
8. Compile and check the HardCopy II companion results.
9. Compare companion revisions.
10. Generate a Handoff Report.
11. Archive Handoff Files and send to Altera.

The HardCopy II Advisor shows the necessary steps that pertain to your current selected device. The Advisor shows a slightly different view for a design with Stratix II selected as compared to a design with HardCopy II selected.

In the Quartus II software, you can start designing with the HardCopy II device selected first, and build a Stratix II companion revision second. When you use this approach, the HardCopy II Advisor task list adjusts automatically to guide you from HardCopy II development through Stratix II FPGA prototyping, then completes the comparison archiving and handoff to Altera.

When your design uses the Stratix II FPGA as your starting point, Altera recommends following the Advisor guidelines for your Stratix II FPGA until you complete the prototype revision.

When the Stratix II FPGA design is complete, create and switch to your HardCopy II companion revision and follow the Advisor steps shown in that revision until you are finished with the HardCopy II revision and are ready to submit the design to Altera for back-end migration.

Each category in the HardCopy II Advisor list has an explanation of the recommended settings and constraints, as well as quick links to the features in the Quartus II software that are needed for each section. The HardCopy II Advisor displays:

- A green check box when you have successfully completed one of the steps
- A yellow caution sign for steps that must be completed before submitting your design to Altera for HardCopy development
- An information callout for items you must verify



Selecting an item within the HardCopy II flow menu provides a description of the task and recommended action. The view in the HardCopy II Advisor differs depending on the device you select.

Figure 5–13 shows the HardCopy II Advisor with the Stratix II device selected.

Figure 5–13. HardCopy II Advisor with Stratix II Selected

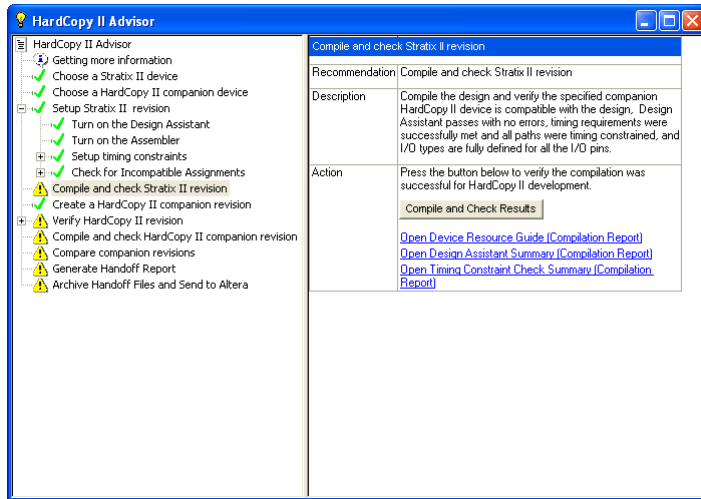
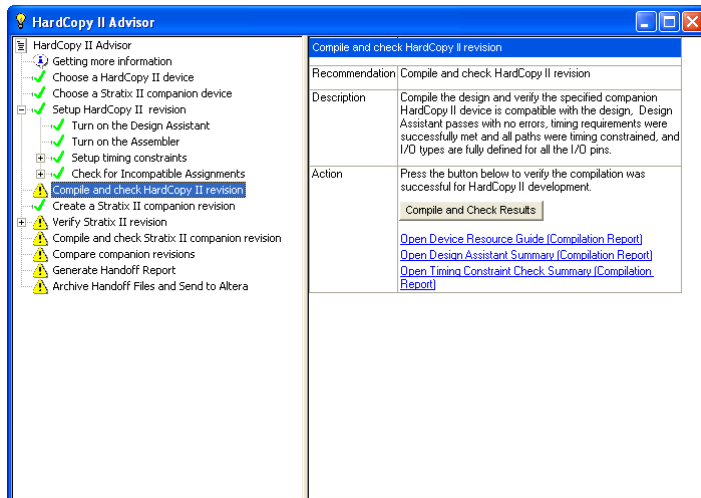

Figure 5–14 shows the HardCopy II Advisor with the HardCopy II device selected.

Figure 5–14. HardCopy II Advisor with HardCopy II Device Selected



HardCopy II Floorplan View

The Quartus II software displays the preliminary timing closure floorplan and placement of your HardCopy II companion revision. This floorplan shows the preliminary placement and connectivity of all I/O pins, PLLs, memory blocks, HCell macros, and DSP HCell macros. Congestion mapping of routing connections can be viewed using the **Layers Setting** dialog box (in the View menu) settings. This is useful in analyzing densely packed areas of your floorplan that could be reducing the peak performance of your design. The HardCopy Design Center verifies final HCell macro timing and placement to guarantee timing closure is achieved.

Figure 5–15 shows an example of the HC230F1020 device floorplan.

Figure 5–15. HC230F1020 Device Floorplan

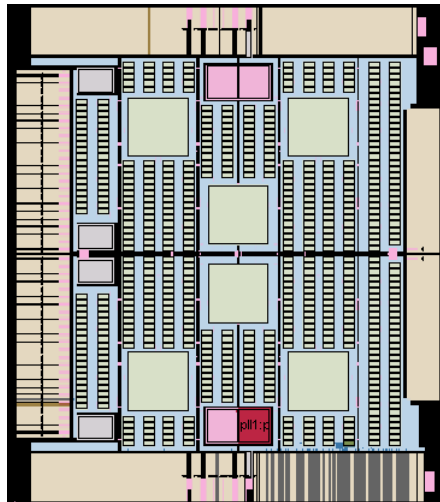

In this small example design, the logic is placed near the bottom edge. You can see the placement of a DSP block constructed of HCell Macros, various logic HCell Macros, and an M4K memory block. A labeled close-up view of this region is shown in Figure 5–16.

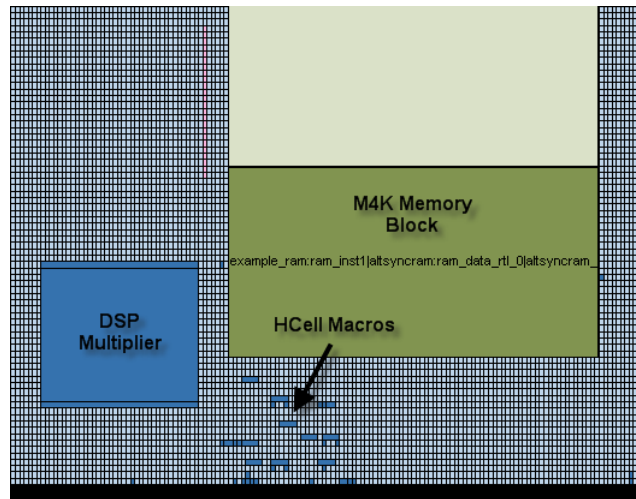
Figure 5–16. Close-Up View of Floorplan

The HardCopy Design Center performs final placement and timing closure on your HardCopy II design based on the timing constraints provided in the Stratix II design.



For more information about the HardCopy Design Center's process, refer to the *Back-End Design Flow for HardCopy Series Devices* chapter in volume 1 of the *HardCopy Series Device Handbook*.

Conclusion

You can use the Quartus II software to design HardCopy II devices and to develop prototypes using Stratix II FPGAs. This is done using the standard FPGA development process with the addition of the HardCopy II Device Resource Guide, HardCopy II Companion Devices assignment HardCopy II Utilities, and the HardCopy II Advisor.

The addition of the HardCopy II Advisor to the Quartus II software provides an instrumental development guide for you to complete your HardCopy II and Stratix II device designs. The HardCopy II Utilities included in the Quartus II software provide you with the tools necessary to complete your Stratix II FPGA prototype and HardCopy II structured ASIC design. The addition of the HardCopy II companion revisions feature to the process allows for rapid development and verification that your HardCopy II design is functionally equivalent to your Stratix II FPGA prototype.

Document Revision History

Table 5–5 shows the revision history for this chapter.

Date and Document Version	Changes Made	Summary of Changes
September 2008, v2.5	Updated chapter number and metadata.	—
June 2007 v2.4	Updated with the current Quartus II software version 7.1 information.	—
December 2006 v2.3	Minor updates for the Quartus II software version 6.1.0 <ul style="list-style-type: none"> • Added “Performing ECOs with Change Manager and Chip Planner” and “Overall Migration Flow” sections. • Updated “Quartus II Software Features Supported for HardCopy II Designs” section. 	A medium update to the chapter, due to changes in the Quartus II software version 6.1 release; most changes were in the “Performing ECOs with Change Manager and Chip Planner” and “Overall Migration Flow” sections.
May 2006, v2.2	Added information on support for HardCopy II devices in version 6.0 of the Quartus II software.	—
March 2006	Formerly chapter 18; no content change.	—
October 2005 v2.1	<ul style="list-style-type: none"> • Moved <i>Chapter 17 Quartus II Support for HardCopy II Devices</i> to Chapter 18 in <i>Hardcopy Series Device Handbook 3.2</i>. • Updated Graphics. • Updated technical content for Quartus II 5.1 support of HardCopy II devices. 	—
May 2005 v2.0	Added information on support for HardCopy II devices in version 5.0 of the Quartus II software.	—
January 2005 v1.0	Added document to the <i>HardCopy Series Handbook</i> .	—

Introduction

The Quartus® II software includes a set of command-line executables, many of which support an interactive Tcl shell. Using the Tcl shell, you can perform FPGA or HardCopy® design operations without using the Quartus® II window-based GUI.

This chapter provides an introduction to Tcl operations for script-based HardCopy II design using the interactive Tcl shell. Topics covered in this chapter include:

- Overview of Tcl scripting features in the Quartus II software
- HardCopy II design flow
- Applying location and timing constraints
- Synthesis, place and route for HardCopy II designs, and Stratix® II prototypes
- Design verification and analysis

Tcl Support in the Quartus II Software

The Quartus II software provides different ways to execute Tcl commands and scripts, including:

- A Tcl Console window
- A Tcl Scripts dialogue box
- Command-line processing
- An interactive Tcl shell

The Tcl Console window and **Tcl Scripts** dialogue box both run within the Quartus II GUI and are not described here. Instead, this chapter focuses on the Interactive Tcl shell that you can use with the Quartus II command-line executables.



For more information about command-line processing and the use of Quartus II command-line executables in batchfiles, makefiles, and scripts, refer to the *Command-Line Scripting* chapter in volume 2 of the *Quartus II Handbook*.



For more information on the Quartus II Tcl implementation, refer to the *Tcl Reference Manual* and the *Tcl Scripting* chapter of the *Quartus II Handbook*.

Interactive Tcl Shell

A number of the Quartus II executables can be run with an interactive Tcl shell as the user interface. These executables are identified in [Table 6-1](#). The interactive Tcl shell supports Tcl version 8.4.

Table 6-1. Quartus II Command-Line Executables with Interactive Tcl Support

Executable Name	Description
quartus_sh	A basic Tcl interpreter shell. Supports assignment specification, compile operations, and native operating system commands. For more information, refer to <code>quartus_sh</code> in the <i>Command-Line Executables</i> section of the <i>Quartus II Scripting Reference Manual</i> .
quartus_sta	The Quartus II TimeQuest timing analyzer engine supports building the timing graph for the design and timing analysis Tcl commands. For more information, refer to <code>quartus_sta</code> in the <i>Command-Line Executables</i> section of the <i>Quartus II Scripting Reference Manual</i> .
quartus_tan	The Quartus II Classic Timing Analyzer engine supports building the timing graph for the design and timing analysis Tcl commands. For more information, refer to <code>quartus_tan</code> in the <i>Command-Line Executables</i> section of the <i>Quartus II Scripting Reference Manual</i> .
quartus_cdb	The Quartus II database interface executable. Supports operations related to the design database such as LogicLock, back-annotation, and FPGA-HardCopy comparison for HardCopy II designs. For more information, refer to <code>quartus_cdb</code> in the <i>Command-Line Executables</i> section of the <i>Quartus II Scripting Reference Manual</i> .
quartus_sim	The Quartus II Simulator. For more information, refer to <code>quartus_sim</code> in the <i>Command-Line Executables</i> section of the <i>Quartus II Scripting Reference Manual</i> .

The interactive Tcl shell for command-line executables is invoked using the `-s` command-line switch. For example, to run the basic Quartus shell, type `quartus_sh -s` at the command prompt:

```
% quartus_sh -s
Info:
*****
Info: Running Quartus II Shell
Info:
*****
Info: The Quartus II Shell supports all TCL commands in addition
Info: to Quartus II Tcl commands. All unrecognized commands are
Info: assumed to be external and are run using Tcl's "exec"
Info: command.
Info: - Type "exit" to exit.
Info: - Type "help" to view a list of Quartus II Tcl packages.
Info: - Type "help -pkg <package name>" to view a list of Tcl commands
Info: available for the specified Quartus II Tcl package.
Info: - Type "help -tcl" to get an overview on Quartus II Tcl usages.
Info:
*****
tcl>
```

The Quartus II Tcl implementation provides custom Tcl procedures to perform Quartus II operations. These procedures are organized into Tcl packages based on their functionality. Table 6–2 lists these Tcl packages and their availability. Some packages are loaded by default when the executable is invoked. Others must be explicitly loaded before their Tcl procedures are used. To load a particular package, use the `load_package` Tcl procedure. For example, to load the flow package in the `quartus_sh` shell, the following Tcl statement is executed:

```
tcl> load_package flow
```



It is important to note that not all executables support all Tcl packages.

Executable Name	Supported Tcl Package	Loaded by Default?
quartus_sta	device	Loaded
	misc	Loaded
	flow	Not loaded
	project	Loaded
	report	Loaded
	sdh	Loaded
	sta	Loaded

Table 6–2. Tcl Package Support in Quartus II Executables (Part 2 of 2)

Executable Name	Supported Tcl Package	Loaded by Default?
quartus_sh	device	Loaded
	flow	Not Loaded
	misc	Loaded
	project	Loaded
	report	Not Loaded
quartus_tan	advanced_timing	Not Loaded
	device	Not Loaded
	flow	Not Loaded
	logiclock	Not Loaded
	Misc	Loaded
	project	Loaded
	report	Not Loaded
	timing	Loaded
timing_report	Not Loaded	
quartus_cdb	backannotate	Not Loaded
	chip_editor	Not Loaded
	device	Loaded
	flow	Not Loaded
	logiclock	Not Loaded
	misc	Loaded
	project	Loaded
	report	Not Loaded
quartus_sim	device	Loaded
	flow	Not Loaded
	misc	Loaded
	project	Loaded
	report	Loaded
	simulator	Loaded

A brief description of each of the Tcl packages referenced in [Table 6–2](#) is given in [Table 6–3](#).



To find out which Tcl packages are loaded, use the command `quartus_??? --tcl_eval help`. For example:
`quartus_sta --tcl_eval help`.

Table 6–3. Quartus II Tcl Package Descriptions

Tcl Package	Description
advanced_timing	Traverse the timing netlist and get information about timing modes.
backannotate	Back annotate assignments.
chip_editor	Identify and modify resource usage and routing with the Chip Editor.
database_manager	Manage version-comparable database files.
device	Get device and family information from the device database.
flow	Compile a project, run command-line executables and other common flows.
logiclock	Create and manage LogicLock regions.
misc	Perform miscellaneous tasks.
project	Create and manage projects and revisions and make any project assignments including timing assignments.
report	Get information from report tables and create custom reports.
simulator	Configure and perform simulations.
stp	Operate the SignalTap® II Analyzer.
timing	Annotate timing netlist with delay information, compute and report timing paths.
timing_report	List timing paths.

The Quartus II command-line executables and Tcl shells are supported on all Quartus II operating systems, including Microsoft Windows, Linux, and Unix platforms.



For more information on Quartus II Tcl packages and their available Tcl procedures, refer to the *Tcl Packages and Commands* chapter in the *Quartus II Scripting Reference Manual*.

Command-Line Processing

In addition to the interactive Tcl shell, the Quartus II command-line executables support command-line switches for executing Tcl scripts and commands. When used with these switches, a command-line executable quits when complete. The command-line executables also provide switches for performing specific Quartus II operations. For example, the following c-shell script takes as its argument the top-level design file and entity name and runs it through the entire HardCopy II design flow.

```
#!/bin/csh
quartus_sh --flow compile %1
quartus_cdb %1 --create_companion=%1_hcii
quartus_sh --flow compile %1 -c %1_hcii
quartus_cdb --compare=%1_hcii %1 -c %1
```

This example shows what is, perhaps, the simplest way to execute the HardCopy II design flow. If you have developed and applied the design I/O, location and timing constraints for the project, these constraints are included during script execution.



For more information on the Quartus II executables and command-line options, refer to the *Command-Line Executables* chapter in the *Quartus II Scripting Reference Manual* and the *Command-Line Scripting* section in volume 2 of the *Quartus II Handbook*.

The HardCopy II Design Flow

The Quartus II software supports both HardCopy II first and Stratix II first design flows. The Stratix II first flow involves the following:

- Compiling for the Stratix II FPGA prototype
- Verifying the Stratix II FPGA prototype
- Migrating the prototype design to a HardCopy II design
- Compiling the HardCopy II design
- Transferring your HardCopy II files to the Altera® Design Center

The Hardcopy II first flow is similar, but starts with compiling the HardCopy II target device. Once the HardCopy II compile completes successfully, the design is migrated to the Stratix II target.

The HardCopy II design flow in the Quartus II software is shown in [Figure 6-1](#). To begin a design, create a new project and revision for the Stratix II FPGA prototype. Apply Quartus II settings together with I/O assignments and timing constraints. Compile the Stratix II prototype revision (synthesis, place and route, and assembly) to produce a complete layout, with timing closure and free from errors. You can now perform any additional functional and timing verification necessary and then implement and verify the prototype in hardware.

Once the FPGA prototype is verified, you can compile the HardCopy II design. Begin by creating a HardCopy II companion revision for the FPGA prototype:

1. Create a HardCopy II companion revision for the FPGA prototype. All design settings and constraints are automatically migrated to the new companion revision.
2. Compile the HardCopy II revision. As the compile runs, the Design Assistant checks for errors. When the compile completes, you should correct errors and resolve failures that appear in the Quartus II reports.

3. Run the HardCopy II Companion Revision Comparison tool to compare the HardCopy II design against the FPGA prototype. The comparison tool checks for structural equivalency and consistency between the two revisions.
4. If there are no mismatches, you can prepare the HardCopy II design files for transfer to the Altera Design Center.



In addition to design verification in the Quartus II software, the flow can generate files required to perform Static Timing Analysis (STA) in Synopsys' Primetime.

Figure 6–1. The HardCopy II Design Flow

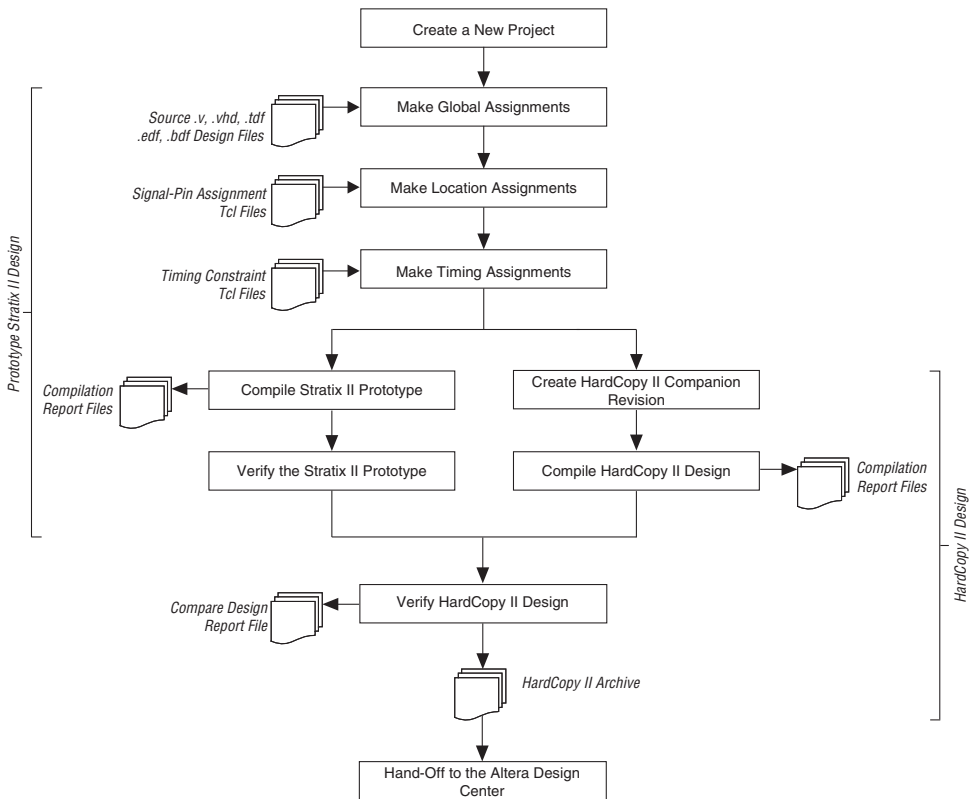

The design flow of [Figure 6-1](#) begins with a Stratix II FPGA prototype design and migrates this design to a HardCopy II device target, or begins with a HardCopy II target and migrates this design to a Stratix II target for FPGA prototyping. The design flow for both cases is shown in [Figure 6-1](#).



For more information on the HardCopy II design flow and alternative methods to complete HardCopy II designs using the Quartus II GUI, refer to the *Quartus II Support for HardCopy II Devices* chapter in the *Quartus II Handbook* or the *HardCopy II Design Considerations* chapter in volume 1 of the *HardCopy Series Handbook*.

The following sections describe each step of the flow shown in [Figure 6-1](#) and explains how each step is completed using the interactive Tcl shell.

Creating a New Project

Both FPGA and HardCopy design in the Quartus II software revolve around the use of projects. You must create a project before you begin working with a new design. A project includes source design files (RTL and schematics), Quartus II tool settings, and a set of pin locations and timing constraints. Although a project can contain many different revisions for a design, each revision can have a unique set of design constraints, target device settings, and Quartus II software settings. You must explicitly open a project before you can perform other operations on the project. You must close the current project to switch to a different project or revision.

This section details the different operations relating to project management using Tcl commands.

Creating a Stratix II Prototype Project

To create a new Stratix II prototype project, use the **project_new** Tcl command. The syntax for this command is:

```
tcl> project_new [-family <family>] [-overwrite] \  
    [-part <part>] [-revision <revision_name>] \  
    <project_name>
```

The only required argument for this command is the project name, *<project name>*, although the target device family, part code, and revision name can be specified at this time also. By default, the revision name is the same as the project name. The device family and part code can be set later using the **set_global_assignment** command. For example, to create

a project called `demo_design` with the default revision name of `demo_design` and an unspecified target device family or part, the following Tcl command is executed:

```
tcl> project_new demo_design
```

Creating a new project creates a Quartus settings file (QSF) and a Quartus II Project file (QPF) in the current directory. In addition, a `db` subdirectory is created that is used to store Quartus II database files. In the case of the `demo_design` project example, the following files are created in the project directory:

```
demo_design.qpf
demo_design.qsf
db/
  demo_design.db_info
```

Opening a Project

The project created automatically opens when you use the **project_new** command. In future Quartus II sessions, or if you close the project, you must open the project with the Tcl command: **project_open**. The syntax for the **project_open** command is:

```
tcl> project_open [-current_revision] \
  [-revision <revision_name>] <project_name>
```

For example, to open the default revision of project `demo_design`, execute the following Tcl command:

```
tcl> project_open demo_design
```



It is a good practice to have consistent names for the Stratix II and HardCopy II revisions of your project. This makes it easy to identify which revision is which. For example, naming your revisions `projectname_fpga` and `projectname_hcii` would help you easily identify which revision is the Stratix II revision, and which is the HardCopy II revision.

Closing a Project

Before ending a Quartus II project session, it is good practice to close the Quartus II project using the **project_close** command. This ensures that any changes you have made to your project are written to the Quartus II QSF file. The syntax for the **project_close** command is:

```
tcl> project_close [-dont_export_assignments]
```

New Project Example Script

The following script shows the use of Tcl commands for opening and closing a project called `demo_design` with the revision name, `demo_design_fpga`. If the project does not already exist, it is created. This script makes use of the `project_exists` and `project_open` Tcl commands.

```
## Example Tcl Script for opening and closing a project

## Open Project demo_design.  If the Project does not Already
## Exist, Create it
if [is_project_open] project_close
if [project_exists demo_design] {
    project_open demo_design -revision demo_design_fpga
} else {
    project_new demo_design -revision demo_design_fpga
}

## Include Other Tcl Commands Here ...

## Close project demo_design and write any changes to settings to
## demo_design.qsf
project_close

## End of script
```



For more information on these and other useful project-related commands, refer to the *Project* section in the *Tcl Packages and Commands* chapter in the *Quartus II Scripting Reference Manual*.

Making Global Assignments

Initializing a HardCopy II Design

For a HardCopy II design, the following key operations are required after a Quartus II project is created:

- Specify design source files (Verilog, VHDL, AHDL, EDIF, and BDF files)
- Specify the Stratix II prototype target family and device name
- Specify the HardCopy II companion revision and migration device
- Enable the Design Assistant
- Make recommended HardCopy II specific Quartus II tool settings

In addition to these, other project settings affecting downstream tools, such as synthesis and place-and-route, can be made at this time.

The operations listed above are performed using the **set_global_assignment** command. The syntax for this command is:

```
tcl> set_global_assignment [-comment<comment>] \  
    [-disable] [-entity <entity_name>] -name <name> \  
    [-remove] [-section_id <section_id>] <value>
```

The most important parameters for the **set_global_assignment** command are *<name>* and *<value>*. The *<name>* argument specifies the Quartus II global variable to be set and *<value>* is the new value assigned to that variable.

One of the steps in initializing a HardCopy II design is to turn on the Design Assistant. When run in the GUI, the Design Assistant provides a visual checklist for running both the Stratix II and HardCopy II phases of the design. For first-time users, this can provide a powerful guide for successfully completing your HardCopy II project.

The key global variables for a HardCopy II project are listed in [Table 6–4](#).

Table 6–4. Key HardCopy II Design Settings	
Global Variable Name <name>	Value Description <value>
VERILOG_FILE	Verilog file name.
VHDL_FILE	VHDL file name.
AHDL_FILE	Altera HDL file name.
EDIF_FILE	EDIF file name.
BDF_FILE	Altera schematic file name.
FAMILY	Device family name, for example, Stratix II.
DEVICE	Prototype FPGA target device name.
TOP_LEVEL_ENTITY	Top-level design entity or module name.
DEVICE_TECHNOLOGY_MIGRATION_LIST	HardCopy II target device name.
COMPANION_REVISION	HardCopy II design revision name.
ENABLE_DRC_SETTINGS	Turn on the Design Assistant.
USE_TIMEQUEST_TIMING_ANALYZER	Set TimeQuest as the default timing analyzer <ON>.
SDC_FILE	File of TimeQuest constraints <constraint_file.sdc>.
You only need the following settings when using Classic Timing Analyzer. Using Classic Timing Analyzer is not recommended.	
REPORT_IO_PATHS_SEPARATELY	Creates a separate report panel for input and output min and max timing results.
FLOW_ENABLE_TIMING_CONSTRAINT_CHECK	Timing constraints are checked for completeness (all clock domains constraints and minimum and maximum constraints are set for all I/O paths).
DO_COMBINED_ANALYSIS	Timing analysis are run for fast and slow operating conditions and for best and worst-case timing analysis, respectively.
IGNORE_CLOCK_SETTINGS	This must be turned off.
ENABLE_RECOVERY_REMOVAL_ANALYSIS	Verify recovery and removal times on asynchronous control and reset signals.
ENABLE_CLOCK_LATENCY	Clock latency is included in timing analysis to assess clock-insertion timing and clock skew.

The `DEVICE` and `DEVICE_TECHNOLOGY_MIGRATION_LIST` variables are the parts used for the Stratix II prototype design and the HardCopy II design. The selected Stratix II prototype device must be compatible with the selected HardCopy II device to make migration possible. Valid pairings for these devices are listed in [Table 6-5](#).

For the `DEVICE_TECHNOLOGY_MIGRATION_LIST` variable, the HardCopy II part names listed in [Table 6-5](#) are used. For the `DEVICE` variables, the Stratix II part names include the speed grade for the part. The speed grade is a two character code indicating industrial (I) or commercial (C) and the speed indicator (number 3, 4, or 5). For example, a -4 commercial part is denoted using the two character speed grade C4. The two-character speed grade is appended to the Stratix II part name to form the value string for the `DEVICE` variable.

Table 6-5. Stratix II Prototype Options for HardCopy II (Part 1 of 2)

HardCopy II Part	Stratix II Prototype Part
HC210F484C HC210W484C	EP2S30F484C3 EP2S30F484C4 EP2S30F484C5 EP2S30F484I4
	EP2S60F484C3 EP2S60F484C4 EP2S60F484C5 EP2S60F484I4
	EP2S90H484C4 EP2S90H484C5
HC220F672C	EP2S60F672C3 EP2S60F672C4 EP2S60F672C5 EP2S60F672I4
HC220F780C	EP2S90F780C4 EP2S90F780C5
	EP2S130F780C4 EP2S130F780C5

Table 6-5. Stratix II Prototype Options for HardCopy II (Part 2 of 2)

HardCopy II Part	Stratix II Prototype Part
HC230F1020C	EP2S90F1020C3 EP2S90F1020C4 EP2S90F1020C5 EP2S90F1020I4
	EP2S130F1020C3 EP2S130F1020C4 EP2S130F1020C5 EP2S130F1020I4
	EP2S180F1020C3 EP2S180F1020C4 EP2S180F1020C5 EP2S180F1020I4
HC240I020C	EP2S180F1020C3 EP2S180F1020C4 EP2S180F1020C5 EP2S180F1020I4
HC240F1508C	EP2S180F1508C3 EP2S180F1508C4 EP2S180F1508C5 EP2S180F1508I4

The following two Tcl commands demonstrate setting the DEVICE and DEVICE_TECHNOLOGY_MIGRATION_LIST variables.

```
tcl> set_global_assignment -name DEVICE EP2S90F1020C4
tcl> set_global_assignment -name \
    DEVICE_TECHNOLOGY_MIGRATION_LIST HC230F1020C
```

The Design Assistant

You should turn on the Design Assistant at the beginning of the design process by turning on the `ENABLE_DRC_SETTINGS` global variable.

```
tcl> set_global_assignment \  
      -name ENABLE_DRC_SETTINGS ON
```

The Design Assistant runs concurrently with every step of both the prototype Stratix II and HardCopy II design flows. When the Design Assistant is turned on, the Quartus II software checks to ensure that the project fully complies with all HardCopy II design rules and requirements.



For more information on the Design Assistant, refer to the *Design Guidelines for HardCopy II Devices* chapter in volume 1 of the *HardCopy Series Handbook* and the *Quartus Support for HardCopy II Devices* chapter in the *Quartus II Handbook*.

Example Tcl Script for Making Global Assignments

The example Tcl script below illustrates the application of global constraints for a HardCopy II project.

```
## Example Global Assignments Script for a HardCopy II Design
## This Script Applies Settings for a EP2S90 Stratix II
## prototype FPGA target and a HC230 HardCopy II target

## Source Design File Settings
## =====
set_global_assignment -name VERILOG_FILE demo_design.v
set_global_assignment -name VERILOG_FILE example_ram.v

## Stratix II Prototype FPGA Target Settings
## =====
set_global_assignment -name FAMILY "Stratix II"
set_global_assignment -name DEVICE EP2S90F1020C4
set_global_assignment -name TOP_LEVEL_ENTITY demo_design

## HardCopy II Companion Revision and Target Settings
## =====
set_global_assignment -name COMPANION_REVISION_NAME \
                      demo_design_hardcopyii
set_global_assignment -name DEVICE_TECHNOLOGY_MIGRATION_LIST HC230F1020

## Design Assistant Assignments and Settings Required for HardCopy II
## =====
set_global_assignment -name ENABLE_DRC_SETTINGS ON
set_global_assignment -name ERROR_CHECK_FREQUENCY_DIVISOR 1
set_global_assignment -name REPORT_IO_PATHS_SEPARATELY ON

## The following assignments are Classic Timing Analyzer only
## and are not used by TimeQuest.
## =====
set_global_assignment -name FLOW_ENABLE_TIMING_CONSTRAINT_CHECK ON
set_global_assignment -name DO_COMBINED_ANALYSIS ON
set_global_assignment -name IGNORE_CLOCK_SETTINGS OFF

set_global_assignment -name ENABLE_RECOVERY_REMOVAL_ANALYSIS ON
set_global_assignment -name ENABLE_CLOCK_LATENCY ON

## End of Script
```

Making I/O Assignments

Because of the complex rules governing the use of programmable I/O cells and their availability for specific pins and packages, Altera highly recommends that I/O assignments are completed using the Pin Planning tool and the Assignment Editor in the Quartus II GUI. These tools ensure that all of the rules regarding each pin and I/O cell are applied correctly. The Quartus II GUI can export a Tcl script containing all I/O assignments and specifications. I/O assignments are described here for information only.



For more information on I/O location and type assignments using the Quartus II Assignment Editor and Pin Planner tools, refer to the *Assignment Editor* chapter in volume 2 of the *Quartus II Handbook*.

In this section, I/O specification is considered in two parts:

- Pin assignments
- I/O type assignments

Pin Assignments

Design I/O signals are assigned to package balls using the **set_location_assignment** command. The syntax for this command is given below:

```
tcl> set_location_assignment [-comment <comment>] \
    [-disable] [-remove] -to <destination> <value>
```

Here, *<destination>* is the package ball name and *<value>* is the design I/O signal name. For BGA and FBGA packages, the ball name follows the form PIN_*<coordinate>*. For example, to assign design I/O signal data_out[15] to package ball AL17:

```
tcl> set_location_assignment -to PIN_AL17 data_out[15]
```

Setting I/O Type and Parameters

For I/O type and parameter specification, the **set_instance_assignment** command is used. The syntax for this command is:

```
tcl> set_instance_assignment [-comment <comment>] \
    [-disable] [-entity <entity_name>] \
    [-from <source>] -name <name> [-remove] \
    [-section_id <section_id>] \
    [-to <destination>] <value>
```

The assignment name, *<name>*, should be set to `IO_STANDARD` to indicate that an I/O specification is being applied. The related I/O signal is specified as `-to <destination>`. The destination argument is a string providing details on the I/O type, such as levels and standards. Table 6–6 lists the strings corresponding to the I/O standards supported in HardCopy II devices.

I/O Type or <name>	Description
LVTTL	LVTTL I/O
LVC MOS	LVC MOS I/O
“3.3-V PCI”	3.3-V PCI I/O
“3.3-V PCI-X”	3.3-V PCI X I/O
“1.5 V”	1.5-V I/O
“1.8 V”	1.8-V I/O
“2.5 V”	2.5-V I/O
“1.5-V HSTL CLASS I”	QDR II SRAM 1.5-V I/O
“1.5-V HSTL CLASS II”	QDR II SRAM 1.5-V I/O
“1.8-V HSTL CLASS I”	QDR II SRAM/RLDRAM II 1.8-V I/O
“1.8-V HSTL CLASS II”	QDR II SRAM/RLDRAM II 1.8-V I/O
“DIFFERENTIAL 1.5-V HSTL CLASS I”	Memory clock interface
“DIFFERENTIAL 1.5-V HSTL CLASS II”	Memory clock interface
“DIFFERENTIAL 1.8-V HSTL CLASS I”	Memory clock interface
“DIFFERENTIAL 1.8-V HSTL CLASS II”	Memory clock interface
“DIFFERENTIAL 1.8-V SSTL CLASS I”	DDR2 SDRAM
“DIFFERENTIAL 1.8-V SSTL CLASS II”	DDR2 SDRAM
“DIFFERENTIAL SSTL-2”	DDR SDRAM
“DIFFERENTIAL 2.5-V SSTL CLASS II”	DDR SDRAM
“SSTL-18 CLASS I”	DDR2 SDRAM
“SSTL-18 CLASS II”	DDR2 SDRAM
“SSTL-2 CLASS I”	DDR SDRAM
“SSTL-2 CLASS II”	DDR SDRAM
LVDS	2.5-V differential signaling
HYPERTRANSPORT	2.5-V differential signaling
LVPCL	Differential

You can specify a number of other I/O parameters by using the **set_instance_assignment** command. Some of the more common parameters are listed in [Table 6-7](#).

<name> setting	<value> setting	Description
<code>weak_pull_up_resistor</code>	on	Implement a weak pull-up resistor on the pin.
<code>output_pin_load</code>	integer	Capacitive load for an output or bidirectional pin. Units of pF.
<code>fast_output_register</code>	on	Implements a fast output register in the I/O cell or adjacent LAB.
<code>fast_output_enable_register</code>	on	Implement a fast output enable register in the I/O cell or/and adjacent LAB.
<code>fast_input_register</code>	on	Implements a fast input register in the I/O cell or adjacent LAB.
<code>current_strength_new</code>	2 mA, 4 mA, 8 mA, 10 mA, 12 mA, 16 mA, 18 mA, 20 mA, 24 mA minimum_current or maximum_current	Drive strength for an output or bidi pin.
<code>stratixii_termination</code>	differential "series 25 ohms with calibration" "series 25 ohms without calibration" "series 50 ohms with calibration" "series 50 ohms without calibration"	On-chip termination (or impedance matching) for an I/O pin.



For more information on I/O availability in HardCopy II devices, refer to the *I/O Structures and Features* section in volume 1 of the *HardCopy Series Handbook*.

I/O Assignment Example Script

The following Tcl script example specifies several different I/O constraints.

```
## Signal-Ball Assignments
set_location_assignment PIN_AH5 -to addr_out[0]
set_location_assignment PIN_AH6 -to addr_out[1]
set_location_assignment PIN_AJ5 -to data_in[0]
set_location_assignment PIN_AJ6 -to data_in[1]
set_location_assignment PIN_AJ32 -to resetn
set_location_assignment PIN_AM17 -to ref_clk

# I/O Type and Parameter Assignments
set_instance_assignment -name IO_STANDARD "1.5-V HSTL CLASS II" -to addr_out[0]
set_instance_assignment -name IO_STANDARD "1.5-V HSTL CLASS II" -to addr_out[1]
set_instance_assignment -name IO_STANDARD "1.5-V HSTL CLASS II" -to data_in[0]
set_instance_assignment -name IO_STANDARD "1.5-V HSTL CLASS II" -to data_in[1]
set_instance_assignment -name IO_STANDARD LVDS -to resetn
set_instance_assignment -name IO_STANDARD LVCMOS -to ref_clk

set_instance_assignment -name fast_input_register on -to data_in[0]
set_instance_assignment -name fast_input_register on -to data_in[1]
set_instance_assignment -name fast_output_register on -to addr_out[0]
set_instance_assignment -name fast_output_register on -to addr_out[1]

set_instance_assignment -name output_pin_load 10 -to addr_out[0]
set_instance_assignment -name output_pin_load 10 -to addr_out[1]
set_instance_assignment -name current_strength_new 16mA -to addr_out[0]
set_instance_assignment -name stratixii_termination "series 25 ohms without calibration"
-to data_in[1]
```

Assigning Timing Constraints

Planning Design Timing Constraints

Timing constraints ensure that a design compiled in the Quartus II software meets specific timing requirements. When you target an FPGA, you may decide not to apply a complete set of timing constraints, choosing instead to fix any timing problems in your prototype system if and when they arise. HardCopy devices, however, cannot be modified using reconfiguration to fix timing problems, so it is critically important that a design is fully constrained. Designs not fully constrained would result in significantly different timing characteristics between the prototype Stratix II FPGA and the HardCopy II device. By fully constraining a design, Altera can guarantee that both the Stratix II FPGA and the HardCopy II device fully complies with your timing specifications.

The minimum set of timing constraints for a HardCopy II design are:

- Clock settings (F_{MAX}) for each and every clock domain
- Minimum and maximum delays for all I/O paths, including asynchronous reset and control I/O signals

In addition, it is good design practice to develop timing constraints to cover:

- Specific cross-clock domain timing requirements
- False paths
- Multicycle paths

In TimeQuest, timing constraints are written in TimeQuest SDC format and are read from an SDC file. An example file is *demo_design.sdc*. See [“Using TimeQuest” on page 6–30](#).

In the Classic Timing Analyzer, timing constraints are applied using dedicated Tcl commands and by assigning timing-specific attributes using the **set_instance_assignment** command.

This section provides an overview of timing constraint development using Tcl commands.



For more information on timing constraints, refer to the *Timing Analysis* section in volume 3 of the *Quartus II Handbook*.

Specifying System Clocks

The most basic constraints that should be applied describe the clock for each clock domain. Parameters usually specified for each clock are:

- Clock period
- Latency (LATE_CLOCK_LATENCY/EARLY_CLOCK_LATENCY assignments)
- Uncertainty (**set_clock_uncertainty** command)

Clock uncertainty specified with the **set_clock_uncertainty** command models any uncertainty in the clock period, including jitter, and is often used to introduce some margin into the target clock frequency. The following example constraints illustrate clock definition for a design with two clock domains, `clk_a` and `clk_b`. In this case, both clocks run at 100 MHz, but with different clock latency and skew.

```
## Example TimeQuest SDC Constraints Defining Clocks clk_a and clk_b
create_clock -period 10.0 -name clk_a [get_ports clk_a]
set_clock_latency -source -late 3.0 clk_a
set_clock_latency -source -early 2.0 clk_a
```

```
set_clock_uncertainty -to clk_a 0.25

create_clock -period 10.0 -name clk_b [get_ports clk_b]
set_clock_latency -source -late 4.0 clk_b
set_clock_latency -source -early 3.0 clk_b
set_clock_uncertainty -to clk_b 0.25
```

Input/Output Timing

System clock parameters define the setup and hold timing for register to register paths within each clock domain. I/O timing parameters are used to describe I/O to register, and register to I/O timing.

The **set_input_delay** constraint is used to specify the delay from a source external to the chip to an input pin, relative to a defined clock. The syntax for this command is given below.

```
set_input_delay \  
  -clock <clock name> \  
  [-clock_fall] \  
  [-rise | -fall] \  
  [-max | -min] \  
  [-add_delay] \  
  [-reference_pin <pin or port>] \  
  <delay value> \  
  <port pin list>
```

The *<clock name>* argument specifies the reference clock for the delay. The *<port pin list>* argument is the top-level input signal for the design, and *<delay value>* is the external delay. The external delay is measured from the positive (rising) edge of *<clock>* unless the `-clock_fall` argument is specified. The `-min` and `-max` arguments are used to specify whether *<delay value>* is the minimum or maximum external delay, respectively.

The **set_output_delay** constraint is similar to the **set_input_delay** constraint except that it specifies the delay from an output pin to its external destination relative to a clock.

```
set_output_delay \  
  -clock <clock name> \  
  [-clock_fall] \  
  [-rise | -fall] \  
  [-max | -min] \  
  [-add_delay] \  
  [-reference_pin <pin or port>] \  
  <delay value> \  
  <port pin list>
```

As an example, the following Tcl script specifies input and output min and max delays for two I/O signals. Input `data_in[0]` has minimum and maximum external delays of 3 ns and 7 ns, respectively. Output `data_out[0]` has minimum and maximum external delays of 4 ns and 8 ns, respectively. The external input delays for `data_in[0]` are relative to the positive edge of clock `ref_clk` and the external output delays for `data_out[0]` are relative to the negative edge of clock `ref_clk`.

```
# Tcl Script Setting I/O Timing Using set_input_delay and set_output_delay
set_input_delay -clock ref_clk -max 7.0 [get_ports data_in[0]]
set_input_delay -clock ref_clk -min 3.0 [get_ports data_in[0]]
set_output_delay -clock ref_clk -max 8.0 [get_ports data_out[0]]
set_output_delay -clock ref_clk -min 4.0 [get_ports data_out[0]]
```

Creating Timing Exceptions

Timing exceptions are used to correct timing constraints not covered by clock settings and I/O timing settings. The most common of these are multicycle paths and false paths.

In TimeQuest, multicycle paths are described using the **set_multicycle_path** constraint. The syntax for this constraint is:

```
set_multicycle_path [-setup] [-hold] [-start]
```

In Classic Timing Analyzer, multicycle paths are described using the **set_multicycle_assignment** command. The syntax for this command is:

```
tcl> set_multicycle_assignment [-comment <comment>] \
    [-disable] [-end] [-from <from_list>] \
    [-hold] [-remove] [-setup] [-start] \
    [-to <to_list>] <path_multiplier>
```

In either timing analyzer, multicycle assignments are made with the `-setup` argument, to specify the maximum number of cycles, or with the `-hold` argument, to specify the minimum number of cycles for a path.

False paths describe paths that should not be included in timing optimization or analysis operations. In the Quartus II software, there are a number of ways to describe false paths. By default, in Classic Timing Analyzer, feedback from the output to input side of bidirectional I/O, read-while-write paths through memories, and cross-clock domain paths are not timed during optimization or timing analysis. By default, in Time Quest, cross-clock domain paths are timed.



To change these default settings, refer to the *Timing Settings* section in the *Quartus II Support of HardCopy Series Devices* chapter in volume 1 of the *Quartus II Handbook*.

In TimeQuest, the constraint **set_false_path** is used to describe paths that should not be included in timing optimization or analysis. The syntax for this constraint is:

```
tcl> set_false_path \  
    [-from <from list>] \  
    [-to <to list>] \  
    [-thru <thru list>]
```

In Classic Timing Analyzer, the most common command for controlling false paths is the **set_timing_cut_assignment** command. The syntax for this command is:

```
tcl> set_timing_cut_assignment \  
    [-comment <comment>] \  
    [-disable] \  
    [-from <from_pin_list>] \  
    [-remove] \  
    [-to <to_pin_list>]
```

All paths between nodes in the *<from_pin_list>* to nodes in the *<to_pin_list>* are excluded from timing optimization and analysis operations.

Example of TimeQuest SDC Constraints

```
# Timing Assignments  
# =====  
create_clock -period 10.0ns -name ref_clk ref_clk  
  
set_clock_latency -late 3 ref_clk  
set_clock_latency -early 2 ref_clk  
set_clock_uncertainty -hold -to ref_clk 0.250ns  
set_clock_uncertainty -setup -to ref_clk 0.250ns  
  
# Input delay of 6ns (max) & 2ns (min) for bus data_in[1:0]  
set_input_delay -clock ref_clk -max 6 data_in  
set_input_delay -clock ref_clk -min 2 data_in  
  
# Output delay of 6ns (max) & 2ns (min) for bus data_out[1:0]  
set_output_delay -clock ref_clk -max 6 data_out  
set_output_delay -clock ref_clk -min 2 data_out  
  
# Don't care about timing on the resetn net. Set as false path  
set_false_path -from resetn
```

Example of Classic Timing Analyzer Tcl Script

```
# Timing Assignments
# =====
create_base_clock -fmax 100 MHz -target ref_clk ref_clk

set_instance_assignment -name LATE_CLOCK_LATENCY 3ns -to ref_clk
set_instance_assignment -name EARLY_CLOCK_LATENCY 2ns -to ref_clk
set_clock_uncertainty -hold -to ref_clk 0.250ns
set_clock_uncertainty -setup -to ref_clk 0.250ns

# Input delay of 6ns (max) & 2ns (min) for bus data_in[1:0]
set_input_delay -clk_ref ref_clk -max -to data_in 6.0ns
set_input_delay -clk_ref ref_clk -min -to data_in 2.0ns

# Output delay of 6ns (max) & 2ns (min) for bus data_out[1:0]
set_output_delay -clk_ref ref_clk -max -to data_out 6.0ns
set_output_delay -clk_ref ref_clk -min -to data_out 2.0ns

# Don't care about timing on the resetn net. Set as false path
set_timing_cut_assignment -from resetn
```

This section has provided an overview of Tcl commands for applying timing constraints.



For more information on the application of timing constraints using Tcl commands, refer to the *Tcl Packages and Commands* chapter in the *Quartus II Scripting Reference Manual*.

Compiling the Stratix II Prototype Design

Once all global assignments, resource assignments, and timing assignments have been specified, the next step in the design process is to compile the Stratix II FPGA prototype design. The `execute_flow` command is provided for this purpose and supports various arguments affecting the compilation process. The syntax for this command is:

```
tcl> execute_flow \
    [-analysis_and_elaboration] \
    [-attempt_similar_placement] \
    [-check_ios] \
    [-check_netlist] \
    [-compile] \
    [-compile_and_simulate] \
    [-early_timing_estimate] \
    [-eco] [-export_database] \
    [-fast_model] \
    [-generate_functional_sim_netlist] \
    [-import_database]
```

The switches relevant to prototype Stratix II and HardCopy II design are listed in [Table 6–8](#).

Switch	Description
analysis_and_elaboration	Perform synthesis and mapping to the target Altera technology
attempt_similar_placement	Runs Attempt Similar Placement
check_ios	Verify I/O assignments
check_netlist	Perform syntax checks on the netlist
compile	Execute the Quartus II compilation flow
compile_and_simulate	As for compile, but also run simulation
early_timing_estimate	Runs the early timing estimator
eco	Executes a Fitter ECO compilation
export_database	Exports a Version-Compatible Database
fast_model	Runs Timing Analysis (fast mode analysis)
generate_functional_sim_netlist	Generate a Simulation Netlist
import_database	Imports a Version-Compatible Database



It is important to note that the HardCopy switches for the `execute_flow` command are for HardCopy Stratix designs, not HardCopy II designs.

The simplest way to run the `execute_flow` command is to use the `-compile` switch.

```
tcl> execute_flow -compile
```

Running the **execute_flow** command in this way executes the four stages of the Quartus II compilation flow with default settings for each stage:

- Analysis and Synthesis
- Fitter
- Timing Analysis
- Assembler

The Design Assistant and Timing constraint checks are run if they are enabled in the Quartus II Settings file.

You should check I/O assignments to avoid problems in downstream compile operations. To do this, the `execute_flow` compilation is broken into three steps:

1. `tcl> execute_flow -analysis_and_elaboration`
2. `tcl> execute_flow -check_ios`
3. `tcl> execute_flow -compile`

It should be noted that, in the interests of clarity and brevity, the Tcl fragments given here do not incorporate any error checking. However, it is good practice to include code in your Tcl scripts that checks for success as your design proceeds. In the case of the `execute_flow` procedure, the return value can be used with the Tcl `catch` command to handle success or failure. The example below shows one option for doing this.

```
# Determine if compilation was successful and
# print out a personalized message.
if {[catch {execute_flow -compile} result]} {
    puts "\nResult: $result\n"
    puts
    "ERROR: Compilation failed. See report files.\n"
} else {
    puts "\nINFO: Compilation was successful.\n"
}
```



For more information on the `execute_flow` command, refer to the command description in the *Tcl Packages and Commands* chapter in the *Quartus II Scripting Reference Manual*.

Compiling the HardCopy II Design

Once the Stratix II FPGA prototype design is compiled and verified, you can compile the HardCopy II revision of the design. This is a two-step process:

1. Create the HardCopy II companion revision.
2. Compile the HardCopy II companion revision.

To create the HardCopy II version of the design, run the `execute_hardcopyii` Tcl command with the `-create_companion` option:

```
tcl> execute_hardcopyii -create_companion demo_design_hcii
```

This command initializes the database for the HardCopy II revision and creates a new QSF file (in this example, **demo_design_hcii.qsf**), ensuring that all constraints for the Stratix II FPGA revision are ported over.

Next, the current working revision for the Quartus II project is changed to the HardCopy II revision and the design is compiled for the HardCopy II device target:

```
tcl> set_current_revision demo_design_hcii
tcl> execute_flow -compile
```

As with the prototype Stratix II revision, report files are generated in the project directory for each of the tools that are executed.

Understanding Report Files

The **execute_flow** command generates a number of report files in the project directory. These files summarize messages displayed on the console during compilation and provide additional information about the design. The name of each report file follows the format *<revision><tool short name>.summary* and *<revision><tool short name>.rpt*, where *<revision>* is the revision name of the current design. The **.summary** file contains a brief summary of messages and results from the tool while the **.rpt** file contains more detailed messages and information. For a HardCopy II project, two sets of report files are generated: one for the Stratix II prototype FPGA revision and one for the HardCopy II revision. [Table 6–9](#) describes the different report files.

 The Tcl report package provides a powerful collection of procedures for customizing and managing report files related to the Quartus II fitter and timing analysis engines.



For more information on customizing and managing report files, refer to the *Tcl Packages and Commands* report section of the *Quartus II Tcl Reference Manual*.

Table 6–9. Stratix II Compile Report File Descriptions (Part 1 of 2)

Switch	Tool	Description
<i><revision>.map.rpt</i>	Analysis & Synthesis	Synthesis settings, source files, messages, and resource usage.
<i><revision>.map.eqn</i>	Analysis & Synthesis	Implementation equations and device resource instantiations.
<i><revision>.fit.rpt</i>	Fitter	Fitter settings, layout optimizations, resources, pin-out, and messages.
<i><revision>.fit.eqn</i>	Fitter	Implemented equations and device resource instantiations after fitting.
<i><revision>.drc.rpt</i>	Design Assistant	Design rule settings, violations, and messages.

Table 6–9. Stratix II Compile Report File Descriptions (Part 2 of 2)

Switch	Tool	Description
<revision>.upc.rpt	Timing Constraint Checker	Constraint coverage information.
<revision>.asm.rpt	Assembler	Assembler settings, .pof and .sof output file options, and messages.
<revision>.rec.rpt	Companion Revision Comparison	A status report on the structural comparison between the HardCopy II revision and the Stratix II Prototype design.
<revision>.flow.rpt	Flow	Resource summary and execution time for each tool in the flow. This report is updated as different tools in the flow complete.
<revision>.sta.rpt	TimeQuest	TimeQuest timing analysis report.

Comparing FPGA and HardCopy Revisions

Before submitting the HardCopy II project to the Altera Design Center, it should be checked against the Stratix II prototype FPGA revision. To do this, run the `execute_hardcopyii` Tcl command with the `-compare` option from the `quartus_sh` shell:

```
tcl> execute_hardcopyii -compare
```

Running this command generates a report file and summary file in the project directory. These files are called `<revision_name>.rec.rpt` and `<revision_name>.rec.summary`. The command checks to verify that the following items conform to HardCopy II design rules and are consistent between the HardCopy II and Stratix II revisions:

- Source design files and device netlist files
- User clock assignments
- Timing constraints (assignments)
- I/O location and type assignments
- PLL parameters
- Memory implantation parameters
- DSP implementation parameters
- Global resource properties
- Properties of all other device resources used

Any errors or failures in comparison are reported in the `.rec` report files. An example `.rec` file is given below. Note that for this example, the design comparison checks in the HardCopy II Companion Revision Comparison Summary table are all marked passed, indicating that the HardCopy II design in the Quartus II software is finished and ready for hand-off to the back-end engineering team in the Altera Design Center.

You must resolve any failures that show up in the Comparison Summary before you proceed any further with your design.

HardCopy II Companion Revision Comparison report for demo_design_hardcopyii
Wed Sep 20 15:30:07 2006
Version 6.0 Build 202 06/20/2006 Service Pack 1 SJ Full Version

; Table of Contents ;

1. Legal Notice
2. HardCopy II Companion Revision Comparison Summary
3. Atom Netlist Comparison Summary
4. DSP Information
5. HardCopy II Companion Revision Comparison Messages

```
+-----+
; HardCopy II Companion Revision Comparison Summary ;
+-----+
; HardCopy II Companion Revision Comparison Status ; Analyzed - Wed Sep 20 15:29:55 2006 ;
; Quartus II Version ; 6.0 Build 202 06/20/2006 SP 1 SJ Full Version ;
; Revision Name demo_dsign_hardcopyii ;
; Top-level Entity Name ; demo_design ;
; Family ; Stratix II ;
; Compare Status ; Passed (14/14) ;
; Source Files Compared ; Passed (121/121) ;
; Assignments Compared ; Passed ;
; User Clocks Compared ; Passed (0/0) ;
; Resource Counts Compared ; Passed (5/5) ;
; I/O Structure Compared ; Passed (130/130) ;
; Package Pins Compared ; Passed (1020/1020) ;
; PLL Structure Compared ; Passed (1/1) ;
; PLL Clocks Compared ; Passed (2/2) ;
; Timing Constraints Compared ; Passed (3/3) ;
; RAM Information Compared ; Passed (10/10) ;
; DSP Information Compared ; Passed (100/100) ;
; Global Resources Compared ; Passed (8/8) ;
; Atom Compared ; Passed (335084/335084) ;
; Atom Netlist Compared ; Passed (1/1) ;
+-----+
```

Performing Static Timing Analysis

Static Timing Analysis in the Quartus II Software

The global assignments made for the Stratix II prototype and HardCopy II revisions ensure that Static Timing Analysis (STA) is run for both fast and slow operating conditions and both setup and hold timing is verified.

Using TimeQuest

You can run the timing analysis independent of the compile process in one of two ways:

1. Use the **execute_module -tool sta** Tcl command to run a timing analysis Tcl script in `quartus_sta` from within the basic quartus shell, `quartus_sh`.

2. Run the `quartus_sta` interactive Tcl shell independently and execute Tcl commands and scripts at the Tcl prompt.

Using Classic Timing Analyzer

You can run the timing analysis independent of the compile process in one of two ways:

1. Use the `execute_module -tool tan` Tcl command to run a timing analysis Tcl script in `quartus_tan` from within the basic quartus shell, `quartus_sh`.
2. Run the `quartus_tan` interactive Tcl shell independently and execute Tcl commands and scripts at the Tcl prompt.



For more information on running static timing analysis in the Quartus II software, refer to the *Timing Analysis* section in the *Quartus II Handbook*.



For Tcl commands related to static timing analysis, refer to the *Timing* section of the *Tcl Packages and Commands* in the *Quartus II Scripting Reference Manual*.

Static Timing Analysis in Primetime

The Quartus II software can also generate files required to run STA in Synopsys' PrimeTime. The following example Tcl commands direct the Quartus II software to generate PrimeTime files for STA.

```
## Tcl Script to Generate PrimeTime STA File Output
execute_module -tool sta -args --tq2pt
execute_module -tool eda -args "--tool primetime --format verilog --timing_analysis"
```

The files generated by the Quartus II software are organized in a subdirectory within the project directory. For example, after compiling a Stratix II prototype design (`demo_design`), the following verilog (`.vo`) SDF (`.sdo`) and PrimeTime Tcl script (`.tcl`) are created in the project directory.

```
timing\
  primetime\
    demo_design_v.sdo
    demo_design.pt.tcl
    demo_design.collections.sdc
    demo_design.constraints.sdc
```

The Tcl script includes all timing constraints applied during the Quartus II software compilation.

HardCopy II Example Tcl Script

The following script draws together the Tcl ideas discussed thus far into a top-level Tcl script for the `quartus_sh` Tcl shell. This script implements a HardCopy II design called `demo_design`. It begins by creating a new project, called `demo_design`, compiling the Stratix II FPGA prototype, creating a HardCopy II companion revision and then compiling the companion revision. Finally, the revision comparison tool is run to verify that both revisions are consistent.

In this example, global, pin, and timing assignment scripts are read into the top-level script using the Tcl **source** command. The sourced scripts are listed after the top-level script listing.

Top-Level Example Script `demo_design.tcl`

```
## demo_design.tcl
## Top-level script for executing a HardCopy II design in quartus_sh -s
load_package flow

## Open of create the Stratix II FPGA prototype revision
if [is_project_open] project_close
if {[project_exists demo_design]} {
    project_open demo_design

} else {
    project_new demo_design
}

## Apply global design settings
source global_assignments.tcl

## Apply I/O assignments
source pin_assignments.tcl

## Apply FPGA timing constraints
source timing_assignments.tcl

## Compile the Stratix II FPGA prototype design
execute_flow -compile

# #Create and switch to the HardCopy II target revision
execute_hardcopyii -create_companion demo_design_hcii
project_close
project_open demo_design -revision demo_design_hcii

## Compile the HardCopy II design revision
execute_flow -compile

## Check the HardCopy II revision and make sure it matches the FPGA
## design
execute_hardcopyii -compare
```

```

## Generate a HardCopy II Handoff Report
execute_hardcopyii -handoff_report

## Archive the HardCopy II Handoff Files into
## the file named "demo_design_hcii_handoff.qar"
execute_hardcopyii -archive demo_design_hcii_handoff.qar

## Quit quartus_sh -s
qexit

## End of demo_design.tcl

```

Global Assignments Script `global_assignments.tcl`

The `global_assignments.tcl` script source in the top-level script, `demo_design.tcl` prepares global variables, target devices, and revision names for the HardCopy II project:

```

## global_assignments.tcl

## Source Design File Settings
## =====
set_global_assignment -name VERILOG_FILE demo_design.v
set_global_assignment -name VERILOG_FILE example_ram.v

## Constraint File Settings for TimeQuest
## =====
set_global_assignment -name USE_TIMEQUEST_TIMING_ANALYZER ON
set_global_assignment -name SDC_FILE demo_design.sdc

## Stratix II Prototype FPGA Target Settings
## =====
set_global_assignment -name FAMILY "Stratix II"
set_global_assignment -name DEVICE EP2S90F1020C4
set_global_assignment -name TOP_LEVEL_ENTITY demo_design

## HardCopy II Companion Revision and Target Settings
## =====
set_global_assignment -name COMPANION_REVISION_NAME \
demo_design_hardcopyii
set_global_assignment -name DEVICE_TECHNOLOGY_MIGRATION_LIST HC230F1020

## Design Assistant Assignments and Settings Required for HardCopy II
## =====
set_global_assignment -name ENABLE_DRC_SETTINGS ON
set_global_assignment -name ERROR_CHECK_FREQUENCY_DIVISOR 1
set_global_assignment -name REPORT_IO_PATHS_SEPARATELY ON

## The following assignments are Classic Timing Analyzer only and
## are not used by TimeQuest.
## =====
set_global_assignment -name FLOW_ENABLE_TIMING_CONSTRAINT_CHECK ON
set_global_assignment -name DO_COMBINED_ANALYSIS ON
set_global_assignment -name IGNORE_CLOCK_SETTINGS OFF

```

```
set_global_assignment -name ENABLE_RECOVERY_REMOVAL_ANALYSIS ON
set_global_assignment -name ENABLE_CLOCK_LATENCY ON
```

```
## End of global_assignments.tcl
```

Pin Assignments Script `pin_assignments.tcl`

The `pin_assignments.tcl` script run from the top-level script, `demo_design.tcl`, specifies top-level design signal to package ball assignments and I/O parameters:

```
## pin_assignments.tcl
set_location_assignment PIN_AH5 -to addr_out[0]
set_location_assignment PIN_AH6 -to addr_out[1]
set_location_assignment PIN_AJ5 -to data_in[0]
set_location_assignment PIN_AJ6 -to data_in[1]
set_location_assignment PIN_AJ32 -to resetn
set_location_assignment PIN_AM17 -to ref_clk

## I/O Type and Parameter Assignments
set_instance_assignment -name IO_STANDARD "1.5-V HSTL CLASS II" -to addr_out[0]
set_instance_assignment -name IO_STANDARD "1.5-V HSTL CLASS II" -to addr_out[1]
set_instance_assignment -name IO_STANDARD "1.5-V HSTL CLASS II" -to data_in[0]
set_instance_assignment -name IO_STANDARD "1.5-V HSTL CLASS II" -to data_in[1]
set_instance_assignment -name IO_STANDARD LVDS -to resetn
set_instance_assignment -name IO_STANDARD LVCMOS -to ref_clk

set_instance_assignment -name fast_input_register on -to data_in[0]
set_instance_assignment -name fast_input_register on -to data_in[1]
set_instance_assignment -name fast_output_register on -to addr_out[0]
set_instance_assignment -name fast_output_register on -to addr_out[1]

set_instance_assignment -name output_pin_load 10 -to addr_out[0]
set_instance_assignment -name output_pin_load 10 -to addr_out[1]

## End of pin_assignments.tcl
```

TimeQuest Constraint File `demo_design.sdc`

TimeQuest reads the SDC file `demo_design.sdc` and applies timing constraints for the system clock, `ref_clk`, and I/O-to-core timing specifications.

```
## constraints.sdc
create_clock -period 10.0 MHz -name ref_clk [get_ports ref_clk]

set_clock_latency -late 3 ref_clk
set_clock_latency -early 2 ref_clk
set_clock_uncertainty -hold -to ref_clk 0.250
set_clock_uncertainty -setup -to ref_clk 0.250

# Input delay of 6ns (max) & 2ns (min) for bus data_in[1:0]
set_input_delay -clock ref_clk -max 6 [get_ports data_in]
```

```

set_input_delay -clock ref_clk -min 2 [get_ports data_in]
# Output delay of 6ns (max) & 2ns (min) for bus data_out[1:0]
set_output_delay -clock ref_clk -max 6 [get_ports data_out]
set_output_delay -clock ref_clk -min 2 [get_ports data_out]

# Don't care about timing on the resetn net. Set as false path
set_false_path -from [get_ports resetn]
## End of timing_assignments.tcl

```

Timing Assignments Script `timing_assignments.tcl`

If you are using Classic Timing Analyzer, the `timing_assignments.tcl` script is run from the top-level script, `demo_design.tcl`. This script applies timing constraints for the system clock, `ref_clk`, and I/O-to-core timing specifications.

```

## timing_assignments.tcl
create_base_clock -fmax 10.0ns -target ref_clk ref_clk

set_instance_assignment -name LATE_CLOCK_LATENCY 3ns -to ref_clk
set_instance_assignment -name EARLY_CLOCK_LATENCY 2ns -to ref_clk
set_clock_uncertainty -hold -to ref_clk 0.250ns
set_clock_uncertainty -setup -to ref_clk 0.250ns

# Input delay of 6ns (max) & 2ns (min) for bus data_in[1:0]
set_input_delay -clk_ref ref_clk -max -to data_in 6.0ns
set_input_delay -clk_ref ref_clk -min -to data_in 2.0ns
# Output delay of 6ns (max) & 2ns (min) for bus data_out[1:0]
set_output_delay -clk_ref ref_clk -max -to data_out 6.0ns
set_output_delay -clk_ref ref_clk -min -to data_out 2.0ns

# Don't care about timing on the resetn net. Set as false path
set_timing_cut_assignment -from resetn
## End of timing_assignments.tcl

```

Summary

This chapter introduced script-based design for HardCopy II devices using the Quartus II interactive Tcl shell. This approach provides you with an alternative to GUI-based design for certain situations such as remote-terminal Quartus II execution, design flow automation, or even if you are simply more comfortable operating in a scripting environment.

Document Revision History

Table 6–10 shows the revision history for this chapter.

Date and Document Version	Changes Made	Summary of Changes
September 2008, v1.3	Updated chapter number and metadata.	—
June 2007, v1.2	Minor text edits.	—
December 2006 v1.1	Updates for the Quartus II software version 6.1.0 <ul style="list-style-type: none"> • Added information on the Tcl command-line executable <code>quartus_sta</code>, newly available in Quartus II software version 6.1.0, and recommended for use in HardCopy II design timing analysis. • Updated Figure 6–1. • Updated Table 6–1, Table 6–2, and Table 6–3. • Added revision history. 	A medium update to the chapter, due to changes in the Quartus II software version 6.1 release.
March 2006	Formerly chapter 15; no content change.	—
October 2005 v1.0	Initial release of <i>Script-Based Design for Hardcopy II Devices</i> .	—

Introduction

In a Stratix® II FPGA design, a complete and accurate set of timing constraints is often not critical to achieving a fully functioning product. The reconfigurability of the FPGA means that if a timing-related problem occurs during hardware test and verification, the device can be reprogrammed to correct it. No ASIC re-spin or board-level work-around is necessary and the fix can be implemented in a timely and cost-effective way.

In contrast, a HardCopy® II design results in a mask-programmed, structured ASIC device. Timing problems may result in long design-change turn-around times and high NRE costs. To ensure a smooth transition through the Quartus® II software and back-end design in the Altera® HardCopy Design Center (HCDC), Altera strongly recommends that you use the TimeQuest timing analyzer provided with the Quartus II software and that you follow the timing considerations and timing constraint recommendations given in this chapter. Use of the TimeQuest timing analyzer for Design Review 2 (DR2) in the HardCopy II design flow will soon be mandatory.

The TimeQuest timing analyzer is a complete static timing analysis tool that you can use as a sign-off tool for Altera FPGAs and structured ASICs. As FPGA devices become denser and faster, they are the targets of complex designs and applications that previously were implemented in ASICs. These complex designs push the limits of the traditional Classic Timing Analyzer, affecting designer productivity. The Quartus II TimeQuest timing analyzer, in contrast, works well on complex designs. Its intuitive user interface, support of industry-standard Synopsys Design Constraints (SDC) format, and scripting capabilities all result in increased productivity and efficiency.



For more information on the features and capabilities of the TimeQuest timing analyzer, refer to the *TimeQuest Timing Analyzer* chapter in volume 3 of the *Quartus II Handbook*.

This chapter includes the following information:

- A description of timing-related differences between HardCopy II structured ASICs and Stratix II FPGAs
- Descriptions and a comparison of the TimeQuest timing analyzer and the Classic Timing Analyzer

- An explanation of the use of timing constraints in the Quartus II software, including some of the important timing-related checks reported by the HardCopy II Advisor and Design Assistant
- Timing constraint recommendations for your HardCopy II project and recommendations for handling legacy designs that use timing constraints not supported in the HardCopy II design flow

HardCopy II versus Stratix II Timing

The back-end design of your HardCopy II structured ASIC includes timing closure in accordance with the timing specification achieved in the Quartus II software for the Stratix II FPGA prototype and HardCopy II device. However, you should be aware that this does not mean that actual path timing in the Stratix II FPGA is duplicated in the HardCopy II device. In fact, because of the architectural differences between Stratix II and HardCopy II devices, you should expect that while internal and I/O path timing are within whatever timing constraints you applied, actual path delays are different.

The key factors that impact timing differences between Stratix II and HardCopy II devices are listed below.

- The HardCopy II die is significantly smaller than its Stratix II counterpart
- Coarse-grain adaptive logic modules (ALMs) in Stratix II devices are mapped to fine-grain HCell macros in HardCopy II devices
- Design connections are implemented using custom metal routing in HardCopy II devices
- HardCopy II devices contain no SRAM-configurable programmable connection points
- Leaf sub-trees in HardCopy II global clock networks are custom routed

The following sections briefly describe the effect of these factors on HardCopy II timing characteristics.

Internal Register-to-Register Timing

Internal timing is the timing of paths from register to register within core logic. Internal timing is dependent on the transport delays of logic elements on register-to-register paths and the overall effects of parasitic capacitance, parasitic resistance, and crosstalk on routing connections between those logic elements.

User-logic implementation in HardCopy II devices is more area efficient and often has improved timing when compared with the Stratix II FPGA. These advantages are the result of re-mapping the coarse-grain,

programmable ALMs in Stratix II devices to fine-grain HCell macros in HardCopy II devices. All ALM functions are re-mapped to HCells in HardCopy II devices. Using fine-grain HCells eliminates the need for the programmable routing multiplexers (MUXs) found inside the Stratix II ALM blocks. This reduces the number of levels of logic required to implement ALM functions from the Stratix II device. Consequently, the transport, or propagation, delays associated in the Stratix II FPGA with ALMs in register-to-register paths are smaller in the HardCopy II device.

The HardCopy II device does not require configuration SRAM, so die size is significantly smaller than for Stratix II counterpart devices. One effect of reduced die size is that overall routing length is shorter. In addition, HardCopy II devices use customization of metal layers 5 and 6 to implement user-logic connections. The fact that no configuration SRAM is required eliminates the need for SRAM-configurable routing switches and programmable connection points, all of which adversely affect timing. Therefore, overall, parasitic capacitance and resistance and crosstalk levels are often lower in the HardCopy II device, leading to faster connections than those found in the Stratix II FPGA.

Faster logic element implementation and faster routing in HardCopy II devices generally result in faster register-to-register paths and higher overall clock frequencies. Software place-and-route tools have a significant impact on timing results, however, so there are cases where Stratix II register-to-register paths are faster than the corresponding paths in the HardCopy II device.

The internal timing performance of digital signal processing (DSP) functions is similar in a Stratix II FPGA and its corresponding HardCopy II device. In Stratix II FPGAs, DSP functions are usually implemented in the embedded DSP blocks. These DSP blocks provide optimal area and performance for DSP functions. In HardCopy II devices, the same DSP functions are implemented in HCell DSP macros, which are designed to match the functionality and timing of the DSP blocks in Stratix II devices. However, the timing performance of paths between the DSP functions and other core logic is generally faster in the HardCopy II device than in the Stratix II FPGA.

RAM-block access time is similar in a Stratix II FPGA and its corresponding HardCopy II device. However, as for DSP functions, the timing performance of paths between the RAM blocks and other core logic is generally faster in the HardCopy II device than in the Stratix II FPGA.

I/O Path Timing

The actual timing and parametric characteristics of I/O cells in HardCopy II devices are very similar to those in Stratix II devices. You should expect, however, to see differences in I/O signal path timing. These differences are primarily because of timing differences in core-to-I/O and clock distribution.

For core-to-I/O timing, one of the largest influencing factors is the timing behavior of signal paths, as described in the “[Internal Register-to-Register Timing](#)” section. In general, core-to-I/O and I/O-to-core timing are different between HardCopy II and Stratix II devices.

The other major influence on I/O timing is the clock distribution differences between HardCopy II and Stratix II devices. Shorter, faster clock trees, custom clock tree buffering and custom routing of leaf sub-trees in HardCopy II mean that insertion delays, latencies, skew characteristics, jitter, and PLL compensation are different from the Stratix II FPGA. The effect of this is described in the “[Clock Distribution Effects](#)” section.

Clock Distribution Effects

The HardCopy II structured ASIC has a clock distribution scheme that is similar to that in Stratix II FPGAs with some notable differences:

- There are no SRAM-programmable switches and routing connections
- Reduced die-size means shorter overall clock tree routing length
- Leaf sub-trees of clock networks are custom routed using customized metal mask layers

These physical differences affect clock distribution characteristics across the device. Timing characteristics most affected are:

- Clock tree latency and clock insertion delay
- Clock skew
- Clock jitter
- PLL compensation delays

In general, clock tree latencies are smaller in the HardCopy II device because of shorter routing length and the absence of SRAM-programmable switches. As a result, you should expect that any clock insertion delays that are modeled will also be shorter.

The most significant impact of reduced clock tree latency is the changes in core-to-I/O and I/O-to-core timing. For example, if an I/O register is clocked earlier because of reduced clock latency, the arrival time of the register output at the device pin is reduced. Similarly, if an input register is clocked earlier, the setup time for that register is also earlier, and the hold time requirement is relaxed.

The Quartus II software accommodates these differences to ensure that your timing requirements are satisfied. However, you should be aware that reduced clock insertion delay causes I/O timing differences between your Stratix II FPGA prototype and a HardCopy II-structured ASIC.

PLL Characteristics

Many of the effects described in the “Clock Distribution Effects” section also apply to the clock outputs from PLLs between Stratix II and HardCopy II devices. The Quartus II software implements compensation delays for PLLs in your HardCopy II device to account for differences in PLL clock distribution. This ensures that the compensation modes used in the Stratix II FPGA are also used in the HardCopy II structured ASIC.

HardCopy II Timing Closure Methodology

To achieve timing closure for your HardCopy II structured ASIC, it is imperative that you use a complete set of accurate timing constraints throughout the flow. For the Stratix II FPGA prototype, although you may verify timing and functionality in hardware, it is essential that the design be compiled and verified in the Quartus II software using a complete set of timing constraints. These constraints feed forward to the HardCopy II revision of the project, and ultimately to the HardCopy Design Center (HCDC).

The back-end design of your structured ASIC in the HCDC ensures that it conforms to whatever timing constraints are satisfied in the Quartus II software. It is important to remember that while the Quartus II timing constraints are respected, the actual Stratix II FPGA prototype timing you observe in hardware is not duplicated in the HardCopy II structured ASIC. The timing differences between the Stratix II device and the HardCopy II structured ASIC are inconsequential as long as both are checked against a complete set of timing constraints.

HardCopy II Timing Closure Flow

HardCopy II timing closure methodology is comprehensive and includes both the TimeQuest timing analyzer and Classic Timing Analyzer in the Quartus II software, an interface to a third-party static timing analyzer, and FPGA-prototype timing verification in the hardware.

Altera recommends you use the TimeQuest timing analyzer. You can specify that the TimeQuest timing analyzer be used by the Quartus II software rather than the default Classic Timing Analyzer.

The TimeQuest timing analyzer validates the timing performance of all logic in your design using an industry-standard constraint, analysis, and reporting methodology. It provides powerful timing analysis features that enable thorough timing analysis of high-performance designs. The benefits of using TimeQuest for timing analysis include these features:

- **Native SDC support**—You can leverage this powerful industry-standard timing constraint format to achieve a higher degree of productivity by using and reusing SDC- and Tcl-based scripts.
- **Fast on-demand and interactive data reporting**—This feature saves time by allowing you to request more detailed timing analysis on critical paths only. A powerful GUI reports the timing analysis data in an intuitive graphical format that complements the fast, on-demand data reporting, further enhancing productivity.

Classic Timing Analyzer supports HardCopy II timing analysis. However, TimeQuest provides more powerful timing analysis features. Some Classic Timing Analyzer timing constraints may not be translated from the Quartus Setting file to SDC format constraints when the design is transferred to the HCDC, because translating these constraints is difficult and error-prone and often requires detailed analysis of the particular context in which the constraint is used.

The timing closure methodology used in the Quartus II software for a HardCopy II design is shown in [Figure 7-1](#). This diagram shows the FPGA-first static timing analysis flow for either the TimeQuest timing analyzer or the Classic Timing Analyzer. For the HardCopy II first flow, the methodology is the same except that the HardCopy II compilation is performed before the Stratix II compilation.

Figure 7-1. Stratix II First Timing Closure Flow Note (1)

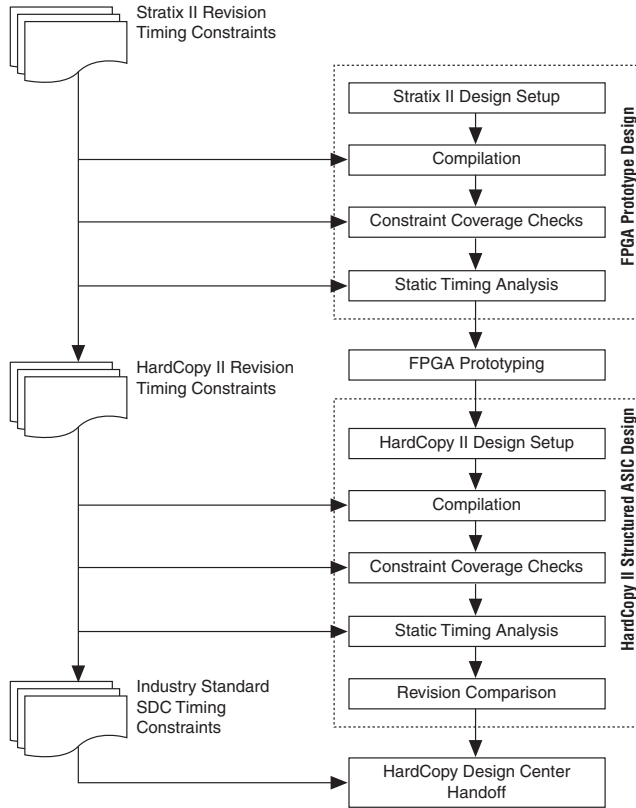

Note to Figure 7-1:

- (1) Timing constraints are required in Stratix II revision and HardCopy II revision. The TimeQuest timing analyzer supports industry-standard SDC files (.sdc) and Classic Timing Analyzer supports Quartus Setting File (.qsf).

As you can see from Figure 7-1, timing constraints are used very early in the Quartus II design flow. During the Stratix II FPGA prototype compilation, these constraints are used as the timing target for timing-driven compilation. When the compilation is complete, the TimeQuest timing analyzer or Classic Timing Analyzer reports timing results for your design. Any failed timing reports mean that you must either modify your timing constraints, change your compile settings and recompile, or both. In addition, the timing constraint checkers in both TimeQuest and Classic Timing Analyzer report the unconstrained timing paths. See “Using the TimeQuest Timing Analyzer” on page 7-8 for details. For timing verification in third-party tools, the Quartus II

software can generate static timing analysis scripts for use in Synopsys PrimeTime tools. In addition, timing can be further verified in third-party, timing-driven simulation tools.

When software timing verification of the Stratix II prototype FPGA is complete, you can verify your prototype in hardware. It is a requirement of the HardCopy II design flow that you fully verify the Stratix II FPGA prototype timing over the range of operating conditions that your design is exposed to.

The next step is to create and compile your HardCopy II design revision. By default, your HardCopy II compilation is run with the same timing constraints used during the compilation and verification of your Stratix II FPGA. If you wish to change the target timing specifications for the HardCopy II revision, you can do so by changing the HardCopy II timing constraints before compiling. When the HardCopy II compilation is complete, just as you do after the Stratix II compilation, run TimeQuest or Classic Timing Analyzer to check timing results. You should review and resolve any timing failures that are reported.

One of the final steps in the HardCopy II design flow in the Quartus II software is the revision comparison check. Part of this check compares timing constraints and settings between the Stratix II and HardCopy II revisions of the project. Any differences between the two are reported. If you change the timing constraints after completing Stratix II FPGA prototyping, the Revision Compare tool will report the change and you will be asked to waive this difference in the design review.

When your Quartus II design is transferred to the HCDC, it includes an industry-standard (SDC) version of the HardCopy II timing constraints. This version is the set of legal timing constraints for the design that include commands only from the **sd**c package in the Quartus II software. For the HardCopy II design flow, you may not use any commands except those in the **sd**c package in the Quartus II software. In addition, you must correct all timing constraints that generate warning messages in the Quartus II software.



For more detailed information on the Quartus II **sd**c package, refer to the **sd**c package section in the *Tcl Packages and Commands* chapter of the *Quartus II Scripting Reference Manual*.

Using the TimeQuest Timing Analyzer

The TimeQuest timing analyzer plays an integral part in the Quartus II HardCopy II timing closure flow, from the specification of timing constraints to the verification of design requirements.

The TimeQuest timing analyzer provides a number of timing checks during the HardCopy II design flow. The HardCopy II Advisor guides you to launch the TimeQuest timing analyzer for these timing checks and ensures that the design is fully constrained, as shown in [Figure 7–2](#).

Figure 7–2. TimeQuest Timing-Related Settings in the HardCopy II Advisor

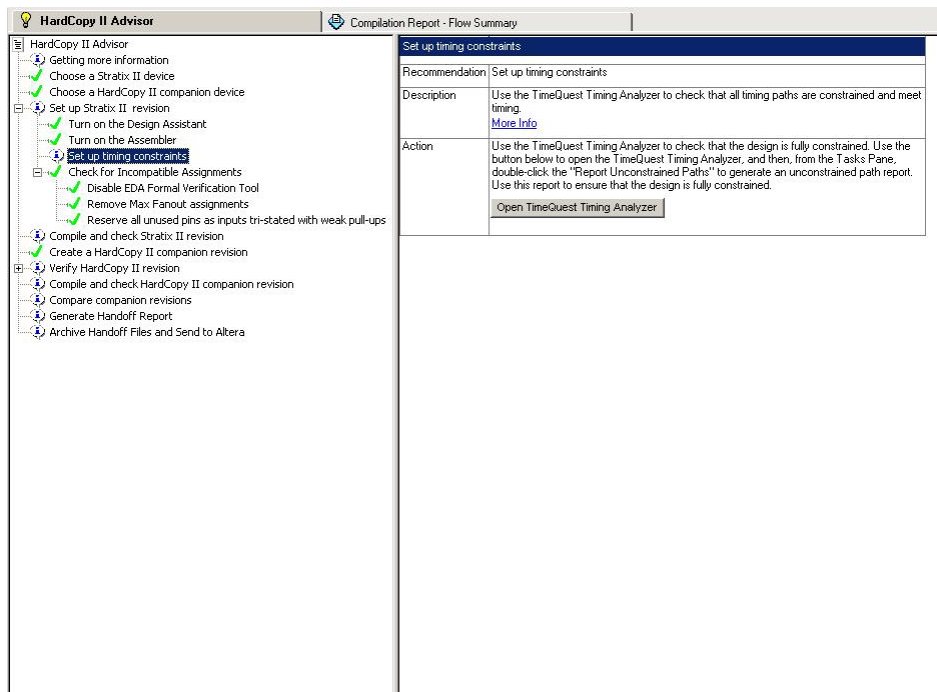

All timing paths must be fully constrained. The TimeQuest `report_ucp` command (or the TimeQuest GUI **Tasks** pane option **Report Unconstrained Paths**) generates a series of reports that detail all unconstrained paths in your design. These reports list unconstrained setup, hold, recovery, and removal timing paths in the design. You must correct any design errors the report shows you by applying additional constraints before running static timing analysis.

The TimeQuest timing analyzer supports most constraints in the SDC format for the HardCopy series of devices. The TimeQuest timing analyzer constraints are specified in commands from two Tcl packages in the Quartus II software. These packages are the `sdc` package and the `sdc_ext` package. The HardCopy II design flow requires that all timing constraints be specified in commands from the SDC Version 1.5

specification, as provided in the **sdc** package. Quartus II software returns warning messages in the early stage of the compilation for HardCopy II design flow if the SDC file contains any constraints that use commands from the TimeQuest extension to the SDC Version 1.5 specification, which are provided in the **sdc_ext** package. To enable a smooth transfer of the SDC file to the HCD (HardCopy Design Center) for back-end design, you should avoid using commands and options from the **sdc_ext** package.



For more detailed information on the Quartus II **sdc** and **sdc_ext** packages, refer to the **sdc** package section in the *Tcl Packages and Commands* chapter of the *Quartus II Scripting Reference Manual* and to the *SDC and TimeQuest API Reference Manual*.

In addition to these timing-related checks, you should review the Quartus II timing report sections in the **Compilation Report** and resolve any timing violations that may be reported (Figure 7-3).

Figure 7-3. TimeQuest Unconstrained Timing Path Report

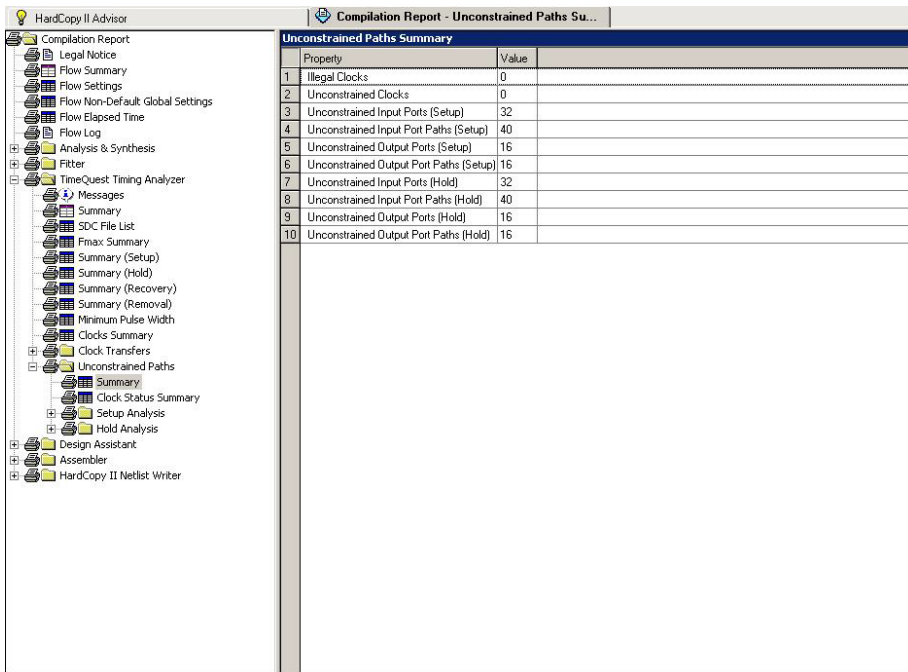



For more detailed information about the features and capabilities of the TimeQuest timing analyzer, refer to the *TimeQuest Timing Analyzer* chapter in volume 3 of the *Quartus II Handbook*.

Using Classic Timing Analyzer

Classic Timing Analyzer analyzes the delay of every design path and analyzes all timing requirements to ensure correct circuit operation. As part of the compilation flow, the Quartus II software automatically performs static timing analysis so that you do not need to launch a separate timing analysis tool. Classic Timing Analyzer checks every path in the design against your timing constraints for timing violations and reports results in the Timing Analysis reports, giving you immediate access to the data.

Quartus II Timing Related Checks and Settings

The Classic Timing Analyzer provides a number of timing related checks as you go through a HardCopy II design flow. The HardCopy II Advisor can guide you through these checks and ensure that you perform all steps required to successfully complete a HardCopy II design.



For more information on the HardCopy II Advisor and the checks performed by the Design Assistant, refer to the *Design Guidelines for HardCopy Series Devices* chapter in the *Hardware Design Considerations* section of the *HardCopy Series Handbook*.

The HardCopy II Advisor advises on the correct Quartus II settings for timing analysis (Figure 7-4). These settings are necessary to ensure you generate accurate and complete timing reports. The list of settings includes the following:

- Enable Recovery/Removal Analysis
- Enable Timing Constraints Check
- Report Combined Fast/Slow Timing
- Report I/O Paths Separately
- Enable Clock Latency
- Enable Misc. Timing Assignments

In the Classic Timing Analysis flow, you must set the value of `CUT_OFF_PATHS_BETWEEN_CLOCK_DOMAINS` to **OFF**. Otherwise, the unconstrained path report (UCP report) will list all clock domain crossing paths as unconstrained. The report does not honor the ON setting, which cuts timing from clocks not originating from the same PLL.

Figure 7-4. Classic Timing-Related Settings in the HardCopy II Advisor

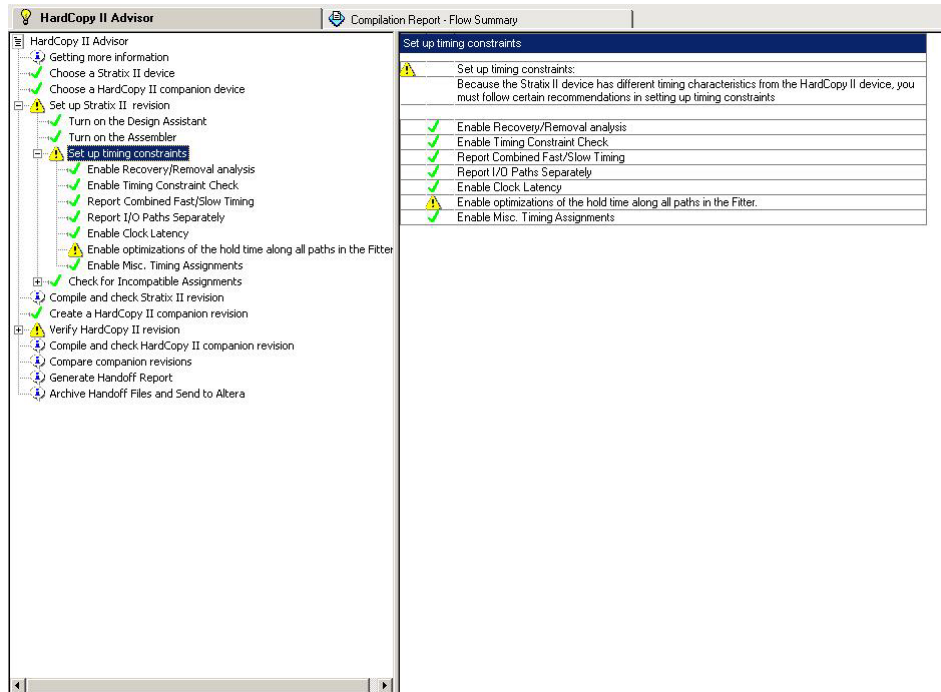

Classic Timing Analyzer, unlike the TimeQuest timing analyzer, supports some timing constraints that are incompatible with the HardCopy II design. In the HardCopy II Advisor, the **Remove Unsupported Global Timing Assignments** option and the **Remove Unsupported Instance Timing Assignments** option in the **Check for Incompatible Assignments** list (Figure 7-5) together list all the timing constraints that are incompatible with the HardCopy II design flow. These constraints are explained in “[Unsupported HardCopy II Timing Constraints for Classic Timing Analyzer](#)” on page 7-21.

Although Quartus II successfully completes timing analysis if you do not remove these timing constraints, it is very important that you correct all unsupported timing assignments before you transfer the HardCopy II design to the HCDC. Failure to remove these incompatible constraints may result in delays during back-end timing closure.

Figure 7–5. Classic Timing Analyzer Unsupported Timing Assignments in HardCopy II Advisor

The screenshot shows the HardCopy II Advisor interface. On the left is a task list with various icons (info, success, warning, error) and expandable sections. The task 'Remove Unsupported Instance Timing Assignments' is highlighted. On the right, a table provides details for this recommendation.

Remove Unsupported Instance Timing Assignments	
Recommendation	Remove Unsupported Instance Timing Assignments
Description	The instance timing assignments listed in the table are not supported for HardCopy II development and must be removed. Please use the supported assignments as described in the HardCopy II chapter of the Quartus II Handbook. More Info
Action	Remove the instance timing assignments listed in the table using the Assignment Editor (Assignments menu). Please use the supported assignments as described in the Quartus II Handbook. No action is needed for this recommendation. The recommended setting has been made. Open Assignment Editor - Timing category

The **Compilation Report** for both the Stratix II and HardCopy II revisions of your project includes a **Timing Constraints Check** section (Figure 7–6). This section reports all unconstrained paths based on the coverage provided by the timing constraints used in the design. You should examine this report and verify that all internal and I/O paths and all clock domains are constrained for both setup and hold checks.

Figure 7–6. Classic Timing Analyzer Constraints Check in Compilation Report

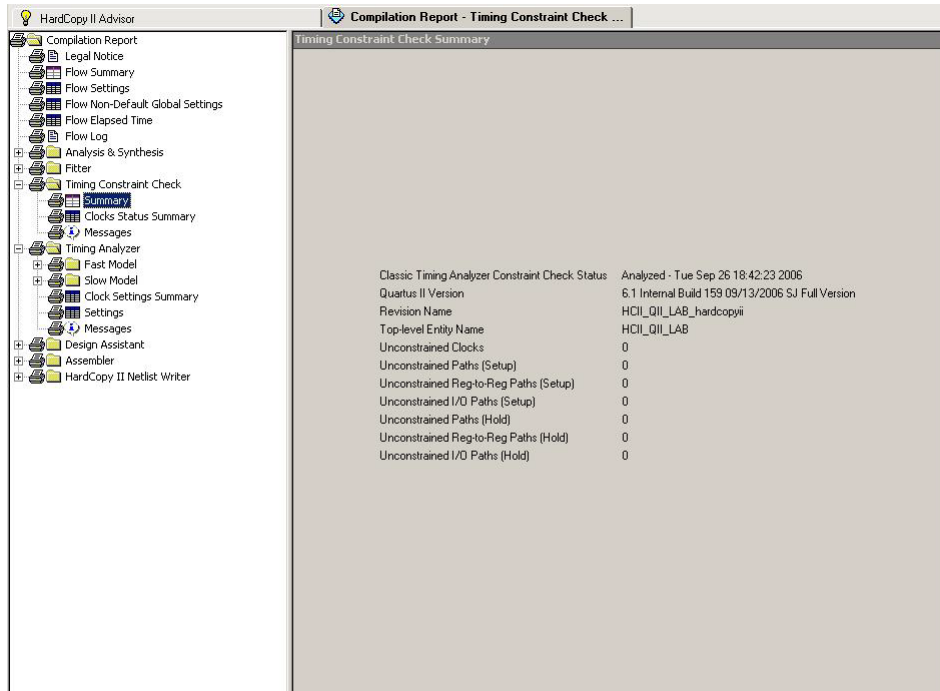

When using Classic Timing Analyzer, just as when using the TimeQuest timing analyzer, you should review the Quartus II timing report sections in the **Compilation Report** and resolve all reported timing violations.

Constraining Timing of HardCopy Series Devices

To ensure that the timing of the HardCopy device meets performance goals, the HardCopy Design Center runs static timing analysis on the design database. For this timing analysis to be meaningful, all timing constraints and timing exceptions that you applied to the design for the FPGA implementation, must also be used for the HardCopy implementation. If you did not use timing constraints or you used only partial timing constraints for the design, you must add constraints to

make the design fully constrained, and use the same constraints for both FPGA and HardCopy revisions in the flow. If you do not do this, you cannot determine whether the HardCopy series device meets the required timing of the end target system. The SDC format timing constraints can be generated using the Quartus II SDC File Editor which provides line numbering, syntax coloring, and call tips. You can enter timing constraints and exceptions directly or specify them from the Constraints menu. An example of the SDC commands is shown in the following section.

The following constraints must be included:

- Clock definitions
- Primary input port timing
- Primary output port timing
- Combinational timing
- Timing exceptions



For information on the SDC editor, refer to the *TimeQuest Timing Analyzer* chapter in volume 3 of the *Quartus II Handbook*.



For more information on timing constraints for the TimeQuest timing analyzer, refer to the *TimeQuest Timing Analyzer* chapter in volume 3 of the *Quartus II Handbook*.



For more information on timing assignments for Classic Timing Analyzer, refer to the *Classic Timing Analyzer* chapter in volume 3 of the *Quartus II Handbook*.

Clock Definitions

You can use these definitions to describe the parameters of all different clock domains in a design. Clock parameters that must be defined are frequency, time at which the clock edge rises, time at which the clock edge falls, clock uncertainty (for example: jitter, noise, and designed in timing margin), and clock name. [Figure 7-7](#) illustrates the attributes.

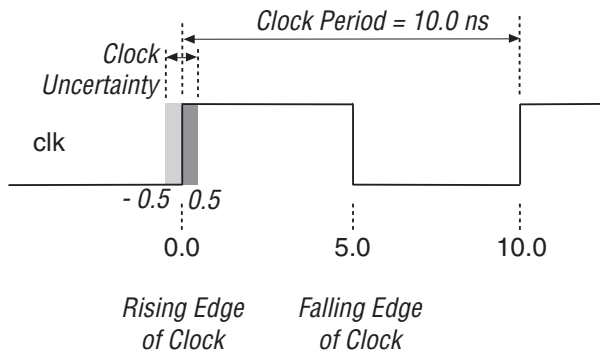
Figure 7-7. Clock Attributes

The clock settings for PLL clocks are derived automatically based on the PLL settings and reference clock characteristics. You can also override the default PLL clock settings for timing analysis by specifying clock settings for the input clock port on the PLL.

Clock uncertainty in PLL clock outputs is not modeled by default. You should use the `set_clock_uncertainty` command to model jitter and any other uncertainty and margin in your PLL clocks.



Consult with your Altera Field Applications Engineer (FAE) or use MySupport regarding PLL clock uncertainty calculation for your design.

The SDC format provides a simple and easy method to constrain the simplest to the most complex designs. The following example illustrates the simplest SDC commands for a clock (port or pin) and for a generated clock at the PLL output pin for a design:

```
#Constrain the base clock
create_clock -period 10.000 [get_ports clk_in]

#Constrain the PLL output clock
derive_pll_clocks
```



Although `derive_pll_clocks` is in the `sdc_ext` package, it is the unique exception to the requirement that all timing constraints in the HardCopy II design flow must be in the `sdc` package. This command is automatically translated to the `sdc`-package command `generated_pll_clock` prior to transfer to the HCD.



For a full list of available report APIs, refer to the *SDC and TimeQuest API Reference Manual*.

Primary Input Port Timing

You must specify the primary input port timing constraint for every primary input port in the design (and for the input path of every bidirectional port). The following two subsections describe how to constrain input port timing.

External Input Delay Specification

To constrain the input port timing, describe the external timing environment in terms of the maximum and minimum arrival times of the external signals that drive the primary input ports of the HardCopy series device or FPGA. Figure 7-8 shows the external timing constraint that drives the primary input port. The static timing analysis tool can use this external input delay time to check if there is enough time for the data to propagate to the internal nodes of the device. If there is not enough time, a timing violation occurs.

Figure 7-8. External Timing Constraint Driving a Primary Input Port

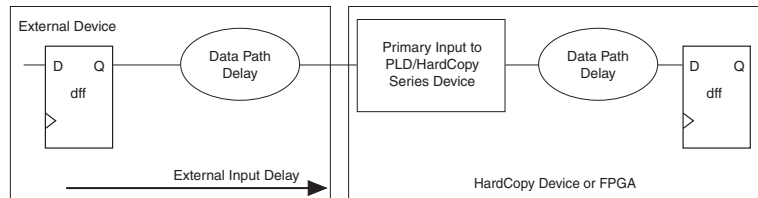

Internal Input Delay Specification

This approach describes the acceptable maximum on-chip delay for your design. For example, you can use this approach to describe the setup time of a primary input to any register in the design relative to a specific clock. Figure 7-9 shows a generic circuit with an on-chip setup-time constraint, which may be different for each clock domain. You may specify the minimum on-chip delay from any primary input port to describe input hold-time requirements.

Figure 7-9. Internal Input Delay Specification (Setup)

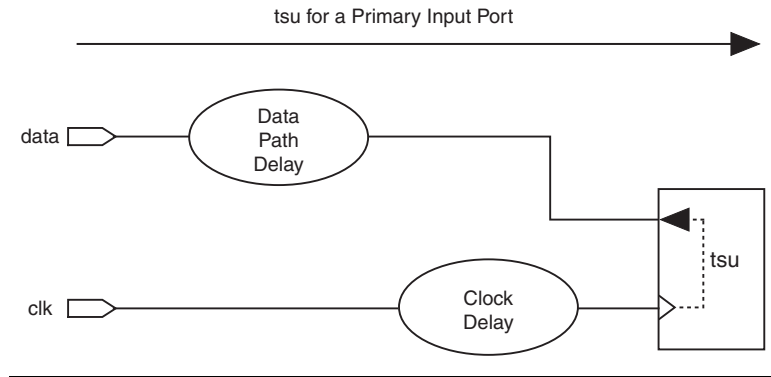
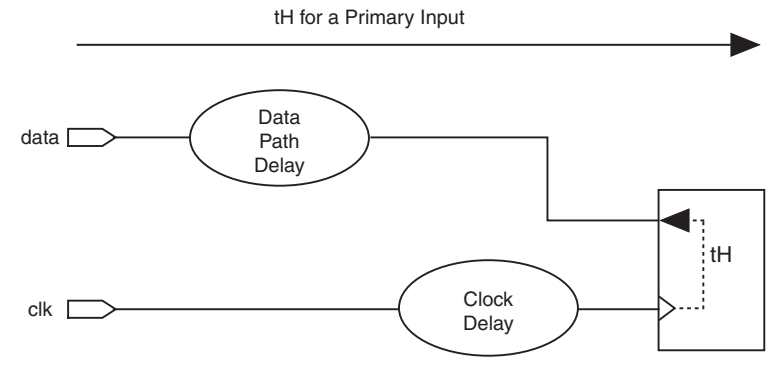

Figure 7-10 shows a generic circuit with an on-chip hold-time constraint.

Figure 7-10. Internal Input Delay Specification (Hold)



Primary Output Port Timing

You must specify the output port timing constraint for every primary output port in the design and for the output path of every bidirectional port. There are two ways to capture the output port timing, as described in the following two sections.

External Output Delay Specification

One way to capture output port timing is to describe the external timing environment, which is the maximum and minimum delay times of external signals that are driven by the primary output ports of the HardCopy series device. Figure 7–11 shows the external timing constraint driven by the primary output port. The static timing analysis tool uses this information to check that the on-chip timing of the output signals is within the desired specification.

Figure 7–11. External Timing Constraint for a Primary Output Port

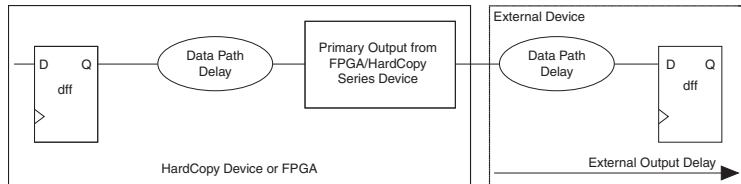

Internal Output Delay (T_{CO}) Specification

This approach describes the acceptable maximum and minimum on-chip clock-to-output (T_{CO}) delay. For example, you can use this approach to describe the time it takes from the active edge of the clock to the data arriving at the primary output port. Figure 7–12 shows a generic circuit with an on-chip T_{CO} time constraint. In addition, there can be a minimum T_{CO} requirement.

Figure 7–12. On-Chip Clock-to-Output (T_{CO}) Time Constraint

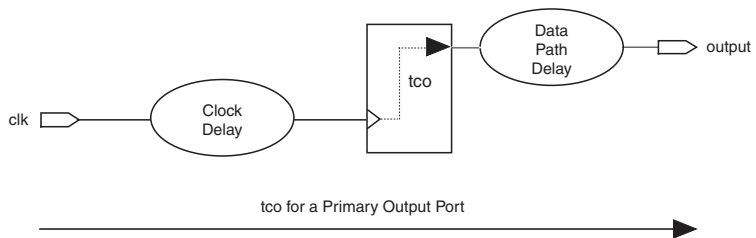

Combinational Timing

In combinational timing circuits, a path exists from a primary input port to a primary output port. This type of circuit does not contain any registers. Therefore, it does not require a clock for constraint specification. You only need the maximum and minimum delay from the primary input port to the primary output port to constrain the path for timing requirements. Figure 7–13 shows the placement requirement for a combinational delay arc constraint in a generic circuit.

Figure 7–13. Combinational Timing Constraint

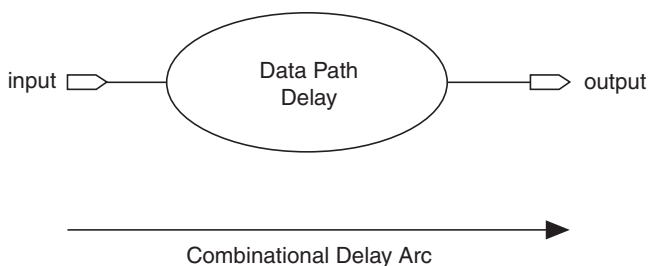

Timing Exceptions

Some circuit structures warrant special consideration. For example, you can ignore all timing paths between two clock domains when a design has more than one clock domain and the clock domains are not related. You can ignore all timing paths using the static timing analysis tool by specifying false paths for all signals that go from one clock domain to the other clock domain(s). Additionally, some circuits are not intended to operate in a single-clock cycle. These circuits require that you specify multi-cycle clock exceptions.

After capturing the information, the Altera HCDC directly checks all timing of the HardCopy series device before tape-out occurs. If any timing violations occur in the HardCopy series device due to overly aggressive timing constraints, Altera must fix them, or you must waive them.

Unsupported HardCopy II Timing Constraints for Classic Timing Analyzer

The Quartus II software supports a wide variety of complex timing constraints. When using Classic Timing Analyzer for HardCopy II design, however, some of these constraints are not translated to SDC format constraints when the design is transferred to the HCDC. The unsupported timing constraints for HardCopy II are listed below:

- Clock enable multicycle paths
- Inverted clocks
- TSU, Th, TCO, and Min T_{CO}
- Internal T_{PD}
- Virtual clocks
- Maximum clock and data skew
- Maximum and minimum delay

If these constraints are used, you can still perform timing analysis in the Quartus II software and produce the correct results. However, when a HardCopy II archive for handoff is created, they will be ignored. The translation of Quartus II timing constraints to SDC constraints simply drops unsupported constraints; they do not feed forward to the HCDC. Any unsupported constraints in a design are listed under the **Incompatible Assignments** section in the HardCopy II Advisor (see [Figure 7-5](#)).

While it is possible to translate unsupported constraints to constraints that are supported, the process is difficult and error-prone, often requiring detailed analysis of the particular context in which the constraint is used.

For this reason, Altera recommends that you use timing constraints in the industry-standard SDC format with the TimeQuest timing analyzer or use only supported timing constraints for Classic Timing Analyzer from the start of your HardCopy II project. This approach avoids any translation or constraint coverage issues that may occur later in a project and the inevitable delay and risk that results.

In some cases, a HardCopy II project in the Quartus II software may already be using the unsupported constraints, and you may choose either to translate the existing, unsupported constraints, or replace them with a new set of constraints that use only the recommended HardCopy II timing assignments. In many cases, you may find it easier to rebuild the constraints rather than translate existing constraints. This is because of the ambiguous nature of many unsupported timing constraints, which often require additional information outside of the Quartus II software before the translation can be properly resolved. Verifying that the translations produce the same timing constraint coverage and the same timing analysis results can also be a time-consuming and error-prone exercise.

If you do wish to translate existing, unsupported timing constraints to recommended constraints, use [Table 7-1](#) as a rough guide. It shows how values used in TCO, Th, TSU, and Min T_{CO} assignments normally convert to values used in recommended HardCopy II assignments. In the table, unsupported constraints are listed in the left hand column.

Recommended constraints are listed along the top row. To use the table, cross-reference the unsupported constraints you wish to translate against a recommended constraint. The cross reference cell contains the conversion of the original, unsupported constraint value that should be used with the new, recommended constraint. It is very important to note that these translations are not valid in every design scenario.

	setup_relationship	set_input_delay	hold_relationship	set_output_delay
TSU Req	TSU	-max <TCK-TSU>		
Th Req		-min Th	-Th	
TCO Req	TCO			-max <TCK-TCO>
Min T_{CO} Req			Min T _{CO}	-min <- Min T _{CO} >

Note to Table 7-1:

- (1) TSU = value used in the TSU requirement assignment.
- (2) TCO = value used in the TCO requirement assignment.
- (3) Th = value used in the Th requirement assignment.
- (4) Min T_{CO} = value used in Min T_{CO} requirement assignment.
- (5) TCK = period of the clock for registers associated with the TSU and TCO requirements.

Conclusion

This chapter described timing considerations and Quartus II timing constraint recommendations for HardCopy II projects. By understanding these considerations and following the recommendations in your design, you ensure a smooth transition through the Quartus II software and subsequent transfer to the Altera HardCopy Design Center for the back-end design of your structured ASIC. Following the recommendations in this chapter will help ensure success in your HardCopy II project.

Document Revision History

Table 7–2 shows the revision history for this chapter.

Date and Document Version	Changes Made	Summary of Changes
September 2008, v2.2	Updated chapter number and metadata.	—
June 2007, v2.1	Minor text edits.	—
December 2006 v2.0	Major updates for the Quartus II software version 6.1.0 <ul style="list-style-type: none"> • Added information on TimeQuest timing analyzer, newly available in Quartus II software version 6.1.0, and recommended for use in HardCopy II design timing analysis. • Added “Using the TimeQuest Timing Analyzer” section. • Brought in “Constraining Timing of HardCopy Series Devices” section, previously in Chapter 22. • Updated “HardCopy II Timing Closure Methodology” section. • Added revision history. 	A major update to the chapter, due to changes in the Quartus II software version 6.1 release, especially the inclusion of the TimeQuest timing analyzer; most changes were in the “HardCopy II Timing Closure Methodology” section, and the addition of the “Using the TimeQuest Timing Analyzer” and “Constraining Timing of HardCopy Series Devices” sections.
March 2006, v1.0	Added document to the HardCopy Series Handbook.	—

Introduction

Altera® HardCopy® II devices and Stratix® II devices are both manufactured on a 1.2-V, 90-nm process technology and offer many similar features. Designers can use the Quartus® II software to migrate their Stratix II design to a HardCopy II device. The Quartus II software ensures that the design revision targeting a HardCopy II device retains the same functionality as the original Stratix II design.

Beginning with version 5.0 of the Quartus II software, you can select a HardCopy II companion device from the **Device Settings** dialog box (Device menu). Selecting a HardCopy II device as a companion device is similar to adding another Stratix II device in the migration device chain. The Quartus II software compiles the design to use the common resources available in all of the selected Stratix II devices and the selected HardCopy II devices. The HardCopy II companion device becomes the target device when you switch to the HardCopy II flow from this Stratix II flow later in the Quartus II project compilation.



For more information on compiling with Stratix II and HardCopy II companion revisions using Quartus II software, refer to the *Quartus II Support for HardCopy II Devices* chapter of the *HardCopy Series Devices Handbook*.

When you select a HardCopy II companion device, you can set the Quartus II Compiler to limit the design to the minimum resource availability of memory blocks and available logic for digital signal processing (DSP) from either the targeted Stratix II or HardCopy II companion device. Additional limitations also include I/O pin assignments and phase-locked loops (PLLs). This document is a guide for designers migrating Stratix II designs into HardCopy II devices. This document highlights resources that are not supported by the selected Stratix II and HardCopy II companion device pair or any resource differences between Stratix II devices and the HardCopy II device.

This document includes the following topics:

- Stratix II and HardCopy II Migration Options
- I/O Support and Planning
- External Memory Interface Support
- On-Chip Termination
- Stratix II and HardCopy II Companion Memory Blocks
- PLL Planning and Utilization

- Global and Local Signals
- Stratix II ALM Adaptation into HardCopy II Logic
- HardCopy II DSP Implementation from Stratix II DSP Blocks
- JTAG BST and Extended Functions
- Power Up and Configuration Compatibility

Stratix II and HardCopy II Migration Options

The Quartus II software allows you to migrate between different Stratix II devices in the same package. When compiling Stratix II designs in the Quartus II software, you can specify one Stratix II target device and one or more Stratix II migration devices. When you specify at least one migration device, the Quartus II Compiler constrains the overall design's I/O pins and other resource assignments to the minimum resources available in any of the selected migration devices. This feature allows vertical migration between devices using the same package footprint. To create the proper configuration file for one of the Stratix II devices selected in the migration devices menu, select that device as a target device.

The introduction of HardCopy II provides an additional seamless migration path for Stratix II devices. After you select a particular Stratix II device, the Quartus II software provides migration options in the **Settings** dialog box. For example, if your design targets the EP2S130 device in the 1,020-pin FineLine BGA® package, the Quartus II software provides the EP2S90 and EP2S180 devices in the 1,020-pin FineLine BGA package as migration options as well as the HC230 device in the 1,020-pin FineLine BGA package.

Conversely, the HardCopy II architecture allows you to design a structured ASIC and then prototype with a wide range of Stratix II devices. If the target device is a HardCopy II HC220 device in the 780-pin FineLine BGA package, you can select the Stratix II EP2S90 or EP2S130 device in the 780-pin FineLine BGA package as prototype devices.

[Table 8-1](#) shows vertical migration options by package.

Device	FineLine BGA Package					
	484 Pins	672 Pins	780 Pins	1,020 Pins	1,020 Pins	1,508 Pins
HardCopy II	HC210	HC220	HC220	HC230	HC240	HC240
Stratix II	EP2S30 EP2S60 EP2S90(2)	EP2S60	EP2S90 EP2S130	EP2S90 EP2S130 EP2S180	EP2S180	EP2S180

Notes to Table 8–1:

- (1) Table 8–1 does not include the HC210W device. For information on the HC210W device, contact the Altera Applications Group.
- (2) This is a Hybrid FineLine BGA package. For more details, refer to the *Package Information for Stratix II Devices* chapter in volume 2 of the *Stratix Device Handbook*.

Beginning with version 5.0 of the Quartus II software, when you compile a design targeting a HardCopy II device, you will need to select a target Stratix II device and a HardCopy II companion device for compilation. Table 8–2 lists the available HardCopy II and Stratix II companion pairs. These pairs are retained in most resource availability tables in this chapter to show the maximum resources available that are supported by either device of the companion pair.

Package	Companion Pair	
	HardCopy II Device	Stratix II Device
484-pin FineLine BGA	HC210	EP2S30
484-pin FineLine BGA	HC210	EP2S60
484-pin Hybrid FineLine BGA	HC210	EP2S90(2)
672-pin FineLine BGA	HC220	EP2S60
780-pin FineLine BGA	HC220	EP2S90
780-pin FineLine BGA	HC220	EP2S130
1,020-pin FineLine BGA	HC230	EP2S90
1,020-pin FineLine BGA	HC230	EP2S130

Table 8–2. Stratix II and HardCopy II Companion Devices (Part 2 of 2)
Note (1)

Package	Companion Pair	
	HardCopy II Device	Stratix II Device
1,020-pin FineLine BGA	HC230	EP2S180
1,020-pin FineLine BGA	HC240	EP2S180
1,508-pin FineLine BGA	HC240	EP2S180

Notes to Table 8–2:

- (1) Table 8–2 does not include the HC210W device. For information on the HC210W device, contact the Altera Applications Group.
- (2) This is a Hybrid FineLine BGA package. For more details, refer to the *Package Information for Stratix II Devices* chapter in volume 2 of the *Stratix Device Handbook*.

When the Quartus II software successfully compiles a design, the HardCopy II Device Resource Guide in the Fitter Compilation Report contains information on migration compatibility to a HardCopy II device. Use this information to select the optimal HardCopy II device for the prototype Stratix II device based on resource requirements and package preference.

Table 8–3 shows the available resources for prototyping on a Stratix II device when choosing a HardCopy II device. This chapter examines each resource availability in greater detail.

Table 8–3. Stratix II and HardCopy II Companion Devices Resource Availability Guide (Part 1 of 2) *Note (1)*

Stratix II and HardCopy II Companion Devices	Package	Stratix II ALMs (2)	HardCopy II Prototyping Resources						
			ASIC Gates for Logic	User I/O Pins (3)	M4K Blocks	M-RAM Blocks	Total RAM Bits	18 × 18 Multipliers	PLLs
EP2S30 HC210	484-pin FineLine BGA	13,552	360K	334	144	0	663,552	64	4
EP2S60 HC210	484-pin FineLine BGA	24,176	720K	334	190	0	875,520	144	4
EP2S90 HC210	484-pin FineLine BGA	36,384	1 M	308	190	0	875,520	192	4
EP2S60 HC220	672-pin FineLine BGA	24,176	720K	492	255	2	2,354,688	144	4
EP2S90 HC220	780-pin FineLine BGA	36,384	1 M	494	408	2	3,059,712	192	4

Table 8–3. Stratix II and HardCopy II Companion Devices Resource Availability Guide (Part 2 of 2) Note (1)

Stratix II and HardCopy II Companion Devices	Package	Stratix II ALMs (2)	HardCopy II Prototyping Resources						
			ASIC Gates for Logic	User I/O Pins (3)	M4K Blocks	M-RAM Blocks	Total RAM Bits	18 × 18 Multipliers	PLLs
EP2S130 HC220	780-pin FineLine BGA	53,016	1.6 M	494	408	2	3,059,712	252	4
EP2S90 HC230	1,020-pin FineLine BGA	36,384	1 M	698	408	4	4,239,360	192	8
EP2S130 HC230	1,020-pin FineLine BGA	53,016	1.6 M	698	609	6	6,345,216	252	8
EP2S180 HC230	1,020-pin FineLine BGA	71,760	2.2 M	698	614	6	6,368,256	384	8
EP2S180 HC240	1,020-pin FineLine BGA	71,760	2.2 M	742	768(4)	9	8,847,360	384	12
EP2S180 HC240	1,508-pin FineLine BGA	71,760	2.2 M	951	768(4)	9	8,847,360	384	12

Notes to Table 8–3:

- (1) Table 8–3 does not include the HC210W device. For information on the HC210W device, contact the Altera Applications Group.
- (2) ALM: adaptive logic module.
- (3) User I/O pin counts are preliminary. The Quartus II software I/O pin counts include one additional pin, `PLL_ENA`, which is not included in this pin count.
- (4) The total number of usable M4K blocks is limited to 768 to allow migration compatibility when prototyping with an EP2S180 device.

I/O Support and Planning

HardCopy II companion devices offer pin-to-pin compatibility with the Stratix II prototype device, which makes them drop-in replacements for the FPGAs. Therefore, you can use HardCopy II devices with the same system board and software developed for prototyping and field trials, enabling the fastest time-to market for high-volume production.

HardCopy II devices offer up to 951 user I/O pins. Table 8–4 lists all available I/O pin counts when assigning a Stratix II device while selecting a HardCopy II companion device. If a Stratix II design uses I/O pins that are not available in both the Stratix II device and the HardCopy II companion device, the Quartus II software issues a no-fit error. Therefore, it is important to monitor pin assignments based on the Stratix II device and the HardCopy II companion device.

Table 8–4. Package Options and I/O Pin Counts for Stratix II and HardCopy II Companion Devices Notes (1), (2)

Stratix II Device	HC210	HC220		HC230 (3)	HC240 (4)	
	484-Pin FineLine BGA	672-Pin FineLine BGA	780-Pin FineLine BGA	1,020-Pin FineLine BGA	1,020-Pin FineLine BGA	1,508-Pin FineLine BGA
EP2S30	334					
EP2S60	334	492				
EP2S90	308		494	698		
EP2S130			494	698		
EP2S180				698	742	951

Notes to Table 8–4:

- (1) User I/O pin counts are preliminary. The Quartus II software I/O pin counts include one additional pin, PLL_ENA, which is not included in this pin count. The PLL_ENA pin is not available as a general purpose I/O pin and can only be used to enable the PLLs in this device.
- (2) All I/O pin counts include eight dedicated clock input pins (clk1p, clk1n, clk3p, clk3n, clk9p, clk9n, clk11p, and clk11n) that can be used for data inputs.
- (3) The I/O pin counts for all HC230 combinations include four dedicated fast PLL clock inputs (FPLL7CLKp/n, FPLL8CLKp/n) that can be used for data inputs.
- (4) The I/O pin counts for HC240 combinations include eight dedicated fast PLL clock inputs (FPLL7CLKp/n, FPLL8CLKp/n, FPLL9CLKp/n, and FPLL10CLKp/n) that can be used for data inputs.

HardCopy II devices offer three distinct types of I/O elements (IOEs) which support a variety of I/O features to match Stratix II IOEs. These are memory interface IOEs, high-speed IOEs, and general purpose IOEs.

Memory interface IOEs support popular I/O standards used by external memory devices, including single-ended standards from LVTTTL, LVCMOS to SSTL, and HSTL voltage referenced (V_{REF}) type I/O standards. Memory interface IOEs also have PCI clamp circuitry for PCI support.

High-speed IOEs support differential applications utilizing LVDS and HyperTransport technology. High-speed IOEs also support single-ended LVTTTL and LVCMOS I/O standards, but do not support V_{REF} I/O standards.

General purpose IOEs support LVTTTL and LVCMOS I/O standards. General purpose IOEs on the bottom I/O banks (banks 7 and 8) also have PCI clamping circuitry to support the PCI interface on HardCopy II devices.



For more information on HardCopy II IOEs, refer to the *HardCopy II Description, Architecture, and Features* chapter of the *HardCopy Series Handbook*.

HardCopy II I/O Banks

HardCopy II devices have eight general I/O banks and up to four enhanced PLL external clock output banks (banks 9, 10, 11, 12). HC210 and HC220 devices only have PLL output banks 9 and 10. [Figure 8-1](#) shows the HardCopy II I/O banks and the relative PLL positions.

The left side I/O banks 1 and 2 are high speed IOE banks on all HardCopy II devices. The right side I/O banks 5 and 6 are general purpose IOEs on HC210, HC220, and HC230 devices, but high speed IOEs on HC240 devices.

The top I/O banks 3 and 4 are memory interface IOEs on all HardCopy II devices. The bottom I/O banks 7 and 8 are general purpose IOEs on HC210 and HC220 but memory interface IOEs on HC230 and HC240 devices. The general purpose IOEs on the bottom of the device support PCI clamping, but the general purpose IOEs on the right side do not.

Figure 8–1. HardCopy II HC240 I/O Banks Notes (1), (2), (3), (4)

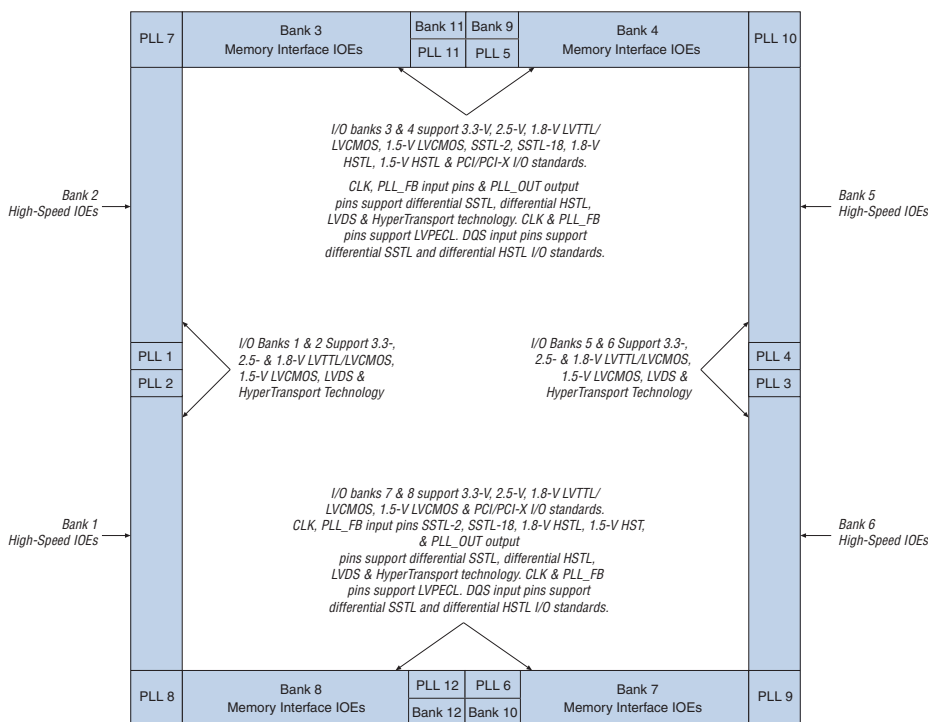

Notes to Figure 8–1:

- (1) Figure 8–1 is a top view of the silicon die that corresponds to a reverse view for flip-chip packages. It is a graphical representation only. Refer to the pin list and Quartus II software for exact locations.
- (2) Differential HSTL and differential SSTL standards are available for bidirectional operations on DQS pin and input only operations on PLL clock input pins; LVDS, LVPECL, and HyperTransport standards are available for input only operations on PLL clock input pins. Refer to “Differential I/O Termination” on page 8–20 for more details.
- (3) HardCopy II devices and the Quartus II software does not support differential SSTL and differential HSTL standards at left and right I/O banks. Side I/O banks do not have V_{REF} pins.
- (4) Figure 8–1 shows the HC240 device. Other HardCopy II devices have fewer PLL blocks.

User I/O Count Per IOE Type and Bank Location

Table 8–5 lists the maximum I/O count per IOE type. This helps you select a HardCopy II device based on the I/O standard support requirement.

Device	Package	Memory Interface IOEs		General Purpose IOEs		High-Speed IOEs	
		Top	Bottom	Right	Bottom	Left	Right
HC210	484-pin FineLine BGA	87		84	79	84	
HC220	672-pin FineLine BGA	126		124	118	124	
HC220	780-pin FineLine BGA	126		124	120	124	
HC230 (3)	1,020-pin FineLine BGA	180	178	152		188	
HC240 (4)	1,020-pin FineLine BGA	184	182			188	188
HC240 (4)	1,508-pin FineLine BGA	238	233			240	240

Notes to Table 8–5:

- (1) User I/O pin counts are preliminary. The Quartus II software I/O pin counts include one additional pin, `PLL_ENA`, which is not included in this pin count. The `PLL_ENA` pin is not available as a general purpose I/O pin and can only be used to enable the PLLs in this device.
- (2) All I/O pin counts include eight dedicated clock input pins (`clk1p`, `clk1n`, `clk3p`, `clk3n`, `clk9p`, `clk9n`, `clk11p`, and `clk11n`) that can be used for data inputs.
- (3) The I/O pin counts for all HC230 combinations include four dedicated fast PLL clock inputs (`FPLL7CLKp/n`, `FPLL8CLKp/n`) that can be used for data inputs.
- (4) The I/O pin counts for HC240 combinations include eight dedicated fast PLL clock inputs (`FPLL7CLKp/n`, `FPLL8CLKp/n`, `FPLL9CLKp/n`, and `FPLL10CLKp/n`) that can be used for data inputs.

HardCopy II Supported I/O Standards

Table 8–6 lists I/O standards that HardCopy II devices support, separated by IOE type. This list only focuses on user I/O pins.

I/O Standard	Type	V_{CCIO} Level (V)		Memory Interface IOEs	General Purpose IOEs	High-Speed IOEs
		Input	Output			
3.3-V LVTTTL/LVCMOS	Single-ended	3.3/2.5	3.3	✓	✓	✓
2.5-V LVTTTL/LVCMOS	Single-ended	3.3/2.5	2.5	✓	✓	✓
1.8-V LVTTTL/LVCMOS	Single-ended	1.8/1.5	1.8	✓	✓	✓
1.5-V LVCMOS	Single-ended	1.8/1.5	1.5	✓	✓	✓

Table 8–6. Hardcopy II Supported I/O Standards on User I/O Pins (Part 2 of 2)

I/O Standard	Type	V _{CCIO} Level (V)		Memory Interface IOEs	General Purpose IOEs	High-Speed IOEs
		Input	Output			
SSTL-2 class I and II	Voltage referenced	2.5	2.5	✓		
SSTL-18 class I and II	Voltage referenced	1.8	1.8	✓		
1.8-V HSTL class I and II	Voltage referenced	1.8	1.8	✓		
1.5-V HSTL class I and II	Voltage referenced	1.5	1.5	✓		
PCI / PCI-X	Single-ended	3.3	3.3	✓	(1)	
Differential SSTL-2 class I and II input	Pseudo differential (3)	3.3/2.5/ 1.8/1.5		(2)		
Differential SSTL-2 class I and II output	Pseudo differential (3)		2.5	(2)		
Differential SSTL-18 class I and II input	Pseudo differential (3)	3.3/2.5/ 1.8/1.5		(2)		
Differential SSTL-18 class I and II output	Pseudo differential (3)		1.8	(2)		
1.8-V differential HSTL class I and II input	Pseudo differential (3)	3.3/2.5/ 1.8/1.5			1.8/1.5	(2)
1.8-V differential HSTL class I and II output	Pseudo differential (3)		1.8	(2)		
1.5-V differential HSTL class I and II input	Pseudo differential (3)	3.3/2.5/ 1.8/1.5		(2)		
1.5-V differential HSTL class I and II output	Pseudo differential (3)		1.5	(2)		
LVDS	Differential	2.5	2.5			✓
HyperTransport™ technology	Differential	2.5	2.5			✓

Notes to Table 8–6:

- (1) Like Stratix II devices, the optional PCI clamp is only available on column I/O pins. General purpose IOEs on the right row I/O pins do not support the PCI clamp.
- (2) Similar to Stratix II devices, these I/O standards are only available on input clock pins, output clock pins in I/O banks 9, 10, 11, 12, and DQS pins in top I/O banks 3, 4 for all HardCopy II devices, and DQS pins in bottom I/O banks 7 and 8 for HC230 and HC240 devices.
- (3) Pseudo-differential HSTL and SSTL inputs only use the positive polarity input in the speed path. The negative input is not connected internally. Pseudo-differential HSTL and SSTL outputs use two single-ended outputs with the second output programmed as inverted. This is similar to a Stratix II device implementation.

Table 8-7 lists the I/O standards that HardCopy II devices support. Table 8-7 is organized by clock input, clock output, and PLL feedback pins.

I/O Standard	Type	V _{CCIO} Level (V)		CLK[0..3, 8..11] (1)	CLK[4..7, 12..15] (2)	FPLL_CLK (3)	PLL_OUT (4)	PLL_FB (5)
		Input	Output					
3.3-V LVTTTL / LVCMOS	Single-ended	3.3/2.5	3.3	✓	✓	✓	✓	✓
2.5-V LVTTTL / LVCMOS	Single-ended	3.3/2.5	2.5	✓	✓	✓	✓	✓
1.8-V LVTTTL / LVCMOS	Single-ended	1.8/1.5	1.8	✓	✓	✓	✓	✓
1.5-V LVCMOS	Single-ended	1.8/1.5	1.5	✓	✓	✓	✓	✓
SSTL-2 class I	Voltage referenced	2.5	2.5		✓		✓	✓
SSTL-2 class II	Voltage referenced	2.5	2.5		✓		✓	✓
SSTL-18 class I	Voltage referenced	1.8	1.8		✓		✓	✓
SSTL-18 class II	Voltage referenced	1.8	1.8		✓		✓	✓
1.8-V HSTL class I	Voltage referenced	1.8	1.8		✓		✓	✓
1.8-V HSTL class II	Voltage referenced	1.8	1.8		✓		✓	✓
1.5-V HSTL class I	Voltage referenced	1.5	1.5		✓		✓	✓
1.5-V HSTL class II	Voltage referenced	1.5	1.5		✓		✓	✓
PCI / PCI-X	Single-ended	3.3	3.3		✓		✓	✓
Differential SSTL-2 class I and II input	Pseudo differential (6)	3.3/2.5/ 1.8/1.5			✓			✓
Differential SSTL-2 class I and II output	Pseudo differential (6)		2.5				✓	✓
Differential SSTL-18 class I and II input	Pseudo differential (6)	3.3/2.5/ 1.8/1.5			✓			✓

Table 8–7. Hardcopy II Supported I/O Standards of Input Clocks, Clock Out, and PLL Feedback (Part 2 of 2)

I/O Standard	Type	V _{CCIO} Level (V)		CLK[0..3, 8..11] (1)	CLK[4..7, 12..15] (2)	FPLL_CLK (3)	PLL_OUT (4)	PLL_FB (5)
		Input	Output					
Differential SSTL-18 class I and II output	Pseudo differential (6)		1.8				✓	✓
1.8-V differential HSTL class I and II input	Pseudo differential (6)	3.3/2.5/ 1.8/1.5			✓			✓
1.8-V differential HSTL class I and II output	Pseudo differential (6)		1.8				✓	✓
1.5-V differential HSTL class I and II input	Pseudo differential (6)	3.3/2.5/ 1.8/1.5			✓			✓
1.5-V differential HSTL class I and II output	Pseudo differential (6)		1.5				✓	✓
LVDS input	Differential	2.5		✓	✓	✓		✓
LVDS output	Differential		2.5				✓	✓
HyperTransport technology input	Differential	2.5		✓	✓	✓		✓
HyperTransport technology output	Differential		2.5V				✓	✓
LVPECL input	Differential	3.3/2.5/ 1.8/1.5	(7)		✓		✓	✓

Notes to Table 8–7:

- (1) CLK8 and CLK10 pins on HC210, HC220, and HC230 devices do not support differential standards LVDS and HyperTransport technology. Only LVTTTL is supported on these CLK pins for these devices.
- (2) CLK[4..7] pins on HC210 and HC220 devices do not support SSTL, HSTL, differential SSTL, and HSTL input or output.
- (3) HC230 only has two fast PLL clocks, FPLL[7..8]CLK. HC240 has four FPLL clocks, FPLL[7..10]CLK.
- (4) HC210 and HC220 PLL6_OUT pins do not support SSTL, HSTL, differential SSTL, and HSTL input or output.
- (5) HC210 and HC220 PLL6_FB pins do not support SSTL, HSTL, differential SSTL, and HSTL input or output.
- (6) Pseudo-differential HSTL and SSTL inputs only use the positive polarity input in the speed path. The negative input is not connected internally. Pseudo-differential HSTL and SSTL outputs use two single-ended outputs with the second output programmed as inverted. This is similar to a Stratix II device implementation.
- (7) This is not supported.

External Memory Interface Support

Like Stratix II devices, HardCopy II I/O pins have dedicated phase-shift circuitry for interfacing with external memory, including DDR and DDR2 SDRAM, QDR II SRAM, RLDRAM II, and SDR SDRAM. A compensated delay element on each DQS pin automatically aligns input DQS synchronization signals with the data window of their corresponding DQ data signals.

For all HardCopy II devices, the top I/O banks (3 and 4) support DQ and DQS signals with DQ bus modes that vary from $\times 4$, $\times 8/\times 9$, $\times 16/\times 18$ and up to $\times 32/\times 36$. The top bank has a phase-shifting reference circuit that controls the compensated delay elements for all DQS pins on the top bank.

For the HC230 and HC240 HardCopy II devices, the bottom I/O banks (7 and 8) also support DQ and DQS signals with DQ bus modes from $\times 4$, $\times 8/\times 9$, $\times 16/\times 18$ and $\times 32/\times 36$. Similar to the top banks, the bottom I/O banks of these devices also have a phase-shifting reference circuit to control the delay elements at the bottom DQS pins.

Table 8–8 shows the number of DQ and DQS buses supported per companion device pair. (3)

Table 8–8. DQ and DQS Bus Mode support for Stratix II and HardCopy II Companion Devices (Part 1 of 2)
Note (1)

Stratix II and HardCopy II Companion Devices	Package	Number of $\times 4$ Groups	Number of $\times 8/\times 9$ Groups	Number of $\times 16/\times 18$ Groups	Number of $\times 32/\times 36$ Groups
EP2S30 HC210 (2)	484-pin FineLine BGA	4	2		
EP2S60 HC210 (2)	484-pin FineLine BGA	4	2		
EP2S90 HC210 (2)	484-pin FineLine BGA	4	2		
EP2S60 HC220 (2)	672-pin FineLine BGA	9	4	2	
EP2S90 HC220 (2)	780-pin FineLine BGA	9	4	2	
EP2S130 HC220 (2)	780-pin FineLine BGA	9	4	2	
EP2S90 HC230 (3)	1,020-pin FineLine BGA	36	18	8	4
EP2S130 HC230 (3)	1,020-pin FineLine BGA	36	18	8	4

Table 8–8. DQ and DQS Bus Mode support for Stratix II and HardCopy II Companion Devices (Part 2 of 2)
Note (1)

Stratix II and HardCopy II Companion Devices	Package	Number of ×4 Groups	Number of ×8/×9 Groups	Number of ×16/×18 Groups	Number of ×32/×36 Groups
EP2S180 HC230 (3)	1,020-pin FineLine BGA	36	18	8	4
EP2S180 HC240	1,020-pin FineLine BGA	36	18	8	4
EP2S180 HC240	1,508-pin FineLine BGA	36	18	8	4

Notes to Table 8–8:

- (1) The DQ and DQS numbers are preliminary.
- (2) HardCopy II devices HC210 and HC220 support memory interface in the top I/O banks only. Unlike their Stratix II companions, these devices cannot support DIMMs.
- (3) Similar to their Stratix II companions, these device and package combinations can support two 64- or 72-bit DIMMs in ×4 and ×8/×9 modes.

LVDS, SERDES, and DPA Compatibility

HardCopy II devices offer up to 116 transmitter and receiver pairs. Similar to Stratix II devices, these differential I/O pins are located on row I/O pins. The HC240 device's left and right banks are high-speed IOEs which support differential transmission. The HC210, HC220, and HC230 devices only support differential transmission on the left banks. The LVDS and HyperTransport technology interface functionality, including the SERDES and DPA, is the same as Stratix II devices.

Table 8–9 shows the maximum differential channel supported by each HardCopy II and Stratix II companion pair.

Table 8–9. Differential Channels with Stratix II and HardCopy II Companion Devices (Part 1 of 2) *Note (1)*

Stratix II and HardCopy II Companion Devices	Package	Transmitters	Receivers
EP2S30 HC210 (2)	484-pin FineLine BGA	19	21
EP2S60 HC210 (2)	484-pin FineLine BGA	19	21
EP2S90 HC210 (2)	484-pin FineLine BGA	19	21

Table 8–9. Differential Channels with Stratix II and HardCopy II Companion Devices (Part 2 of 2) *Note (1)*

Stratix II and HardCopy II Companion Devices	Package	Transmitters	Receivers
EP2S60 HC220 (2)	672-pin FineLine BGA	29	31
EP2S90 HC220 (2)	780-pin FineLine BGA	29	31
EP2S130 HC220 (2)	780-pin FineLine BGA	29	31
EP2S90 HC230 (2)	1,020-pin FineLine BGA	44	46
EP2S130 HC230 (2)	1,020-pin FineLine BGA	44	46
EP2S180 HC230 (2)	1,020-pin FineLine BGA	44	46
EP2S180 HC240 (3)	1,020-pin FineLine BGA	88	92
EP2S180 HC240 (3)	1,508-pin FineLine BGA	116	116

Notes to Table 8–9:

- (1) Pin count does not include dedicated PLL input and output pins.
- (2) The total number of receiver channels for HC210, HC220, and HC230 devices include two non-dedicated clock channels that can optionally be used as data channels.
- (3) The total number of receiver channels for HC240 devices include four non-dedicated clock channels that can optionally be used as data channels.

Programmable Drive Strength Support

The maximum current strength setting is the default setting in the Quartus II software and achieves maximum I/O performance. Stratix II device output buffers for each I/O pin have a programmable drive strength control for certain I/O standards.

HardCopy II support for these settings differs from that found in Stratix II devices. For compatibility with HardCopy II HC210 and HC220 devices, you must restrict the I/O drive settings of Stratix II companion devices, as shown in [Table 8–10](#).

Table 8–10. HC210 and HC220 Device Programmable Drive Strengths

I/O Standard	I _{OH} and I _{OL} Current Strength Setting (mA) for Top Column I/O Pins	I _{OH} and I _{OL} Current Strength Setting (mA) for Bottom Column I/O Pins	I _{OH} and I _{OL} Current Strength Setting (mA) for Left Row I/O Pins	I _{OH} and I _{OL} Current Strength Setting (mA) for Right Row I/O Pins
3.3-V LVTTTL	24, 20, 12, 8, 4 (1)	12, 8, 4 (1)	12, 8, 4	12, 8, 4
3.3-V LVCMOS	24, 20, 12, 8, 4 (1)	8, 4 (1)	8, 4	8, 4
2.5-V LVTTTL/LVCMOS	16, 12, 8, 4	12, 8, 4 (1)	12, 8, 4	12, 8, 4
1.8-V LVTTTL/LVCMOS	12, 10, 8, 6, 4, 2	8, 6, 4, 2 (1)	8, 6, 4, 2	8, 6, 4, 2
1.5-V LVCMOS	8, 6, 4, 2	4, 2 (1)	4, 2	4, 2
SSTL-2 class I	12, 8	(2)	(3)	(3)
SSTL-2 class II	24, 20, 16	(2)	(3)	(3)
SSTL-18 class I	12, 10, 8, 6, 4	(2)	(3)	(3)
SSTL-18 class II	20, 18, 16, 8	(2)	-	-
HSTL-18 class I	12, 10, 8, 6, 4	(2)	-	-
HSTL-18 class II	20, 18, 16	(2)	-	-
HSTL-15 class I	12, 10, 8, 6, 4	(2)	-	-
HSTL-15 class II	20, 18, 16	(2)	-	-

Notes to Table 8–10:

- (1) HardCopy II devices do not support some of the settings available in the Stratix II prototype device. For more information, refer to the *Stratix II Device Family Data Sheet* in volume 1 of the *Stratix II Device Handbook*.
- (2) HC220 and HC210 devices do not support memory interface standards on bottom I/O pins.
- (3) Row I/O pins do not support SSTL I/O standards.

Similarly, when using HardCopy II HC230 and HC240 devices as companion devices, you must restrict the I/O drive settings, as shown in [Table 8–11](#).

Table 8–11. HC230 and HC240 Device Programmable Drive Strengths

I/O Standard	I_{OH} and I_{OL} Current Strength Setting (mA) for Column I/O Pins	I_{OH} and I_{OL} Current Strength Setting (mA) for Row I/O Pins
3.3-V LVTTTL	24, 20, 16, 12, 8, 4 (1)	12, 8, 4
3.3-V LVCMOS	24, 20, 16, 12, 8, 4 (1)	8, 4
2.5-V LVTTTL/LVCMOS	16, 12, 8, 4	12, 8, 4
1.8-V LVTTTL/LVCMOS	12, 10, 8, 6, 4, 2	8, 6, 4, 2
1.5-V LVCMOS	8, 6, 4, 2	4, 2
SSTL-2 class I	12, 8	(2)
SSTL-2 class II	24, 20, 16	(2)
SSTL-18 class I	12, 10, 8, 6, 4	(2)
SSTL-18 class II	20, 18, 16, 8	-
HSTL-18 class I	12, 10, 8, 6, 4	-
HSTL-18 class II	20, 18, 16	-
HSTL-15 class I	12, 10, 8, 6, 4	-
HSTL-15 class II	20, 18, 16	-

Notes to Table 8–11:

- (1) HardCopy II devices do not support some of the settings available in the Stratix II prototype device. For more information, refer to the *Stratix II Device Family Data Sheet* in volume 1 of the *Stratix II Device Handbook*.
- (2) Row I/O pins do not support SSTL I/O standards.

On-Chip Termination

Like Stratix II devices, HardCopy II devices feature on-chip termination (OCT) to provide I/O impedance matching and termination capabilities. To maintain compatibility with Stratix II prototype devices, HardCopy II devices support on-chip series termination (RS) for single-ended I/O standards and on-chip differential termination (RD) for differential I/O standards. However, some HardCopy II pins do not support the on-chip termination that may be available on the same Stratix II pin. This section highlights the termination schemes that HardCopy II devices support.

On-Chip Series Termination

Stratix II and HardCopy II devices support I/O driver on-chip series termination (RS) through drive-strength control for single-ended I/O standards. There are two ways to implement the RS in Stratix II and Hardcopy II devices:

- RS without calibration for both row and column I/O pins
- RS with calibration only for column I/O pins

On-Chip Series Termination without Calibration

HardCopy II devices support output-driver impedance matching to closely match the impedance of the transmission line. If you select matching impedance, you cannot select programmable-current drive strength. Table 8–12 lists the HardCopy II HC230 and HC240 output standards that support on-chip series termination without calibration.

Table 8–12. HC230 and HC240 Selectable I/O Drivers with On-Chip Series Termination without Calibration *Note (1)*

I/O Standard	Column I/O Pins	Row I/O Pins
3.3-V LVTTTL	25 or 50 Ω	25 or 50 Ω
3.3-V LVCMOS	25 or 50 Ω	25 or 50 Ω
2.5-V LVTTTL	25 or 50 Ω	25 or 50 Ω
2.5-V LVCMOS	25 or 50 Ω	25 or 50 Ω
1.8-V LVTTTL	25 or 50 Ω	50 Ω
1.8-V LVCMOS	25 or 50 Ω	50 Ω
1.5-V LVTTTL	50 Ω	
1.5-V LVCMOS	50 Ω	
2.5-V SSTL class I	50 Ω	(2)
2.5-V SSTL class II	25 Ω	(2)
1.8-V SSTL class I	50 Ω	(2)
1.8-V SSTL class II	25 Ω	
1.8-V HSTL class I	50 Ω	(2)
1.8-V HSTL class II	25 Ω	
1.5-V HSTL class I	(3)	

Notes to Table 8–12:

- (1) These numbers are preliminary and pending silicon characterization.
- (2) HardCopy II HC230 and HC240 devices do not support on-chip series termination with this I/O standard on these pins.
- (3) Support pending HardCopy II characterization.

Table 8–13 lists the HardCopy II HC210 and HC220 output standards that support on-chip series termination without calibration.

Table 8–13. HC210 and HC220 Selectable I/O Drivers with On-Chip Series Termination without Calibration
Note (1)

I/O Standard	Top Column I/O Pins	Bottom Column I/O Pins	Left Row I/O Pins	Right Row I/O Pins
3.3-V LVTTTL	25 or 50 Ω	25 or 50 Ω	25 or 50 Ω	25 or 50 Ω
3.3-V LVCMOS	25 or 50 Ω	25 or 50 Ω	25 or 50 Ω	25 or 50 Ω
2.5-V LVTTTL	25 or 50 Ω	25 or 50 Ω	25 or 50 Ω	25 or 50 Ω
2.5-V LVCMOS	25 or 50 Ω	25 or 50 Ω	25 or 50 Ω	25 or 50 Ω
1.8-V LVTTTL	25 or 50 Ω	50 Ω	50 Ω	50 Ω
1.8-V LVCMOS	25 or 50 Ω	50 Ω	50 Ω	50 Ω
1.5-V LVTTTL	(3)	(2)		
1.5-V LVCMOS	(3)	(2)		
2.5-V SSTL class I	50 Ω	(2)	(2)	(2)
2.5-V SSTL class II	25 Ω	(2)	(2)	(2)
1.8-V SSTL class I	50 Ω	(2)	(2)	(2)
1.8-V SSTL class II	25 Ω	(2)		
1.8-V HSTL class I	50 Ω	(2)	(2)	(2)
1.8-V HSTL class II	25 Ω	(2)		
1.5-V HSTL class I	(3)	(2)		

Notes to Table 8–13:

- (1) All these numbers are preliminary and pending silicon characterization.
- (2) HardCopy II HC210 and HC220 devices do not support on-chip series termination with this I/O standard on these pins.
- (3) Support pending HardCopy II characterization.

On-Chip Series Termination with Calibration

Stratix II devices support on-chip series termination with calibration in column I/O pins in the top and bottom banks. HC230 and HC240 devices also support on-chip series termination with calibration in column I/O pins in the top and bottom banks, but HC220 and HC210 devices only support this feature on the top I/O banks. Table 8–14 lists available I/O standards on the HardCopy II devices that support calibrated-series termination.

Table 8–14. HardCopy II Selectable I/O Drivers with On-Chip Series Termination with Calibration <i>Note (1)</i>		
I/O Standard	HC230, HC240 Column I/O Pins	HC210, HC220 Top Column I/O Pins (2)
3.3-V LVTTTL	25 or 50 Ω	25 or 50 Ω
3.3-V LVCMOS	25 or 50 Ω	25 or 50 Ω
2.5-V LVTTTL	25 or 50 Ω	25 or 50 Ω
2.5-V LVCMOS	25 or 50 Ω	25 or 50 Ω
1.8-V LVTTTL	25 or 50 Ω	25 or 50 Ω
1.8-V LVCMOS	25 or 50 Ω	25 or 50 Ω
1.5-V LVTTTL	(3)	50 Ω
1.5-V LVCMOS	(3)	50 Ω
2.5-V SSTL class I	50 Ω	50 Ω
2.5-V SSTL class II	25 Ω	50 Ω
1.8-V SSTL class I	50 Ω	50 Ω
1.8-V SSTL class II	25 Ω	25 Ω
1.8-V HSTL class I	50 Ω	50 Ω
1.8-V HSTL class II	25 Ω	25 Ω
1.5-V HSTL class I	(3)	50 Ω

Notes to Table 8–14:

- (1) These numbers are preliminary and pending silicon characterization.
- (2) HardCopy II HC210 and HC220 devices do not support on-chip series termination with calibration on bottom I/O pins.
- (3) Support pending HardCopy II characterization.

Differential I/O Termination

Similar to the FPGA, HardCopy II devices provide an on-chip 100- Ω differential termination option on each differential receiver channel for LVDS and HyperTransport technology standards. When using an HC240 device as a companion device, differential termination is supported on all row I/O pins that support LVDS and HyperTransport technology standards.

When using HC230, HC220, and HC210 devices, only the left row I/O pins support differential termination. The right row I/O pins do not support LVDS and HyperTransport technology standards.

Table 8–15 shows the differential termination support.

I/O Standard	HC240 Left and Right Banks (1, 2, 5 and 6)	HC240 Top and Bottom Banks (3, 4, 7 through 12)	HC230, HC210, HC220 Left Banks (1 and 2)	HC230, HC210, HC220 Other Banks (3 to 12)
LVDS	✓		✓	
HyperTransport technology	✓		✓	
Clock Inputs (3)	✓		✓	

Notes to Table 8–15:

- (1) HC230, HC220, and HC210 device left clock pins CLK0 and CLK2 support differential on-chip termination.
- (2) All other clock pins, including FPLL[7..10]CLK, do not support differential on-chip termination.
- (3) HardCopy II HC240 device clock pins CLK0, CLK2, CLK8, and CLK10 support differential on-chip termination, similar to Stratix II devices.

Stratix II and HardCopy II Companion Memory Blocks

HardCopy II device RAM bit offerings range from 663 kbits to 8.8 Mbits. HardCopy II memory blocks are functionally equivalent to the Stratix II memory blocks. HardCopy II memory blocks can implement various Stratix II device memory configurations, including simple and true dual port modes, FIFO, parity bits, ROM modes, and all other features, as listed in the *HardCopy II Description, Architecture, and Features* chapter of the *HardCopy Series Handbook*. One difference between HardCopy II and Stratix II devices is that HardCopy II devices do not support M512 blocks. Additionally, you cannot pre-load HardCopy II M4K blocks with a Memory Initialization File (.mif) when used as RAM.

Table 8–16 shows all the memory block offerings when compiling for a Stratix II FPGA in conjunction with a HardCopy II companion device. Use Table 8–16 as a guide when optimizing memory requirements for selected Stratix II and HardCopy II pairs.

Stratix II and HardCopy II Companion Devices	Package	M4K Blocks	M-RAM Blocks	Total RAM Bits
EP2S30 HC210	484-pin FineLine BGA	144	0	663,552
EP2S60 HC210	484-pin FineLine BGA	190	0	875,520

Table 8–16. Total RAM Blocks for Stratix II and HardCopy II Companion Devices (Part 2 of 2)

Stratix II and HardCopy II Companion Devices	Package	M4K Blocks	M-RAM Blocks	Total RAM Bits
EP2S90 HC210	484-pin FineLine BGA	190	0	875,520
EP2S60 HC220	672-pin FineLine BGA	255	2	2,354,688
EP2S90 HC220	780-pin FineLine BGA	408	2	3,059,712
EP2S130 HC220	780-pin FineLine BGA	408	2	3,059,712
EP2S90 HC230	1,020-pin FineLine BGA	408	4	4,239,360
EP2S130 HC230	1,020-pin FineLine BGA	609	6	6,345,216
EP2S180 HC230	1,020-pin FineLine BGA	614	6	6,368,256
EP2S180 HC240	1,020-pin FineLine BGA	768(1)	9	8,847,360
EP2S180 HC240	1,508-pin FineLine BGA	768(1)	9	8,847,360

Note to Table 8–16

- (1) The total number of usable M4K blocks is limited to 768 to allow migration compatibility when prototyping with an EP2S180 device.

Table 8–16 does not list M512 blocks because they are not supported in HardCopy II devices. Also, the HC210 devices do not offer M-RAM blocks. Some compatibility guidelines are discussed in the next sections.

M512 Options

HardCopy II devices do not support M512 blocks. When compiling Stratix II designs with Hardcopy II companions devices in the Quartus II software, you must check the **Limit DSP and RAM to HardCopy II Resources** box in the **Device Settings** dialog box (Assignments Menu). This automatically places all memory blocks in the available HardCopy II resources. If you do not check this box, the Quartus II software may use memory resources not available in the HardCopy II device but available in the Stratix II device, such as M512 blocks. However, migration into HardCopy II devices is not allowed and this is indicated in the Quartus II fitter report.

Your HardCopy II design can use M4K memory blocks to implement memory designs instead of M512 blocks. Quartus II megafunctions offer various memory implementations that use M4K blocks. When using the Quartus II MegaWizard® Plug-In Manager to configure the megafunction, Altera recommends selecting the **Auto** option to allow the Quartus II software to determine how the design is implemented in the memory blocks (Figure 8–2). This allows the Quartus II software to optimize memory selection based on memory size and placement requirements into the available memory blocks of the selected HardCopy II and Stratix II companion pair.

Figure 8–2. Quartus II MegaFunction RAM selection

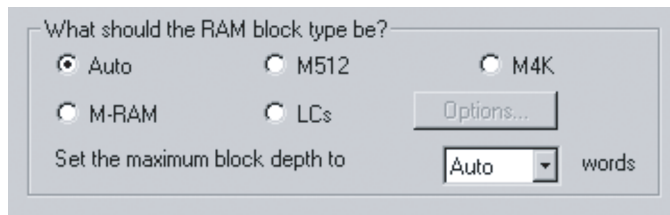

You can select logic cells in the megafunction to implement small-memory blocks in your design. This implements the memory design in Stratix II ALMs or HardCopy II HCells. However, there may be power and performance trade-offs when choosing between an M4K or M-RAM block or using the ALMs (or HCells). HardCopy II devices power down unused M4K blocks, M-RAM blocks, and HCells.

 Implementing memory blocks using logic cells, as seen in Figure 8–2, allows you to select a memory implementation functionally equivalent to M512 blocks or a non-equivalent option to save resources. Altera recommends setting the option to a functionally equivalent version with the M512 blocks.

For very small memory implementations such as a 8×16 single port RAM, the M4K or M-RAM blocks will be under-utilized, and may be less power efficient than a small number of HCells. If you select the logic cell option, only a fraction of ALMs are required in the Stratix II device, which translates into a small number HCells used in the HardCopy II device. However, when performance is a key factor, or your design requires ALMs to implement other logic, it may be more efficient to use M4K blocks. Altera recommends using the Quartus II software to analyze performance trade-offs between the given options.

M4K Utilization

HardCopy II M4K block functionality is similar to Stratix II M4K blocks. You cannot pre-load HardCopy II M4K blocks with a memory initialization file (.mif) when used as RAM. Also, unlike Stratix II devices, the HardCopy II M4K RAM contents and their output registers are unknown after power up. However, if the HardCopy II M4K block is designated as ROM, it powers up with the ROM contents. When designing M4K blocks as RAM, Altera recommends writing to the block before reading from it to avoid reading unknown initial power-up data conditions. One advantage over Stratix II RAM blocks is unused M4K blocks are disconnected from the power rails, optimizing overall power consumption.

M-RAM Compatibility

HardCopy II M-RAM blocks share the same functionality as Stratix II M-RAM blocks. One key feature with HardCopy II M-RAM blocks is power optimization when the M-RAM block is not used. Unused M-RAM blocks are disconnected from the power rails, optimizing overall power consumption.



Some Stratix II devices (engineering sample devices and Revision A production devices) have M-RAM functionality that differs slightly from current Stratix II production devices. HardCopy II M-RAM functionality only matches that of current Stratix II devices. Hence, in order to maintain proper compatibility, compiling only for current production Stratix II devices is supported. More information on the Stratix II M-RAM errata can be found in the *Stratix II FPGA Family Errata Sheet* available on the Altera website (www.altera.com).

Table 8–17 lists the M4K and M-RAM block supported features. This information can also be found in the *HardCopy II Description, Architecture, and Features* chapter of the *HardCopy Series Handbook*.

Feature	M4K Blocks	M-RAM Blocks
Total RAM bits (including parity bits)	4,608	589,824
Configurations	4K × 1 2K × 2 1K × 4 512 × 8 512 × 9 256 × 16 256 × 18 128 × 32 128 × 36	64K × 8 64K × 9 32K × 16 32K × 18 16K × 32 16K × 36 8K × 64 8K × 72 4K × 128 4K × 144
Parity bits	✓	✓
Byte enable	✓	✓
Pack mode	✓	✓
Address clock enable	✓	✓
Single-port memory	✓	✓
Simple dual-port memory	✓	✓
True dual-port memory	✓	✓
Embedded shift register	✓	—
ROM	✓	—
FIFO buffer	✓	✓
Simple dual-port mixed width support	✓	✓
True dual-port mixed width support	✓	✓
Memory initialization file (.mif)	(1)	—
Mixed-clock mode	✓	✓
Power-up condition	Outputs unknown	Outputs unknown
Register clears	Output registers only	Output registers only
Same-port read-during-write	New data available at positive clock edge	New data available at positive clock edge

Feature	M4K Blocks	M-RAM Blocks
Mixed-port read-during-write	Outputs set to unknown or old data	Unknown output
Power down of unused RAM blocks (2)	✓	✓

Notes to Table 8–17:

- (1) Stratix II M4K blocks support .mif file loading.
- (2) Stratix II memory blocks remain powered up even when not used.

PLL Planning and Utilization

Stratix II devices support enhanced PLLs and fast PLLs. HardCopy II devices also support enhanced PLLs and fast PLLs, but with two variations:

- HardCopy II devices have a different number of PLLs than Stratix II devices.
- HardCopy II devices may support fewer I/O standards for clock inputs and outputs. This is explained in the I/O standards support section later in this chapter.

Table 8–18 shows which PLLs each HardCopy II and Stratix II device supports. The Stratix II reference columns are divided based on package, not density. Figures 8–3 to 8–5 show PLL number designations. The Stratix II devices support 6 or 12 PLLs depending on the package offering, and not the device density. The HardCopy II PLLs are not removed symmetrically from all four sides. In general, fast PLLs are removed from sides that do not support high speed IOEs since the primary use of the fast PLL on the sides is for high speed I/O interface functions.

Stratix II and HardCopy II Companion Devices	Package	Fast PLLs								Enhanced PLLs				
		1	2	3	4	7	8	9	10	5	6	11	12	
EP2S30 HC210 (1)	484-pin FineLine BGA	✓	✓								✓	✓		
EP2S60 HC210 (1)	484-pin FineLine BGA	✓	✓								✓	✓		
EP2S90 HC210 (1)	484-pin FineLine BGA	✓	✓								✓	✓		
EP2S60 HC220 (1)	672-pin FineLine BGA	✓	✓								✓	✓		

Table 8–18. Stratix II / HardCopy II Companion Device PLL Availability Guide (Part 2 of 2)

Stratix II and HardCopy II Companion Devices	Package	Fast PLLs								Enhanced PLLs				
		1	2	3	4	7	8	9	10	5	6	11	12	
EP2S90 HC220 (1)	780-pin FineLine BGA	✓	✓								✓	✓		
EP2S130 HC220 (1)	780-pin FineLine BGA	✓	✓								✓	✓		
EP2S90 HC230 (2)	1,020-pin FineLine BGA	✓	✓			✓	✓				✓	✓	✓	✓
EP2S130 HC230 (2)	1,020-pin FineLine BGA	✓	✓			✓	✓				✓	✓	✓	✓
EP2S180 HC230 (2)	1,020-pin FineLine BGA	✓	✓			✓	✓				✓	✓	✓	✓
EP2S180 HC240	1,020-pin FineLine BGA	✓	✓	✓	✓	✓	✓	✓	✓		✓	✓	✓	✓
EP2S180 HC240	1,508-pin FineLine BGA	✓	✓	✓	✓	✓	✓	✓	✓		✓	✓	✓	✓

Notes to Table 8–18:

- (1) HC210 and HC220 devices do not support fast PLLs 3, 4, 9, and 10, unlike Stratix II devices.
(2) HC230 devices do not support fast PLLs 3 and 4, unlike Stratix II devices.

HardCopy II PLLs are functionally identical to the Stratix II PLLs. The HardCopy II enhanced and fast PLLs support reconfiguration and are also reconfigurable for bandwidth and phase shift.

Figures 8–3 to 8–5 show the PLL locations for each HardCopy II device.

For HC210 and HC220 devices, fast PLLs 1 and 2 are located in the logic array of the device and enhanced PLLs 5 and 6 are located in the periphery next to the device's top and bottom I/O banks.

Figure 8–3. HC210 and HC220 PLL Locations

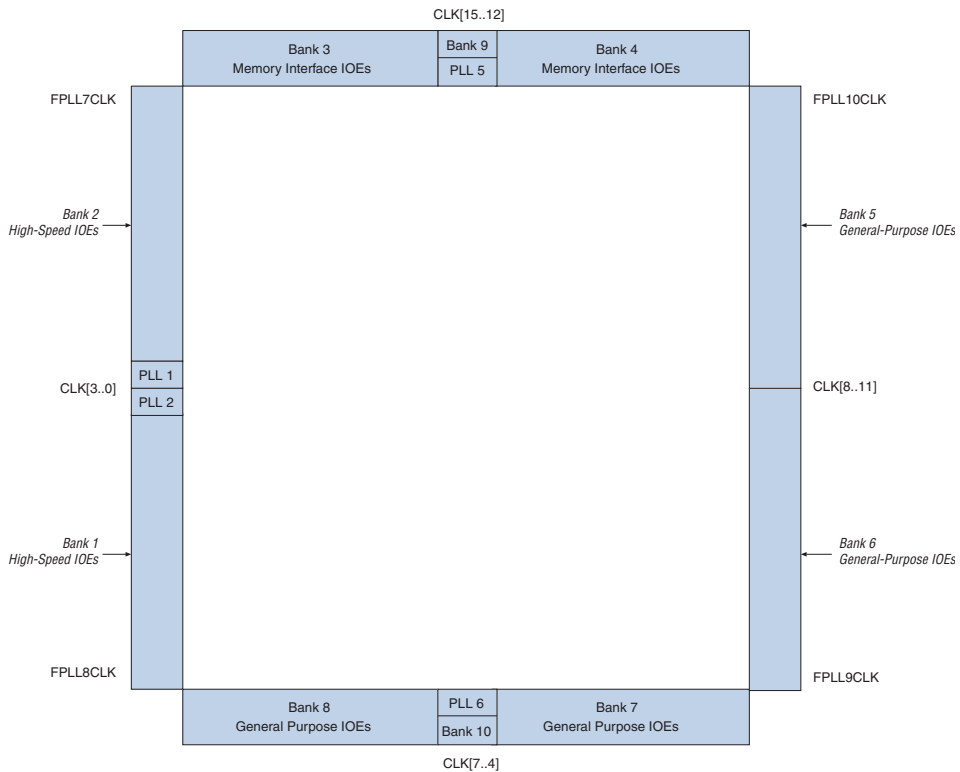

HC230 device fast PLLs 1, 2, 7, and 8 are located in the logic array, next to the device's left high-speed IOEs. HC230 device enhanced PLLs 5, 6, 11, and 12 are also located in the logic array, next to the top and bottom memory interface IOEs.

Figure 8–4. HC230 PLL Locations

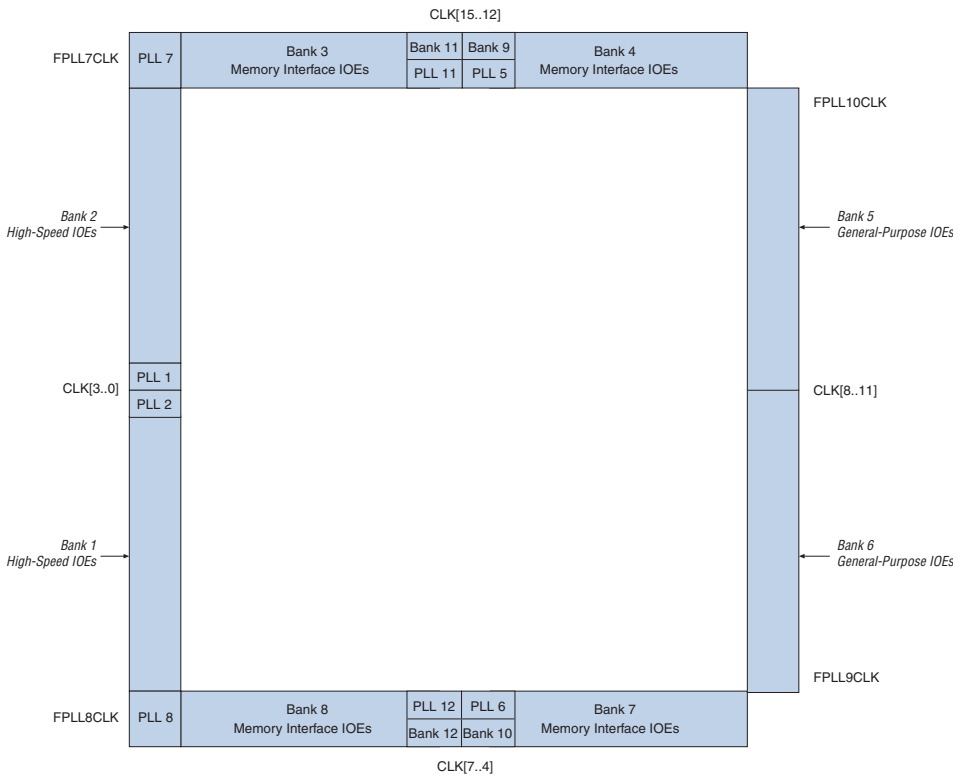

HC240 device fast PLLs 1, 2, 7, and 8 are located in the logic array, next to the left high speed IOEs of the device. HC240 device fast PLLs 3, 4, 9, and 10 are located in the logic array, next to the right high speed IOEs. HC240 device enhanced PLLs 5, 6, 11, and 12 are located in the logic array, next to the top and bottom memory interface IOEs.

Figure 8–5. HC240 PLL Locations

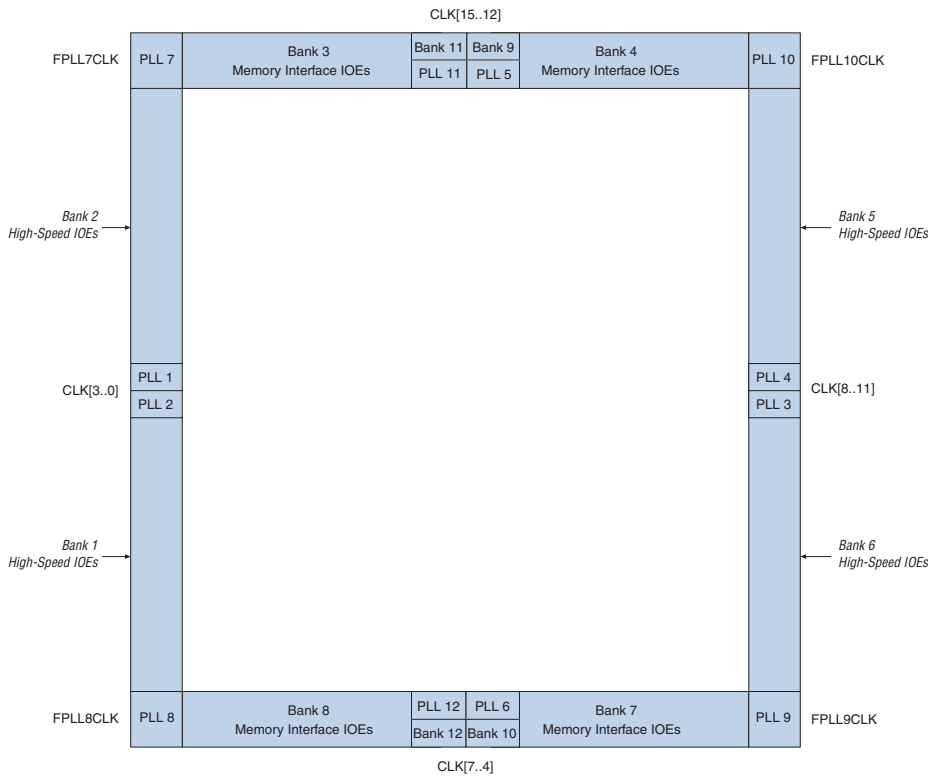

Global and Local Signals

HardCopy II devices have 16 clock pins ($CLK[15..0]$) to drive either the global or local clock networks. Four clock pins drive each side of the device. This is similar to Stratix II devices; therefore, there are no limitations when compiling designs for Stratix II devices and HardCopy II companion devices.

Internal logic and enhanced and fast PLL outputs can also drive the global and regional clock networks. Each global and regional clock network has a clock control block, which controls the selection of the clock source and allows you to dynamically enable or disable the clock network to reduce power consumption.

Table 8–19 lists the clock resources available in HardCopy II devices.

Table 8–19. Clock Network Resources and Features Available in HardCopy II Devices	
Resources and Features	Availability
Number of global clock networks	16
Number of regional clock networks	32
Global clock input sources	Clock input pins, PLL outputs, logic array
Regional clock input sources	Clock input pins, PLL outputs, logic array
Number of unique clock sources in a quadrant	24 (16 global clocks and 8 regional clocks)
Number of unique clock sources in the entire device	48 (16 global clocks and 32 regional clocks)
Power-down mode	Global and regional clock networks, dual-regional clock region
Clocking regions for high fan-out applications	Quadrant region, dual-regional, entire device via global or regional clock networks

Stratix II ALM Adaptation into HardCopy II Logic

The basic logic building block in the Stratix II architecture is the ALM. Each ALM contains a variety of look-up table- (LUT-) based resources, two programmable registers, two dedicated full adders, and various routing resources to and from the ALM.

HardCopy II devices do not have ALM blocks, but use a fine-grain architecture called HCells. HCells can implement all combinations of Stratix II ALM and DSP logic. Each HardCopy II companion device contains an abundance of HCells to implement a Stratix II design utilizing all available ALMs. Therefore, there are no compatibility constraints when compiling for HardCopy II devices.

When compiling a Stratix II design into a HardCopy II companion device, the Quartus II software replaces ALM blocks used in Stratix II with predefined HCell macros. Unused ALM resources are not implemented in HardCopy II devices. This allows for optimal placement of the HardCopy II floor plan and significant power savings.

Figure 8–6 shows an example of a Stratix II ALM block implementation using only one of the registers. When compiling this Stratix II design for a HardCopy II companion device, the Quartus II compiler replaces the

ALM block with a predetermined HCell macro that implements a register from its HardCopy II library of HCell macros. This macro entry has predetermined timing.

Figure 8–6. Stratix II ALM Simple Registered Input and Output

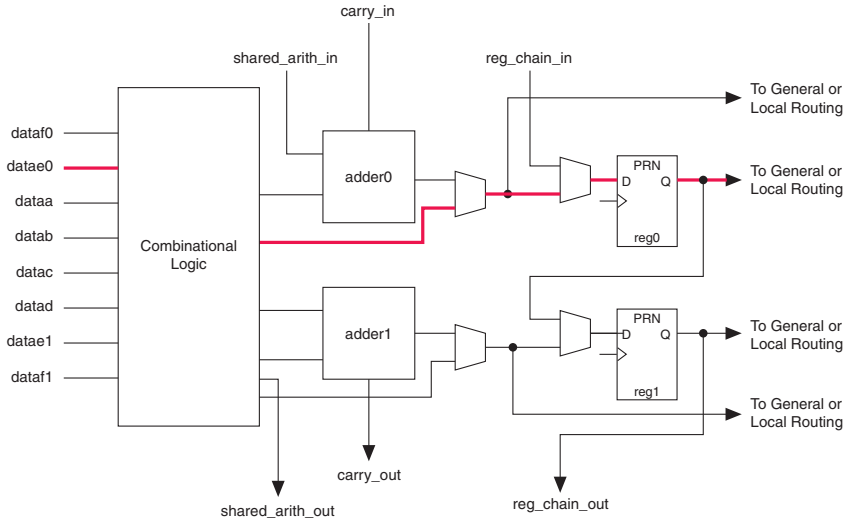
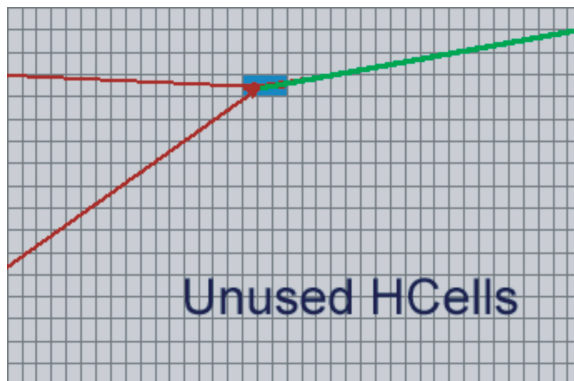

Figure 8–7 shows a HardCopy II ALM register implementation showing Clock, Data In, and Data Out originating from a small cluster of HCells. Unused HCells are reserved for other logic implementation or powered down.

Figure 8–7. HardCopy II Unused HCells



HardCopy II DSP Implementation from Stratix II DSP Blocks

Stratix II FPGAs have dedicated DSP blocks to implement various DSP functions. Stratix II DSP blocks consist of multipliers, an adder/subtractor/accumulator and a summation block, input and output interfaces, and input and output registers. The Quartus II software implements DSP functions in HardCopy II devices with HCells using predetermined logic implementations from its library of HCell macros, all of which have predetermined timing.

DSP blocks that are not used in the Stratix II design are not implemented in Hardcopy II devices. This preserves the HardCopy II logic for other implementations, saving resources and power. Furthermore, the HardCopy II DSP block placement can be optimized to meet the timing constraint requirements placed on the HardCopy II designs.

The HardCopy II DSP implementation is functionally equivalent to Stratix II DSP blocks and all features are supported except for dynamic-mode switching. You can set up Stratix II DSP blocks to dynamically switch between the following three modes:

- Up to four 18-bit independent multipliers
- Up to two 18-bit multiplier-accumulators
- One 36-bit multiplier

HardCopy II DSP implementation does not support dynamic switching. If this feature is used, the Quartus II software flags the DSP implementation and does not allow you to migrate the design. The fitter reports that all HardCopy II devices are not compatible with the design. To migrate your Stratix II design to a HardCopy II companion device, disable dynamic switching in the DSP blocks.

The total number of DSP blocks is dependent on the Stratix II device selected. HardCopy II devices will match the available DSP block resources in the Stratix II device. [Table 8-20](#) lists available DSP implementations based on the selected Stratix II device.

Table 8-20. DSP Multiplier Availability for Stratix II and HardCopy II Companion Devices (Part 1 of 2)

Stratix II Device	HC210			HC220			HC230			HC240		
	9 × 9	18 × 18	36 × 36	9 × 9	18 × 18	36 × 36	9 × 9	18 × 18	36 × 36	9 × 9	18 × 18	36 × 36
EP2S30	128	64	16									
EP2S60	288	144	36	288	144	36						
EP2S90 (1)	384	192	48	384	192	48	384	192	48			
EP2S130 (1)				504	252	63	504	252	63			

Table 8–20. DSP Multiplier Availability for Stratix II and HardCopy II Companion Devices (Part 2 of 2)

Stratix II Device	HC210			HC220			HC230			HC240		
	9 × 9	18 × 18	36 × 36	9 × 9	18 × 18	36 × 36	9 × 9	18 × 18	36 × 36	9 × 9	18 × 18	36 × 36
EP2S180 (1)							768	384	96	768	384	96

Note to Table 8–20:

- (1) If these Stratix II devices are selected with smaller HardCopy II companion devices, all Stratix II DSP resources may not be available if all the Stratix II ALM blocks are used and fully utilized. Quartus II will determine available resources for DSP and ALM implementation when compiling with HardCopy II devices.

Figure 8–8 shows an example of a Stratix II DSP block that uses only 1 of 8 available 9 × 9 multiplier blocks and an accumulator block to implement an 8 × 8 bit multiplication function with clock latency. When this DSP block is implemented in the HardCopy II design, the Quartus II Compiler chooses the appropriate entry from the macro library to implement the 9 × 9 multiplier and accumulator block which results in an optimized logic utilization and placement flexibility.

Figure 8–8. HardCopy II Floorplan of 8 × 8 DSP Block

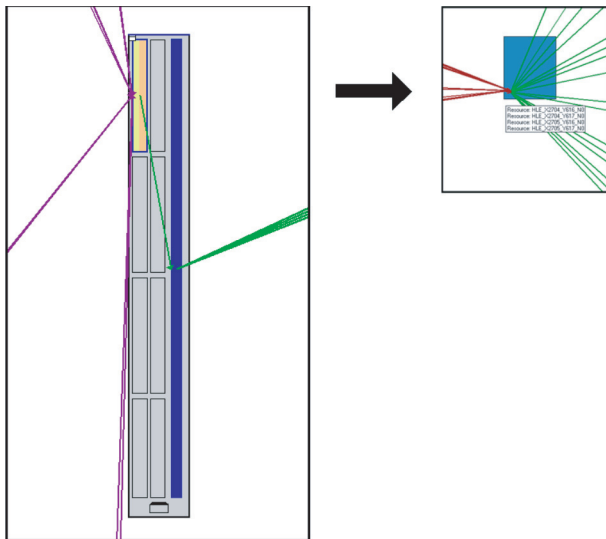
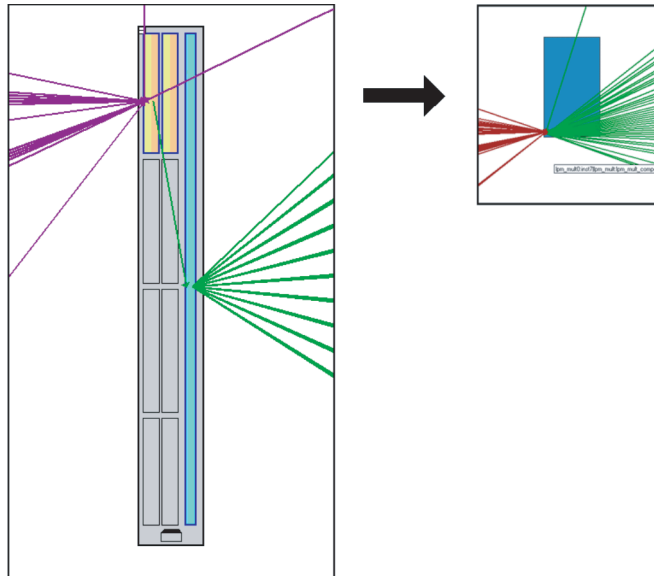

Figure 8–9 shows Quartus II floor plans of a Stratix II DSP block on the left and a HardCopy II DSP implementation on the right, both configured with an 18×18 multiply with accumulate function. In the HardCopy II implementation, the Quartus II software selected the appropriate DSP logic implementation from the macro library which results in an optimal utilization of the HardCopy II device's HCells. The unused sections of the Stratix II DSP block remain powered up, but these are not implemented in the HardCopy II device. Unused logic in HardCopy II devices are powered down.

Figure 8–9. HardCopy II Floorplan of 18×18 DSP Block



JTAG BST and Extended Functions

HardCopy II devices support the same boundary-scan test (BST) functionality as the Stratix II devices. However, since HardCopy II devices are mask-programmed, no reconfiguration is possible. Therefore, HardCopy II devices do not support instructions to reconfigure the device through the JTAG pins. For a list of supported features and instruction codes, refer to the *Boundary-Scan Support* chapter of the *HardCopy Series Handbook*.

One Stratix II feature utilizing JTAG pins is the Signal Tap II embedded logic analyzer (ELA). HardCopy II devices support the JTAG ELA feature. However, designing with this feature will use additional resources and may reduce peak performance in Stratix II and

HardCopy II devices. Unlike Stratix II devices, where this feature can be eliminated prior to compiling a final version of the design, HardCopy II devices are masked programmed and this feature will remain permanent in the HardCopy II device. Therefore, if the design requires optimal performance and resource utilization, Altera recommends using this feature on the Stratix II prototype device, but eliminating it prior to recompiling the design for a HardCopy II device.

Power Up and Configuration Compatibility

When designing a board with a Stratix II prototype device and its companion HardCopy II device, most configuration pins required by the Stratix II device are not required by the HardCopy II device. To maximize I/O pin counts with HardCopy II device utilization, Altera recommends minimizing power up and configuration pins that will not carry over from a Stratix II device into a HardCopy II device. Table 8–21 lists the dedicated and optional configuration pins that a Stratix II device can use and if their optional functionality is used on a HardCopy II device.

If the HardCopy II device can use the pin's optional function found in Stratix II devices, the Quartus II software allows you to set these pins as dual purpose pins. As dual purpose pins, they have I/O functionality after power up, reconfiguration and initialization. These pins will only switch to their I/O designation when the device enters user mode (when INIT_DONE is asserted). The design may require that some signals be present when the device transitions into user mode, so you should not use dual purpose pins because it may result in unstable operation after power up for both the HardCopy II and the Stratix II devices.

Table 8–21. Power Up and Configuration Pin Compatibility (Part 1 of 3)

Stratix II Pin Name		I/O Bank	HardCopy II Use	
Main Function	Optional Function		Main Function	Optional Function
MSEL3		B4		
MSEL2		B4		
MSEL1		B4		
MSEL0		B4		
VCCSEL		B8	✓	✓
nCONFIG		B8	✓	✓
nSTATUS		B3	✓	✓
CONF_DONE		B3	✓	✓
nCE		B3	✓	✓

Table 8–21. Power Up and Configuration Pin Compatibility (Part 2 of 3)

Stratix II Pin Name		I/O Bank	HardCopy II Use	
Main Function	Optional Function		Main Function	Optional Function
nCEO		B7	✓	✓
PORSEL		B7	✓	✓
nIO_PULLUP		B7	✓	✓
PLL_ENA		B7	✓	✓
I/O pin	CLKUSR	B8	✓	
I/O pin	DEV_OE	B8	✓	✓
I/O pin	DEV_CLRn	B8	✓	✓
I/O pin	INIT_DONE	B3	✓	✓
DCLK		B3	✓	
I/O pin	DATA0	B3	✓	
I/O pin	DATA1	B3	✓	
I/O pin	DATA2	B3	✓	
I/O pin	DATA3	B3	✓	
I/O pin	DATA4	B3	✓	
I/O pin	DATA5	B3	✓	
I/O pin	DATA6	B3	✓	
I/O pin	DATA7	B3	✓	
I/O pin	RDYnBSY	B3	✓	
I/O pin	CRC_ERROR	B3	✓	
I/O pin	CS	B8	✓	
I/O pin	nCS	B8	✓	
I/O pin	nRS	B8	✓	
I/O pin	nWS	B8	✓	
I/O pin	RUnLU	B8	✓	
I/O pin	PGM2	B3	✓	
I/O pin	PGM1	B3	✓	
I/O pin	PGM0	B3	✓	

Stratix II Pin Name		I/O Bank	HardCopy II Use	
Main Function	Optional Function		Main Function	Optional Function
I/O pin	ASDO	B3	✓	
I/O pin	nCSO	B3	✓	

Most optional configuration pins listed in Table 8–21 support the various configuration schemes available in Stratix II FPGAs. Parallel programming and remote update configuration modes utilize most of the pins in Table 8–21. HardCopy II devices are not configurable and do not support the Configuration Emulation mode. Therefore, Altera recommends that you minimize the configuration pin requirements of the Stratix II design; for example, by using the Passive Serial configuration mode.

If some of these dual-purpose pins are needed to configure the Stratix II FPGA, but will be unused after configuration, these pins will be completely unused on the HardCopy II device. Therefore, when migrating from the Stratix II device to the HardCopy II device, care must be taken when designing these pins on board. The removal of the Stratix II device and its corresponding configuration device may leave these pins floating on the HardCopy II device if such pins are assigned as inputs by the user, without any external means of driving them to a stable level. When selecting a Stratix II device and its device options, consider the after-configuration requirements of these pins and set them appropriately in the Quartus II software (Figure 8–10).

Figure 8–10. Device and Pin Options

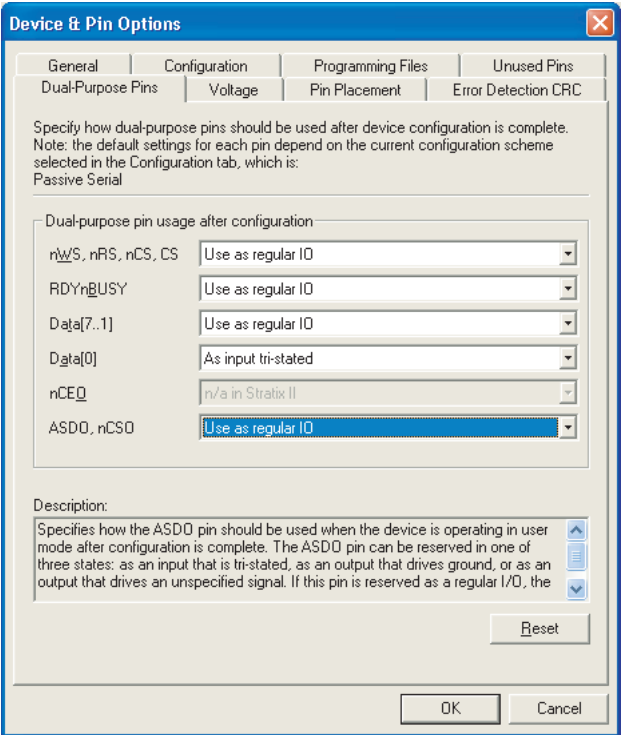

For more information about HardCopy II power-up modes, refer to the *Power-Up Modes and Configuration Emulation in HardCopy Series Devices* chapter of the *HardCopy Series Handbook*.

Conclusion

HardCopy II devices provide a seamless migration path for Stratix II devices and supports the PLL, memory, logic, and I/O features offered on a Stratix II device. The HardCopy II device architecture also allows you to use a wide range of Stratix II devices for prototyping. HardCopy II devices offer pin-to-pin compatibility with Stratix II FPGAs, making HardCopy II devices drop-in replacements on systems designed with the Quartus II software and using Stratix II and HardCopy II companion devices. Use the Quartus II software to compile designs and determine available resources to guarantee fit and feature compatibility for Stratix II and HardCopy II companion devices.

More Information

For more information on migrating Stratix II designs to HardCopy II devices, Refer to the following sources:

- *HardCopy II Device Family Data Sheet* in the *HardCopy Series Handbook*
- *Quartus II Support for HardCopy II Devices*
- *Power-Up Modes and Configuration Emulation in HardCopy Series Devices* chapter in the *HardCopy Series Handbook*

Document Revision History

Table 8–22 shows the revision history for this chapter.

Date and Document Version	Changes Made	Summary of Changes
September 2008, v1.4	Updated chapter number and metadata.	—
June 2007 v1.3	Changed “8K x 64” to “16K x 36” in Table 8–17 .	—
	Completed typographical updates.	—
December 2006 v1.2	Added revision history.	—
March 2006	Formerly chapter 19; no content change.	—
October 2005 v1.1	Minor edits	—
May 2005 v1.0	Added document to the <i>HardCopy Series Handbook</i> .	—