

10⁺Gbps 0.5mm pitch Stacking Connectors

FX10 Series Electrical Interface for the OIF 100G Long-Haul DWDM Transmission Module (MSA-100GLH)

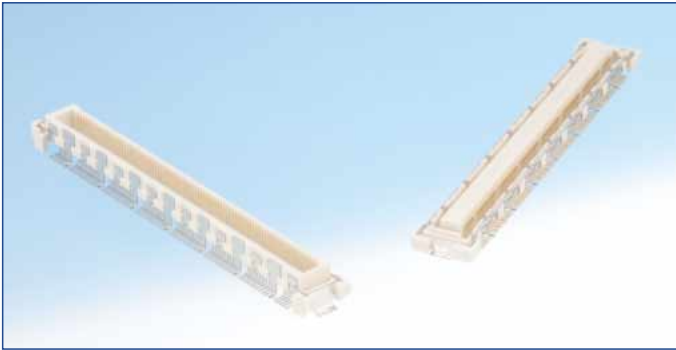

With GND Plate Type

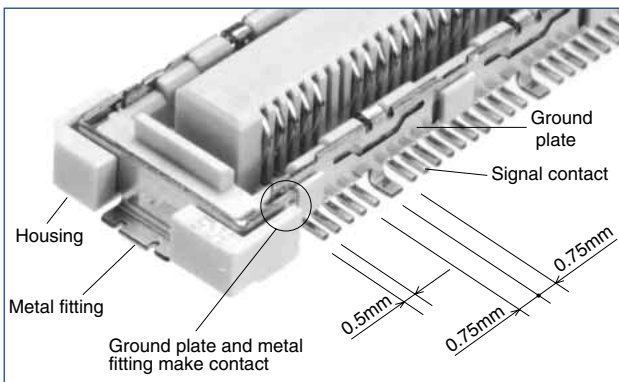

Cut Section

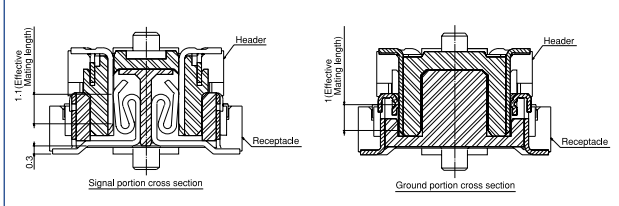

Mechanical Features

- 0.5mm Pitch
- Stacking Height : 4 ~ 8mm
- Number of Contacts
 - With ground plate type : 80 / 100 / 120 / 140
 - Without ground plate type : 96 / 120 / 144 / 168

Improved Transmission Efficiency Between Boards

Transmission characteristics have been improved through a design that fixes ground plates to both sides of the header and receptacle.

10 Signal:1 Ground Arrangement

Signal and ground are arranged in a ratio of 10:1 with the ground plate SMT connected to the board. The ground stability achieved serves to reduce noise.

Metal Fittings for Added Solder Weld Strength

Metal fittings provide greater adhesion to the board, protecting against peeling. The unique connector design provides a connection between the fitting and the ground plate for a stronger ground.

Suited to High-Density Applications

The signal contact pitch of 0.5 mm produces a smaller connector utilizing less board area for mounting.

High contact reliability

Effective mating length is 1.1 mm for signal contacts.

Optional Ground Plate

An alternate style without the ground plate is available. The space provided by the ground plate removal has been filled with additional signal contacts.

Signal Integrity Features

Insertion-Loss-to-Crosstalk-Ratio(ICR)

The insertion-loss-to-crosstalk-ratio (ICR) with five-aggressor differential FEXT meets the extrapolated IEEE 802.3ap specification for 10⁺Gbps.

Differential Impedance

The differential impedance is within 100 +/- 10 ohms at 30ps rise time (20% to 80%).

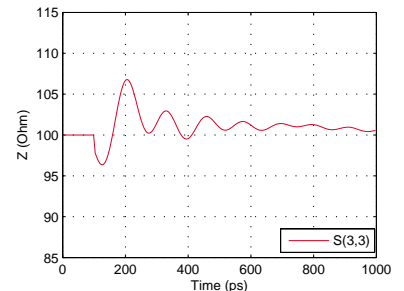
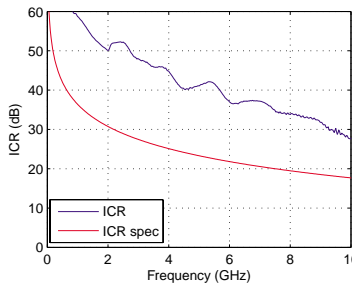

Stack Height

With ground plate

Headers	FX10#-*P/*-SV	FX10#-*P/*-SV1
Receptacles	FX10#-*S/*-SV	4mm / 5mm

Without ground plate

Headers	FX10#-*P-SV	FX10-*P-SV1	FX10#-168P-SV2	FX10#-168P-SV3	FX10#-168P-SV4
Receptacles	FX10#-*S-SV	4mm	5mm	6mm	7mm / 8mm

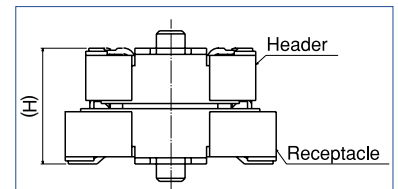

(H):Reference dimension

MSA-100GLH Electrical Interface



Product Specifications (Rating)

Rating	Rated current	Note 1 50 V AC	Operating temperature range	-55 to 85°C	Storage temperature range	-40 to +60°C (Note 2)
	Rated voltage		Operating humidity range	Relative humidity 95% max (No condensation)	Storage humidity range	40 to 70% (Note 2)

Note 1: Refer to FX10-168pin derating curves from test reports TR570E-20587.

Note 2: The term storage refers to an unused products prior to board mounting (including packing materials) that is being kept for a long period. The operating temperature and humidity range are suited to the non-conducting condition following board assembly.

Note 3: Other information are shown in General Product Specifications.

Receptacles without ground plate

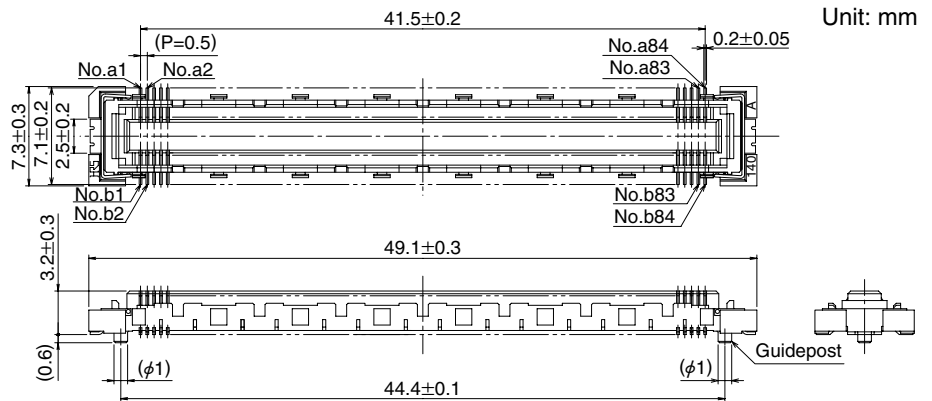

Part No.	CL No.	Number of Contacts	Remarks
		Signal	
FX10A-168S-SV (**)	570-0244-7-**	168	With guideposts
FX10B-168S-SV (**)	570-0254-0-**		Without guideposts

[Specifications number] -** , (**)
 (83): Embossed tape packaging / AuP 0.76μm (93): Tray packaging / AuP 0.76μm

Note 1: There is no polarity in terms of board mounting for this product.

Note 2: The coplanarity of this product's SMT leads is 0.1 mm or less.

Note 3: Please order embossed tape packaged items by the reel. (One reel holds 1,000 pieces.)

Note 4: Using multiple connectors between identical boards is not recommended.

Recommended Land Pattern Dimensions(Metal Mask Dimensions)

Recommended metal mask thickness: 0.15mm

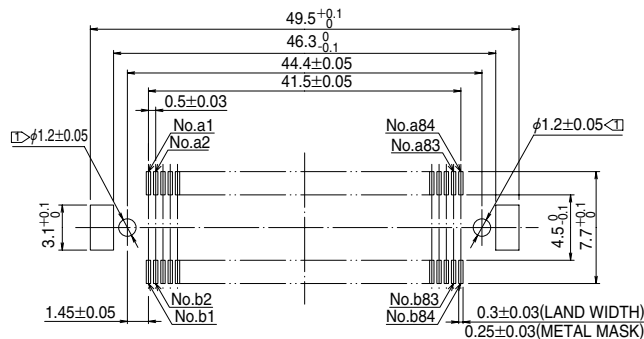

Note 1: Not required in products without guideposts.

Board-to-Board Distance

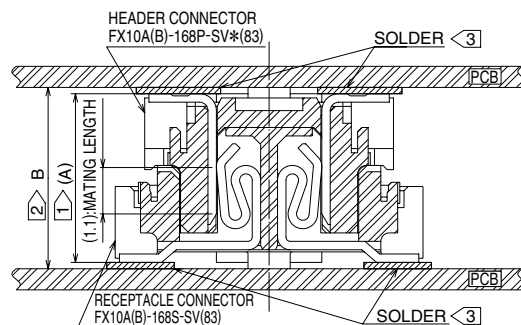

	FX10A(B)-168S-SV(83)	
	1 > (A)	2 > B
FX10A(B)-168P-SV(83)	4	4.3±0.127
FX10A(B)-168P-SV1(83)	5	5.3±0.127
FX10A(B)-168P-SV2(83)	6	6.0±0.127
FX10A(B)-168P-SV3(83)	7	7.0±0.127
FX10A(B)-168P-SV4(83)	8	8.0±0.127

Note 1: Stacking height from lead to lead (reference dimensions)
 2: Board-to-board distance
 3: Stencil (metal mask) shall be based on Hirose's recommended aperture and thickness.

MSA-100GLH Electrical Interface



■Headers without ground plate

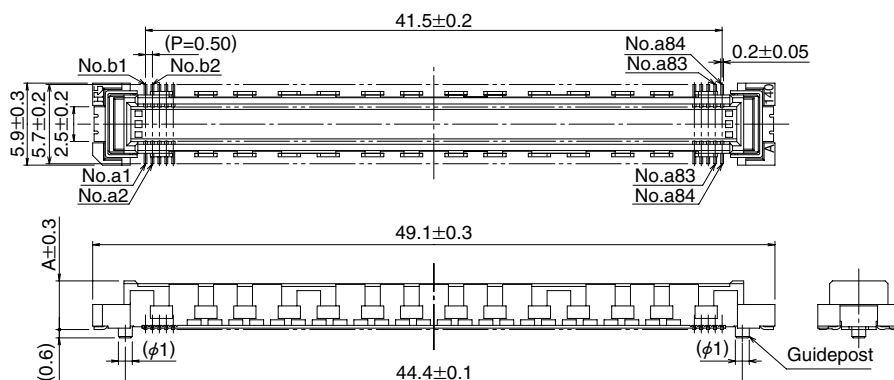

Unit: mm

Part No.	CL No.	Number of Contacts	A	Quantity/Reel (Note 3)	Remarks
		Signal			
FX10A-168P-SV (**)	570-0044-8-**	168	3.5	1,000	With guideposts
FX10A-168P-SV1 (**)	570-0144-2-**		4.5	1,000	
FX10A-168P-SV2 (**)	570-0302-1-**		5.25	900	
FX10A-168P-SV3 (**)	570-0304-7-**		6.25	800	
FX10A-168P-SV4 (**)	570-0306-2-**		7.25	700	Without guideposts
FX10B-168P-SV (**)	570-0054-1-**		3.5	1,000	
FX10B-168P-SV1 (**)	570-0154-6-**		4.5	1,000	
FX10B-168P-SV2 (**)	570-0303-4-**		5.25	900	
FX10B-168P-SV3 (**)	570-0305-0-**		6.25	800	
FX10B-168P-SV4 (**)	570-0307-5-**		7.25	700	

[Specifications number] -*, (**)
 (83): Embossed tape packaging / AuP 0.76μm (93): Tray packaging / AuP 0.76μm

Note 1: There is no polarity in terms of board mounting for this product.

Note 2: The coplanarity of this product's SMT leads is 0.1 mm or less.

Note 3: Please order embossed tape packaged items by the reel.

Note 4: Using multiple connectors between identical boards is not recommended.

■Recommended Land Pattern Dimensions (Metal Mask Dimensions)

Recommended metal mask thickness: 0.15 mm

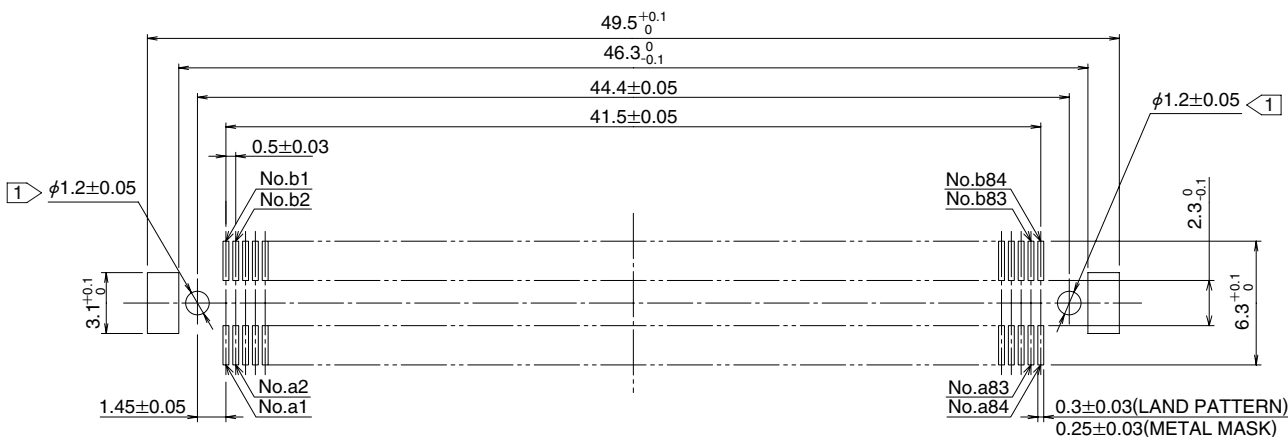

Note 1) Not required in products without guideposts.

Signal integrity

Pin assignment

To match 100 ohm differential impedance and to reduce crosstalk, a staggered GSGSG pin assignment is recommended. (G=ground and S=signal)

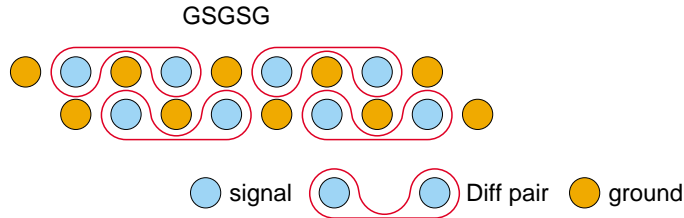

Impedance

The differential impedance is 100 +/- 10 ohm for FX10 at 30 ps rise time (20% to 80%).

4 mm (without GND)

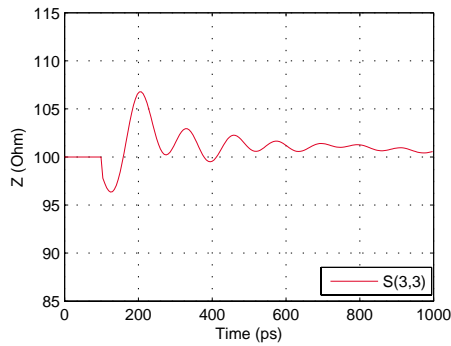

5 mm (without GND)

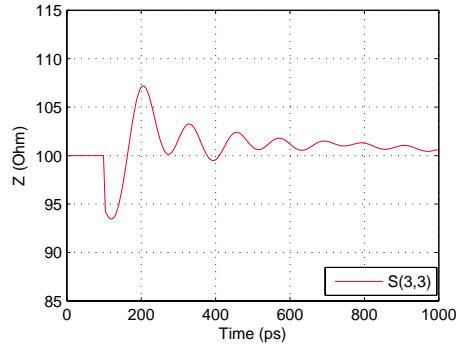

4 mm (with GND)

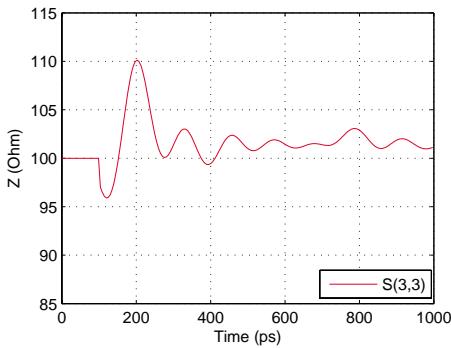

5 mm (with GND)

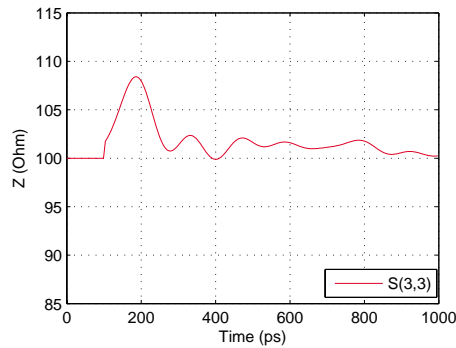

Propagation delay

The propagation delay is 62 and 67 ps for FX10 of 4mm and 5mm height (with and without GND), respectively.

● Insertion loss

The differential insertion loss crosses 1 dB at 10.8 and 9.2 GHz for FX10 of 4mm and 5mm height, respectively.

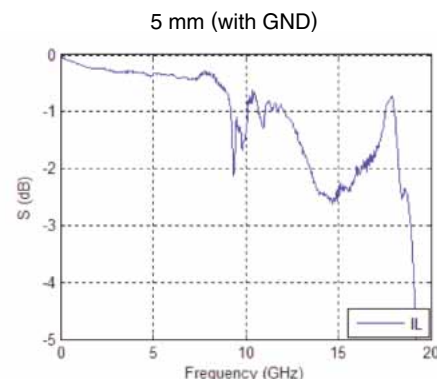
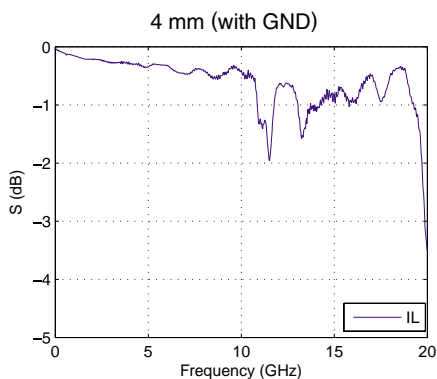
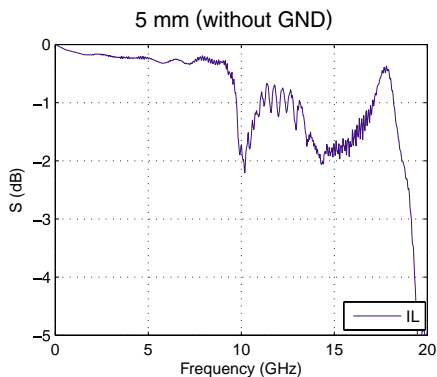
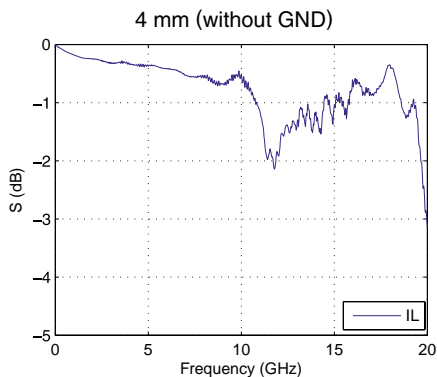

● Return loss

The differential return loss meets the IEEE 802.3ap specification to 20+ and 13.5 GHz for FX10 of 4mm and 5mm height, respectively.

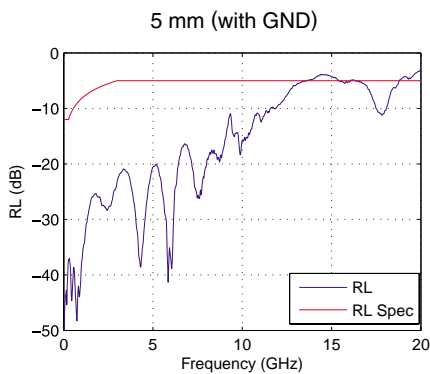
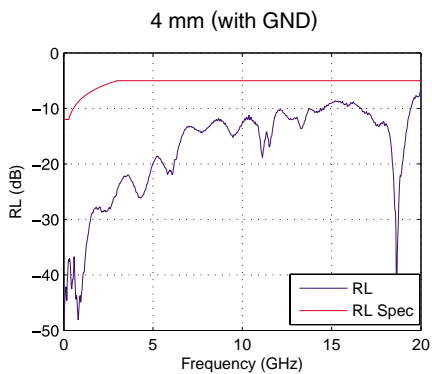
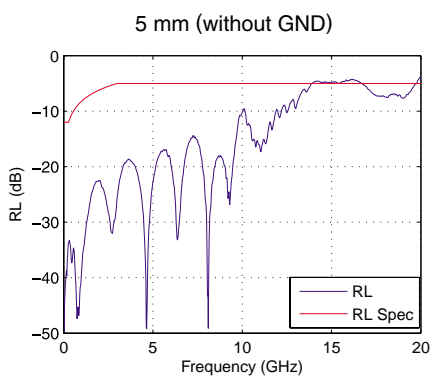
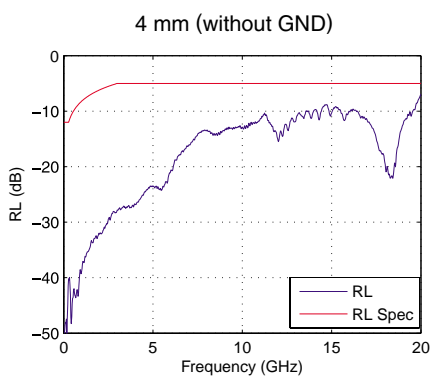

● **Near-end crosstalk (NEXT)**

The staggered GSGSG pin assignment results in low differential NEXT between neighboring pairs.

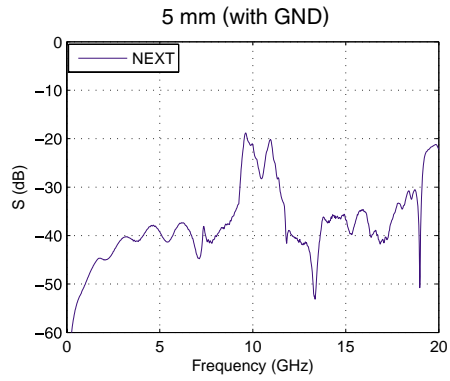
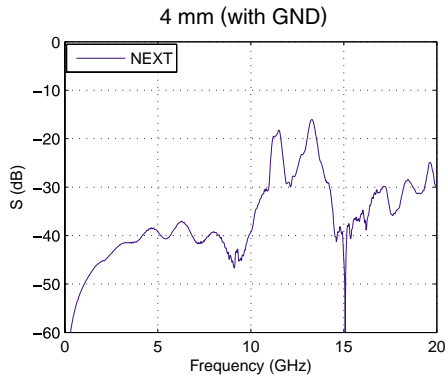
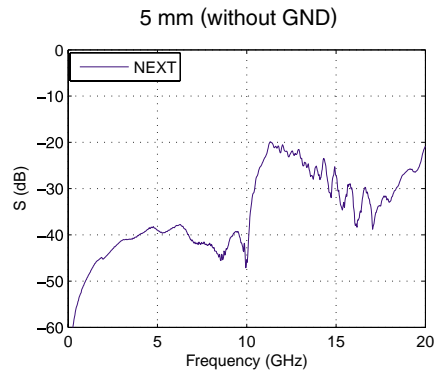
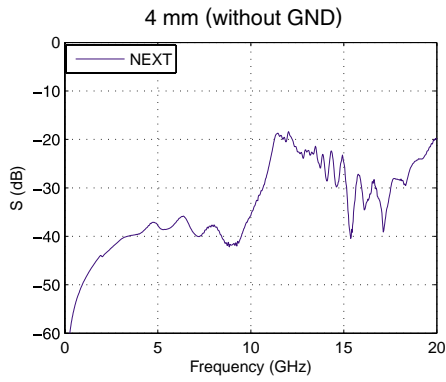

● **Far-end crosstalk (FEXT)**

The staggered GSGSG pin assignment results in low differential FEXT between neighboring pairs.

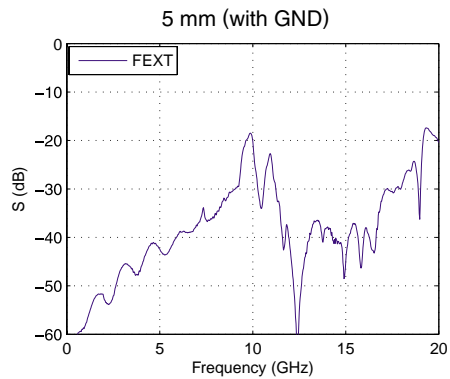
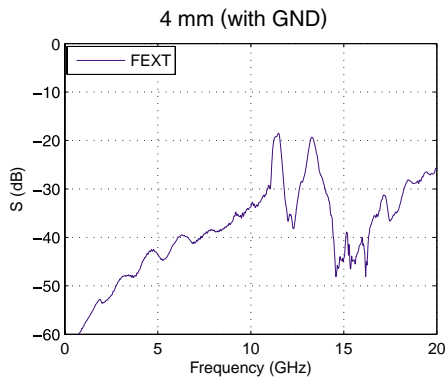
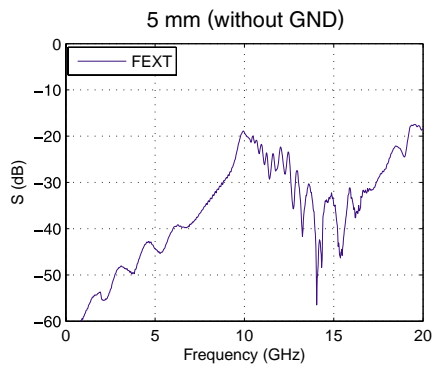
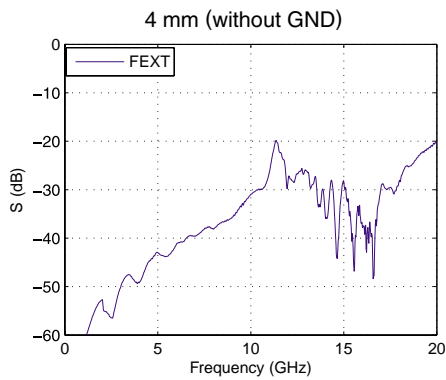

● **Insertion-loss-to-crosstalk ratio (ICR)**

The insertion-loss-to-crosstalk ratio (ICR) with five-aggressor differential FEXT meets the extrapolated IEEE 802.3ap specification to 10+ Gbps.

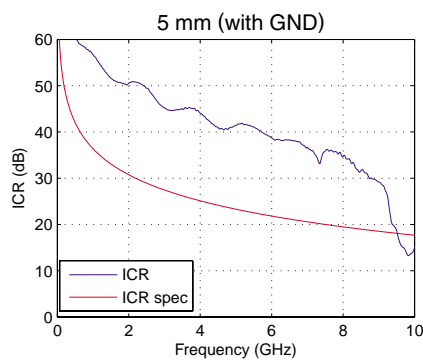
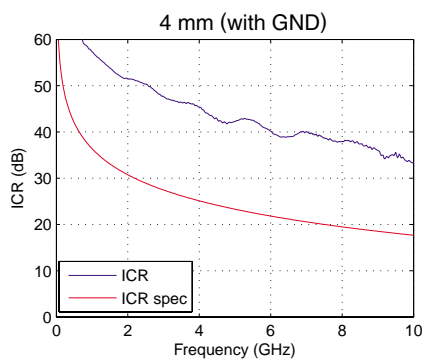
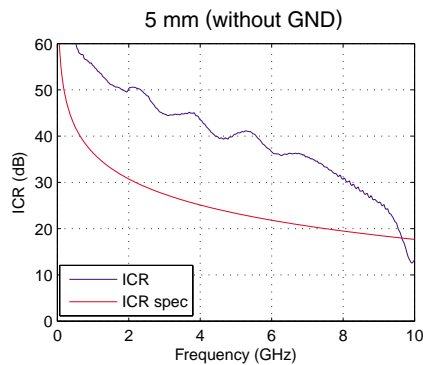
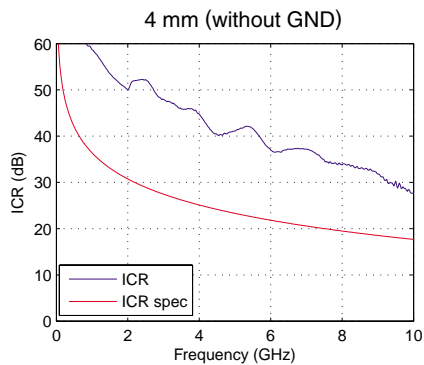

■General Product Specifications

Rating	Rated current	0.3 A	Operating temperature range	-55 to 85°C (Note 1)	Storage temperature range	-10 to +60°C (Note 2)
	Rated voltage	50 V AC	Operating humidity range	Relative humidity 95% max (No condensation)	Storage humidity range	40 to 70% (Note 2)

Item	Requirements	Conditions
1. Insulation resistance	100 M ohm min	Measured at 100 V DC
2. Voltage resistance	No flashover or breakdown	150 V AC applied for one minute
3. Contact resistance	60 m ohm max	Measured at 100 mA
4. Vibration	No electrical discontinuity for 1μs min No damage, cracks, or parts looseness	Frequency: 10 to 55 Hz, amplitude of 0.75 mm in 3 directions, 10 cycles each
5. Shock	No electrical discontinuity for 1μs min No damage, cracks, or parts looseness	Acceleration of 490 m/s ² , 11 ms duration, sine half-wave waveform, for 3 cycles in the both directions of each of the 3 axes
6. Damp heat (Steady state)	Contact resistance of 70 m ohm max, insulation resistance of 100 M ohm min, no damage, cracks, or parts looseness	Temperature of 40°C, humidity of 90 to 95%, duration 96 h
7. Temperature cycle	Contact resistance of 70 m ohm max, insulation resistance of 100 M ohm min, no damage, cracks, or parts looseness	Temperature: -55°C → 15 to 35°C → 85°C → 15 to 35°C Time: 30 min. → 2 to 3 min. → 30 min. → 2 to 3 min. for 5 cycles
8. Durability	Contact resistance of 70 m ohm max No damage, cracks, or parts looseness	50 times
9. Resistance to soldering heat	No melting of resin portion which affects performance	Reflow: At the recommended temperature profile Soldering iron temperature: 360°C for 5 seconds

Note 1: Includes temperature rise caused by current flow.

Note 2: The term storage refers to an unused products prior to board mounting (including packing materials) that is being kept for a long period. The operating temperature and humidity range are suited to the non-conducting condition following board assembly.

Note 3: Information contained in this catalog represents general requirements for this series. Contact us for the drawings and specifications for a specific part number shown.

■Materials

Part	Material	Process	Notes
Insulator	LCP	Beige	UL94V-0
Contacts	Phosphor bronze	Header Contact Area: Gold plating Lead Area: Tin plating	_____
		Receptacle Contact Area: Gold plating Lead Area: Flash plating	
Ground plate	Phosphor bronze	Tin plating	_____
Metal fitting	Phosphor bronze	Tin plating	_____

■Ordering Information

FX10 **#** - ***** **P** / ***** - **SV** **1** (******)
① ② ④ ⑤ ⑥ ⑦
③

① Series name : FX10	④ Connector type P : Header S : Receptacle
② Form symbol A : With guide post B : Without guide post	⑤ Contact form SV : Straight SMT
③ Number of contacts <input type="text" value="With ground plate"/> Signal/Ground: 80/8, 100/10, 120/12, 140/14 <input type="text" value="Without ground plate"/> Signal: 96, 120, 144, 168	⑥ Product height Blank : Standard 1 : Standard + 1mm
	⑦ Packaging classification Blank, (71) : Tray packaging (21), (91): Embossed tape packaging

■Headers with ground plate

●4mm Stacking Height

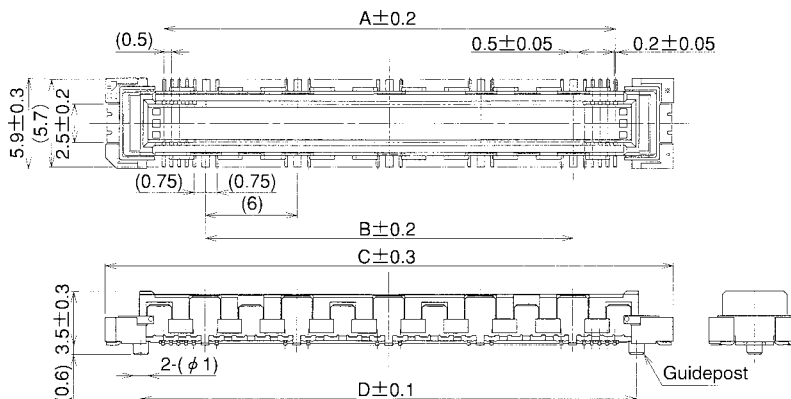

Unit: mm

Part No.	CL No.	Number of Contacts		A	B	C	D	E	F	Remarks
		Signal	Ground							
FX10A- 80P/ 8-SV(**)	CL570-0001-5-**	80	8	23.5	18	31.1	26.4	31.5	28.3	With guideposts
FX10A-100P/10-SV(**)	CL570-0002-8-**	100	10	29.5	24	37.1	32.4	37.5	34.3	
FX10A-120P/12-SV(**)	CL570-0003-0-**	120	12	35.5	30	43.1	38.4	43.5	40.3	
FX10A-140P/14-SV(**)	CL570-0004-3-**	140	14	41.5	36	49.1	44.4	49.5	46.3	
FX10B- 80P/ 8-SV(**)	CL570-0021-2-**	80	8	23.5	18	31.1	—	31.5	28.3	Without guideposts
FX10B-100P/10-SV(**)	CL570-0022-5-**	100	10	29.5	24	37.1	—	37.5	34.3	
FX10B-120P/12-SV(**)	CL570-0023-8-**	120	12	35.5	30	43.1	—	43.5	40.3	
FX10B-140P/14-SV(**)	CL570-0024-0-**	140	14	41.5	36	49.1	—	49.5	46.3	

[Specifications number] -* *, (**)
 (71): Tray packaging
 (91): Embossed tape packaging

Note 1: There is no polarity in terms of board mounting for this product.

Note 2: The coplanarity of this product's SMT leads is 0.1mm or less.

Note 3: Please order embossed tape packaged items by the reel. (One reel holds 1,000 pieces.)

Note 4: Using multiple connectors between identical boards is not recommended.

■Recommended Land Pattern Dimensions (Metal Mask Dimensions)

Recommended metal mask thickness: 0.15 mm

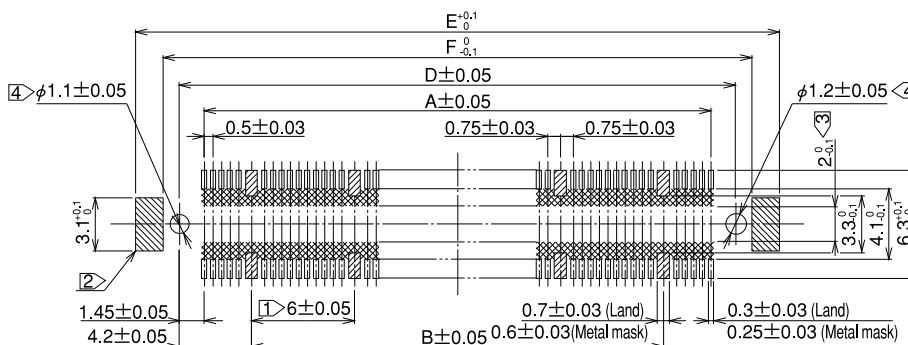

Note ① Cross-hatched portions, totaling n places, indicate the ground circuits.

Note ② Cross-hatched portions, 2 places on both sides, indicate the metal fittings.

Note ③ The cross-hatched area inside the SMT land may come into contact with the connector contacts and thus care should be taken that the pattern does not extend beyond the SMT land width.

Note ④ Not required in products without guideposts.

■ Headers with ground plate

● 5mm Stacking Height

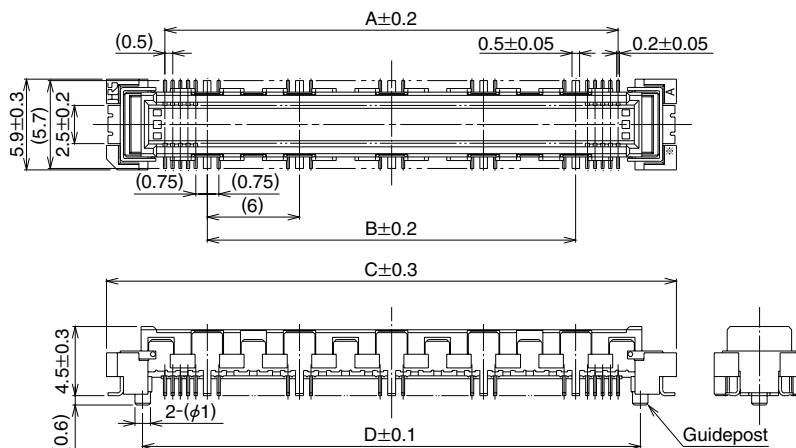

Unit: mm

Part No.	CL No.	Number of Contacts		A	B	C	D	E	F	Remarks
		Signal	Ground							
FX10A- 80P/ 8-SV1(**)	CL570-0101-0-**-	80	8	23.5	18	31.1	26.4	31.5	28.3	With guideposts
FX10A-100P/10-SV1(**)	CL570-0102-2-**-	100	10	29.5	24	37.1	32.4	37.5	34.3	
FX10A-120P/12-SV1(**)	CL570-0103-5-**-	120	12	35.5	30	43.1	38.4	43.5	40.3	
FX10A-140P/14-SV1(**)	CL570-0104-8-**-	140	14	41.5	36	49.1	44.4	49.5	46.3	
FX10B- 80P/ 8-SV1(**)	CL570-0121-7-**-	80	8	23.5	18	31.1	—	31.5	28.3	Without guideposts
FX10B-100P/10-SV1(**)	CL570-0122-0-**-	100	10	29.5	24	37.1	—	37.5	34.3	
FX10B-120P/12-SV1(**)	CL570-0123-2-**-	120	12	35.5	30	43.1	—	43.5	40.3	
FX10B-140P/14-SV1(**)	CL570-0124-5-**-	140	14	41.5	36	49.1	—	49.5	46.3	

[Specifications number] -*, (**)
 (71): Tray packaging
 (91): Embossed tape packaging

Note 1: There is no polarity in terms of board mounting for this product.

Note 2: The coplanarity of this product's SMT leads is 0.1 mm or less.

Note 3: Please order embossed tape packaged items by the reel. (One reel holds 1,000 pieces.)

Note 4: Using multiple connectors between identical boards is not recommended.

■ Recommended Land Pattern Dimensions (Metal Mask Dimensions)

Recommended metal mask thickness: 0.15 mm

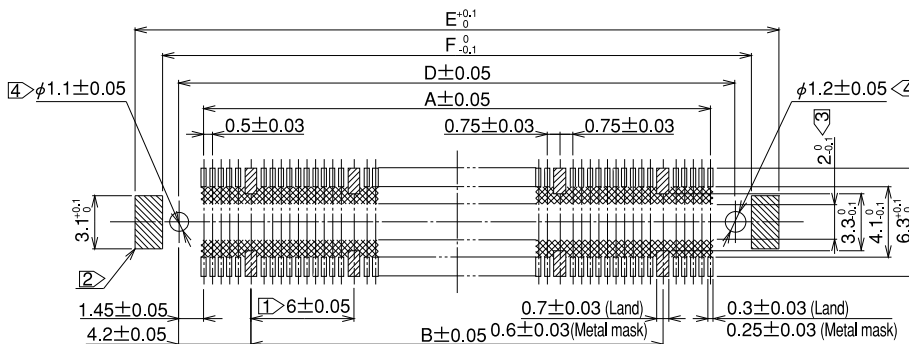

Note ① Cross-hatched portions, totaling n places, indicate the ground circuits.

② Cross-hatched portions, 2 places on both sides, indicate the metal fittings.

③ The cross-hatched area inside the SMT land may come into contact with the connector contacts and thus care should be taken that the pattern does not extend beyond the SMT land width.

④ Not required in products without guideposts.

Receptacles with ground plate

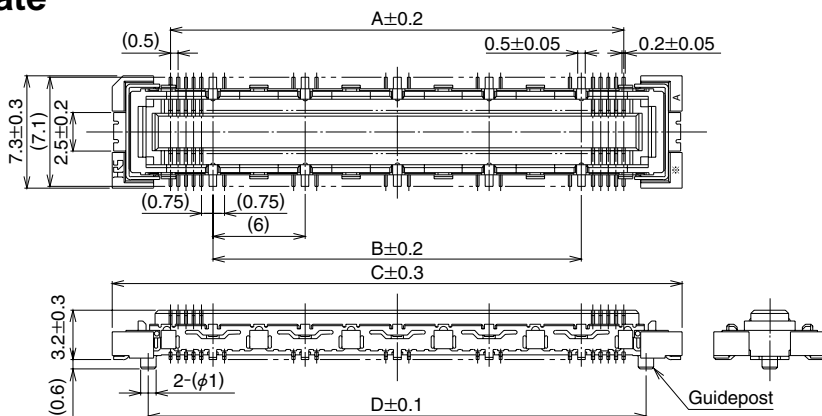

Unit: mm

Part No.	CL No.	Number of Contacts		A	B	C	D	E	F	Remarks
		Signal	Ground							
FX10A- 80S/ 8-SV(**)	CL570-0201-4-**(71)	80	8	23.5	18	31.1	26.4	31.5	28.3	With guideposts
FX10A-100S/10-SV(**)	CL570-0202-7-**(71)	100	10	29.5	24	37.1	32.4	37.5	34.3	
FX10A-120S/12-SV(**)	CL570-0203-0-**(91)	120	12	35.5	30	43.1	38.4	43.5	40.3	
FX10A-140S/14-SV(**)	CL570-0204-2-**(91)	140	14	41.5	36	49.1	44.4	49.5	46.3	
FX10B- 80S/ 8-SV(**)	CL570-0221-1-**(71)	80	8	23.5	18	31.1	—	31.5	28.3	Without guideposts
FX10B-100S/10-SV(**)	CL570-0222-4-**(71)	100	10	29.5	24	37.1	—	37.5	34.3	
FX10B-120S/12-SV(**)	CL570-0223-7-**(91)	120	12	35.5	30	43.1	—	43.5	40.3	
FX10B-140S/14-SV(**)	CL570-0224-0-**(91)	140	14	41.5	36	49.1	—	49.5	46.3	

[Specifications number] - ** , (** *)
 (71): Tray packaging
 (91): Embossed tape packaging

Note 1: There is no polarity in terms of board mounting for this product.

Note 2: The coplanarity of this product's SMT leads is 0.1 mm or less.

Note 3: Please order embossed tape packaged items by the reel. (One reel holds 1,000 pieces.)

Recommended Land Pattern Dimensions (Metal Mask Dimensions)

Recommended metal mask thickness: 0.15 mm

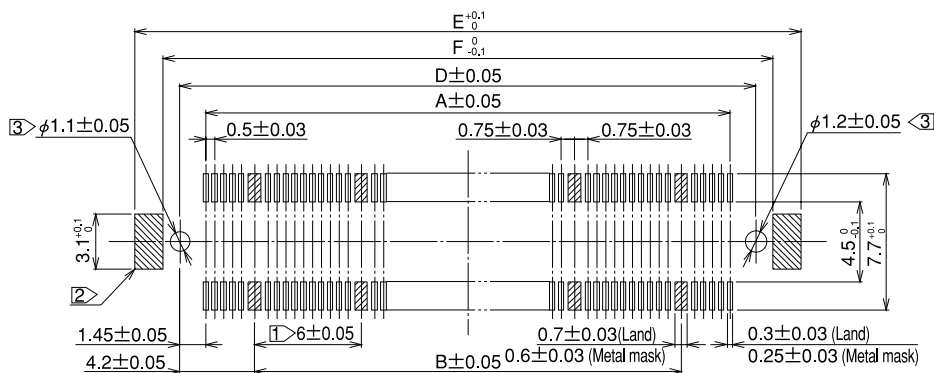

Note ① Cross-hatched portions, totaling n places, indicate the ground circuits.

Note ② Cross-hatched portions, 2 places on both sides, indicate the metal fittings.

Note ③ Not required in products without guideposts.

■ Headers without ground plate

● 4mm Stacking Height

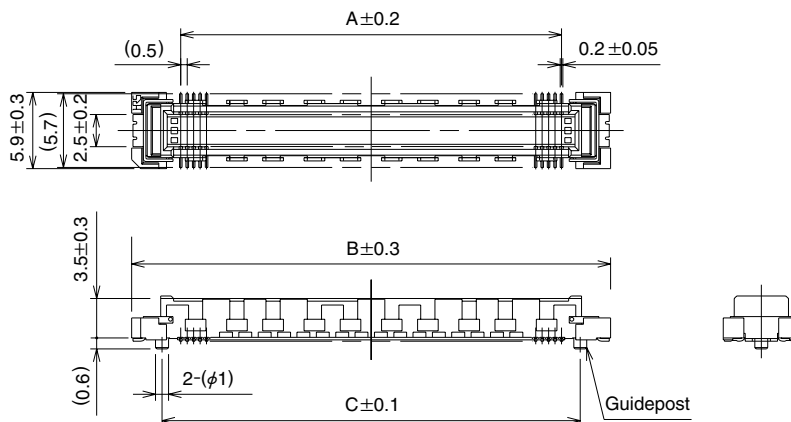

Unit: mm

Part No.	CL No.	Number of Contacts	A	B	C	D	E	Remarks
		Signal						
FX10A- 96P-SV(**)	CL570-0041-0-**	96	23.5	31.1	26.4	31.5	28.3	With guideposts
FX10A-120P-SV(**)	CL570-0042-2-**	120	29.5	37.1	32.4	37.5	34.3	
FX10A-144P-SV(**)	CL570-0043-5-**	144	35.5	43.1	38.4	43.5	40.3	
FX10A-168P-SV(**)	CL570-0044-8-**	168	41.5	49.1	44.4	49.5	46.3	
FX10B- 96P-SV(**)	CL570-0051-3-**	96	23.5	31.1	—	31.5	28.3	Without guideposts
FX10B-120P-SV(**)	CL570-0052-6-**	120	29.5	37.1	—	37.5	34.3	
FX10B-144P-SV(**)	CL570-0053-9-**	144	35.5	43.1	—	43.5	40.3	
FX10B-168P-SV(**)	CL570-0054-1-**	168	41.5	49.1	—	49.5	46.3	

[Specifications number] -* *, (**)
 (71): Tray packaging
 (91): Embossed tape packaging

Note 1: There is no polarity in terms of board mounting for this product.

Note 2: The coplanarity of this product's SMT leads is 0.1 mm or less.

Note 3: Please order embossed tape packaged items by the reel. (One reel holds 1,000 pieces.)

■ Recommended Land Pattern Dimensions (Metal Mask Dimensions)

Recommended metal mask thickness: 0.15 mm

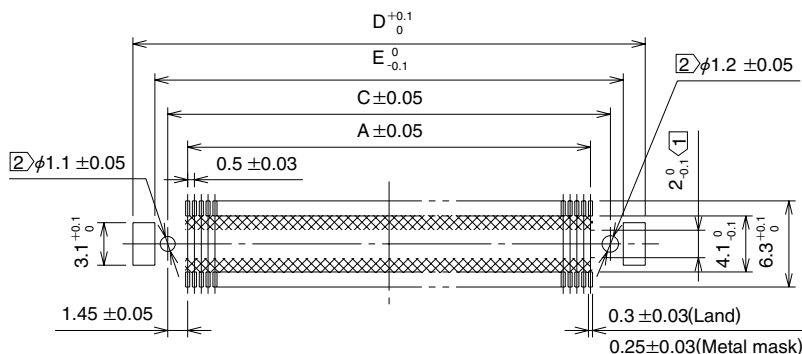

Note ① The cross-hatched area  inside the SMT land may come into contact with the connector contacts and thus care should be taken that the pattern does not extend beyond the SMT land width.

Note ② Not required in products without guideposts.

■Headers without ground plate

●5mm Stacking Height

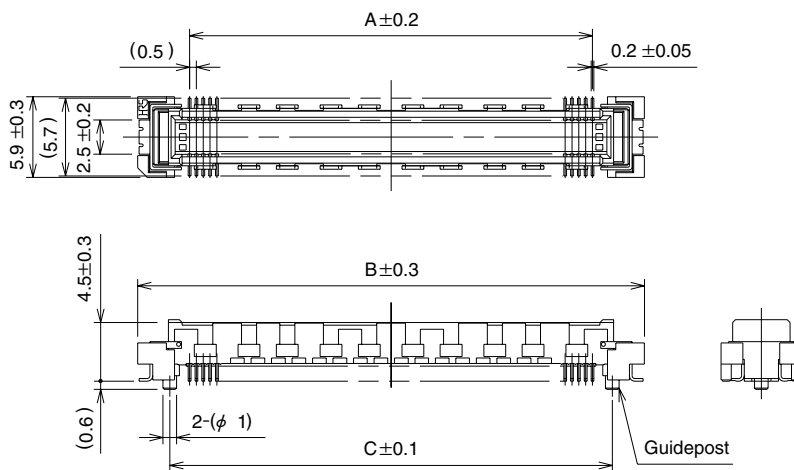

Unit: mm

Part No.	CL No.	Number of Contacts	A	B	C	D	E	Remarks
		Signal						
FX10A- 96P-SV1(**)	CL570-0141-4-***	96	23.5	31.1	26.4	31.5	28.3	With guideposts
FX10A-120P-SV1(**)	CL570-0142-7-***	120	29.5	37.1	32.4	37.5	34.3	
FX10A-144P-SV1(**)	CL570-0143-0-***	144	35.5	43.1	38.4	43.5	40.3	
FX10A-168P-SV1(**)	CL570-0144-2-***	168	41.5	49.1	44.4	49.5	46.3	
FX10B- 96P-SV1(**)	CL570-0151-8-***	96	23.5	31.1	—	31.5	28.3	Without guideposts
FX10B-120P-SV1(**)	CL570-0152-0-***	120	29.5	37.1	—	37.5	34.3	
FX10B-144P-SV1(**)	CL570-0153-3-***	144	35.5	43.1	—	43.5	40.3	
FX10B-168P-SV1(**)	CL570-0154-6-***	168	41.5	49.1	—	49.5	46.3	

[Specifications number] -** , (**)
 (71): Tray packaging
 (91): Embossed tape packaging

Note 1: There is no polarity in terms of board mounting for this product.

Note 2: The coplanarity of this product's SMT leads is 0.1 mm or less.

Note 3: Please order embossed tape packaged items by the reel. (One reel holds 1,000 pieces.)

Note 4: Using multiple connectors between identical boards is not recommended.

■Recommended Land Pattern Dimensions (Metal Mask Dimensions)

Recommended metal mask thickness: 0.15 mm

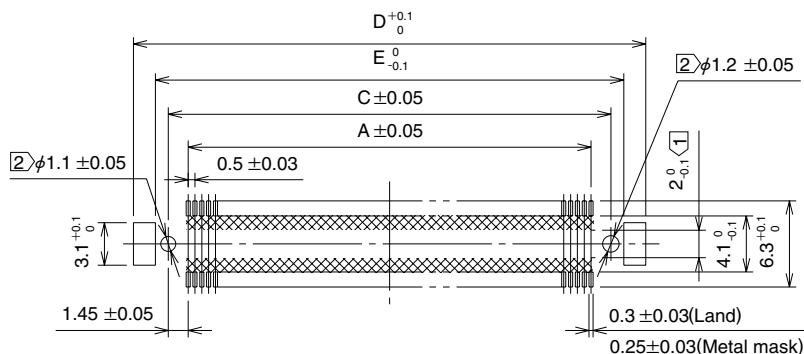

Note ① The cross-hatched area inside the SMT land may come into contact with the connector contacts and thus care should be taken that the pattern does not extend beyond the SMT land width.

Note ② Not required in products without guideposts.

Receptacles without ground plate

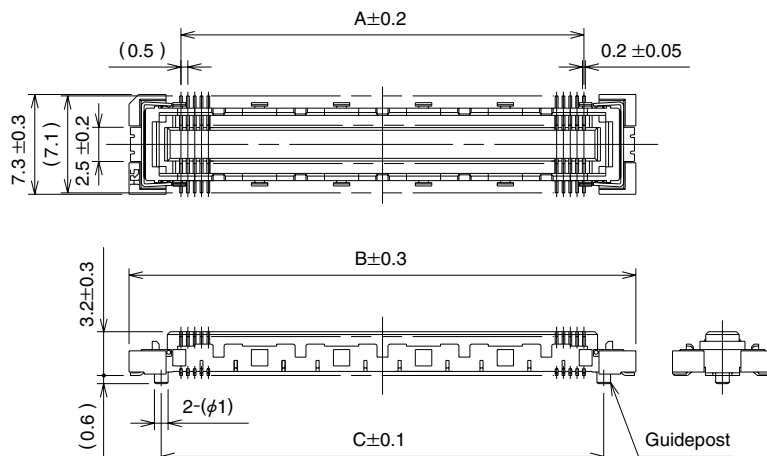

Unit: mm

Part No.	CL No.	Number of Contacts	A	B	C	D	E	Remarks
		Signal						
FX10A- 96S-SV(**)	CL570-0241-9-**-	96	23.5	31.1	26.4	31.5	28.3	With guideposts
FX10A-120S-SV(**)	CL570-0242-1-**-	120	29.5	37.1	32.4	37.5	34.3	
FX10A-144S-SV(**)	CL570-0243-4-**-	144	35.5	43.1	38.4	43.5	40.3	
FX10A-168S-SV(**)	CL570-0244-7-**-	168	41.5	49.1	44.4	49.5	46.3	
FX10B- 96S-SV(**)	CL570-0251-2-**-	96	23.5	31.1	—	31.5	28.3	Without guideposts
FX10B-120S-SV(**)	CL570-0252-5-**-	120	29.5	37.1	—	37.5	34.3	
FX10B-144S-SV(**)	CL570-0253-8-**-	144	35.5	43.1	—	43.5	40.3	
FX10B-168S-SV(**)	CL570-0254-0-**-	168	41.5	49.1	—	49.5	46.3	

[Specifications number] -*, (**)
 (71): Tray packaging
 (91): Embossed tape packaging

Note 1: There is no polarity in terms of board mounting for this product.

Note 2: The coplanarity of this product's SMT leads is 0.1 mm or less.

Note 3: Please order embossed tape packaged items by the reel. (One reel holds 1,000 pieces.)

Note 4: Using multiple connectors between identical boards is not recommended.

Recommended Land Pattern Dimensions (Metal Mask Dimensions)

Recommended metal mask thickness: 0.15 mm

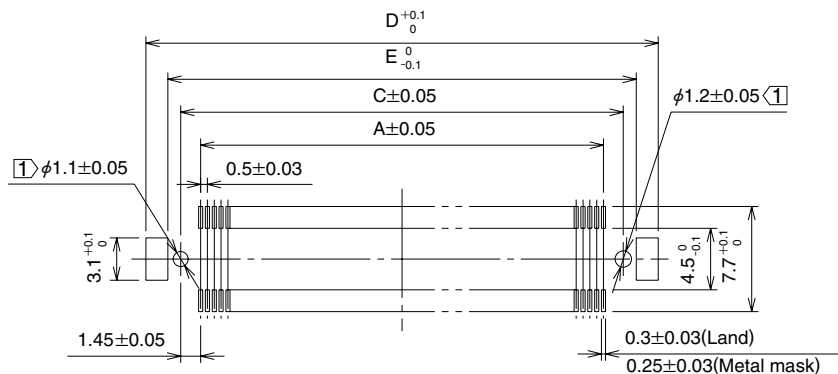

Note ① Not required in products without guideposts.

■ Embossed Carrier Tape Dimensions

● Headers

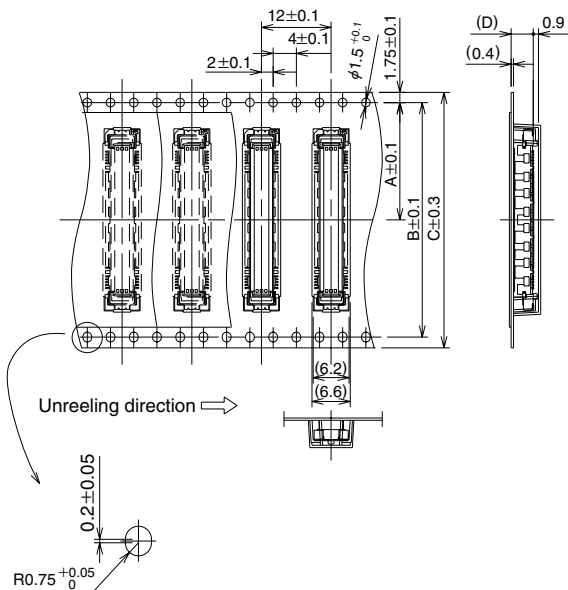

● Receptacles

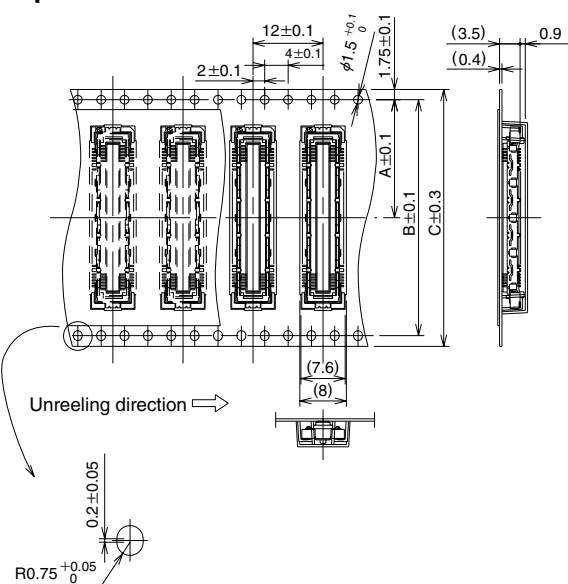

● Reel Dimensions

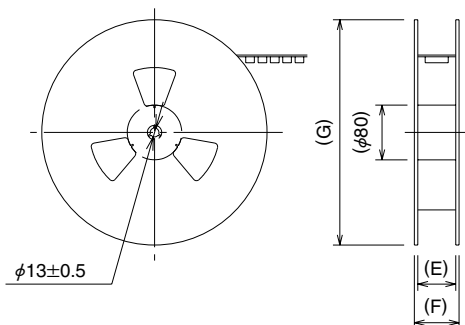

Unit: mm

Insertion Connector	A	B	C	D	E	F	G
FX10#- 80P/ 8-SV	20.2	40.4	44	3.8	45.5	50.5	330
FX10#-100P/10-SV	26.2	52.4	56		59	64	
FX10#-120P/12-SV					76.5	81.5	
FX10#-140P/14-SV	34.2	68.4	72		45.5	50.5	
FX10#- 96P -SV	20.2	40.4	44		59	64	
FX10#-120P -SV	26.2	52.4	56		76.5	81.5	
FX10#-144P -SV	34.2	68.4	72		45.5	50.5	
FX10#-168P -SV	26.2	52.4	56		59	64	
FX10#- 80P/ 8-SV1	20.2	40.4	44	4.8	45.5	50.5	370
FX10#-100P/10-SV1	26.2	52.4	56		59	64	
FX10#-120P/12-SV1					76.5	81.5	
FX10#-140P/14-SV1	34.2	68.4	72		45.5	50.5	
FX10#- 96P -SV1	20.2	40.4	44		59	64	
FX10#-120P -SV1	26.2	52.4	56		76.5	81.5	
FX10#-144P -SV1	34.2	68.4	72		45.5	50.5	
FX10#-168P -SV1	26.2	52.4	56		59	64	

Note: There is no polarity in terms of embossed tape packaging for this product.

Unit: mm

Insertion Connector	A	B	C	E	F	G
FX10#- 80S/ 8-SV	20.2	40.4	44	45.5	50.5	330
FX10#-100S/10-SV	26.2	52.4	56	59	64	
FX10#-120S/12-SV				76.5	81.5	
FX10#-140S/14-SV	34.2	68.4	72	45.5	50.5	
FX10#- 96S -SV	20.2	40.4	44	59	64	
FX10#-120S -SV	26.2	52.4	56	76.5	81.5	
FX10#-144S -SV	34.2	68.4	72	45.5	50.5	
FX10#-168S -SV	26.2	52.4	56	59	64	

Note: There is no polarity in terms of embossed tape packaging for this product.

Recommended Temperature Profile

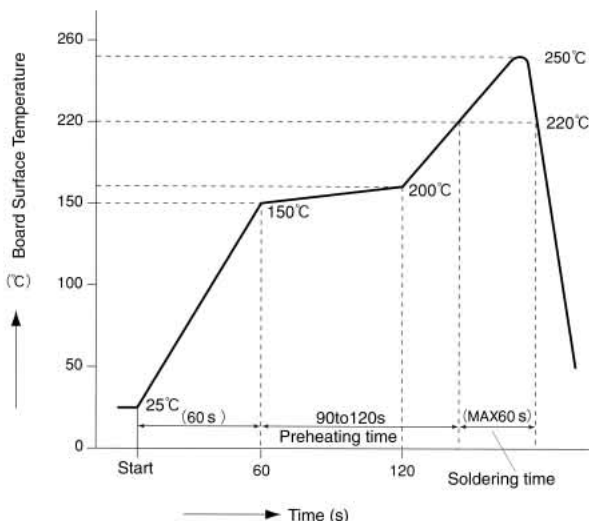

HRS test Conditions

Test board Glass epoxy 161mm×100mm×1.6mm thick

Solder method :Reflow

Solder composition :Paste,
96.5%Sn/3%Ag/0.5%Cu

Metal mask :0.15mm thick

Reflow cycles :2 cycles

The temperature profile is based on the above conditions. In individual applications the actual temperature may vary, depending on solder paste type, volume/thickness and board size/thickness. Consult your solder paste and equipment manufacturer for specific recommendations.

Washing Conditions

Organic Solvent Cleaning

Solvent	Room temperature washing	Heated washing
IPA (Isopropyl alcohol)	Yes	Yes
HCFC (Hydrochlorofluorocarbon)	Yes	Yes

Water Type Cleaning

When using water based cleaning agents (e.g., terpene, and alkali saponifiers), select the cleaning agent based on the documentation issued by the various manufacturers of cleaning agents which describes the effects on metals and resins. Be careful that parts are not left with moisture remaining on them.

Cleaning Precautions

Residual flux or cleaning agent on the contacts when washing with organic solvents or water type cleaners can give rise to the deterioration of electrical performance. In this regard it is important to check whether a thorough washing has been performed.

Connector Handling Precautions

1. Allowable Creepage Dimensions at Time of Mating

The effective mating length of this product is 1.1 mm for the signal portion and 1 mm for the ground portion. The creepage of the header and receptacle at the time of mating should be within 0.5 mm of the completely mating condition.

2. Retension of Boards

Avoid the support of boards by connectors alone and adopt a locking measure that does not rely on the connectors.

3. Solder Repair

Flux may rise as far as the contact portion of the connector depending on the flux coating and other factors at the time of repair. This will cause poor contact reliability; therefore, before use, the aforementioned washing conditions should be taken into consideration prior to connector washing.

4. Miscellaneous

·Note that excessive twisting while inserting or withdrawing connectors will cause damage.

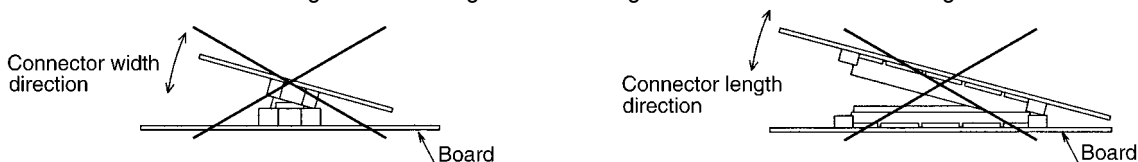

·The shade of the molded items may vary somewhat depending on the manufacturing lot; however, this does not affect performance.

NOTES :

A series of horizontal dashed lines for taking notes.

USA:

HIROSE ELECTRIC (U.S.A.), INC. Headquarters

2688 Westhills Court, Simi Valley, CA 93065-6235
Phone : 1-805-522-7958
Fax : 1-805-522-3217
<http://www.hiroseusa.com>

USA:

HIROSE ELECTRIC (U.S.A.), INC. North California Office

20400 Stevens Creek Blvd., Ste 250, Cupertino, CA 95014
Phone : 1-408-253-9640
Fax : 1-408-253-9641
<http://www.hiroseusa.com>

USA:

HIROSE ELECTRIC (U.S.A.), INC. Detroit Office (Automotive)

37677 Professional Center Drive, Suite #100C Livonia, MI 48154
Phone : 1-734-542-9963
Fax : 1-734-542-9964
<http://www.hiroseusa.com>

GERMANY:

HIROSE ELECTRIC EUROPE B.V. GERMAN BRANCH

Herzog-Carl-Strasse 4 D-73760 Ostfildern (Scharnhauser Park)
Phone : 49-711-4560-02-1
Fax : 49-711-4560-02-299
<http://www.hirose.de>

THE NETHERLANDS:

HIROSE ELECTRIC EUROPE B.V.

Hogehillweg #8 1101 CC Amsterdam Z-0
Phone : 31-20-6557460
Fax : 31-20-6557469
<http://www.hiroseeurope.com>

UK:

HIROSE ELECTRIC EUROPE B.V. UK BRANCH

First Floor, St Andrews House, Caldecotte Lake Business Park, Milton Keynes MK7 8LE
Phone : 44-1908-369060
Fax : 44-1908-369078
<http://www.hirose.co.uk>

CHINA:

HIROSE ELECTRIC CO., LTD. BEIJING REPRESENTATIVE OFFICE

A1001, Ocean International Center, Building 56# East 4th Ring Middle Road, Chao Yang District, Beijing, 100025
Phone : 86-10-5165-9332
Fax : 86-10-5908-1381
<http://www.hirose-china.com.cn>

CHINA:

HIROSE ELECTRIC (SHANGHAI) CO., LTD.

1501-02, Cross Tower Building, 318 Fuzhou Road, Huang Pu District, Shanghai 200001
Phone : 86-21-6391-3355
Fax : 86-21-6335-0767
<http://www.hirose-china.com.cn>

CHINA:

HIROSE ELECTRIC CO., LTD. SHENZHEN OFFICE

Room 09-13, 19/F, Office Tower Shun Hing Square, Di Wang Commercial Centre 5002, ShenNanDong Road, ShenZhen City, Guangdong Province, 518008
Phone : 86-755-8207-0851
Fax : 86-755-8207-0873
<http://www.hirose-china.com.cn>

HONG KONG:

HIROSE ELECTRIC HONGKONG TRADING CO., LTD.

Unit 1102 A&B, Energy Plaza, 92 Granville Road, Tsim Sha Tsui East, Kowloon
Phone : 852-2803-5338
Fax : 852-2591-6560
<http://www.hirose-hongkong.com.hk>

TAIWAN:

HIROSE ELECTRIC TAIWAN CO., LTD.

103 8F, No.87, Zhengzhou Rd., Taipei
Phone : 886-2-2555-7377
Fax : 886-2-2555-7350
<http://www.hirose-taiwan.com.tw>

SINGAPORE:

HIROSE ELECTRIC CO., LTD.

10 Anson Road #26-16 International Plaza 079903
Phone : 65-6324-6113
Fax : 65-6324-6123
<http://www.hirose-singapore.com.sg>

KOREA:

HIROSE KOREA CO., LTD.

1261-10, Jeoungwhang-Dong, Shihung-City, Kyunggi-Do 429-450
Phone : 82-31-496-7000,7124
Fax : 82-31-496-7100
<http://www.hirose.co.kr>



HIROSE ELECTRIC CO.,LTD.

5-23,OSAKI 5-CHOME,SHINAGAWA-KU,TOKYO 141-8587,JAPAN
PHONE: 81-3-3491-5300, FAX: 81-3-3495-5230
<http://www.hirose.com>
<http://www.hirose-connectors.com>
