

# **A-BRIGHT** A-BRIGHT INDUSTRIAL CO., LTD. SURFACE MOUNT CHIP LED LAMPS

## TOP View LEDs

Part Number: 67-21SUGC

## Package outlines & Re-flow Profile

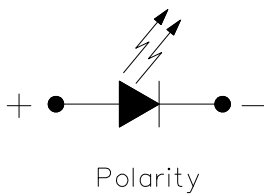
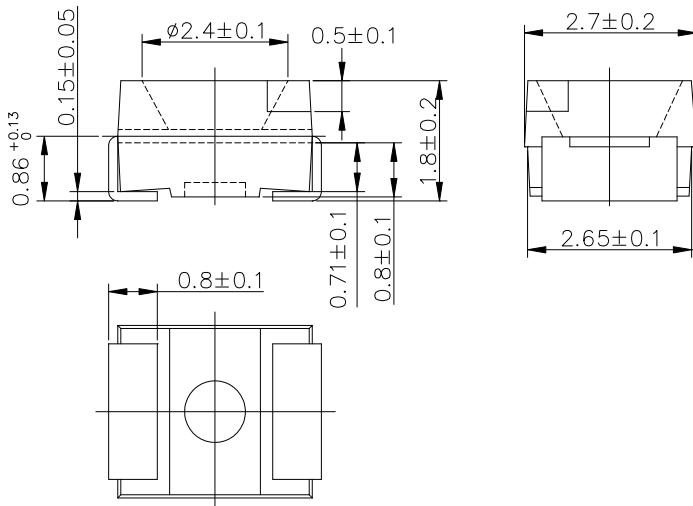
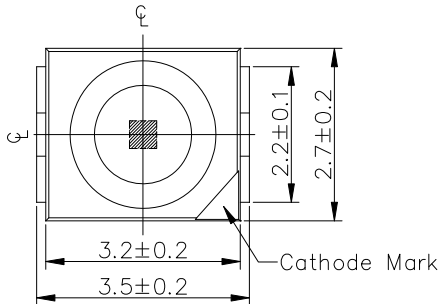

For Reflow Soldering

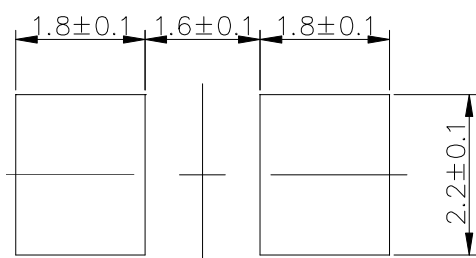

### Reflow Temp/Time

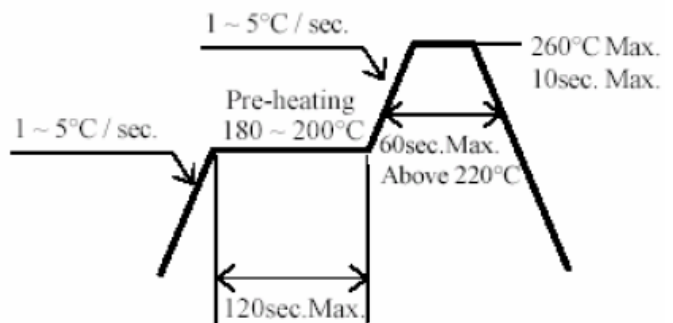

### Soldering iron

Basic spec is  $\leq 5\text{sec}$  when  $260^\circ\text{C}$ . If temperature is higher, time should be shorter ( $+10^\circ\text{C} \rightarrow -1\text{sec}$ ). Power dissipation of iron should be smaller than  $15\text{W}$ , and temperatures should be controllable. Surface temperature of the device should be under  $230^\circ\text{C}$ .

ITEM	MATERIALS
Resin (mold)	Epoxy
Lens color	Water Clear
Printed circuit board	BT
Material	InGaN
Emitted color	Super Green

### NOTES:

- All dimensions are in millimeters (inches).
- Tolerances are  $\pm 0.1\text{mm}$  ( $0.004\text{inch}$ ) unless otherwise noted.
- Polarity referring onto the cathode mark is reversed on the red.

# **A-BRIGHT** A-BRIGHT INDUSTRIAL CO., LTD. SURFACE MOUNT CHIP LED LAMPS

Part Number: 67-21SUGC

## ELECTRO-OPTICAL CHARACTERISTICS

( $T_A=25^{\circ}\text{C}$ )

Parameter	Test Condition	Symbol	Value			Unit
			MIN.	TYP.	MAX.	
Forward voltage	$I_F=20\text{mA}$	$V_F$	—	3.2	3.5	V
Luminous intensity	$I_F=20\text{mA}$	$I_V$	—	280	—	mcd
Peak Wavelength	$I_F=20\text{mA}$	$\lambda_p$	—	530	—	nm
Dominant Wavelength	$I_F=20\text{mA}$	$\lambda_d$	—	525	—	nm
Spectral Line Half-Width	$I_F=20\text{mA}$	$\Delta\lambda$	—	35	—	nm
Peak pulsing current (1/10 duty f=1kHz)		$I_{FP}$		100		mA
Power Dissipation		$P_D$		110		mW
Reverse current	$V_R=5\text{V}$	$I_R$		50		$\mu\text{A}$
Electrostatic Discharge		ESD		150		mA

## Absolute maximum ratings

( $T_A=25^{\circ}\text{C}$ )

Parameter	Symbol	Value	Unit
Viewing angle at 50% $I_V$	$2\theta_{1/2}$	120	Deg
Forward current	$I_F$	25	mA
Reverse voltage	$V_R$	5	V
Operating temperature range	Top	-40 ~ +85	$^{\circ}\text{C}$
Storage temperature range	Tstg	-40 ~ +100	$^{\circ}\text{C}$

**A-BRIGHT** A-BRIGHT INDUSTRIAL CO., LTD.  
**SURFACE MOUNT CHIP LED LAMPS**

Part Number: 67-21SUGC

**Test items and results of reliability**

NO	Item	Test Conditions	Test Hours/Cycle	Sample Size	Ac/Re
1	Reflow	TEMP : 240±5°C Min. 5sec.	6 MIN.	22 PCS	0/1
2	Temperature Cycle	H : +100°C 15min ∫ 5min L : -40°C 15min	300 CYCLES	22 PCS	0/1
3	Thermal Shock	H : +100°C 5min ∫ 10set L : -10°C 5min	300 CYCLES	22 PCS	0/1
4	High Temperature Storage	TEMP : 100°C	1000 HRS	22 PCS	0/1
5	Low Temperature Storage	TEMP : -55°C	1000 HRS	22 PCS	0/1
6	DC Operating Life	I <sub>F</sub> =20mA	1000 HRS	22 PCS	0/1
7	High Temperature / High Humidity	85°C / 85%RH	1000 HRS	22 PCS	0/1

\* Refer to reliability test standard specification for in this line.

**SURFACE MOUNT CHIP LED LAMPS**

Part Number: 67-21SUGC

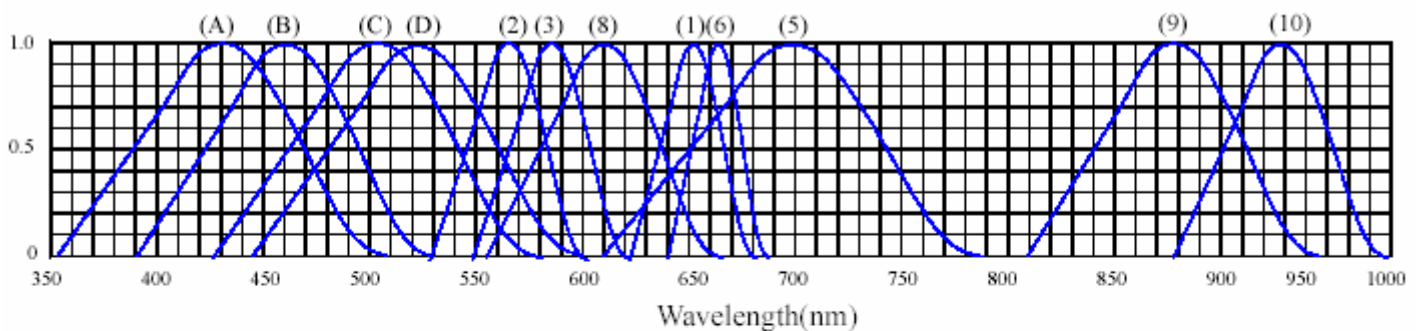
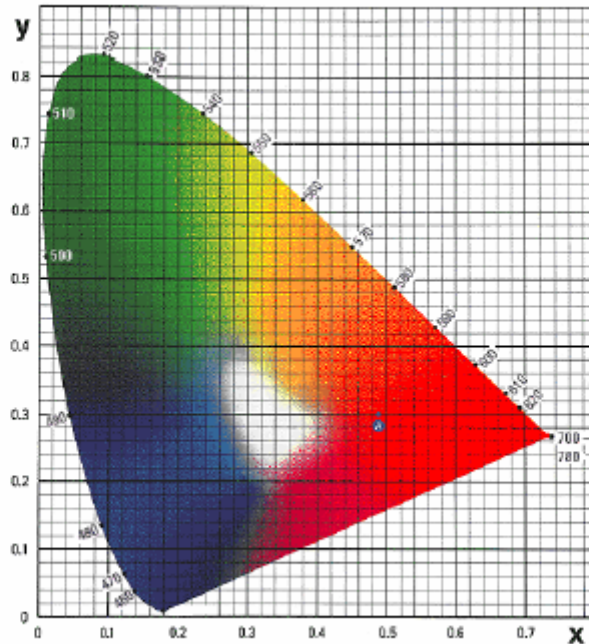
**Typical Electro-Optical Characteristics**◆ **TYPICAL ELECTRICAL-OPTICAL CHARACTERISTICS CURVES**

- (1) GaAsP/GaAs 655nm/Red
- (2) GaP 568nm/ Yellow Green
- (3) GaAsP/GaP 585nm/Yellow
- (4) GaAsP/GaP 635nm/Orange & Hi-Eff Red
- (5) GaP 700nm/Bright Red
- (6) GaAlAs/GaAs 660nm/Super Red
- (8) GaAsP/GaP 610nm/Super Red

- (9)- GaAlAs 880nm
- (10)-GaAs/GaAs&GaAlAs/GaAs 940nm
- (A)- GaN 430nm/Blue
- (B)- InGaN 470nm/Blue
- (C)- InGaN 502nm/Ultra Green
- (D)- InGaN 523nm/Ultra Green

**SURFACE MOUNT CHIP LED LAMPS**

Part Number: 67-21SUGC

**Typical Electro-Optical Characteristics**◆ **CHARACTERISTICS DIAGRAMS**

FORWARD CURRENT VS. FORWARD VOLTAGE

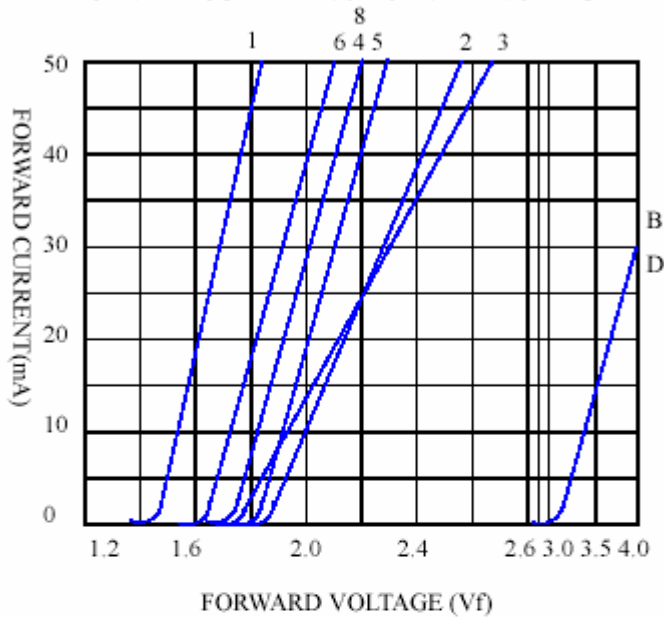

RELATIVE LUMINOUS INTENSITY VS. FORWARD CURRENT

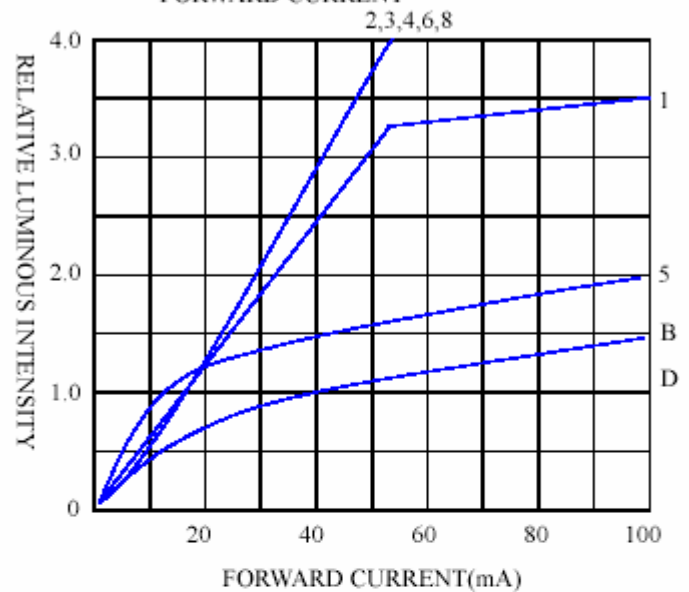

FORWARD CURRENT VS. AMBIENT TEMPERATURE

