

SILICON MMIC L BAND DOWNCONVERTER

FEATURES

- WIDE BAND OPERATION UP TO 2.5 GHz
- INTERNAL BALANCED AMPLIFIER FOR VCO
- SINGLE ENDED PUSH-PULL IF AMPLIFIER
- 5 V SINGLE SUPPLY VOLTAGE:
I_{CC} = 30 to 35 mA
- LOW CURRENT DISSIPATION
- TAPE AND REEL PACKAGING OPTION AVAILABLE

DESCRIPTION

The UPC2721GV is a L-Band frequency converter manufactured using the NESAT III MMIC process. This product consists of a double balanced mixer, local oscillator, IF preamplifier, and constant voltage generator. It is available in a 8 pin SSOP package. This device is designed for low cost cellular radios, GPS receivers, PCS, and UHF TV tuner applications.

The UPC2721 output amplifier is a single-end push-pull amplifier designed for operation into a 50 Ω load.

NEC's stringent quality assurance and test procedures ensure the highest reliability and performance.

INTERNAL BLOCK DIAGRAM

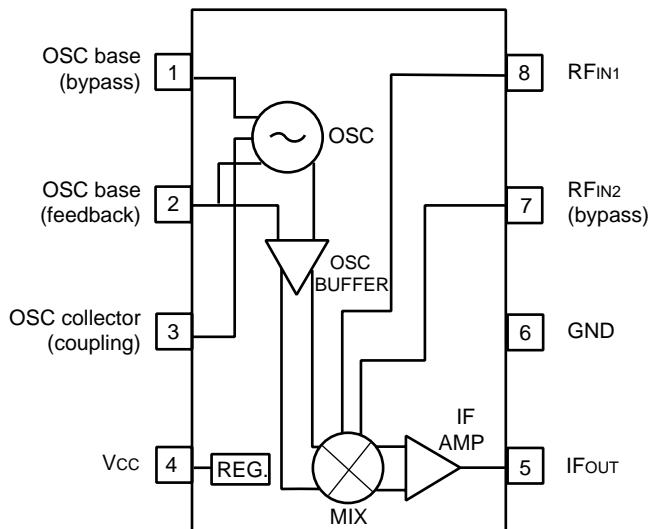

ELECTRICAL CHARACTERISTICS (T_A = 25°C, V_{CC} = 5 V, P_{LO} = -10 dBm)

PART NUMBER PACKAGE OUTLINE		UPC2721GV S08			
SYMBOLS	PARAMETERS AND CONDITIONS	UNITS	MIN	TYP	MAX
I _{CC}	Circuit Current	mA	29	38	45.5
f _{RF}	RF Frequency Range	GHz	0.9		2.0
f _{IF}	IF Frequency Range	MHz	50		600
CG	Conversion Gain ² f _{RF} = 900 to 2000MHz, f _{IF} = 50 to 400 MHz f _{IF} = 400 to 400 MHz	dB	18	21	24
		dB		22	
		dB		19.5	
PSAT	Saturated Output Power ² f _{RF} = 800 to 2000 MHz, f _{IF} = 400 MHz	dBm	2	7	
		dBm		7	
NF	Noise Figure ² f _{RF} = 900 MHz, f _{IF} = 400 MHz, f _{RF} = 2.0 GHz, f _{IF} = 400 MHz	dB		9	13
		dB		11	15
IP ₃	SSB Third Order Intercept Point, f ₁ = 900 MHz, f ₂ = 938 MHz f ₁ = 2.0 GHz, f ₂ = 2.038 GHz	dBm		+10	
		dBm		+8.5	

Notes:

1. Mounted on a 50 x 50 x 1.6 mm thick glass epoxy board with double sided copper.
2. Minimum and maximum specifications for CG and PSAT are measured at f_{RF} = 900 MHz and 2.0 GHz and at f_{IF} = 402.8 MHz.

The information in this document is subject to change without notice. Before using this document, please confirm that this is the latest version.

ABSOLUTE MAXIMUM RATINGS¹ (T_A = 25°C)

SYMBOLS	PARAMETERS	UNITS	RATINGS
V _{CC} ²	Supply Voltage	V	6
P _T ³	Power Dissipation ³	mW	250
T _{OP}	Operating Temperature	°C	-40 to +85
T _{STG}	Storage Temperature	°C	-65 to +150

Notes:

1. Operation in excess of any one of these parameters may result in permanent damage.
2. Recommended operating V_{CC} range is 4.5 to 5.5 V MAX.
3. T_A = +85°C mounted on a 50 x 50 x 1.6 mm thick glass epoxy board with double sided copper.

TYPICAL PERFORMANCE CURVES (T_A = 25°C)

CIRCUIT CURRENT VS. SUPPLY VOLTAGE

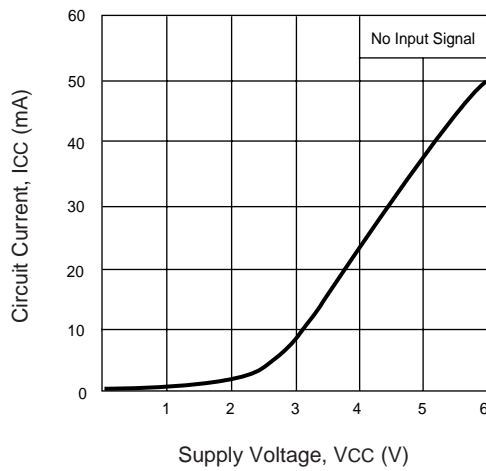

OUTPUT POWER VS. INPUT POWER

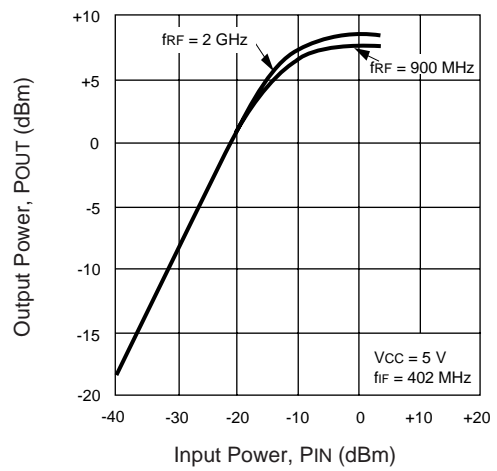

CONVERSION GAIN AND NOISE FIGURE vs. RF FREQUENCY

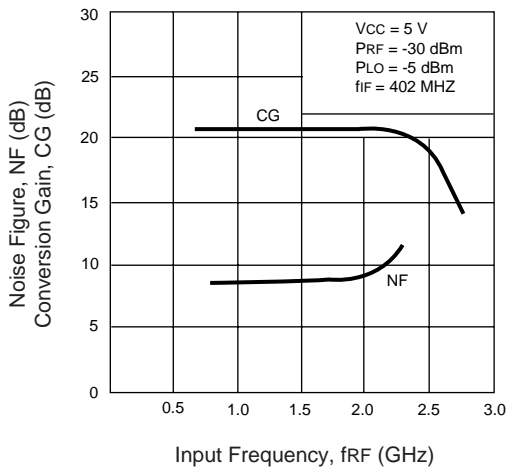

UPC2721 CONVERSION GAIN vs. IF FREQUENCY

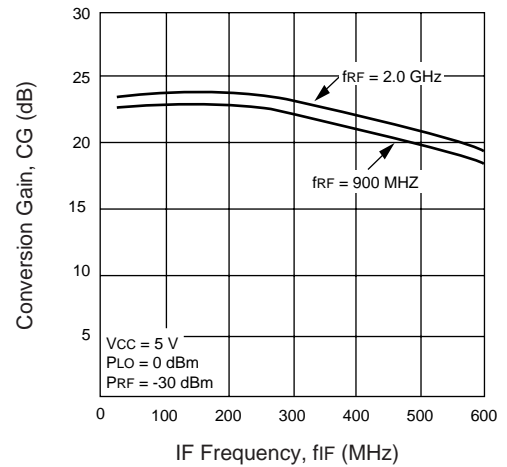

TYPICAL PERFORMANCE CURVES (TA = 25°C)

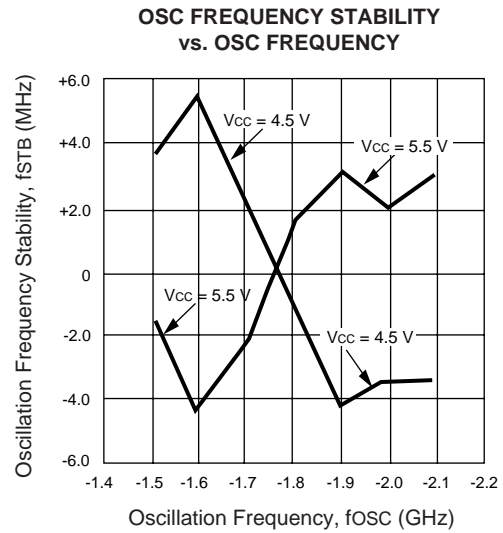
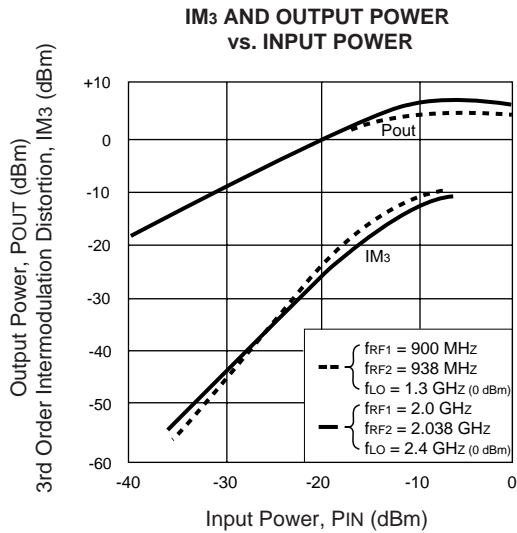

PIN DESCRIPTIONS

PIN NO.	SYMBOL	PIN VOLT TYP (V)	DESCRIPTION	EQUIVALENT CIRCUIT
1	OSC base (bypass)	2.9	Internal oscillator consists of a balance amplifier. Pin 2 and pin 3 should be externally equipped with a tank resonator circuit in order to oscillate with feedback loop. Pin 1 should be grounded through coupling capacitor ~0.5 pF. Pin 3 is an open collector. This pin should be coupled through resistor or choke coil in order to adjust Q and connect the supply voltage.	
2	OSC base (feedback)	2.9		
3	OSC collector (coupling)	5.0		
4	Vcc	5.0	Supply voltage pin for the IC.	
5	IF Output	2.9	The amplifier is designed as single-ended push-pull amplifier. This pin is an emitter follower output with a wideband 50 Ω impedance.	
6	GND	0.0	GND pin for the IC.	
7	RF input2 (bypass)	2.4	Pin 7 and pin 8 are inputs to a double-balanced mixer. Either pin can be assigned for input or ground.	
8	RF input1	2.4		

OUTLINE DIMENSIONS (Units in mm)

**UPC2721GV
PACKAGE OUTLINE S08**

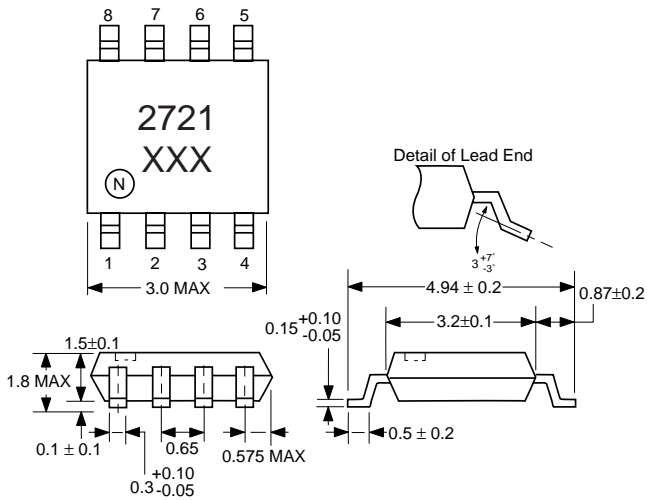

LEAD CONNECTIONS

1. OSC-Base (Bypass)
2. OSC-Base (Feed back)
3. OSC-Collector (Coupling)
4. Vcc
5. IF OUT
6. GND
7. RFIN2
8. RFIN1

Notes: Package will be marked as 2721 as shown.
All dimensions are typical unless otherwise specified.

Lead Material: Alloy 42
Lead Plating: Lead tin alloy

ORDERING INFORMATION (Solder Contains Lead)

PART NUMBER	QTY
UPC2721GV-E1	1000/Reel

ORDERING INFORMATION (Pb-Free)

PART NUMBER	QTY
UPC2721GV-E1-A	1000/Reel

Life Support Applications

These NEC products are not intended for use in life support devices, appliances, or systems where the malfunction of these products can reasonably be expected to result in personal injury. The customers of CEL using or selling these products for use in such applications do so at their own risk and agree to fully indemnify CEL for all damages resulting from such improper use or sale.

CEL California Eastern Laboratories, Your source for NEC RF, Microwave, Optoelectronic, and Fiber Optic Semiconductor Devices.
4590 Patrick Henry Drive • Santa Clara, CA 95054-1817 • (408) 919-2500 • FAX (408) 988-0279 • www.cel.com

DATA SUBJECT TO CHANGE WITHOUT NOTICE

Subject: Compliance with EU Directives

CEL certifies, to its knowledge, that semiconductor and laser products detailed below are compliant with the requirements of European Union (EU) Directive 2002/95/EC Restriction on Use of Hazardous Substances in electrical and electronic equipment (RoHS) and the requirements of EU Directive 2003/11/EC Restriction on Penta and Octa BDE.

CEL Pb-free products have the same base part number with a suffix added. The suffix –A indicates that the device is Pb-free. The –AZ suffix is used to designate devices containing Pb which are exempted from the requirement of RoHS directive (*). In all cases the devices have Pb-free terminals. All devices with these suffixes meet the requirements of the RoHS directive.

This status is based on CEL’s understanding of the EU Directives and knowledge of the materials that go into its products as of the date of disclosure of this information.

Restricted Substance per RoHS	Concentration Limit per RoHS (values are not yet fixed)	Concentration contained in CEL devices	
		-A	-AZ
Lead (Pb)	< 1000 PPM	Not Detected	(*)
Mercury	< 1000 PPM	Not Detected	
Cadmium	< 100 PPM	Not Detected	
Hexavalent Chromium	< 1000 PPM	Not Detected	
PBB	< 1000 PPM	Not Detected	
PBDE	< 1000 PPM	Not Detected	

If you should have any additional questions regarding our devices and compliance to environmental standards, please do not hesitate to contact your local representative.

Important Information and Disclaimer: Information provided by CEL on its website or in other communications concerning the substance content of its products represents knowledge and belief as of the date that it is provided. CEL bases its knowledge and belief on information provided by third parties and makes no representation or warranty as to the accuracy of such information. Efforts are underway to better integrate information from third parties. CEL has taken and continues to take reasonable steps to provide representative and accurate information but may not have conducted destructive testing or chemical analysis on incoming materials and chemicals. CEL and CEL suppliers consider certain information to be proprietary, and thus CAS numbers and other limited information may not be available for release.

In no event shall CEL’s liability arising out of such information exceed the total purchase price of the CEL part(s) at issue sold by CEL to customer on an annual basis.

See CEL Terms and Conditions for additional clarification of warranties and liability.