

Solid-state relays - ST-OV3-230AC/ 60DC/3 - 2903037

Please be informed that the data shown in this PDF Document is generated from our Online Catalog. Please find the complete data in the user's documentation. Our General Terms of Use for Downloads are valid (<http://phoenixcontact.com/download>)



Plug-in power solid-state relay, with LED and protective circuit in input and output circuits, input: 230 V AC, output: 12 - 60 V DC/max. 3 A, can be plugged into basic terminal blocks

The illustration shows version ST-OV
3- 5 DC/60 DC/3



Key commercial data

Packing unit	1 pc
GTIN	 4 017918 078881
Weight per Piece (excluding packing)	57.87 GRM
Custom tariff number	85364900
Country of origin	Germany

Technical data

Dimensions

Width	20.8 mm
Height	33 mm
Depth	66.5 mm

Ambient conditions

Ambient temperature (operation)	-20 °C ... 60 °C
Ambient temperature (storage/transport)	-20 °C ... 70 °C

Input data

Nominal input voltage U_N	230 V AC ± 20 %
Switching threshold "0" signal in reference to U_N	≤ 0.4
Switching threshold "1" signal in reference to U_N	≥ 0.8
Typical input current at U_N	4 mA

Solid-state relays - ST-OV3-230AC/ 60DC/3 - 2903037

Technical data

Input data

Typical response time	3 ms
Typical turn-off time	13 ms
Transmission frequency	10 Hz

Output data

Output voltage range	12 V DC ... 60 V DC
Limiting continuous current	3 A (see derating curve)
Surge current	5 A (t = 1 s)
Peak offstate voltage	70 V DC (Collector-emitter reverse voltage)
Voltage drop at max. limiting continuous current	1.2 V
Output circuit	2-wire, floating
Type of protection	Protection against polarity reversal
	Surge protection
Protective circuit/component	Polarity protection diode

General

Test voltage input/output	2.5 kV AC
Mounting position	any
Standards/regulations	IEC 60664
	IEC 60664 A
	DIN VDE 0110

Classifications

eCl@ss

eCl@ss 4.0	27371102
eCl@ss 4.1	27371102
eCl@ss 5.0	27371001
eCl@ss 5.1	27371001
eCl@ss 6.0	27371001
eCl@ss 7.0	27371001
eCl@ss 8.0	27371001

ETIM

ETIM 2.0	EC001504
ETIM 3.0	EC001504
ETIM 4.0	EC001504
ETIM 5.0	EC001504

Solid-state relays - ST-OV3-230AC/ 60DC/3 - 2903037

Classifications

UNSPSC

UNSPSC 6.01	30211916
UNSPSC 7.0901	39121542
UNSPSC 11	39121542
UNSPSC 12.01	39121542
UNSPSC 13.2	39121542

Approvals

Approvals

Approvals

GOST / GOST

Ex Approvals

Approvals submitted

Approval details

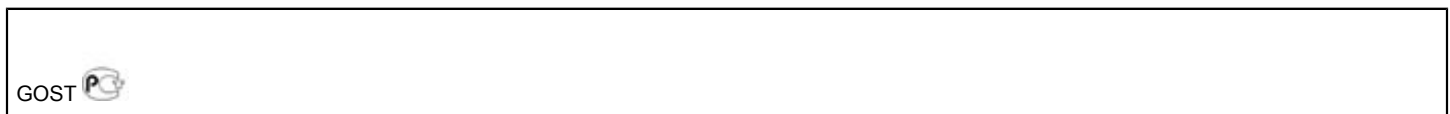

Drawings

Solid-state relays - ST-OV3-230AC/ 60DC/3 - 2903037

Diagram

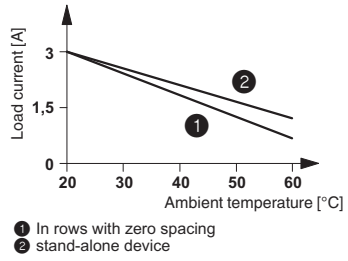

Circuit diagram

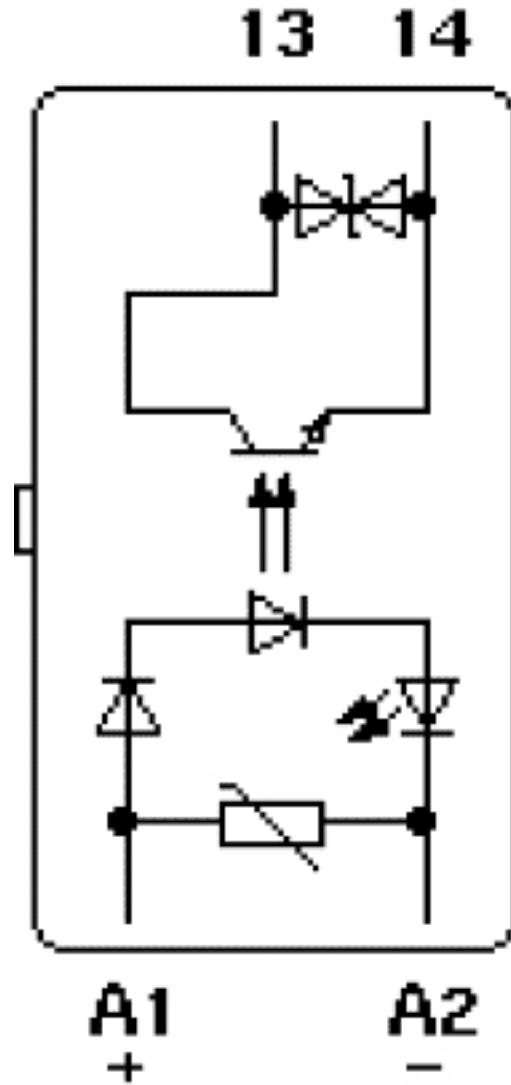

Solid-state relays - ST-OV3-230AC/ 60DC/3 - 2903037

Circuit diagram

