

**Number of Contacts**  
9, 15, 21, 25, 31, 37

**Filter Class**  
A, B, C, D, E, F or G  
(See Table II)

**Hardware Option**  
 NN - No Jackpost, No Threaded Insert  
 PN - Jackpost, No Threaded Insert  
 NU - Threaded Insert Only, No Jackposts  
 PU - Jackpost and Threaded Insert

**Rear Panel Jackposts with Threaded Insert:**  
 R6U - 0.125" (3.2) Panel  
 R5U - 0.094" (2.4) Panel  
 R4U - 0.062" (1.6) Panel  
 R3U - 0.047" (1.2) Panel  
 R2U - 0.031" (0.8) Panel

D

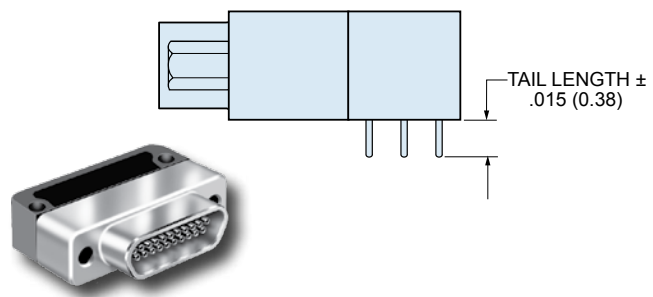
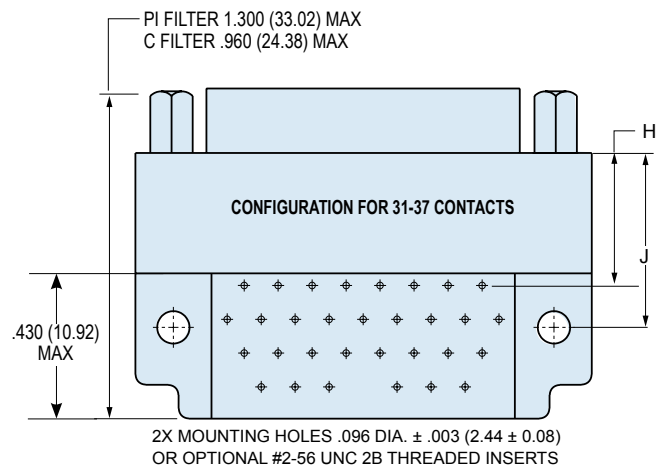
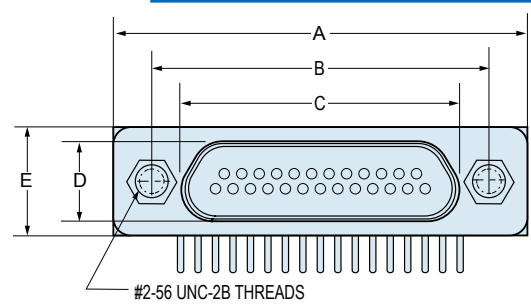
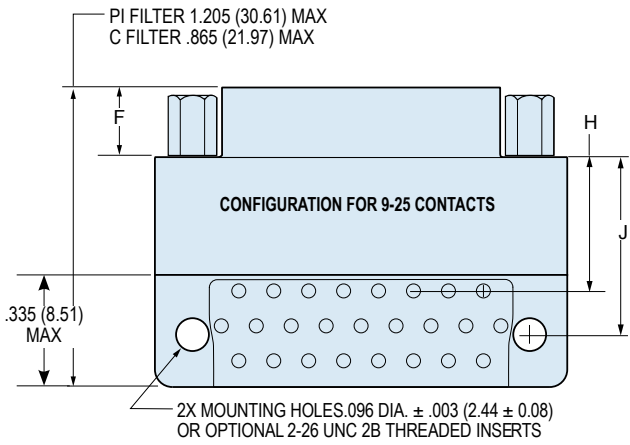

**Right Angle Board Mount Filtered Micro-D's.** These connectors feature low-pass EMI filtering in a right angle header for PCB termination.

**.100" x .100" Board Spacing**—These connectors are similar to "CBR" style Micro-D's and share the same board footprint, allowing retrofit to existing boards.

**240-034**  
**Micro-D Filter Connectors**  
**Right Angle Printed Circuit Board**



**TABLE I: SHELL FINISH**

SYM	MATERIAL	FINISH DESCRIPTION
1	Aluminum	Cadmium
2	Aluminum	Nickel
5	Aluminum	Gold
6	Aluminum	Chem Film
33	Aluminum	Ni-PTFE 1000 Hour Grey™

**TABLE II: CAPACITOR ARRAY CODE CAPACITANCE RANGE\***

CLASS	PI - CIRCUIT (pF)	C - CIRCUIT (pF)
A	38,000 - 56,000	19,000 - 28,000
B	32,000 - 45,000	16,000 - 22,500
C	18,000 - 33,000	9,000 - 16,500
D	8,000 - 12,000	4,000 - 6,000
E	3,300 - 5,000	1,650 - 2,500
F	800 - 1,300	400 - 650
G	400 - 600	200 - 300

**MICRO-D FILTER CLASSES AND PERFORMANCE**

Filter Class →	A	B	C	D	E	F	G									
<b>Capacitance, Picofarads (pF)</b>																
<b>C Filter</b>	19000-28000	16000-22500	9000-16500	4000-6000	1650-2500	400-650	200-300									
<b>Pi Filter</b>	38000-56000	32000-45000	18000-33000	8000-12000	3300-5000	800-1300	400-600									
<b>Insertion Loss, dB Minimum, 25° C.</b>																
Filter Type →	C		Pi		C		Pi		C		Pi		C		Pi	
<b>1 MHz</b>	6	10	5	8	3	5	—	1	—	—	—	—	—	—	—	—
<b>10 MHz</b>	24	40	23	35	16	25	8	14	4	8	—	2	—	—	0.8	—
<b>100 MHz</b>	41	62	39	60	35	57	28	50	21	40	10	15	5	13	—	—
<b>500-1000 MHz</b>	50	66	49	62	46	60	41	58	34	52	23	32	17	22	—	—

**MICRO-D FILTER RIGHT ANGLE PCB CONNECTORS**

Layout	A Max.		B		C Max.		D Max.		E Max.		F		G Max.		C Filter				Pi Filter			
	In.	mm.	In.	mm.	In.	mm.	In.	mm.	In.	mm.	In.	mm.	In.	mm.	H		J		H		J	
															±.010	±0.25	±.010	±0.25	±.010	±0.25	±.010	±0.25
<b>9P</b>	.785	19.94	.565	14.35	.333	8.46	.184	4.67	.310	7.87	.183	4.65	.420	10.67	.440	11.18	.460	11.68	.740	18.80	.760	19.30
<b>9S</b>	.785	19.94	.565	14.35	.400	10.16	.250	6.35	.310	7.87	.195	4.95	.420	10.67	.440	11.18	.460	11.68	.740	18.80	.760	19.30
<b>15P</b>	.935	23.75	.715	18.16	.483	12.27	.184	4.67	.310	7.87	.183	4.65	.420	10.67	.340	8.64	.460	11.68	.640	16.26	.760	19.30
<b>15S</b>	.935	23.75	.715	18.16	.551	14.00	.250	6.35	.310	7.87	.195	4.95	.420	10.67	.340	8.64	.460	11.68	.640	16.26	.760	19.30
<b>21P</b>	1.085	27.56	.865	21.97	.633	16.08	.184	4.67	.310	7.87	.183	4.65	.420	10.67	.340	8.64	.460	11.68	.640	16.26	.760	19.30
<b>21S</b>	1.085	27.56	.865	21.97	.701	17.81	.250	6.35	.310	7.87	.195	4.95	.420	10.67	.340	8.64	.460	11.68	.640	16.26	.760	19.30
<b>25P</b>	1.185	30.01	.965	24.51	.733	18.62	.184	4.67	.310	7.87	.183	4.65	.420	10.67	.340	8.64	.460	11.68	.640	16.26	.760	19.30
<b>25S</b>	1.185	30.01	.965	24.51	.801	20.35	.250	6.35	.310	7.87	.195	4.95	.420	10.67	.340	8.64	.460	11.68	.640	16.26	.760	19.30
<b>31P</b>	1.335	33.91	1.115	28.32	.883	22.43	.184	4.67	.310	7.87	.183	4.65	.520	13.21	.340	8.64	.460	11.68	.640	16.26	.760	19.30
<b>31S</b>	1.335	33.91	1.115	28.32	.951	24.16	.250	6.35	.310	7.87	.195	4.95	.520	13.21	.340	8.64	.460	11.68	.640	16.26	.760	19.30
<b>37P</b>	1.485	37.72	1.265	32.13	1.033	26.24	.184	4.67	.310	7.87	.183	4.65	.520	13.21	.340	8.64	.460	11.68	.640	16.26	.760	19.30
<b>37S</b>	1.485	37.72	1.265	32.13	1.101	27.96	.250	6.35	.310	7.87	.195	4.95	.520	13.21	.340	8.64	.460	11.68	.640	16.26	.760	19.30

**PC Tail Diameter  $.018 \pm .002$  ( $0.46 \pm 0.05$ )**  
**Contact numbers shown are for pin connectors.**  
**Patterns shown are for connector mounting side of PC board.**

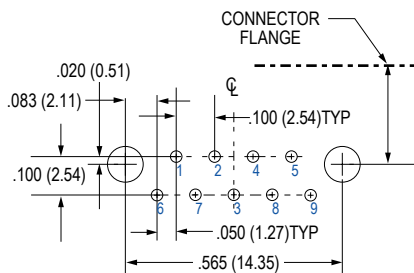

**9 Contacts**

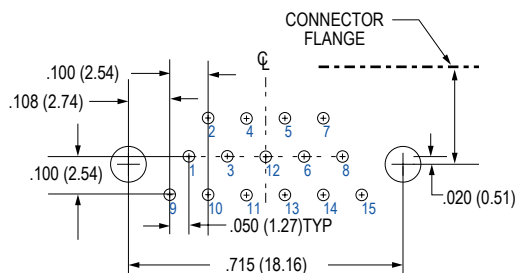

**15 Contacts**

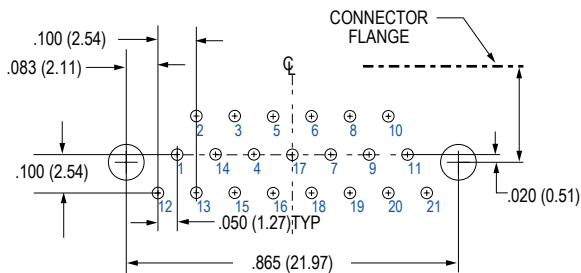

**21 Contacts**

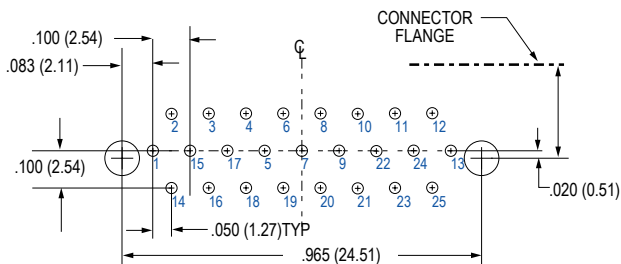

**25 Contacts**

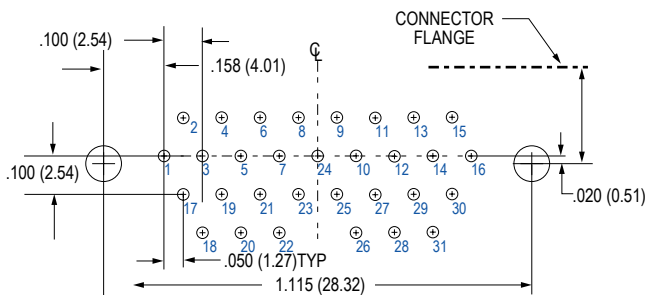

**31 Contacts**

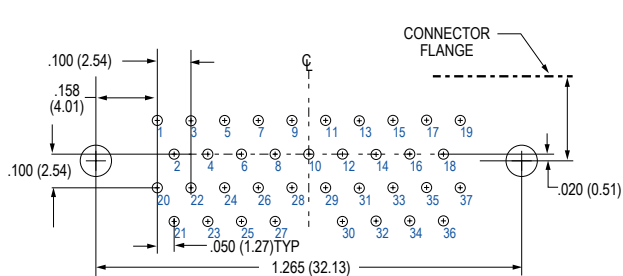

**37 Contacts**

**240-034**  
**Micro-D Filter Connectors**  
**Right Angle Printed Circuit Board Layouts**  
**Socket Connector**



**PC Tail Diameter  $.018 \pm .002$  ( $0.46 \pm 0.05$ )**  
**Contact numbers shown are for socket connectors.**  
**Patterns shown are for connector mounting side of PC board.**

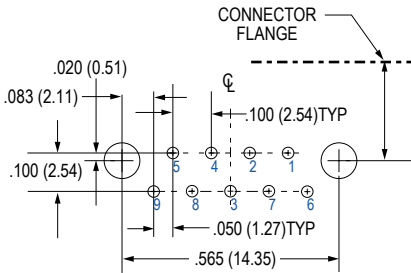

**9 Contacts**

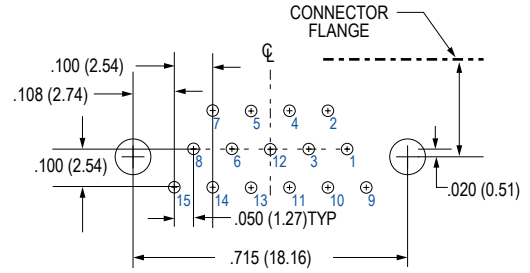

**15 Contacts**

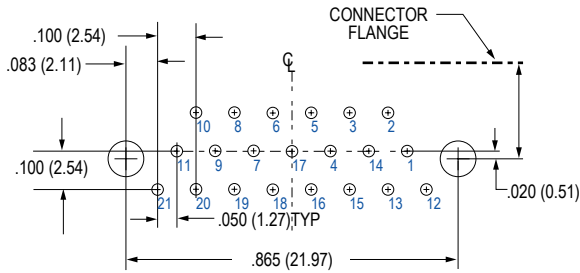

**21 Contacts**

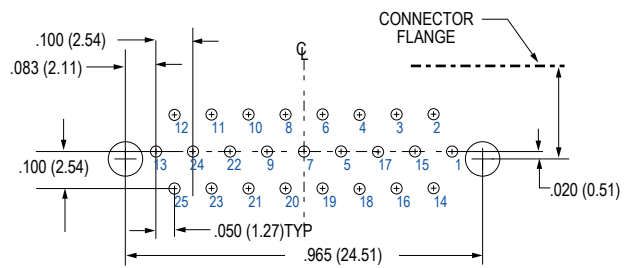

**25 Contacts**

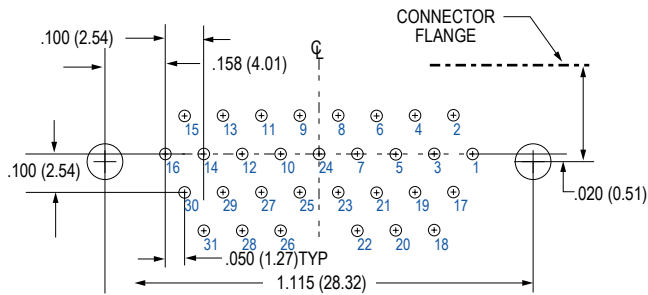

**31 Contacts**

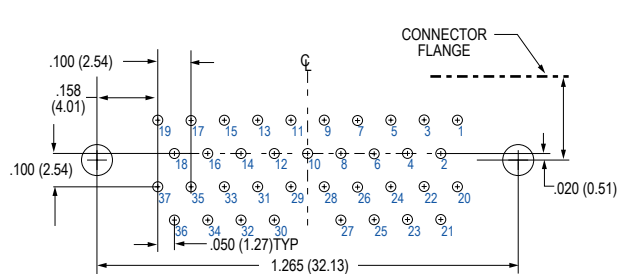

**37 Contacts**

