

PRODUCT NUMBER
90311-0XXLF

TOTAL NUMBER OF POS 04 UP TO 50

NOTES:

- 1 - MATERIAL : PA66 25% GLASSFILLED, UL94V-0 COLOR BLACK.
- 2 - SHEET 2 SHOWS THE SINGULAR LATCHING FEATURE FOR 2X2
- 3 - PRODUCT MEETS EUROPEAN UNION DIRECTIVES AND OTHERS REGULATIONS AS DESCRIBED IN GS-22-008.
- 4 - THIS PRODUCT IS NOT INTENDED TO BE EXPOSED TO MANUFACTURING SOLDER PROCESSES.
- 5 - CODING TRIANGLE INDICATES POS 1 WHEN MATED WITH MINITEK HEADER SERIES 98414 / 98417 / 98424 / 98464 / 10072354 / 10074920 AND 10075974.
- 6 - INDICATES POS 1, WHEN MATED WITH SERIES 90309 / 95609 / AND 95615.
- 7 - FOR USE WITH MINITEK CRIMP TO WIRE CONTACT 77138 (26-30AWG) AND 10044403 (22-24AWG).
- 8 - PRODUCT SPECIFICATION AS PER 110-036, CONTACT CRIMP RECOMMENDATIONS AS PER GS-20-058

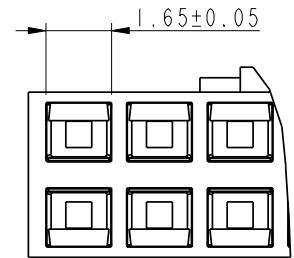
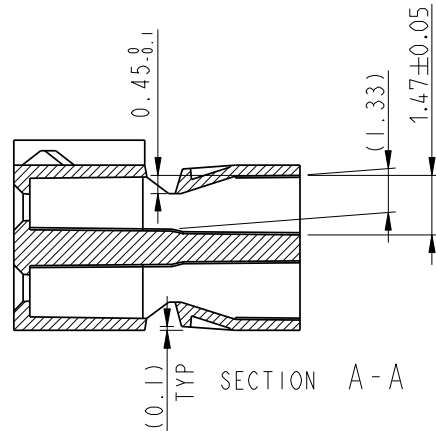
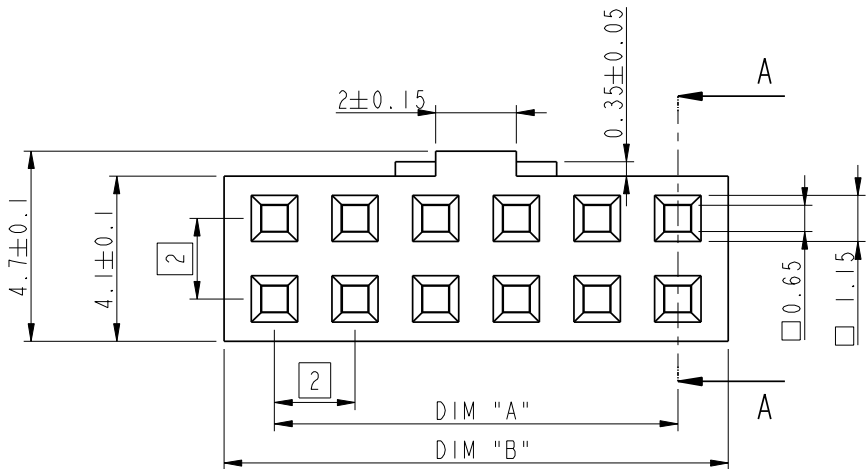
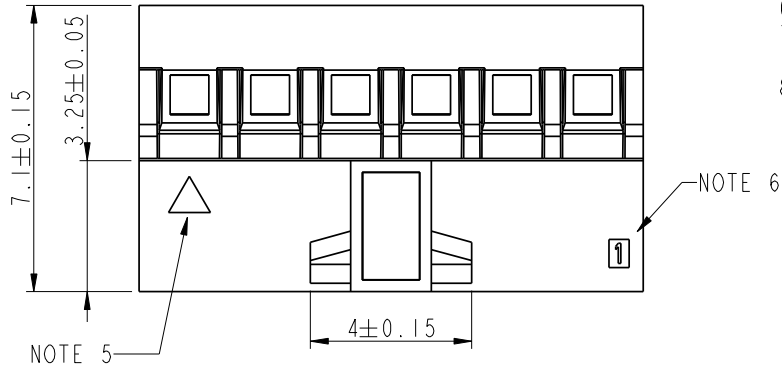

TOLERANCES UNLESS OTHERWISE SPECIFIED			
LINEAR	0.X	±0.3	-
	0.XX	±0.13	-
	0.XXX	±0.050	-
ANGULAR	0°	±2°	-

rev	ecn no	dr	date	Material	SEE NOTE 1	Spec ref	
T	V08-0392	HTB	2008-09-12	Mat code	N/A	✓	tolerance
U	F12-0004	JCO	2012-01-04	Heattreat	N/A		projection
V	F12-0073	JCO	2012-06-12	Plating/Finish	N/A		MM
Dr	D WHITING		1991-08-27	Product family	MINITEK	size	A3
Eng	S. OLSON		1991-08-27	Model Name	90311	Scale	8:1
Chr	J.COMPAGNON		11.12.01	Model Revision		REL Level	proi_release
Appr	JCO		11.12.01				
				FCI	Title	MINITEK CTW HSG.DBL ROW	
						POL & LATCHING, HIGH TEMPERATURE	
				Pro/E file	catalog no	CUSTOMER	sheet 1 of 2

PRODUCT NUMBER	SIZE	DIM A	DIM B
90311-004LF	2x2	2.0	4.4
90311-006LF	2x3	4.0	6.4
90311-008LF	2x4	6.0	8.4
90311-010LF	2x5	8.0	10.4
90311-012LF	2x6	10.0	12.4
90311-014LF	2x7	12.0	14.4
90311-016LF	2x8	14.0	16.4
90311-018LF	2x9	16.0	18.4
90311-020LF	2x10	18.0	20.4
90311-022LF	2x11	20.0	22.4
90311-024LF	2x12	22.0	24.4
90311-026LF	2x13	24.0	26.4
90311-028LF	2x14	26.0	28.4
90311-030LF	2x15	28.0	30.4
90311-032LF	2x16	30.0	32.4
90311-034LF	2x17	32.0	34.4
90311-036LF	2x18	34.0	36.4
90311-038LF	2x19	36.0	38.4
90311-040LF	2x20	38.0	40.4
90311-042LF	2x21	40.0	42.4
90311-044LF	2x22	42.0	44.4
90311-046LF	2x23	44.0	46.4
90311-048LF	2x24	46.0	48.4
90311-050LF	2x25	48.0	50.4

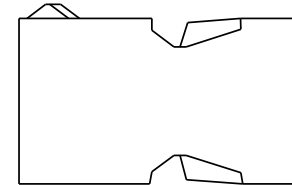
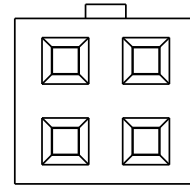
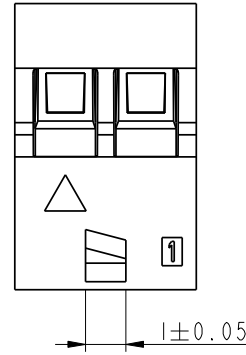

Material		Spec ref		
Mat code	Heattreat	✓	tolerance	projection
Plating/Finish				MM
Dr	D WHITING	1991-08-27		⊕
Eng	S. OLSON	1991-08-27	Product family	← →
Chr	J.COMPAGNON	11.12.01	Model Name	size A3
Appr	JCO	11.12.01	Model Revision	Scale 8:1
			Model Name	90311
			Model Revision	ECN
			REL Level	proi_release
	title	MINITEK CTW HSG.DBL ROW		Rev.
		POL & LATCHING, HIGH TEMPERATURE		W
Pro/E file	catalog no	CUSTOMER		sheet 2 of 2