

**PLEASE CHECK WWW.MOLEX.COM FOR LATEST PART INFORMATION**

**Part Number:** [0015977063](#)  
**Status:** **Active**  
**Overview:** [minifit\\_tpa](#)  
**Description:** 4.20mm (.165") Pitch Mini-Fit TPA™ Header, Dual Row, Vertical, with Snap-in Plastic Peg PCB Lock, 6 Circuits, Gold (Au) Plating, without Drain Holes

**Documents:**

[3D Model](#) [Product Specification PS-5556-003 \(PDF\)](#)  
[Drawing \(PDF\)](#) [RoHS Certificate of Compliance \(PDF\)](#)

**Agency Certification**

CSA LR19980  
TUV R72081037  
UL E29179

**General**

Product Family PCB Headers  
Series [30069](#)  
Application Wire-to-Board  
Comments Current = 13A max. per circuit when header is mated to a receptacle loaded with [45750](#) Mini-Fit Plus HCS™ Crimp Terminal Crimped to to 16 AWG wire. . See Molex product specification PS-45750-001 for additional current de-rating information.. Square Pin, Solder Type, High Vibration Application

Overview [minifit\\_tpa](#)  
Product Name Mini-Fit TPA™

**Physical**

Breakaway No  
Circuits (Loaded) 6  
Circuits (maximum) 6  
Color - Resin Black  
Durability (mating cycles max) 30  
First Mate / Last Break No  
Flammability 94V-0  
Glow-Wire Compliant No  
Guide to Mating Part No  
Keying to Mating Part None  
Lock to Mating Part Yes  
Material - Metal Brass  
Material - Plating Mating Tin  
Material - Plating Termination Tin  
Material - Resin Polyester  
Number of Rows 2  
Orientation Vertical  
PCB Locator Yes  
PCB Retention Yes  
PCB Thickness Recommended (in) 0.070 In  
PCB Thickness Recommended (mm) 1.80 mm  
Packaging Type Tray  
Pitch - Mating Interface (in) 0.165 In  
Pitch - Mating Interface (mm) 4.20 mm  
Pitch - Term. Interface (in) 0.165 In  
Pitch - Term. Interface (mm) 4.20 mm  
Plating min: Mating (µin) 35

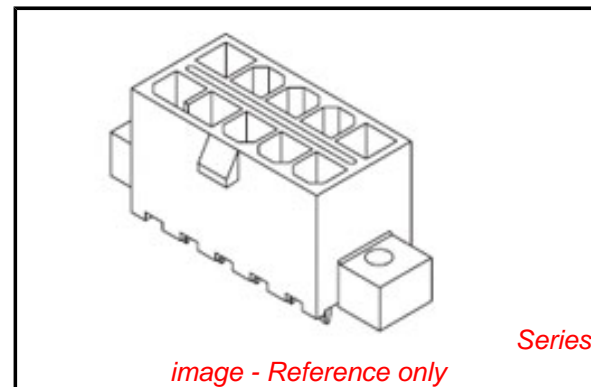

**EU RoHS**

**ELV and RoHS Compliant**  
**REACH SVHC**  
Not Reviewed  
**Halogen-Free Status**

**China RoHS**



**Not Halogen-Free**

**Need more information on product environmental compliance?**

Email [productcompliance@molex.com](mailto:productcompliance@molex.com)  
For a multiple part number RoHS Certificate of Compliance, [click here](#)

Please visit the [Contact Us](#) section for any non-product compliance questions.

**Search Parts in this Series**

[30069Series](#)

**Mates With**

[30067](#) Mini-Fit TPA™ Receptacle Housing

**Use With**

Mini-Fit TPA™ Receptacle Housing [30071](#) , [30072](#)

Plating min: Mating (µm)	0.90
Plating min: Termination (µin)	35
Plating min: Termination (µm)	0.90
Polarized to Mating Part	Yes
Polarized to PCB	Yes
Shrouded	Partial
Stackable	No
Surface Mount Compatible (SMC)	No
Temperature Range - Operating	-40°C to +105°C
Termination Interface: Style	Through Hole

### **Electrical**

Current - Maximum per Contact	13A
Voltage - Maximum	600V

### **Solder Process Data**

Duration at Max. Process Temperature (seconds)	5
Lead-free Process Capability	Wave Capable (TH only)
Max. Cycles at Max. Process Temperature	1
Process Temperature max. C	235

### **Material Info**

Old Part Number	30069-06C1
-----------------	------------

### **Reference - Drawing Numbers**

Product Specification	PS-5556-003
Sales Drawing	SDA-30069-****

This document was generated on 05/26/2010

**PLEASE CHECK [WWW.MOLEX.COM](http://WWW.MOLEX.COM) FOR LATEST PART INFORMATION**

NOTES:

- HOUSING MAT'L.: POLYESTER, UNFILLED, 94V-0. COLOR: BLACK.  
TERMINAL MATERIAL: BRASS ALLOY 260.
- PLATINGS:  
1 = .000035/(.00090) MIN. BRIGHT TIN OVER  
.000020/(.00050) MIN. COPPER.  
\*2 = .000030/(.00076) MIN. SELECT GOLD AND  
.000100/(.00254) MIN. SELECT MATTE TIN OVER  
.000050/(.00127) MIN. NICKEL OVERALL.  
\*THE PRIMARY SHIPPING CARTON WILL BE LABELED  
"COMPLIANT TO ROHS DIRECTIVE 2002/95/EC  
AND ELV ANNEX II OF DIRECTIVE 2000/53/EC."  
CARTONS WITHOUT THIS LABEL MAY CONTAIN  
PRODUCT WITH TIN-LEAD PLATING.
- PRODUCT SPECIFICATION AND PROCESSING PARAMETERS:  
SEE PS-5556-003
- PACKAGING SPECIFICATION: BULK PACKED
- PART IS DESIGNED FOR USE WITH 4-40 OR M3 SCREWS.
- PART MATES WITH RECEPTACLE 30067-\*
- THIS PART CONFORMS TO CLASS 'B' REQUIREMENTS OF COSMETIC  
SPECIFICATION PS-45499-002.

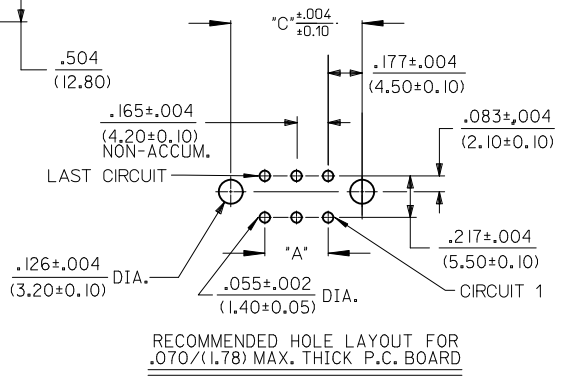
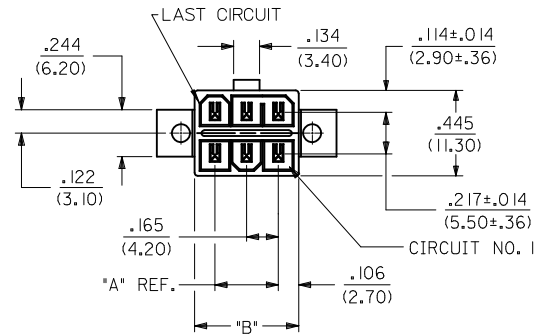
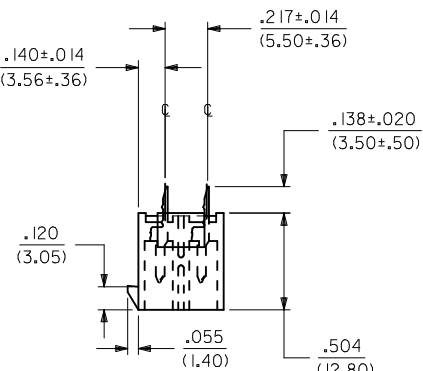
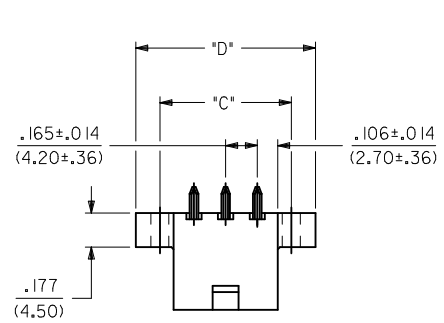

RECOMMENDED HOLE LAYOUT FOR  
.070/(1.78) MAX. THICK P.C. BOARD

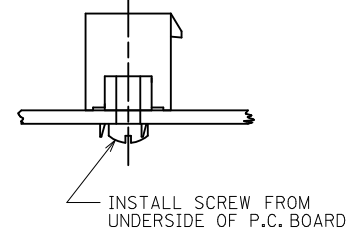

RECOMMENDED INSTALLATION  
OF HEADER TO P.C. BOARD

PCB LAYOUT FOR 2-16 CIRCUIT PARTS WITH FLANGES

LAYOUT FOR 18-24 CIRCUIT PARTS WITH FLANGES

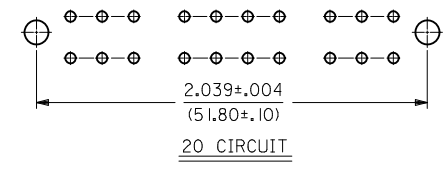
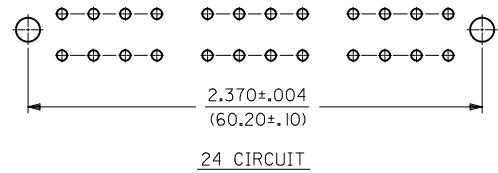
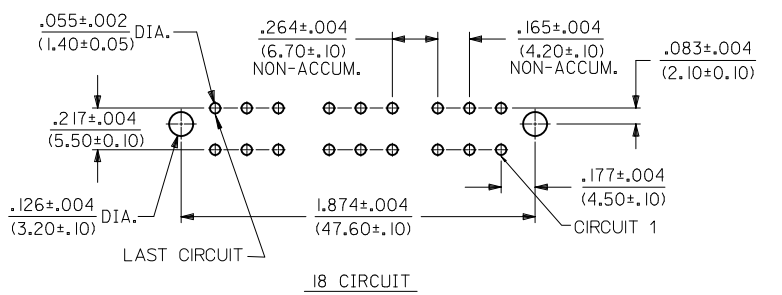

FLANGE MOUNT

(SEE SH. 2 FOR PARTS WITH PEGS)

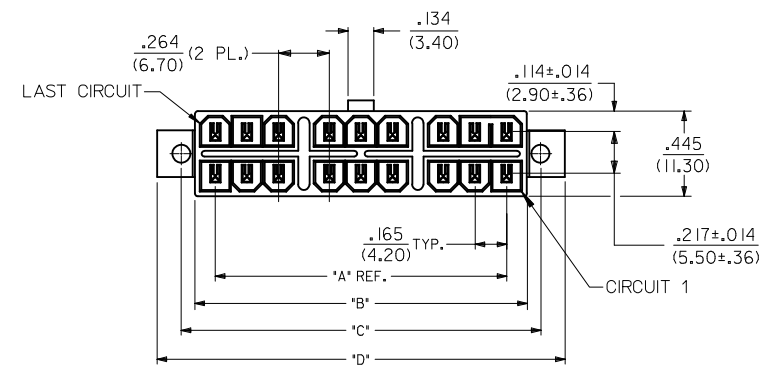

REMOVE DRAIN HOLES EC NO: UCP2009-1388 DRWNG:JKLOSTEN/ER 2008/11/25 CHKD:JBELL 2010/02/09 APPR:FSM/TH 2010/05/14 REV DESCRIPTION	QUALITY SYMBOLS	GENERAL TOLERANCES (UNLESS SPECIFIED)	DIMENSION STYLE	SCALE	DESIGN UNITS	THIRD ANGLE PROJECTION
	▽=0 ▽=0	mm      INCH 4 PLACES ± --- ± --- 3 PLACES ± --- ± .010 2 PLACES ± 0.25 ± .014 1 PLACE ± 0.36 ± --- ANGULAR ±1/2°	IN/MM	1:1	METRIC	
		DRAFT WHERE APPLICABLE MUST REMAIN WITHIN DIMENSIONS	DRAWN BY DATE	TITLE		
			RAS 9/19/91	MINI-FIT T.P.A. VERTICAL HEADER ASSEMBLY		
			APPROVED BY DATE	Molex MOLEX INCORPORATED		
			RAS 9/19/91	SDA-30069-****		
			MATERIAL NO.	DOCUMENT NO.	SHEET NO.	
			SEE CHARTS		1 OF 4	
			THIS DRAWING CONTAINS INFORMATION THAT IS PROPRIETARY TO MOLEX INCORPORATED AND SHOULD NOT BE USED WITHOUT WRITTEN PERMISSION			

LAYOUT FOR 18-24 CIRCUIT PARTS WITH PEGS

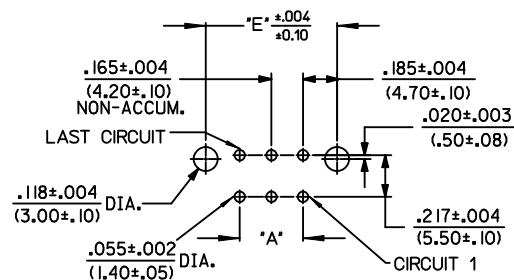
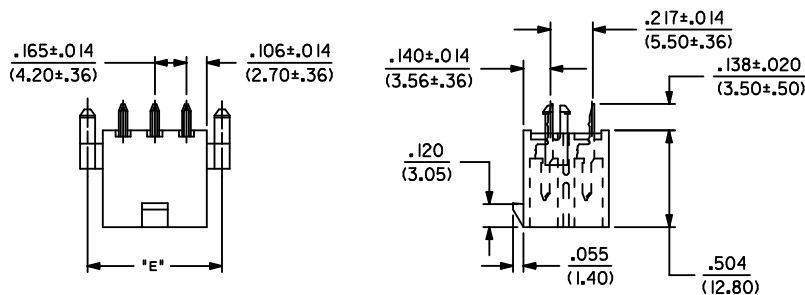
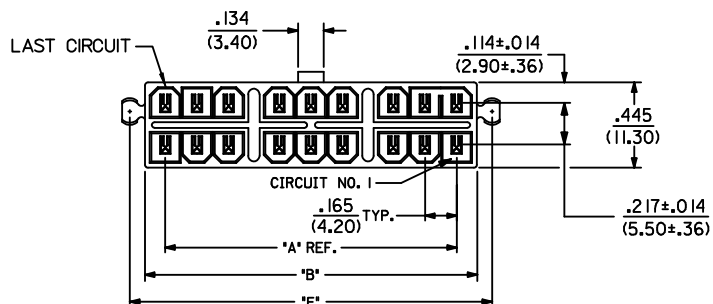
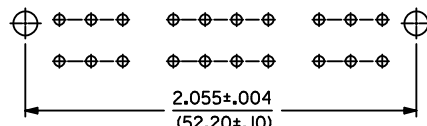
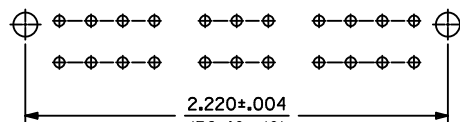
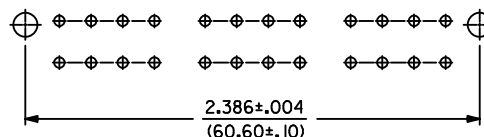
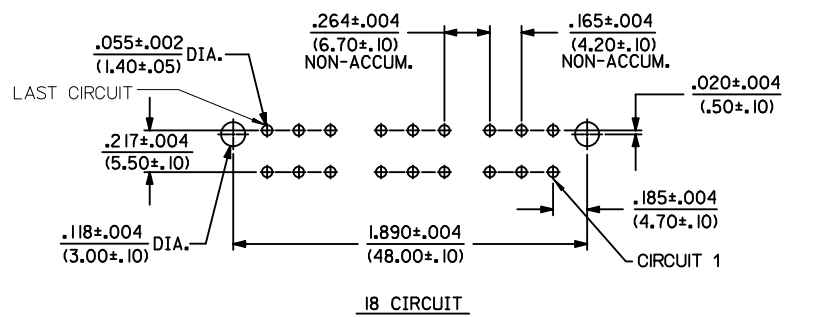

RECOMMENDED HOLE LAYOUT FOR  
 .070/(1.78) MAX. THICK P.C. BOARD  
 PCB LAYOUT FOR 2-16 CIRCUIT PARTS

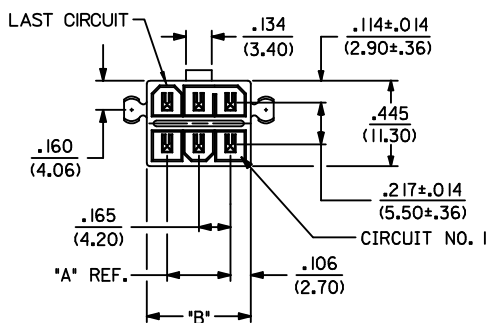

WITH PEGS

Correct peg-peg dim. EC NO: UCP2009-1388 DRAWN: KLOSTNER/ER 2008/11/25 CHKD: J.BELL 2010/02/09 APPR: F.SMITH 2010/05/14	DESCRIPTION	QUALITY SYMBOLS ▽=0 ▽=0
---	-------------	-------------------------------

GENERAL TOLERANCES (UNLESS SPECIFIED)	DIMENSION STYLE IN/MM	SCALE 1:1	DESIGN UNITS METRIC	THIRD ANGLE PROJECTION
4 PLACES ± --- ± ---	DRAWN BY R.J.F.	DATE 9/19/91	TITLE MINI-FIT T.P.A. VERTICAL HEADER ASSEMBLY	
3 PLACES ± --- ± .010	CHECKED BY GEP	DATE 9/19/91	MOLEX INCORPORATED	
2 PLACES ± 0.25 ± .014	APPROVED BY RAS	DATE 9/19/91	DOCUMENT NO. SDA-30069-****	
1 PLACE ± 0.36 ± ---	MATERIAL NO.		SHEET NO. 2 OF 4	
ANGULAR ± 1/2°	SEE CHARTS		THIS DRAWING CONTAINS INFORMATION THAT IS PROPRIETARY TO MOLEX INCORPORATED AND SHOULD NOT BE USED WITHOUT WRITTEN PERMISSION	
DRAFT WHERE APPLICABLE MUST REMAIN WITHIN DIMENSIONS				

TIN-PLATED ASSEMBLIES WITH PEGS, WITHOUT DRAIN HOLES.							GOLD-PLATED ASSEMBLIES WITH PEGS, WITHOUT DRAIN HOLES.					
CKT. SIZE	ENG. NO.	EDP. NO.	DIM. "A"	DIM. "B"	DIM. "E"	DIM. "D"	ENG. NO.	EDP. NO.	DIM. "A"	DIM. "B"	DIM. "E"	DIM. "D"
2	A-30069-02C1	15-97-7023	—	.213 (5.40)	.370 (9.40)	—	A-30069-02C2	15-97-7025	—	.213 (5.40)	.370 (9.40)	—
4	A-30069-04C1	15-97-7043	.165 (4.20)	.378 (9.60)	.535 (13.60)	—	A-30069-04C2	15-97-7045	.165 (4.20)	.378 (9.60)	.535 (13.60)	—
6	A-30069-06C1	15-97-7063	.331 (8.40)	.543 (13.80)	.701 (17.80)	—	A-30069-06C2	15-97-7065	.331 (8.40)	.543 (13.80)	.701 (17.80)	—
8	A-30069-08C1	15-97-7083	.496 (12.60)	.709 (18.00)	.866 (22.00)	—	A-30069-08C2	15-97-7085	.496 (12.60)	.709 (18.00)	.866 (22.00)	—
10	A-30069-10C1	15-97-7103	.661 (16.80)	.874 (22.20)	1.031 (26.20)	—	A-30069-10C2	15-97-7105	.661 (16.80)	.874 (22.20)	1.031 (26.20)	—
12	A-30069-12C1	15-97-7123	.827 (21.00)	1.039 (26.40)	1.197 (30.40)	—	A-30069-12C2	15-97-7125	.827 (21.00)	1.039 (26.40)	1.197 (30.40)	—
14	A-30069-14C1	NOT TOOLED	.992 (25.20)	1.205 (30.60)	1.362 (34.60)	—	A-30069-14C2	NOT TOOLED	.992 (25.20)	1.205 (30.60)	1.362 (34.60)	—
16	A-30069-16C1	NOT TOOLED	1.157 (29.40)	1.370 (34.80)	1.528 (38.80)	—	A-30069-16C2	NOT TOOLED	1.157 (29.40)	1.370 (34.80)	1.528 (38.80)	—
18	A-30069-18C1	NOT TOOLED	1.520 (38.60)	1.732 (44.00)	1.890 (48.00)	—	A-30069-18C2	NOT TOOLED	1.520 (38.60)	1.732 (44.00)	1.890 (48.00)	—
20	A-30069-20C1	NOT TOOLED	1.685 (42.80)	1.898 (48.20)	2.055 (52.20)	—	A-30069-20C2	NOT TOOLED	1.685 (42.80)	1.898 (48.20)	2.055 (52.20)	—
22	A-30069-22C1	NOT TOOLED	1.850 (47.00)	2.063 (52.40)	2.220 (56.40)	—	A-30069-22C2	NOT TOOLED	1.850 (47.00)	2.063 (52.40)	2.220 (56.40)	—
24	A-30069-24C1	NOT TOOLED	2.016 (51.20)	2.228 (56.60)	2.386 (60.60)	—	A-30069-24C2	NOT TOOLED	2.016 (51.20)	2.228 (56.60)	2.386 (60.60)	—

CKT. SIZE	ENG. NO.	EDP. NO.	DIM. "A"	DIM. "B"	DIM. "E"	DIM. "D"	ENG. NO.	EDP. NO.	DIM. "A"	DIM. "B"	DIM. "E"	DIM. "D"
2												
4												
6												
8												
10												
12												
14												
16												
18												
20												
22												
24												

**LEGEND:**

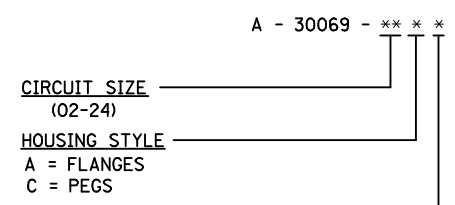

**PLATING (SEE SHT. 1, NOTE 6.)**  
 1 = TIN OVER COPPER.  
 2 = GOLD OVER NICKEL.

REV	DESCRIPTION
H	REMOVE DH P/N'S EC NO: UCP2009-1386 DRAWN: JLOSTNER/ER 2008/11/25 CHKD: JBEL 2010/02/09 APPR: FSM/TH 2010/05/14

<b>QUALITY SYMBOLS</b> 	<b>GENERAL TOLERANCES (UNLESS SPECIFIED)</b> <table border="1"> <tr> <th></th> <th>mm</th> <th>INCH</th> </tr> <tr> <td>4 PLACES</td> <td>± .005</td> <td>± .0004</td> </tr> <tr> <td>3 PLACES</td> <td>± .003</td> <td>± .0002</td> </tr> <tr> <td>2 PLACES</td> <td>± .002</td> <td>± .0001</td> </tr> <tr> <td>1 PLACE</td> <td>± .001</td> <td>± .00005</td> </tr> </table>		mm	INCH	4 PLACES	± .005	± .0004	3 PLACES	± .003	± .0002	2 PLACES	± .002	± .0001	1 PLACE	± .001	± .00005	<b>DIMENSION STYLE</b> IN/MM DRAWN BY DATE R/JF 9/19/91 CHECKED BY DATE GEP 9/19/91 APPROVED BY DATE RAS 9/19/91	SCALE 1:1 DESIGN UNITS METRIC THIRD ANGLE PROJECTION
		mm	INCH															
4 PLACES	± .005	± .0004																
3 PLACES	± .003	± .0002																
2 PLACES	± .002	± .0001																
1 PLACE	± .001	± .00005																
<b>DRAFT WHERE APPLICABLE MUST REMAIN WITHIN DIMENSIONS</b>	<b>SEE CHARTS</b>	TITLE <b>MINI-FIT T.P.A. VERTICAL HEADER ASSEMBLY</b> MATERIAL NO. SDA-30069-**** DOCUMENT NO. SDA-30069-**** SHEET NO. 4 OF 4	MOLEX INCORPORATED															

THIS DRAWING CONTAINS INFORMATION THAT IS PROPRIETARY TO MOLEX INCORPORATED AND SHOULD NOT BE USED WITHOUT WRITTEN PERMISSION