

Product Features

- GaN on SiC + Doherty Technology
- High Efficiency
- Solid-state Linear Design
- Small and Light Weight
- Suitable for WCDMA/LTE
- 50 Ohm Input/Output Impedance
- High Reliability and Ruggedness
- Built in Output Isolator

Application

- WCDMA / LTE Repeater



Description

This HPA Module is a high gain and compact amplifier module for WCDMA and LTE Repeater use.

Electrical Specifications

PARAMETER	Symbol	Specification		
Frequency Range	BW	2110 ~ 2170MHz		
Operating Bandwidth within BW	OBW	5 ~ 20MHz		
Output Power	Pout	40dBm/ WCDMA 4FA, LTE		
SPECTRUM EMISSION MASK (with DPD)	SEM	PER 3GPP TS-25.141 & TS25.141		
ACLR (WCDMA 4FA) @ Po=+40dBm (typ.)	ACLR	Non-DPD	-25dBc@±5MHz -28dBc@±10MHz	@-30 ~ +60°C @ 28V ~ 31V @ PAR 7.5dB
		With-DPD	-45dBc@±5MHz -48dBc@±10MHz	
ACLR (LTE 10MHz 1FA) @ Po=+40dBm (typ.)		Non-DPD	-28dBc@±10MHz	
		With-DPD	-52dBc@±10MHz	
RF Gain	G	45dB ±3dB @frequency range, 10W Pavg, -30 ~ +60°C		
Input Return Loss	S11	-16dB (Max.)		
Output Return Loss	S22	-18dB (Max.)		
Normal Operating Voltage	VDC	+5.6V~6V, +28V ~32V		
Current Consumption	IDD	0.12A / 5.6V, 0.865A / 28V (typ.)		
Efficiency	Eff	40%@28V(typ.)		
Gain Flatness	ΔG	Peak to peak 2dB Over operating frequency		
		Peak to peak 0.5dB Over any 3.84MHz		
Harmonics (2 nd , with DPD)	H	-45dBc (Max.)		
Feedback Output level @ 40dBm	FB	+2dBm ± 1dB		
Operating Temperature	To	-30°C ~ + 60°C (Ambient temp)		

Environmental Characteristics

Parameter	Symbol	Min.	Typ.	Max.	Unit
Operating Ambient Temperature	Ta	-30		+60	°C
Storage Temperature	Tstg	-40		+130	°C
Relative humidity w/o condensation	RH			95	%

Mechanical Specifications

Parameter	Value	Units	Limits
Dimensions	100.0 x 50.0 x 20.0	mm	
Weight	0.2(MAX)	Kg	
RF Input Connector	MCX(Female)		
RF Output Coupling Connector	MCX(Female)		
RF Output Connector	SMA(Female)		
DC Connector	Molex_4pin male (0022035045)		
Cooling	External Heat-sink		

Maximum Rating

Input Overdrive	P _{OD}	-2dBm	Max.
Load VSWR	Ψ	∞ : 1 (All Phase & Amplitude)	Nom.
Operating Case Temperature	T _c	+100	°C

Interface Connector

Connector type: MOLEX_4pin male (0022035045)

Pin #	Description	I/O	Specifications
1	VDC1	I	+5.6V
2, 3	VDC2	I	+28V
4	GND	-	Ground

Gain Budget & Block Diagram

GAIN(dB) :	-3dB	17dB	18dB	-3dB	15dB	1.3dB	-0.3dB	TOTAL
POWER :	-5dBm	-8dBm	9dBm	27dBm	24dBm	39dBm	40.3dBm	40dBm

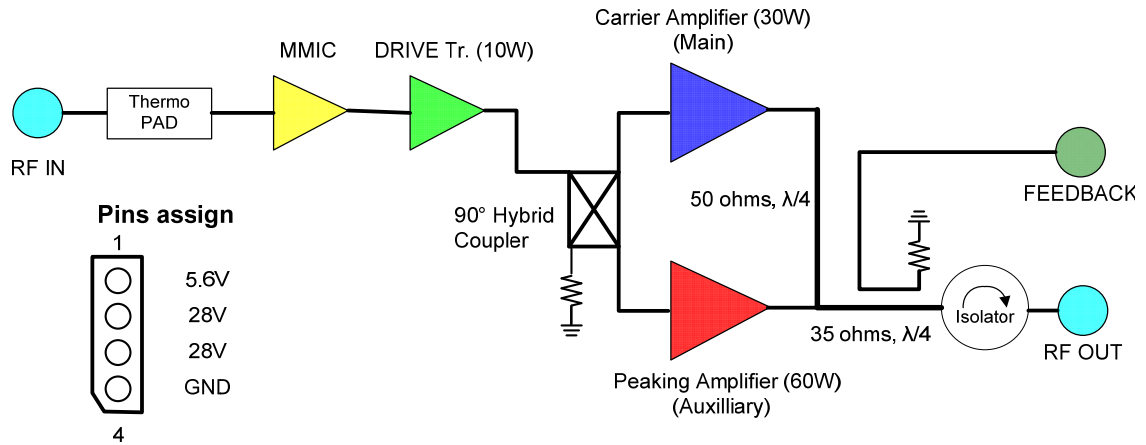

Outline Drawing

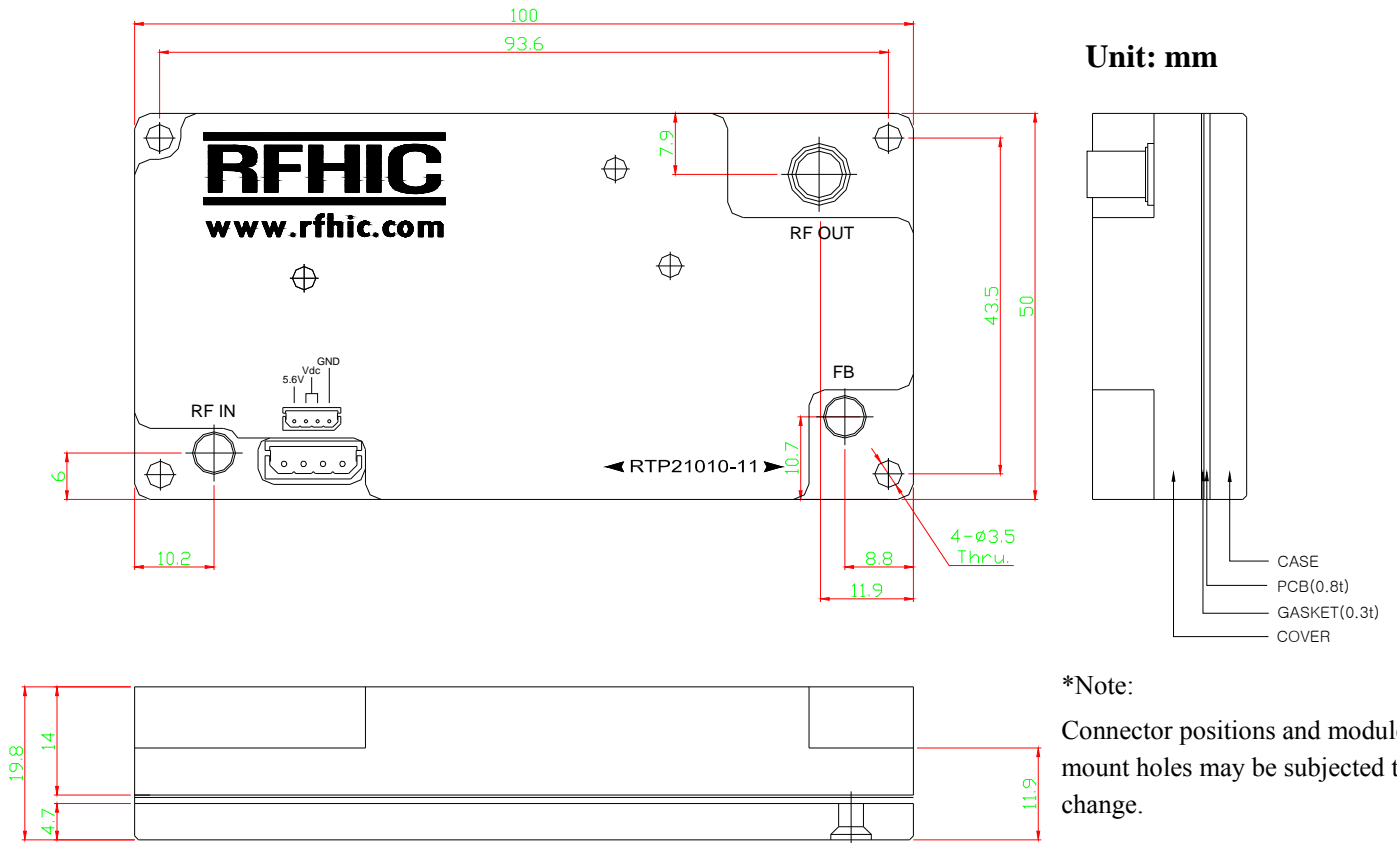

Photo of Product



Test Equipments:

- **DPD Engine : Optichron board (OP6180)**
- **Signal Generator: E4438C (Agilent)**
- **Spectrum Analyzer: E4440A (Agilent)**
- **Network Analyzer: 8753E (HEWLET PACKARD)**
- **Power Supply: IPS-30B05DD (INTERACT)**
- **RTP21010-11: (S/N: RTP21-11090001)**

Test Condition:

- **Signal: WCDMA 4FA (Test Model 1 W/ 64DPCH) & LTE 10MHz 1FA**
- **PAR: 7.5dB**
- **CFR apply**
- **Temperature: 25°C**
- **AMP Temperature: 35°C**

Test Data

GAIN & GAIN FLATNESS

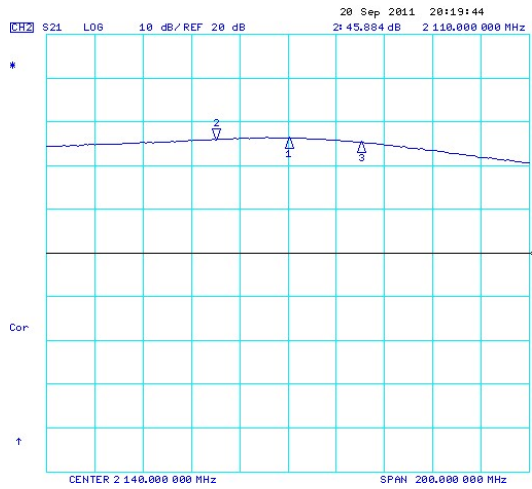

S11

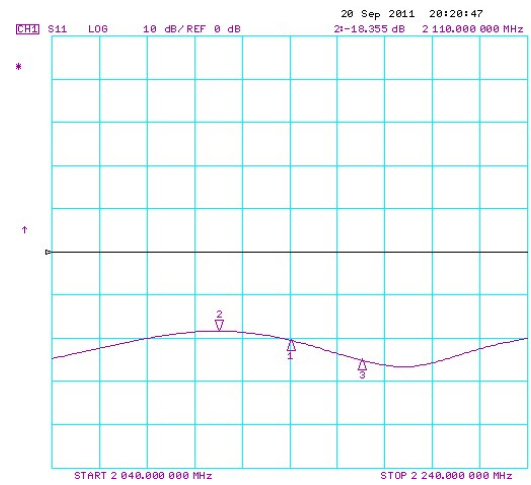

S22

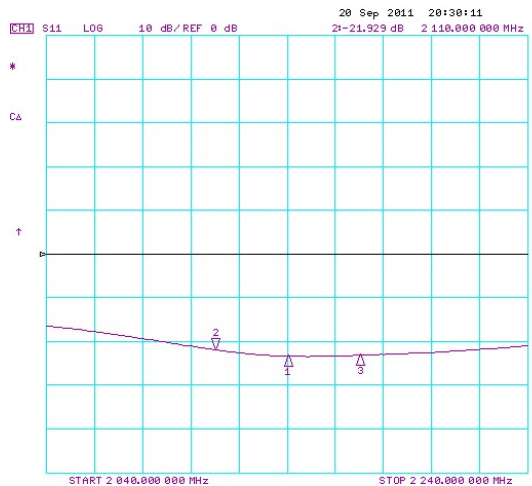

Psat = 48.5dBm@2120MHz (Pulse duty cycle 10%)

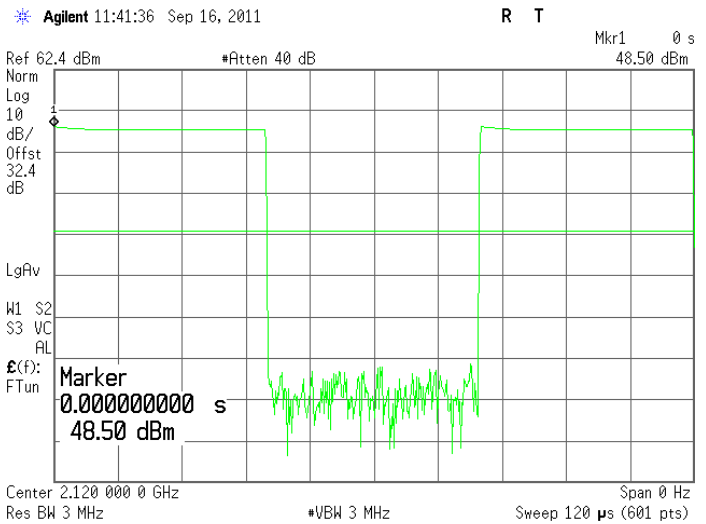

Psat = 48.5 dBm@2140MHz (Pulse duty cycle 10%)

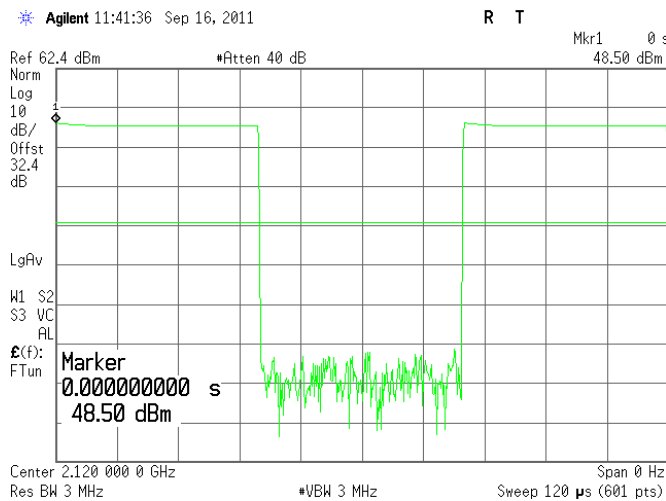

Psat = 48.18dBm@2160MHz (Pulse duty cycle 10%)

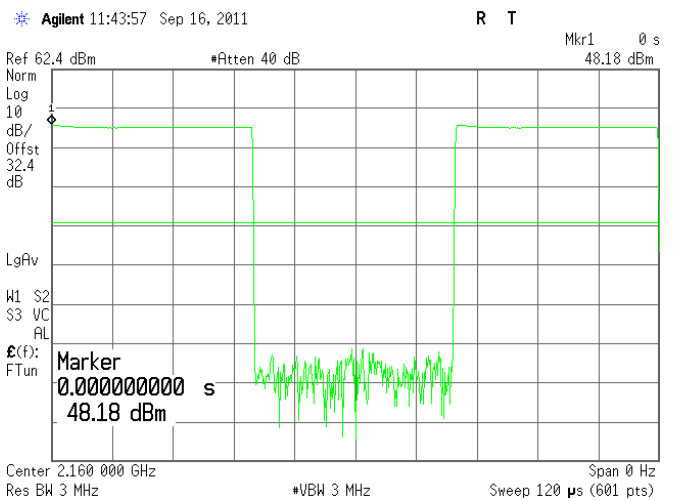

Test Results: DPD Operation (WCDMA 4FA)

Pre - DPD@2120MHz

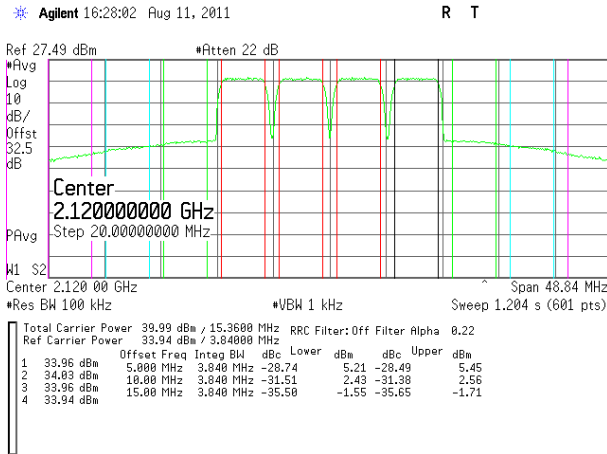

Post- DPD@2120MHz

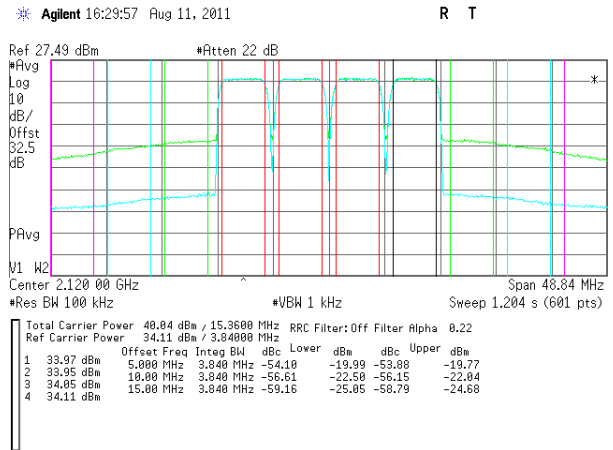

Pre - DPD@2140MHz

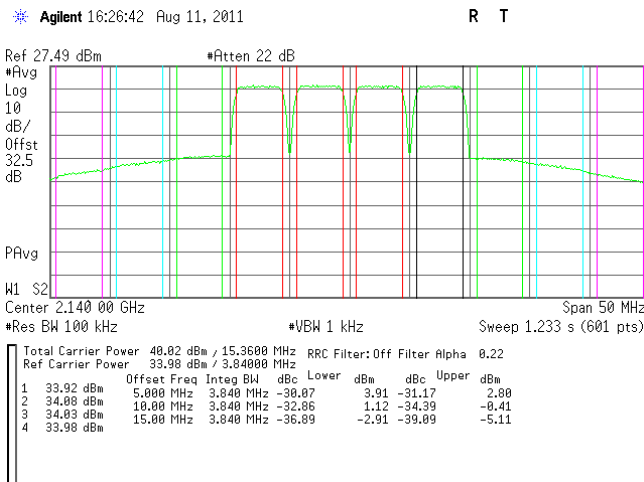

Post - DPD@2140MHz

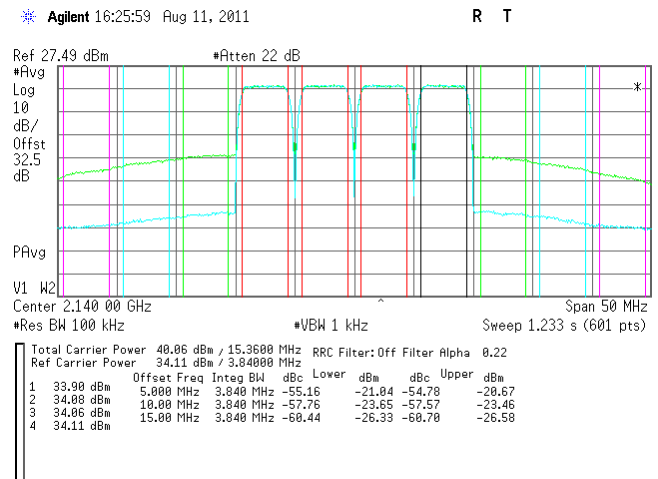

Pre - DPD@2160MHz

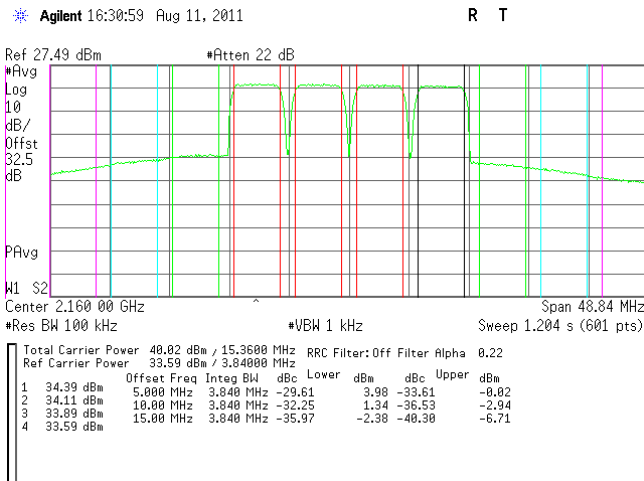

Post - DPD@2160MHz

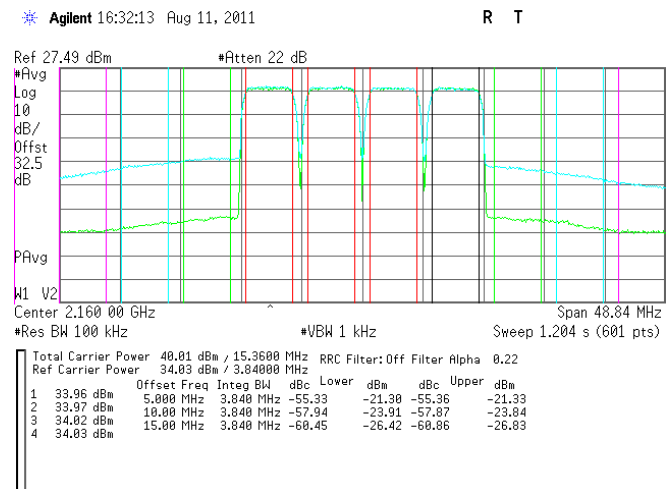

Test Results: DPD Operation (LTE 10MHz 1FA)

Pre - DPD@2120MHz

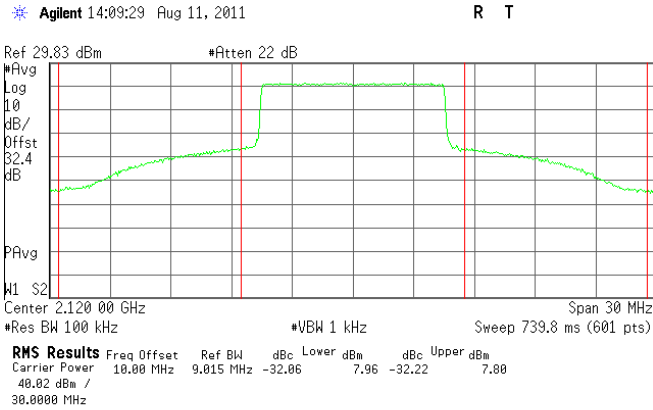

Post - DPD@2120MHz

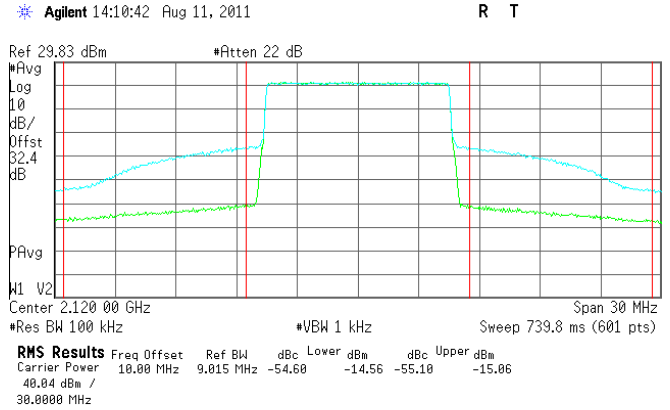

Pre - DPD@2140MHz

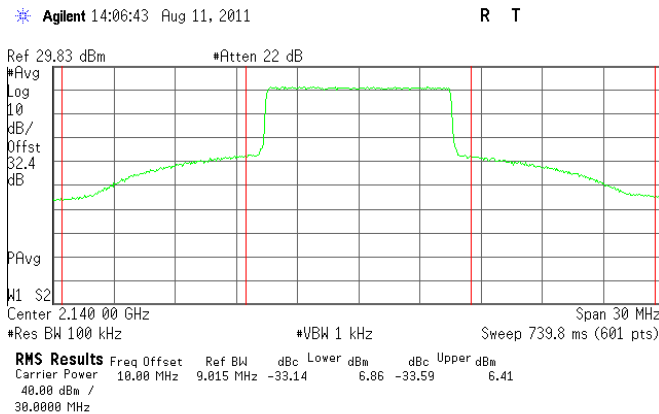

Post - DPD@2140MHz

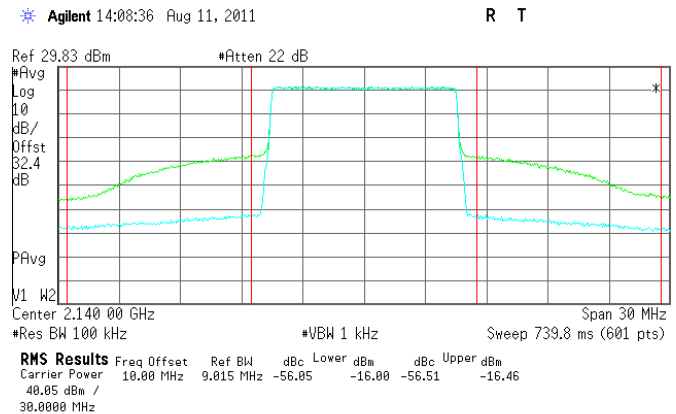

Pre - DPD@2160MHz

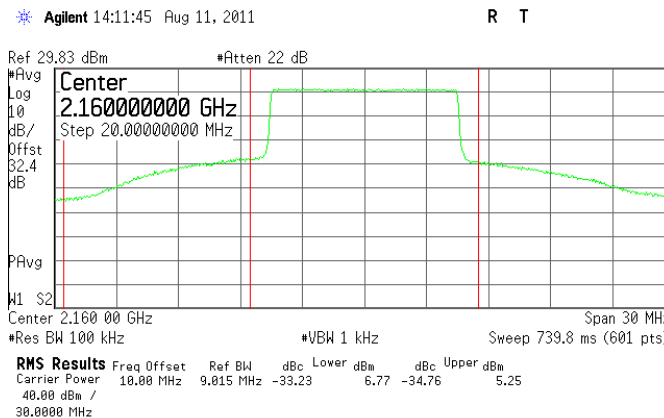

Post - DPD@2160MHz

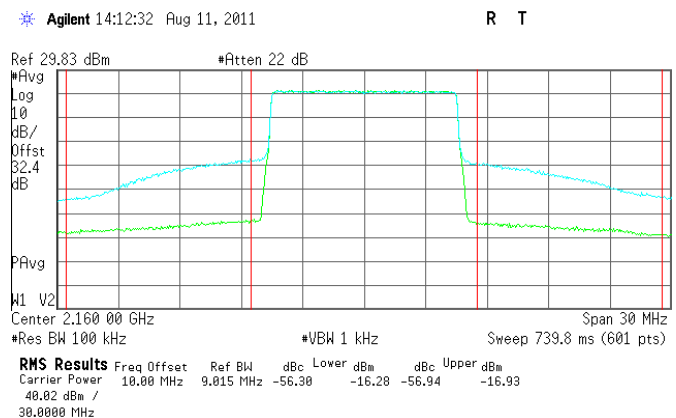

Test Sheet (S/N: RTP21-11090001)

S/N					
Gain		46.2dB			
Gain Flatness		1.0dB			
S11 (Max.)		-18.3dB			
S22 (Max.)		-21.9dB			
Feedback level@ 40dBm		2.5dBm			
Test Frequency (@Center)		2120MHz	2140 MHz	2160 MHz	
Psat (dBm)		48.5	48.5	48.2	
WCDMA 4FA @10W PAR:7.5dB	ACLR@±5MHz (dBc)	Pre-DPD	-28.5	-30.0	-29.6
		Post-DPD	-53.9	-54.8	-55.3
	ACLR@±10MHz (dBc)	Pre -DPD	-31.4	-32.8	-32.2
		Post-DPD	-56.1	-57.5	-57.8
	ACLR@±15MHz (dBc)	Pre -DPD	-35.5	-36.9	-35.9
		Post-DPD	-58.8	-60.4	-60.4
105mA/5.6V, Current/28V		860mA	865mA	871mA	
Efficiency		%	40.5	40.3	40.0

LTE 1FA PAR:7.5dB	ACLR@±10MHz (dBc)	Pre -DPD	-32.0	-33.1	-33.2
		Post-DPD	-54.6	-56.5	-56.3
105mA/5.6V, Current/28V		837mA	845mA	865mA	
Efficiency		%	41.6	41.2	40.3

RFHIC Corporation (RFHIC) reserves the right to make changes to any products herein or to discontinue any product at any time without notice. RFHIC do not assume any liability for the suitability of its products for any particular purpose, and disclaims any and all liability, including without limitation consequential or incidental damages. The product specifications herein expressed have been carefully checked and are assumed to be reliable. However, RFHIC disclaims liability for inaccuracies and strongly recommends buyers to verify that the information they are using is current before placing purchase orders. RFHIC products are not intended for use in life support equipment or application where malfunction of the product can be expected to result in personal injury or death. Buyer uses or sells such products for any such unintended or unauthorized application, buyer shall indemnify, protect and hold RFHIC and its directors, officers, stockholders, employees, representatives and distributors harmless against any and all claims arising out of such use. RFHIC's liability under or arising out of damages, claims of whatsoever kind and nature which RFHIC products could cause shall be limited in amount to the net purchase price of the products sold to buyer by RFHIC.