

Features

- 3.0x1.0x1.5mm right angle SMD LED
- Ideal for indication on hand held products
- Low current operation
- Standard Package: 2,000pcs/ Reel
- MSL (Moisture Sensitivity Level): 3
- Halogen-free
- RoHS compliant

Applications

- Backlighting for tell-tale indicators
- Dashboard lighting
- Interior lighting (footwell, dome light, accent lighting, etc.)
- Exterior lighting (turn signals, side markers, CHMSL, etc.)
- Signs and signals
- Various applications requiring high temperature rating



ATTENTION
OBSERVE PRECAUTIONS
FOR HANDLING
ELECTROSTATIC
DISCHARGE
SENSITIVE
DEVICES

Package Schematics

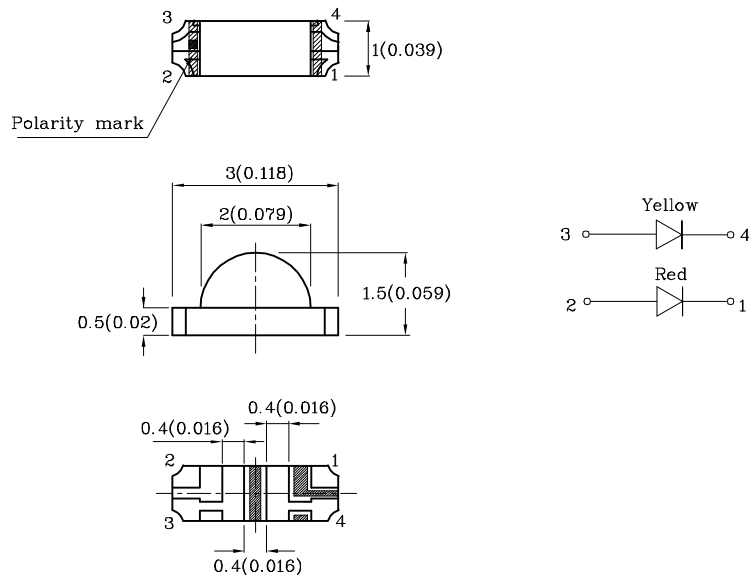

Notes:

1. All dimensions are in millimeters (inches).
2. Tolerance is $\pm 0.2(0.008)$ unless otherwise noted.
3. Specifications are subject to change without notice.

Part Number	Emitting Color	Emitting Material	Luminous Intensity CIE127-2007* (I _F =20mA) mcd			Lens-color	Viewing Angle 2θ 1/2
			Code.	min.	max.		
XZMDKMYKX56W-HTA	Red	AlGaInP	N	120	200	Water Clear	150°
			P	200	300		
			Q	300	400		
			H*	55*	80*		
			M*	80*	120*		
			N*	120*	200*		
	Yellow	AlGaInP	N	120	200		
			P	200	300		
			Q	300	400		
			N*	120*	200*		
			P*	200*	300*		
			Q*	300*	400*		

Note:
1.01/2 is the angle from optical centerline where the luminous intensity is 1/2 of the optical peak value.
*Luminous intensity value is in accordance with CIE127-2007 standards.

Absolute Maximum Ratings at Ta=25°C

Parameter	Symbol	Value		Unit
		Red	Yellow	
Power dissipation	PD	75	75	mW
Reverse Voltage	V _R	5	5	V
Junction temperature	T _J	115	115	°C
Operating Temperature	Top	-40 To +100		°C
Storage Temperature	T _{stg}	-40 To +115		°C
DC Forward Current	I _F	30	30	mA
Peak Forward Current [2]	I _{FM}	185	175	mA
Electrostatic Discharge Threshold (HBM)		3000	3000	V
Thermal Resistance (Junction/ambient) [1]	R _{th j-a}	500	710	°C/W
Thermal Resistance (Junction / Solder point) [1]	R _{th j-s}	400	600	°C/W

Notes:
1. R_{th(j-a)} Results from mounting on PC board FR4 (pad size ≥ 16 mm² per pad),
2. 1/10 Duty Cycle, 0.1ms Pulse Width.
3. A Relative Humidity between 40% and 60% is recommended in ESD-protected work areas to reduce static build up during assembly process
(Reference JEDEC/JESD625-A and JEDEC/J-STD-033)

Electrical / Optical Characteristics at Ta=25°C

Parameter	Symbol	Chip	Value				Unit
			Code.	Min.	Typ.	Max.	
Wavelength at peak emission CIE127-2007* IF = 20mA	λ_{peak}	Red Yellow	-	-	645* 590*	-	nm
Dominant Wavelength CIE127-2007* IF = 20mA	λ_{dom} [1]	Red	-	620*	-	640*	nm
		Yellow	3*	586*	-	588*	
			4*	588*	-	590*	
			5*	590*	-	592*	
		6*	592*	-	594*		
Spectral bandwidth at 50% $\Phi_{REL MAX}$ IF = 20mA	$\Delta\lambda$	Red Yellow	-	-	28 20	-	nm
Forward Voltage IF = 20mA	V _F [2]	Red Yellow	-	-	1.95 2.0	2.5 2.5	V
Reverse Current (V _R = 5V)	I _R	Red Yellow	-	-	-	10 10	μ A
Temperature coefficient of λ_{peak} IF = 20mA, -10°C ≤ T ≤ 100°C	TC λ_{peak}	Red Yellow	-	-	0.14 0.12	-	nm/°C
Temperature coefficient of λ_{dom} IF = 20mA, -10°C ≤ T ≤ 100°C	TC λ_{dom}	Red Yellow	-	-	0.05 0.07	-	nm/°C
Temperature coefficient of V _F IF = 20mA, -10°C ≤ T ≤ 100°C	TC _V	Red Yellow	-	-	-1.9 -1.9	-	mV/°C

Notes:

1. Wavelength : +/- 1nm.

2. Forward Voltage: +/-0.1V.

* Wavelength value is in accordance with CIE127-2007 standards.

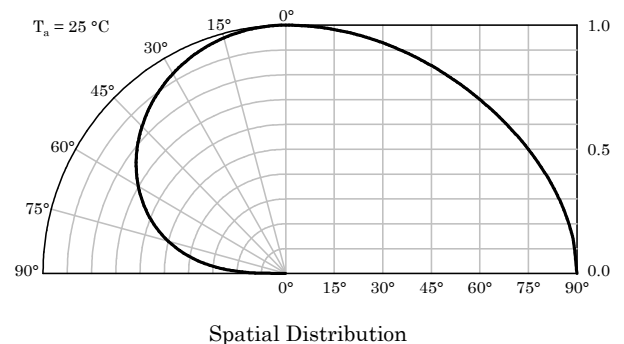
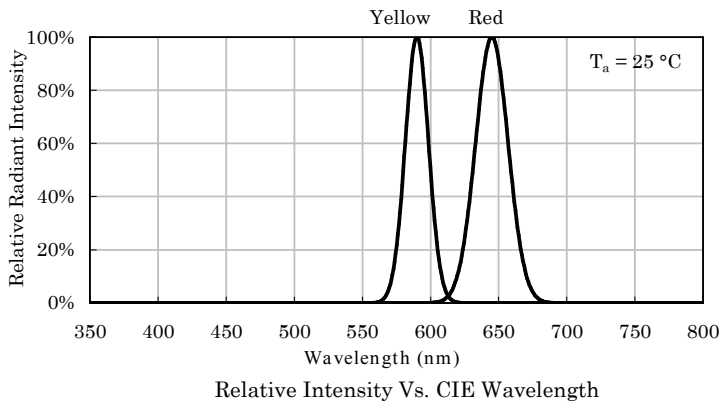

❖ Red

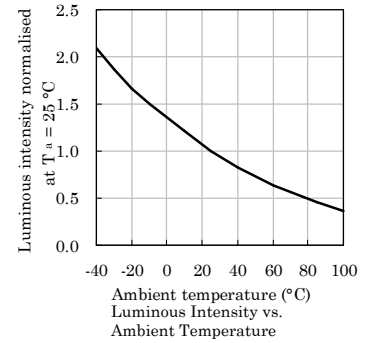
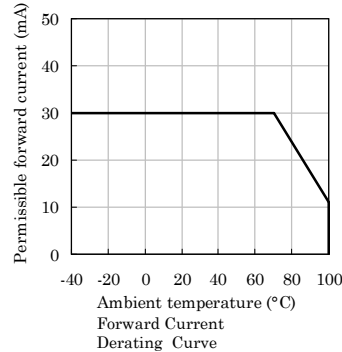
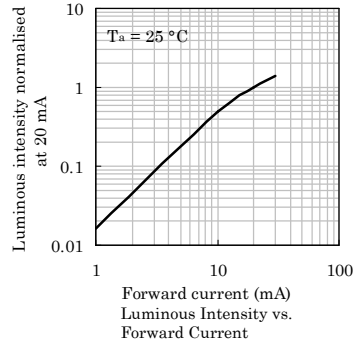
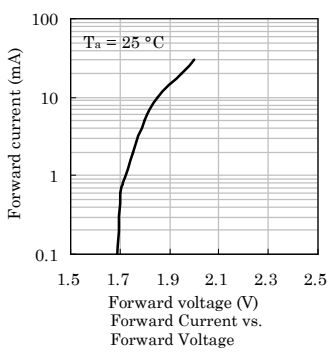

❖ Yellow

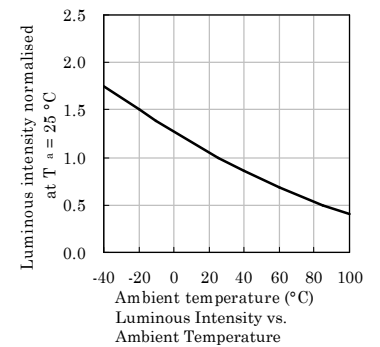
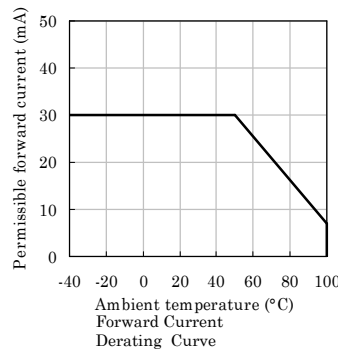
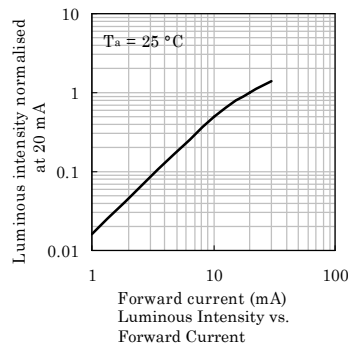
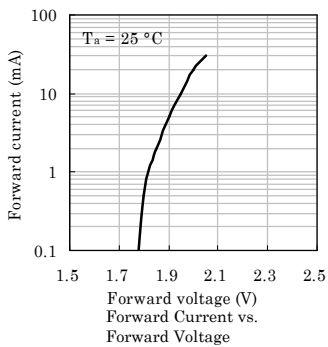

LED is recommended for reflow soldering and soldering profile is shown below.

Reflow Soldering Profile for SMD Products (Pb-Free Components)

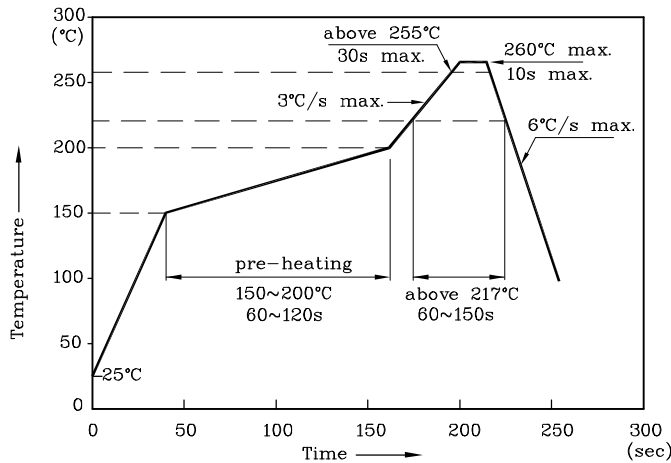

Notes:

1. All temperatures refer to the center of the package, measured on the package body surface facing up during reflow.
2. Do not apply any stress to the LED during high temperature conditions.
3. Maximum number of soldering passes: 2

❖ The device has a single mounting surface.
The device must be mounted according to the specifications.

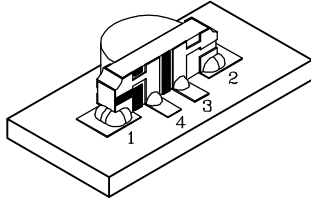

❖ Reel Dimension (Units : mm)

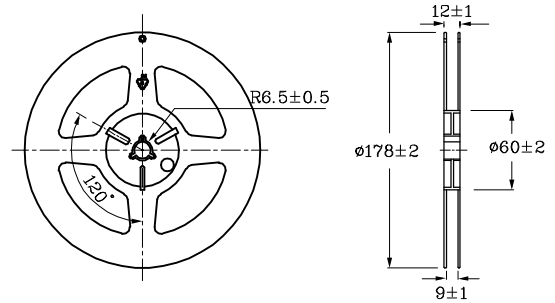

❖ Recommended Soldering Pattern (Units : mm; Tolerance: ± 0.1)

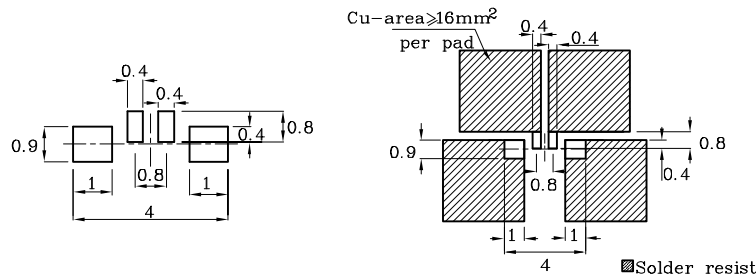

❖ Tape Specification (Units : mm)

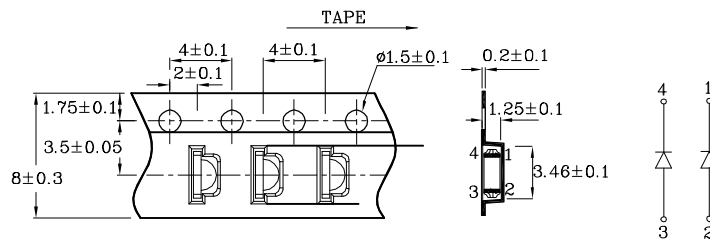

Remarks:

If special sorting is required (e.g. binning based on forward voltage, Luminous intensity / luminous flux, or wavelength), the typical accuracy of the sorting process is as follows:

1. Wavelength: +/-1nm
2. Luminous intensity / luminous flux: +/-15%
3. Forward Voltage: +/-0.1V

Note: Accuracy may depend on the sorting parameters.

PACKING & LABEL SPECIFICATIONS

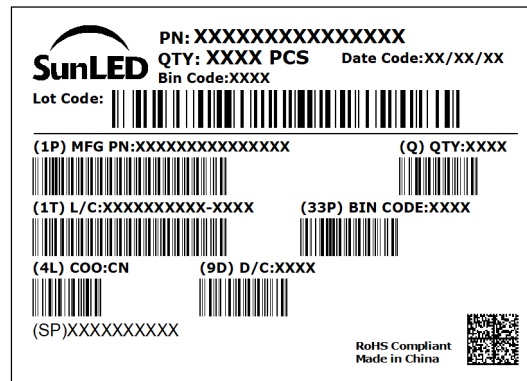
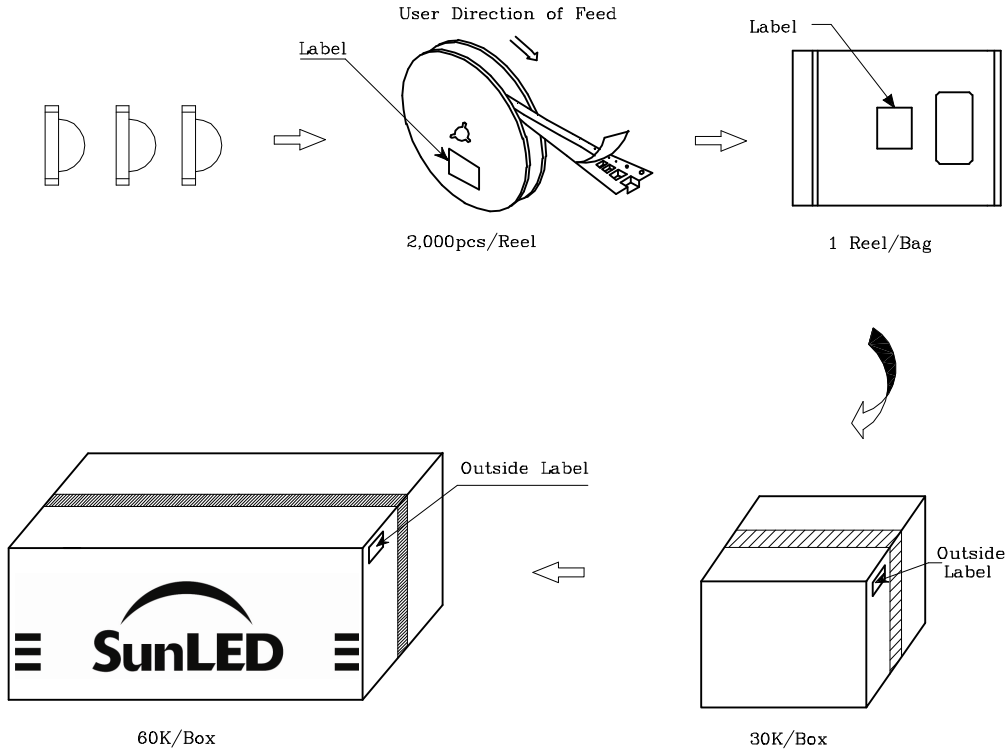

TERMS OF USE

1. Data presented in this document reflect statistical figures and should be treated as technical reference only.
2. Contents within this document are subject to improvement and enhancement changes without notice.
3. The product(s) in this document are designed to be operated within the electrical and environmental specifications indicated on the datasheet. User accepts full risk and responsibility when operating the product(s) beyond their intended specifications.
4. The product(s) described in this document are intended for electronic applications in which a person's life is not reliant upon the LED. Please consult with a SunLED representative for special applications where the LED may have a direct impact on a person's life.
5. The contents within this document may not be altered without prior consent by SunLED.
6. Additional technical notes are available at <https://www.SunLEDusa.com/TechnicalNotes.asp>

Reliability Test Items And Conditions

The reliability of products shall be satisfied with items listed below

Lot Tolerance Percent Defective (LTPD) : 10%

No.	Test Item	Standards	Test Condition	Test Times / Cycles	Number of Damaged
1	Continuous operating test	-	T _a = 25°C, I _F = maximum rated current *	1,000 h	0 / 22
2	High Temp. operating test	EIAJ ED-4701/100(101)	T _a = 100°C, I _F = maximum rated current *	1,000 h	0 / 22
3	Low Temp. operating test	-	T _a = -40°C, I _F = maximum rated current *	1,000 h	0 / 22
4	High temp. storage test	EIAJ ED-4701/100(201)	T _a = maximum rated storage temperature	1,000 h	0 / 22
5	Low temp. storage test	EIAJ ED-4701/100(202)	T _a = -40°C	1,000 h	0 / 22
6	High temp. & humidity storage test	EIAJ ED-4701/100(103)	T _a = 60°C, RH = 90%	1,000 h	0 / 22
7	High temp. & humidity operating test	EIAJ ED-4701/100(102)	T _a = 60°C, RH = 90% I _F = maximum rated current *	1,000 h	0 / 22
8	Soldering reliability test	EIAJ ED-4701/100(301)	Moisture soak: 30°C, 70% RH, 72h Preheat: 150~180°C (120s max.) Soldering temp: 260°C(10s)	2 times	0 / 18
9	Thermal shock operating test	-	T _a = -40°C(15min) ~ 100°C(15min) I _F = derated current at 100°C	1,000 cycles	0 / 22
10	Thermal shock test	-	T _a = -40°C(15min) ~ maximum rated Storage temperature(15min)	1,000 cycles	0 / 22
11	Electric Static Discharge (ESD)	EIAJ ED-4701/100(304)	C = 100pF , R2 = 1.5KΩ V = 3000V (Red) V=3000V (Yellow)	Once each Polarity	0 / 22
12	Vibration test	-	a = 196m/s ² , f = 100~2KHz , t = 48min for all xyz axes	4 times	0 / 22

* : Refer to forward current vs. derating curve diagram

Criteria for Judging Damage

Items	Symbols	Conditions	Failure Criteria
luminous Intensity	I _v	I _F = 20mA	Testing Min. Value <Spec.Min.Value x 0.5
Forward Voltage	V _F	I _F = 20mA	Testing Max. Value ≥Spec.Max.Value x 1.2
Reverse Current	I _R	V _R = Maximum Rated Reverse Voltage	Testing Max. Value ≥Spec.Max.Value x 2.5
High temp. storage test	-	-	Occurrence of notable decoloration, deformation and cracking