

THIS DRAWING IS UNPUBLISHED  
 RELEASED FOR PUBLICATION NOV, 2001.  
 ALL RIGHTS RESERVED.  
 © COPYRIGHT 2009 By -

LOC	DIST	REVISIONS			
P	LTR	DESCRIPTION	DATE	DWN	APVD
IR	-	E3	ECR-10-026537	27JUN11	KK HMR

- NOTE:
- 1 MATERIAL :  
HOUSING : NYLON 66 OR EQUIVALENT, UL94V-0, BLACK COLOUR.  
CONTACT : COPPER ALLOY
  - 2 FINISH:  
CONTACT : GOLD PLATED (SEE TABLE) ON CONTACT AREA  
80μ" MIN. TIN PLATED ON SOLDER TAIL,  
50μ" MIN. NICKEL UNDERPLATED ALL OVER.
3. APPLICATION :  
SOLDERTAIL LENGTH 2.6 FOR PCB THICKNESS 1.6±0.1  
1.2 FOR PCB THICKNESS 0.3 MAX.
  4. KEYING POS. : HOUSING CAVITY MOLDED SHUT
  5. QUALIFICATION TEST REPORT: 501-57197

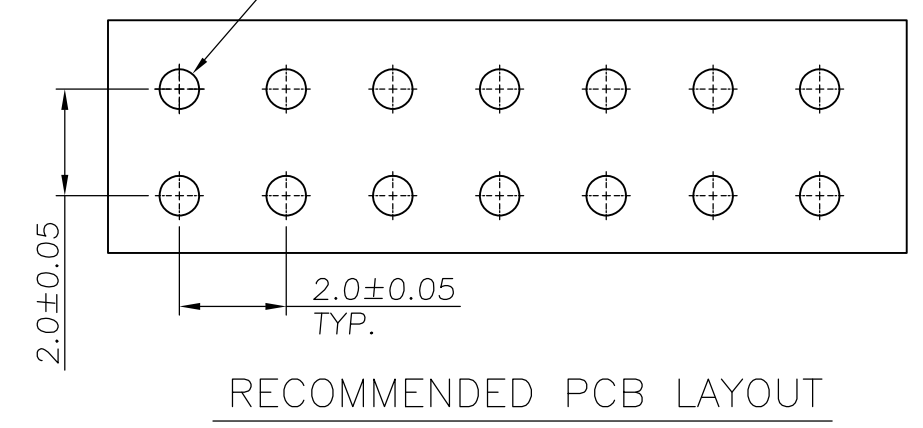
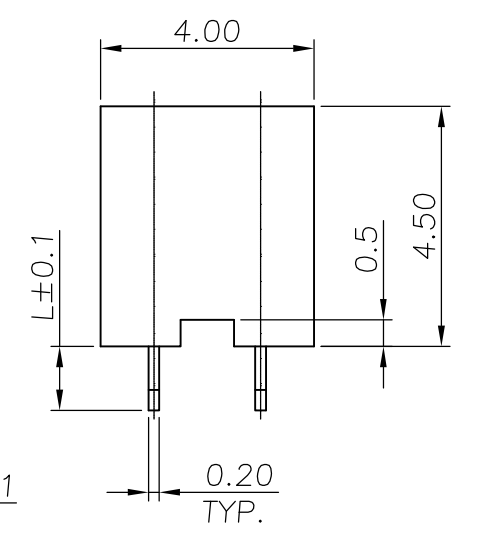
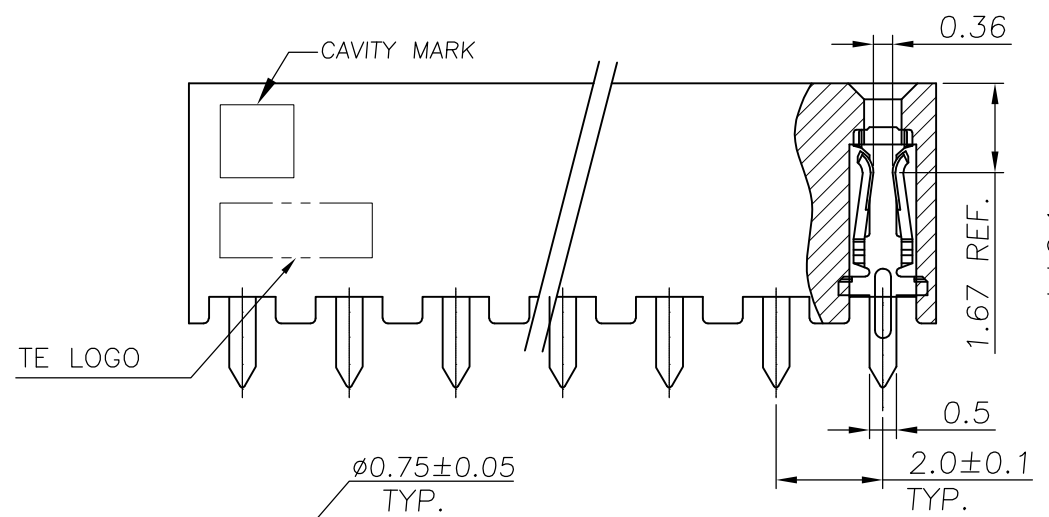
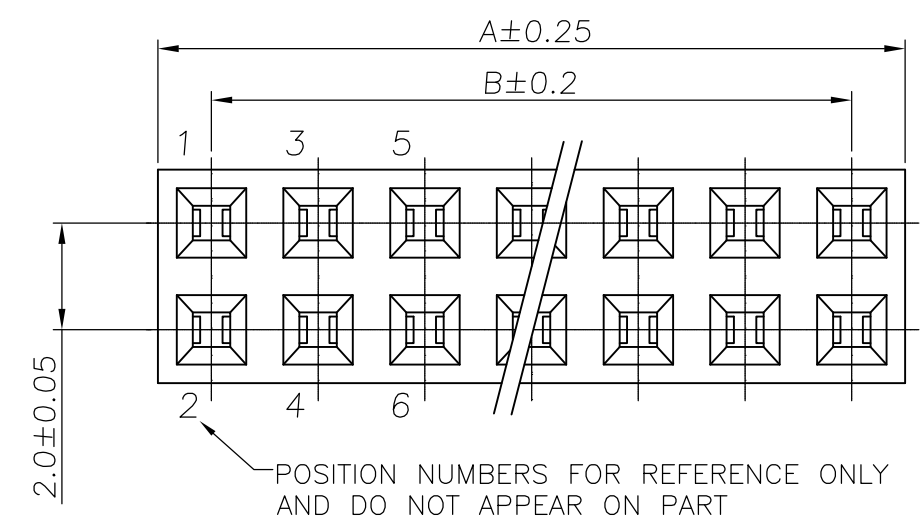
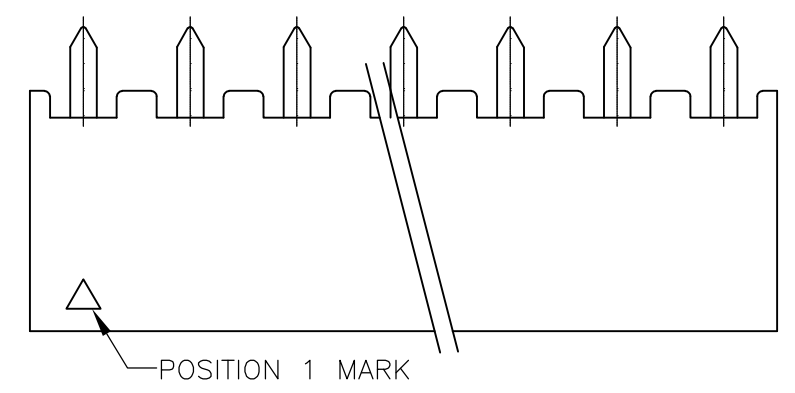

OBsolete	6	40	38	40	9	9	OBsolete	6	40	38	40	4	4	9
OBsolete		50	48	50	9	8			50	48	50	4	4	8
OBsolete		48	46	48	9	7			48	46	48	4	4	7
OBsolete		46	44	46	9	6			46	44	46	4	4	6
OBsolete		44	42	44	9	5			44	42	44	4	4	5
OBsolete		42	40	42	9	4			42	40	42	4	4	4
OBsolete		40	38	40	9	3			40	38	40	4	4	3
OBsolete		38	36	38	9	2			38	36	38	4	4	2
OBsolete		36	34	36	9	1			36	34	36	4	4	1
OBsolete		34	32	34	9	0			34	32	34	4	4	0
OBsolete		32	30	32	8	9			32	30	32	3	3	9
OBsolete		30	28	30	8	8			30	28	30	3	3	8
OBsolete		28	26	28	8	7			28	26	28	3	3	7
OBsolete		26	24	26	8	6			26	24	26	3	3	6
OBsolete		24	22	24	8	5			24	22	24	3	3	5
OBsolete		22	20	22	8	4			22	20	22	3	3	4
OBsolete		20	18	20	8	3			20	18	20	3	3	3
OBsolete		18	16	18	8	2			18	16	18	3	3	2
OBsolete		16	14	16	8	1			16	14	16	3	3	1
OBsolete		14	12	14	8	0			14	12	14	3	3	0
OBsolete		12	10	12	7	9			12	10	12	2	2	9
OBsolete		10	8	10	7	8			10	8	10	2	2	8
OBsolete		8	6	8	7	7			8	6	8	2	2	7
OBsolete		6	4	6	7	6			6	4	6	2	2	6
OBsolete		4	2	4	7	5			4	2	4	2	2	5
OBsolete		50	48	50	7	4			50	48	50	2	2	4
OBsolete		48	46	48	7	3			48	46	48	2	2	3
OBsolete		46	44	46	7	2			46	44	46	2	2	2
OBsolete		44	42	44	7	1			44	42	44	2	2	1
OBsolete		42	40	42	7	0			42	40	42	2	2	0
OBsolete		40	38	40	6	9			40	38	40	1	1	9
OBsolete		38	36	38	6	8			38	36	38	1	1	8
OBsolete		36	34	36	6	7			36	34	36	1	1	7
OBsolete		34	32	34	6	6			34	32	34	1	1	6
OBsolete		32	30	32	6	5			32	30	32	1	1	5
OBsolete		30	28	30	6	4			30	28	30	1	1	4
OBsolete		28	26	28	6	3			28	26	28	1	1	3
OBsolete		26	24	26	6	2			26	24	26	1	1	2
OBsolete		24	22	24	6	1			24	22	24	1	1	1
OBsolete		22	20	22	6	0			22	20	22	1	1	0
OBsolete		20	18	20	5	9			20	18	20			9
OBsolete		18	16	18	5	8			18	16	18			8
OBsolete		16	14	16	5	7			16	14	16			7
OBsolete		14	12	14	5	6			14	12	14			6
OBsolete		12	10	12	5	5			12	10	12			5
OBsolete		10	8	10	5	4			10	8	10			4
OBsolete		8	6	8	5	3			8	6	8			3
OBsolete		6	4	6	5	2			6	4	6			2
OBsolete		4	2	4	5	1			4	2	4			1

THIS DRAWING IS A CONTROLLED DOCUMENT.

DWN	O.HU	30-NOV-2001	 TE Connectivity	AMPMODU 2.0mm PITCH REC CONN,VERTICAL MOUNT TYPE							
CHK	J.CHENG	30-NOV-2001									
APVD	J.WU	30-NOV-2001									
PRODUCT SPEC	108-57197										
APPLICATION SPEC			SIZE	A3	CAGE CODE	-	DRAWING NO	C-1470209	RESTRICTED TO	-	
MATERIAL	1	FINISH	2	WEIGHT	-	SCALE	1:1	SHEET	1 OF 2	REV	E3

CUSTOMER DRAWING

THIS DRAWING IS UNPUBLISHED  
 © COPYRIGHT 2009 By -  
 ALL RIGHTS RESERVED.

RELEASED FOR PUBLICATION NOV ,2001.

LOC	DIST	REVISIONS			
P	LTR	DESCRIPTION	DATE	DWN	APVD
	-	SEE SHEET 1	-	-	-

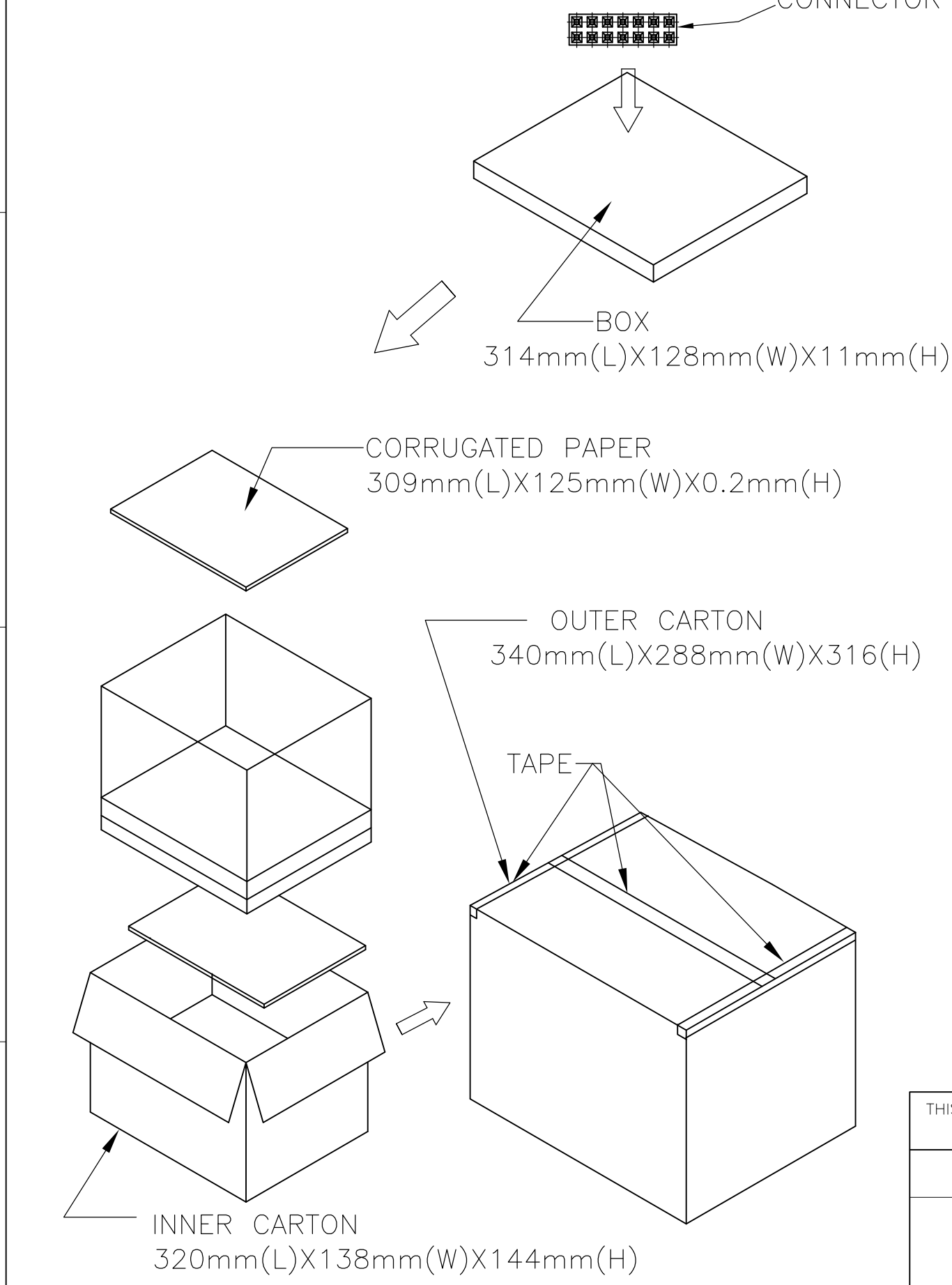

OBSOLETE	"L"	Pcs/Carton	Pcs/Inner Carton	Pcs/BOX	POS.	PART NUMBER	
	5040	1260	105	40	9	-9	
	4320	1080	90	50	9	-8	
OBSOLETE	4320	1080	90	48	9	-7	
OBSOLETE	4320	1080	90	46	9	-6	
OBSOLETE	4320	1080	90	44	9	-5	
OBSOLETE	5040	1260	105	42	9	-4	
	5040	1260	105	40	9	-3	
OBSOLETE	5040	1260	105	38	9	-2	
OBSOLETE	5760	1440	120	36	9	-1	
OBSOLETE	5760	1440	120	34	9	0	
OBSOLETE	6480	1620	135	32	8	-9	
	7200	1800	150	30	8	-8	
OBSOLETE	2.6±0.1	7200	1800	150	28	8	-7
OBSOLETE		7920	1980	165	26	8	-6
OBSOLETE		8640	2160	180	24	8	-5
OBSOLETE		9360	2340	195	22	8	-4
		10080	2520	210	20	8	-3
OBSOLETE		11520	2880	240	18	8	-2
OBSOLETE		12960	3240	270	16	8	-1
OBSOLETE		15120	3780	315	14	8	0
		17280	4320	360	12	7	-9
		20880	5220	435	10	7	-8
OBSOLETE		26640	6660	555	8	7	-7
		35280	8820	735	6	7	-6
OBSOLETE		51840	12960	1080	4	7	1470209-5
		4320	1080	90	50	7	-4
		4320	1080	90	48	7	-3
		4320	1080	90	46	7	-2
		4320	1080	90	44	7	-1
		5040	1260	105	42	7	0
		5040	1260	105	40	6	-9
		5040	1260	105	38	6	-8
		5760	1440	120	36	6	-7
		5760	1440	120	34	6	-6
		6480	1620	135	32	6	-5
		7200	1800	150	30	6	-4
		7200	1800	150	28	6	-3
		7920	1980	165	26	6	-2
		8640	2160	180	24	6	-1
		9360	2340	195	22	6	0
		10080	2520	210	20	5	-9
		11520	2880	240	18	5	-8
		12960	3240	270	16	5	-7
		15120	3780	315	14	5	-6
		17280	4320	360	12	5	-5
		20880	5220	435	10	5	-4
		26640	6660	555	8	5	-3
		35280	8820	735	6	5	-2
OBSOLETE		51840	12960	1080	4	5	1470209-1

OBSOLETE	"L"	Pcs/Carton	Pcs/Inner Carton	Pcs/BOX	POS.	PART NUMBER	
	5040	1260	105	40	4	-9	
	4320	1080	90	50	4	-8	
OBSOLETE	4320	1080	90	48	4	-7	
OBSOLETE	4320	1080	90	46	4	-6	
	4320	1080	90	44	4	-5	
OBSOLETE	5040	1260	105	42	4	-4	
	5040	1260	105	40	4	-3	
OBSOLETE	5040	1260	105	38	4	-2	
OBSOLETE	5760	1440	120	36	4	-1	
OBSOLETE	5760	1440	120	34	4	0	
OBSOLETE	6480	1620	135	32	3	-9	
	7200	1800	150	30	3	-8	
OBSOLETE	2.6±0.1	7200	1800	150	28	3	-7
OBSOLETE		7920	1980	165	26	3	-6
OBSOLETE		8640	2160	180	24	3	-5
OBSOLETE		9360	2340	195	22	3	-4
		10080	2520	210	20	3	-3
OBSOLETE		11520	2880	240	18	3	-2
OBSOLETE		12960	3240	270	16	3	-1
OBSOLETE		15120	3780	315	14	3	0
		17280	4320	360	12	2	-9
		20880	5220	435	10	2	-8
OBSOLETE		26640	6660	555	8	2	-7
		35280	8820	735	6	2	-6
OBSOLETE		51840	12960	1080	4	2	1470209-5
		4320	1080	90	50	2	-4
		4320	1080	90	48	2	-3
		4320	1080	90	46	2	-2
		4320	1080	90	44	2	-1
		5040	1260	105	42	2	0
		5040	1260	105	40	1	-9
		5040	1260	105	38	1	-8
		5760	1440	120	36	1	-7
		5760	1440	120	34	1	-6
		6480	1620	135	32	1	-5
		7200	1800	150	30	1	-4
		7200	1800	150	28	1	-3
		7920	1980	165	26	1	-2
		8640	2160	180	24	1	-1
		9360	2340	195	22	1	0
		10080	2520	210	20		-9
		11520	2880	240	18		-8
		12960	3240	270	16		-7
		15120	3780	315	14		-6
		17280	4320	360	12		-5
		20880	5220	435	10		-4
		26640	6660	555	8		-3
		35280	8820	735	6		-2
OBSOLETE		51840	12960	1080	4		1470209-1

THIS DRAWING IS A CONTROLLED DOCUMENT.		DWN	O.HU	30-NOV-2001	 TE Connectivity AMPMODU 2.0mm PITCH REC CONN,VERTICAL MOUNT TYPE
DIMENSIONS: mm		CHK	J.CHENG	30-NOV-2001	
TOLERANCES UNLESS OTHERWISE SPECIFIED:		APVD	J.WU	30-NOV-2001	
0 PLC ± - 1 PLC ± 0.15 2 PLC ± 0.10 3 PLC ± 0.05 4 PLC ± - ANGLES ± 3'		PRODUCT SPEC	108-57197		
MATERIAL	SEE SHEET 1	FINISH	SEE SHEET 1	APPLICATION SPEC	NAME
SEE SHEET 1		SEE SHEET 1		WEIGHT	-
CUSTOMER DRAWING				SIZE	A3
				CAGE CODE	-
				DRAWING NO	C-1470209
				RESTRICTED TO	-
				SCALE	1:1
				SHEET	2 OF 2
				REV	E3