

2 Way-0° 50Ω 24 to 30 GHz

The Big Deal

- Wide bandwidth, 24 to 30 GHz
- High isolation, 24 dB typ. at 27 GHz
- Low cost splitter for 5G Application



CASE STYLE: MC1630-1

Product Overview

Mini-Circuits' EP2-5G+ is a MMIC 2-way 0° splitter/combiner designed for wideband operation from 24 to 30 GHz supporting many applications requiring high performance across a wide frequency range including phased array radars, 5G applications, as well as instrumentation and more. This model provides excellent power handling up to 0.5W (as a splitter/combiner) with good isolation, and low phase and amplitude unbalance in a tiny 2 x 2 mm 6 lead-QFN package. Manufactured using GaAs IPD technology, the EP2-5G+ not only provides a repeatable performance, but also a high level of ESD protection.

Key Features

Feature	Advantages
Wideband, 24 to 30 GHz	Low cost power splitter designed for phased array radars and 5G applications.
High isolation, 24 dB typ. at 27 GHz Excellent power handling, 0.5W as a splitter / combiner	In power combiner applications, half the power is dissipated internally. EP2-5G+ is designed to handle 0.5W internal dissipation as a combiner allowing reliable operation without excessive temperature rise.
Excellent Amplitude unbalance, 0.1 dB typ. at 27 GHz Good phase unbalance, 4° typ. at 27 GHz	Ideal for Applications such as MIMO & phased array radars
Tiny size, 2X2mm QFN package	Tiny footprint saves space in dense layouts while providing low inductance, repeatable transitions, and excellent thermal contact to the PCB.

2 Way-0° 50Ω 24 to 30 GHz

Features

- Wide bandwidth, 24 to 30 GHz
- Excellent isolation, 24 dB typ. at 27 GHz
- Excellent amplitude unbalance, 0.1 dB typ. at 27 GHz
- Good phase unbalance, 4° at 27 GHz
- Small size, 2x2 mm
- Aqueous washable



Generic photo used for illustration purposes only

CASE STYLE: MC1630-1

+RoHS Compliant

The +Suffix identifies RoHS Compliance. See our web site for RoHS Compliance methodologies and qualifications

Applications

- 5G
- Phased array
- Instrumentation
- Radar
- Satellite communications

Electrical Specifications¹ at 25°C

Parameter	Frequency (GHz)	Min.	Typ.	Max.	Unit
Frequency Range		24		30	GHz
Insertion Loss above 3.0 dB	24 - 30	—	1.3	2.1	dB
Isolation	24 - 30	16	23	—	dB
Phase Unbalance	24 - 30	—	1.7	13	Degree
Amplitude Unbalance	24 - 30	—	0.1	0.7	dB
VSWR (Port S)	24 - 30	—	1.7	—	:1
VSWR (Port 1-2)	24 - 30	—	1.5	—	:1
Power Handling	As a splitter	24 - 30	—	0.5	W
	As a combiner	24 - 30	—	0.5	

1. Tested on Mini-Circuits Test Board TB-EP2-5GC+

Maximum Ratings

Parameter	Ratings
Operating Temperature	-55°C to 105°C
Storage Temperature	-65°C to 150°C

Permanent damage may occur if any of these limits are exceeded.

Pad Connections

Function	Pad Number
SUM PORT	5
PORT 1	1
PORT 2	3
GROUND	Paddle
NOT USED, GROUND EXTERNALLY	2,4,6

Simplified Electrical Schematic

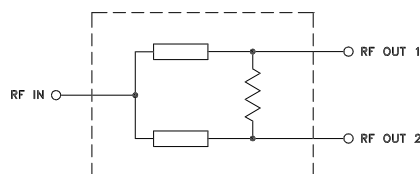

Additional Detailed Technical Information <i>additional information is available on our dash board. To access this information click here</i>	
Performance Data	Data Table
	Swept Graphs
	S-Parameter (S3P Files) Data Set (.zip file)
Case Style	MC1630-1 <i>Plastic package, exposed paddle; lead finish: Matte Tin</i>
Tape & Reel Standard quantities available on reel	F66 <i>7" reels with 20, 50, 100, 200, 500, 1000 & 2000 devices</i>
Suggested Layout for PCB Design	PL-667
Evaluation Board	TB-EP2-5G+ (without connectors) TB-EP2-5GC+ (with connectors)
Environmental Ratings	ENV82

ESD Rating

Human Body Model (HBM): Class 2 (Pass 2000V) in accordance with ANSI/ESD STM 5.1 - 2001

MSL Test Flow Chart

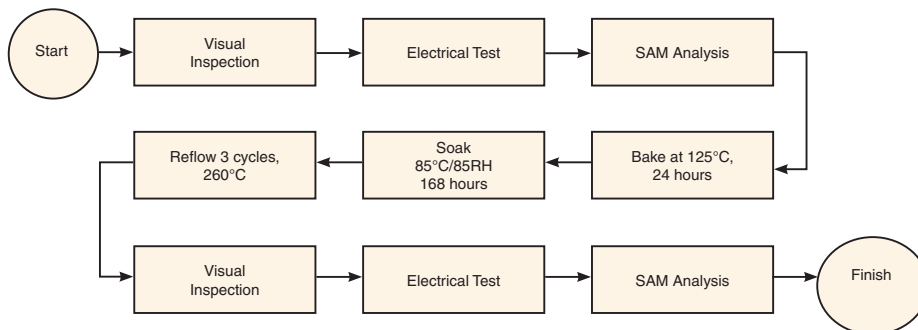

Additional Notes

- A. Performance and quality attributes and conditions not expressly stated in this specification document are intended to be excluded and do not form a part of this specification document.
- B. Electrical specifications and performance data contained in this specification document are based on Mini-Circuit's applicable established test performance criteria and measurement instructions.
- C. The parts covered by this specification document are subject to Mini-Circuits standard limited warranty and terms and conditions (collectively, "Standard Terms"); Purchasers of this part are entitled to the rights and benefits contained therein. For a full statement of the Standard Terms and the exclusive rights and remedies thereunder, please visit Mini-Circuits' website at www.minicircuits.com/MCLStore/terms.jsp

2 Way-0° Power Splitter/Combiner

EP2-5G+

Typical Performance Data

TEST CONDITIONS: Input Power = 0dBm @Temperature = +25°C

FREQ.	TOTAL LOSS ⁽¹⁾		AMP. UNBAL.	PHASE UNBAL.	ISOLATION	VSWR		
	(dB)	(dB)				(:1)		
(MHz)	S-1	S-2	(dB)	(deg.)	(dB)	S	1	2
15000	3.76	3.84	0.09	4.31	11.54	1.83	1.51	1.55
15500	3.97	4.05	0.08	4.62	11.94	2.05	1.61	1.66
16000	4.12	4.19	0.07	4.86	12.45	2.19	1.66	1.70
16500	4.16	4.21	0.05	5.09	13.01	2.19	1.64	1.66
17000	4.10	4.14	0.03	5.21	13.58	2.09	1.56	1.56
17500	3.98	4.00	0.02	5.30	14.13	1.93	1.47	1.45
18000	3.86	3.88	0.02	5.33	14.58	1.79	1.41	1.37
18500	3.80	3.84	0.04	5.40	14.94	1.72	1.39	1.35
19000	3.81	3.87	0.06	5.55	15.24	1.73	1.42	1.40
19500	3.91	3.99	0.08	5.87	15.56	1.80	1.49	1.50
20000	4.05	3.54	0.08	6.21	15.97	1.89	1.56	1.60
20500	4.19	3.67	0.07	6.57	16.43	1.98	1.62	1.65
21000	4.25	3.75	0.04	6.73	16.92	2.01	1.66	1.65
21500	4.26	3.79	0.02	6.82	17.37	2.01	1.68	1.60
22000	4.25	3.80	0.03	6.76	17.78	2.02	1.69	1.58
22500	4.26	3.79	0.05	6.86	18.16	2.03	1.69	1.61
23000	4.29	3.78	0.08	7.11	18.51	2.08	1.69	1.67
23500	4.35	3.77	0.10	7.42	18.86	2.13	1.69	1.73
24000	4.37	3.75	0.11	7.88	19.20	2.13	1.65	1.72
24500	4.33	3.72	0.09	8.22	19.57	2.07	1.60	1.65
25000	4.22	3.66	0.08	8.46	19.98	1.95	1.52	1.49
25500	4.12	3.57	0.07	8.59	20.50	1.82	1.45	1.39
26000	4.09	3.53	0.08	8.84	21.01	1.74	1.41	1.40
26500	4.12	3.52	0.10	9.00	21.44	1.72	1.40	1.51
27000	4.18	3.53	0.12	9.33	21.63	1.74	1.46	1.60
27500	4.22	3.56	0.12	9.75	21.50	1.79	1.51	1.65
28000	4.24	3.61	0.10	9.98	21.15	1.83	1.59	1.61
28500	4.22	3.63	0.07	10.20	20.76	1.84	1.61	1.56
29000	4.17	3.61	0.05	10.25	20.38	1.81	1.59	1.52
29500	4.09	3.50	0.03	10.31	20.14	1.73	1.54	1.50
30000	3.99	3.33	0.03	10.32	19.96	1.61	1.44	1.48
30500	3.88	3.18	0.04	10.34	19.81	1.47	1.35	1.42
31000	3.79	3.09	0.07	10.55	19.65	1.35	1.26	1.35
31500	3.76	3.07	0.08	10.78	19.44	1.25	1.19	1.24
32000	3.78	3.10	0.05	11.06	19.09	1.21	1.15	1.14
32500	3.85	3.15	0.02	11.05	18.60	1.22	1.15	1.09
33000	3.89	3.16	0.00	10.84	18.02	1.26	1.19	1.18
33500	3.91	3.16	0.03	10.57	17.42	1.28	1.26	1.31
34000	3.86	3.10	0.09	10.45	16.87	1.26	1.34	1.45
34500	3.81	3.04	0.17	10.45	16.39	1.18	1.41	1.56
35000	3.77	3.02	0.23	10.91	15.98	1.12	1.49	1.66

⁽¹⁾Total Loss = Insertion Loss + 3dB Splitter Loss



2 Way-0° Power Splitter/Combiner

EP2-5G+

Typical Performance Data

TEST CONDITIONS: Input Power = 0dBm @ Temperature = -55°C

FREQ. (MHz)	TOTAL LOSS ⁽¹⁾		AMP. UNBAL. (dB)	PHASE UNBAL. (deg.)	ISOLATION (dB)	VSWR (:1)		
	S-1	S-2				S	1	2
15000	3.37	3.50	0.13	3.82	11.07	1.87	1.53	1.57
15500	3.59	3.71	0.12	4.07	11.45	2.14	1.66	1.70
16000	3.75	3.86	0.12	4.28	11.96	2.31	1.72	1.77
16500	3.79	3.88	0.09	4.44	12.51	2.32	1.70	1.73
17000	3.71	3.79	0.08	4.51	13.09	2.19	1.61	1.62
17500	3.56	3.63	0.08	4.52	13.65	2.01	1.51	1.49
18000	3.41	3.49	0.08	4.53	14.09	1.85	1.43	1.38
18500	3.32	3.42	0.10	4.58	14.45	1.76	1.41	1.34
19000	3.32	3.45	0.13	4.73	14.72	1.76	1.44	1.39
19500	3.40	3.55	0.15	4.97	15.00	1.83	1.51	1.49
20000	3.54	3.69	0.16	5.29	15.35	1.94	1.58	1.60
20500	3.67	3.81	0.14	5.60	15.78	2.04	1.65	1.69
21000	3.75	3.87	0.12	5.73	16.24	2.11	1.72	1.73
21500	3.79	3.89	0.10	5.84	16.68	2.16	1.75	1.72
22000	3.80	3.90	0.10	5.83	17.09	2.19	1.77	1.71
22500	3.79	3.90	0.11	5.88	17.49	2.19	1.77	1.68
23000	3.78	3.90	0.13	6.02	17.87	2.20	1.76	1.69
23500	3.77	3.91	0.14	6.13	18.18	2.22	1.75	1.71
24000	3.75	3.90	0.15	6.34	18.52	2.20	1.70	1.71
24500	3.72	3.88	0.15	6.51	18.87	2.17	1.66	1.69
25000	3.66	3.82	0.16	6.72	19.26	2.09	1.58	1.60
25500	3.57	3.74	0.17	6.83	19.79	1.96	1.51	1.51
26000	3.53	3.70	0.17	7.11	20.19	1.88	1.46	1.44
26500	3.52	3.69	0.18	7.31	20.65	1.81	1.44	1.46
27000	3.53	3.71	0.18	7.51	20.90	1.80	1.49	1.52
27500	3.56	3.73	0.18	7.77	20.82	1.84	1.54	1.63
28000	3.61	3.78	0.17	7.89	20.52	1.93	1.63	1.71
28500	3.63	3.80	0.17	7.93	20.15	1.99	1.68	1.77
29000	3.61	3.78	0.17	8.11	19.75	2.00	1.69	1.77
29500	3.50	3.66	0.16	8.30	19.45	1.91	1.64	1.69
30000	3.33	3.49	0.16	8.47	19.21	1.72	1.52	1.55
30500	3.18	3.33	0.15	8.68	19.08	1.53	1.40	1.40
31000	3.09	3.23	0.14	8.79	18.97	1.38	1.29	1.28
31500	3.07	3.19	0.12	8.87	18.91	1.28	1.21	1.18
32000	3.10	3.21	0.11	8.90	18.63	1.25	1.16	1.14
32500	3.15	3.25	0.10	8.80	18.17	1.27	1.16	1.17
33000	3.16	3.28	0.12	8.67	17.56	1.32	1.20	1.25
33500	3.16	3.31	0.15	8.73	16.94	1.33	1.28	1.33
34000	3.10	3.30	0.20	8.80	16.28	1.31	1.35	1.43
34500	3.04	3.28	0.25	9.04	15.76	1.22	1.42	1.51
35000	3.02	3.28	0.27	9.38	15.33	1.14	1.50	1.60

⁽¹⁾Total Loss = Insertion Loss + 3dB Splitter Loss



2 Way-0° Power Splitter/Combiner

EP2-5G+

Typical Performance Data

TEST CONDITIONS: Input Power = 0dBm @ Temperature = +105°C

FREQ.	TOTAL LOSS ⁽¹⁾		AMP. UNBAL.	PHASE UNBAL.	ISOLATION	VSWR		
	(dB)	(dB)				(:1)		
(MHz)	S-1	S-2	(dB)	(deg.)	(dB)	S	1	2
15000	3.96	4.09	0.12	2.67	11.84	1.82	1.49	1.56
15500	4.17	4.27	0.10	2.96	12.27	2.01	1.58	1.65
16000	4.31	4.38	0.07	3.02	12.78	2.11	1.62	1.66
16500	4.34	4.38	0.05	3.00	13.33	2.09	1.60	1.59
17000	4.27	4.32	0.05	2.95	13.89	1.99	1.53	1.49
17500	4.17	4.23	0.06	2.96	14.41	1.87	1.46	1.42
18000	4.10	4.17	0.07	3.01	14.84	1.77	1.41	1.39
18500	4.09	4.16	0.08	3.06	15.17	1.74	1.41	1.39
19000	4.13	4.21	0.09	3.08	15.50	1.76	1.44	1.43
19500	4.23	4.33	0.10	3.13	15.88	1.82	1.50	1.48
20000	4.33	4.46	0.13	3.31	16.38	1.88	1.55	1.54
20500	4.42	4.55	0.13	3.60	16.94	1.92	1.58	1.59
21000	4.46	4.58	0.12	3.80	17.50	1.92	1.60	1.61
21500	4.47	4.56	0.09	3.94	17.97	1.91	1.60	1.58
22000	4.46	4.53	0.07	3.90	18.29	1.91	1.62	1.56
22500	4.49	4.57	0.08	3.79	18.54	1.94	1.65	1.55
23000	4.55	4.67	0.12	3.85	18.80	2.01	1.67	1.60
23500	4.64	4.80	0.15	4.00	19.11	2.08	1.69	1.67
24000	4.69	4.87	0.18	4.42	19.48	2.12	1.66	1.70
24500	4.66	4.83	0.17	4.79	19.92	2.06	1.60	1.68
25000	4.54	4.68	0.15	5.03	20.38	1.93	1.50	1.54
25500	4.40	4.53	0.13	5.09	20.97	1.77	1.41	1.39
26000	4.34	4.47	0.13	5.26	21.58	1.66	1.35	1.32
26500	4.36	4.51	0.16	5.35	22.08	1.61	1.34	1.39
27000	4.42	4.61	0.18	5.65	22.26	1.63	1.40	1.49
27500	4.50	4.68	0.19	6.10	22.05	1.70	1.47	1.59
28000	4.56	4.73	0.17	6.35	21.56	1.78	1.55	1.62
28500	4.55	4.69	0.13	6.50	21.06	1.81	1.59	1.60
29000	4.51	4.62	0.11	6.56	20.57	1.78	1.58	1.54
29500	4.42	4.51	0.09	6.54	20.30	1.69	1.52	1.48
30000	4.31	4.40	0.09	6.48	20.14	1.56	1.42	1.42
30500	4.21	4.32	0.11	6.47	20.05	1.41	1.33	1.37
31000	4.12	4.27	0.14	6.61	19.96	1.29	1.24	1.31
31500	4.10	4.25	0.14	6.85	19.79	1.20	1.18	1.22
32000	4.15	4.27	0.12	7.07	19.40	1.17	1.13	1.12
32500	4.22	4.30	0.08	6.99	18.85	1.19	1.14	1.06
33000	4.27	4.35	0.07	6.67	18.20	1.25	1.19	1.19
33500	4.30	4.40	0.11	6.35	17.60	1.27	1.27	1.33
34000	4.23	4.43	0.20	6.19	16.97	1.25	1.34	1.49
34500	4.17	4.45	0.29	6.43	16.50	1.16	1.42	1.60
35000	4.16	4.49	0.33	6.94	16.13	1.14	1.49	1.68

⁽¹⁾ Total Loss = Insertion Loss + 3dB Splitter Loss



Typical Performance Curves

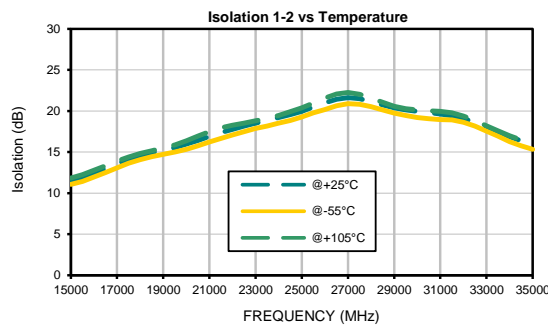
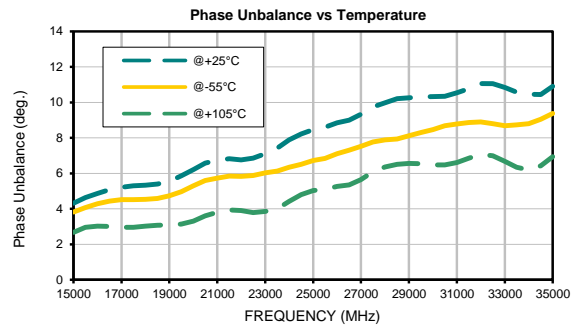
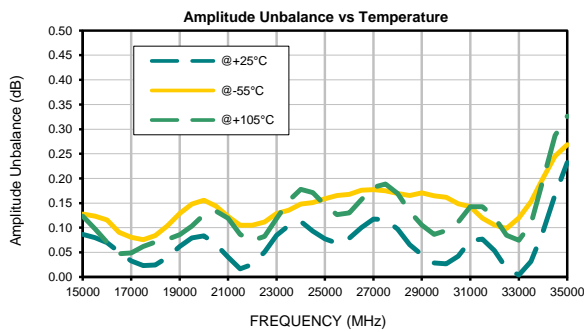
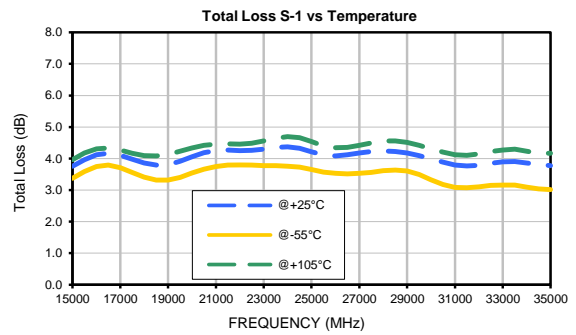
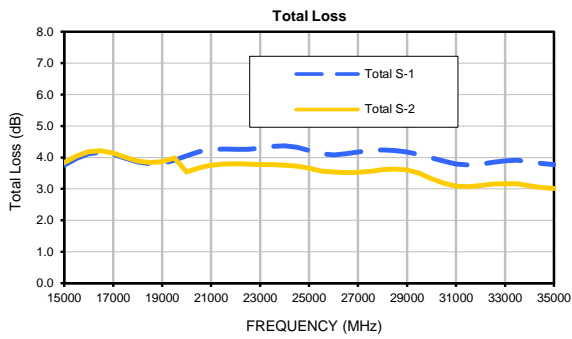

Typical Performance Curves

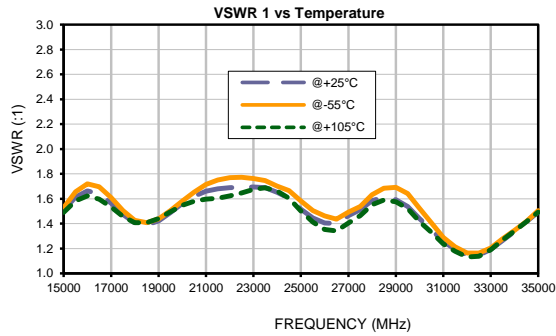
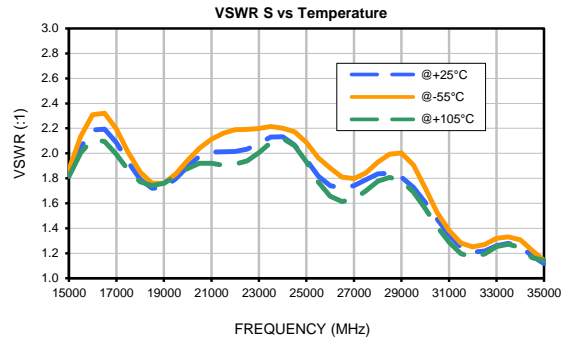
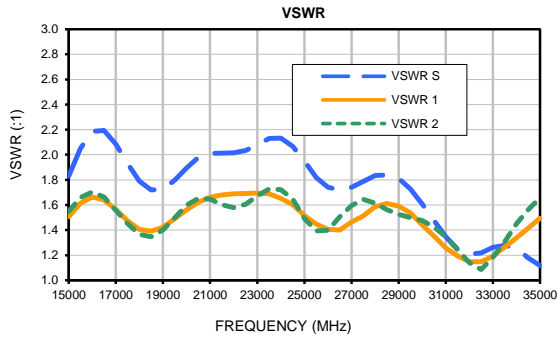

Outline Dimensions

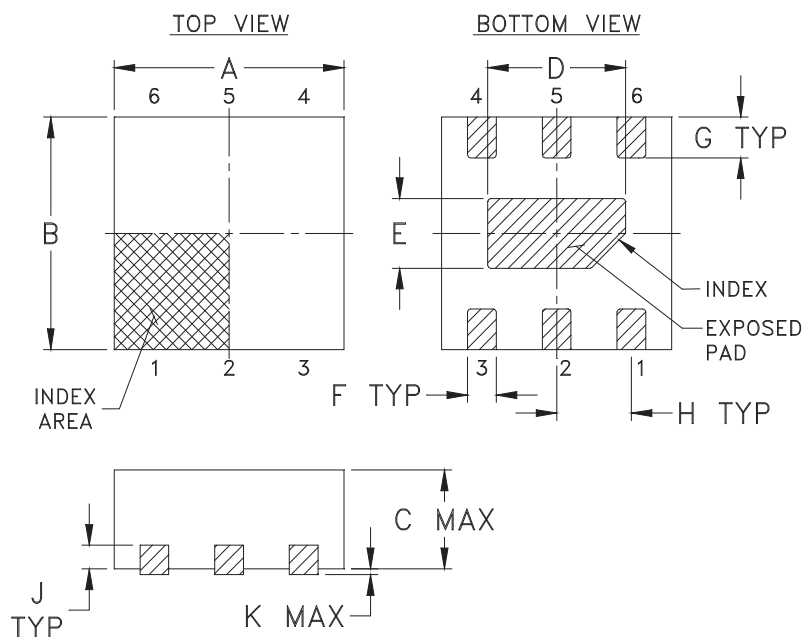

PCB Land Pattern

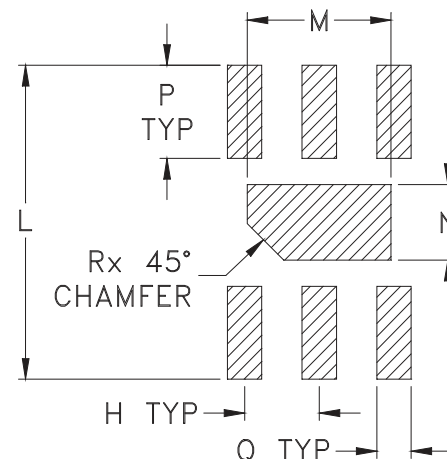

Suggested Layout,
Tolerance to be within $\pm .002$

CASE #.	A	B	C	D	E	F	G	H	J	K	L	M	N	P
MC1630-1	.079 (2.00)	.079 (2.00)	.039 (1.00)	.047 (1.20)	.024 (.60)	.010 (.25)	.014 (.35)	.026 (.65)	.008 (.20)	.002 (.05)	.106 (2.70)	.049 (1.25)	.026 (.65)	.031 (.80)

CASE #.	Q	R	WT, GRAM
MC1630-1	.012 (.30)	.012 (.30)	.006

Dimensions are in inches (mm). Tolerances: 2 Pl. $\pm .01$; 3 Pl. $\pm .005$

Notes:

- Case material: Plastic.
- Termination finish:
For RoHS Case Styles: Tin-Silver over Nickel plated or Matte-Tin plated (See Data sheet).
All models, (+) suffix.
- Lead #1 identifier shall be located in the cross-hatched area shown.
Identifier may be either a molded or marked feature.



P.O. Box 350166, Brooklyn, New York 11235-0003 (718) 934-4500 Fax (718) 332-4661 For detailed performance specs & shopping online see Mini-Circuits web site



The Design Engineers Search Engine Provides ACTUAL Data Instantly From MINI-CIRCUITS At: www.minicircuits.com

RF/IF MICROWAVE COMPONENTS

Tape & Reel Packaging TR-F66

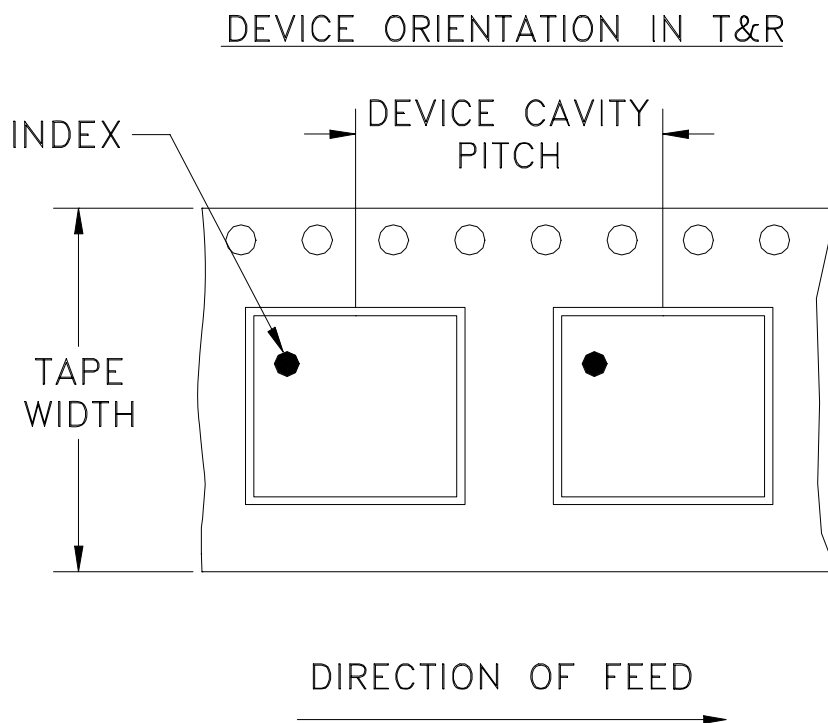

Tape Width, mm	Device Cavity Pitch, mm	Reel Size, inches	Devices per Reel see note	
8	4	7	Small quantity standard	20
				50
				100
				200
				500
		7	Standard	1000, 2000

Note: Please consult individual model data sheet to determine device per reel availability.

Mini-Circuits carrier tape materials provide protection from ESD (Electro-Static Discharge) during handling and transportation. Tapes are static dissipative and comply with industry standards EIA-481/EIA-541.

Go to: www.minicircuits.com/pages/pdfs/tape.pdf



INTERNET <http://www.minicircuits.com>

P.O. Box 350166, Brooklyn, New York 11235-0003 (718) 934-4500 Fax (718) 332-4661

Distribution Centers NORTH AMERICA 800-654-7949 • 417-335-5935 • Fax 417-335-5945 • EUROPE 44-1252-832600 • Fax 44-1252-837010

Mini-Circuits ISO 9001 & ISO 14001 Certified

THIRD ANGLE PROJECTION

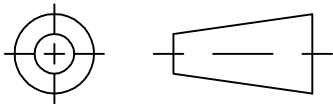

REVISIONS

REV	ECN No.	DESCRIPTION	DATE	DR	AUTH
OR	ECO-001451	NEW RELEASE	01/17/20	ITG	IL

SUGGESTED MOUNTING CONFIGURATION
FOR MC1630-1 CASE STYLE

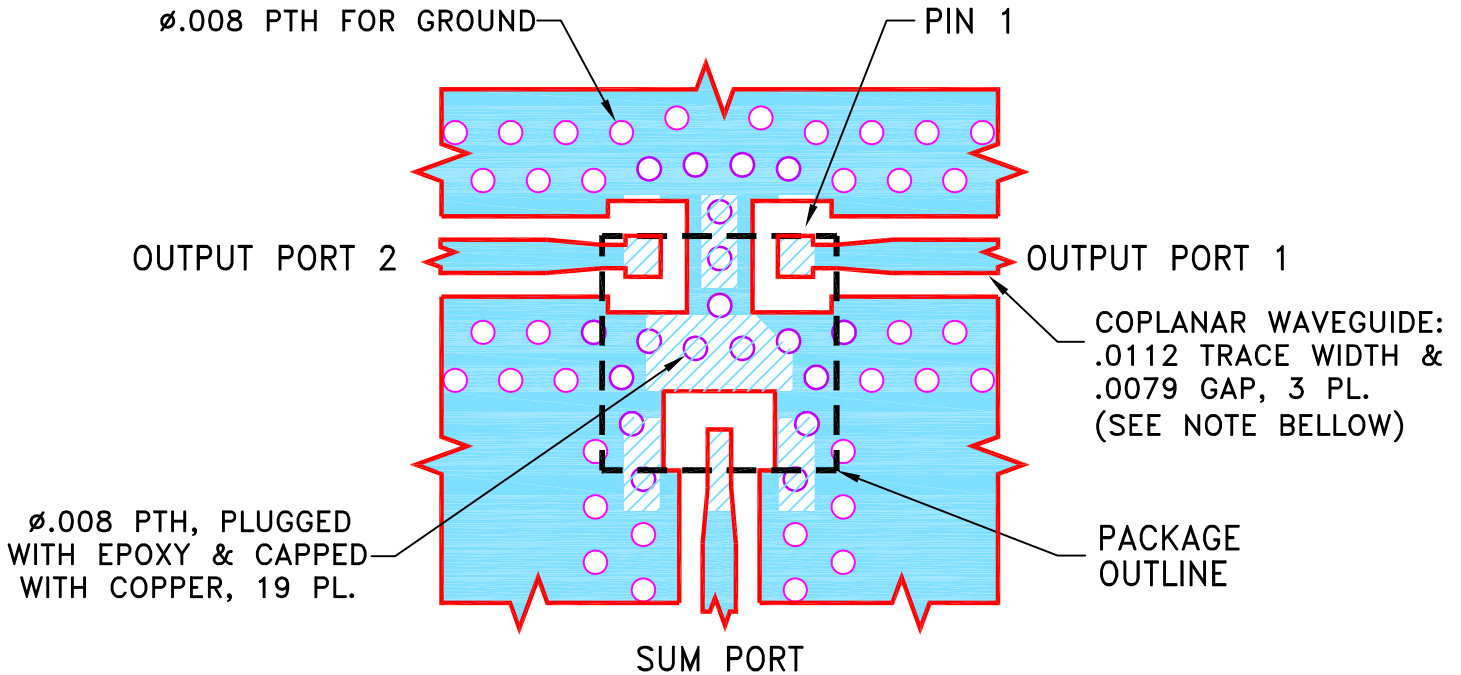

NOTES:

1. TRACE WIDTH & GAP ARE SHOWN FOR ROGERS RO4350B WITH DIELECTRIC THICKNESS $.0066 \pm .0007$ ". COPPER: 1/2 OZ. EACH SIDE. FOR OTHER MATERIALS TRACE WIDTH & GAP MAY NEED TO BE MODIFIED.
2. UNIT FOOT PRINT IS OPTIMIZED FOR PERFORMANCE AND IS DIFFERENT FROM CASE STYLE MC1630-1 RECOMMENDATIONS.
3. BOTTOM SIDE OF THE PCB IS CONTINUOUS GROUND PLANE.

- DENOTES PCB COPPER LAYOUT WITH SMOBC (SOLDER MASK OVER BARE COPPER).
- DENOTES COPPER LAND PATTERN FREE OF SOLDER MASK.

UNLESS OTHERWISE SPECIFIED	INITIALS	DATE
DIMENSIONS ARE IN INCHES TOLERANCES ON: 2 PL DECIMALS \pm 3 PL DECIMALS $\pm .005$ ANGLES \pm FRACTIONS \pm	DRAWN	ITG 01/17/20
	CHECKED	GF 01/17/20
	APPROVED	IL 01/17/20

Mini-Circuits[®] 13 Neptune Avenue
Brooklyn NY 11235

PL, MC1630-1, TB-EP2-5GC+

SIZE A	CODE IDENT 15542	DRAWING NO: 98-PL-667	REV: OR
FILE:	98PL667	SCALE: 15:1	SHEET: 1 OF 1

Mini-Circuits[®]
THIS DOCUMENT AND ITS CONTENTS ARE THE PROPERTY OF MINI-CIRCUITS. EXCEPT FOR USE EXPRESSLY GRANTED, IN WRITING, TO ITS VENDORS, VENDEE AND THE UNITED STATES GOVERNMENT, MINI-CIRCUITS RESERVES ALL PROPRIETARY DESIGN, USE, MANUFACTURING AND REPRODUCTION RIGHTS THERETO. THESE CONTENTS SHALL NOT BE USED, DUPLICATED OR DISCLOSED TO ANY OUTSIDE PARTY, IN WHOLE OR IN PART, WITHOUT WRITTEN PERMISSION OF MINI-CIRCUITS.

Evaluation Board and Circuit

SEE DETAIL "A"

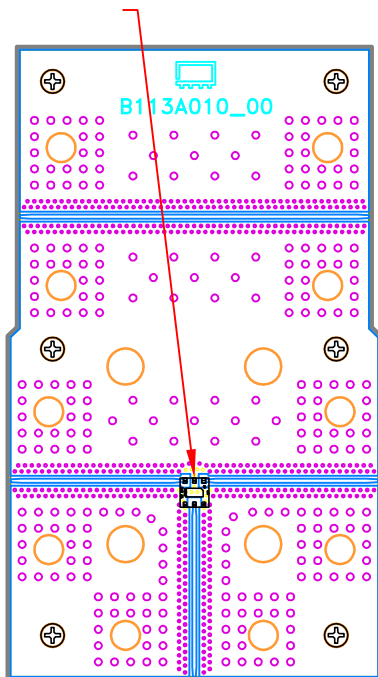

DUT INDEX

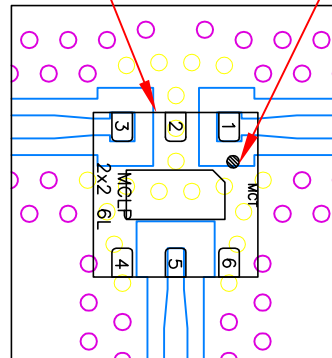

DETAIL "A"
(SCALE 5:1)

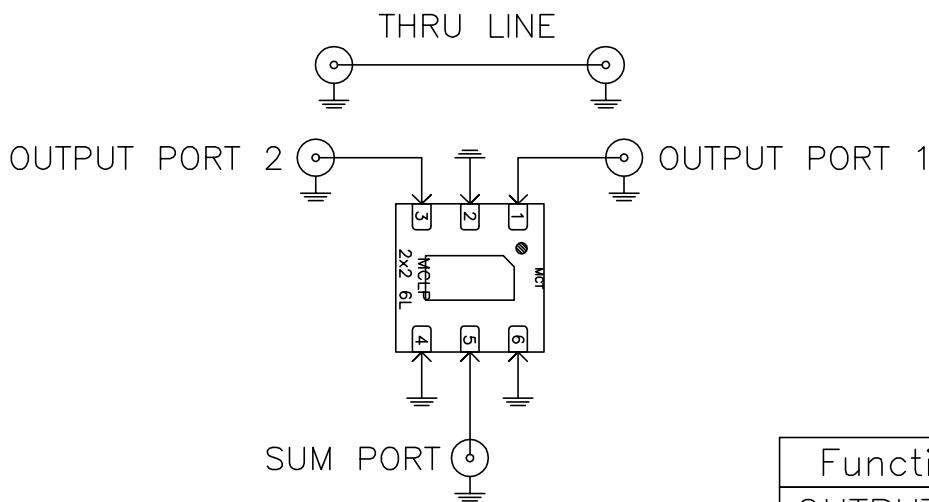

SCHEMATIC DIAGRAM

Function	Pad
OUTPUT PORT 1	1
OUTPUT PORT 2	3
SUM PORT	5
GND	2,4,6

Notes:

1. PCB Material: Roger R04350B or equivalent,
Dielectric constant=3.5, Thickness=0.0066 inch

 **Mini-Circuits®**

Evaluation Board and Circuit

SEE DETAIL "A"

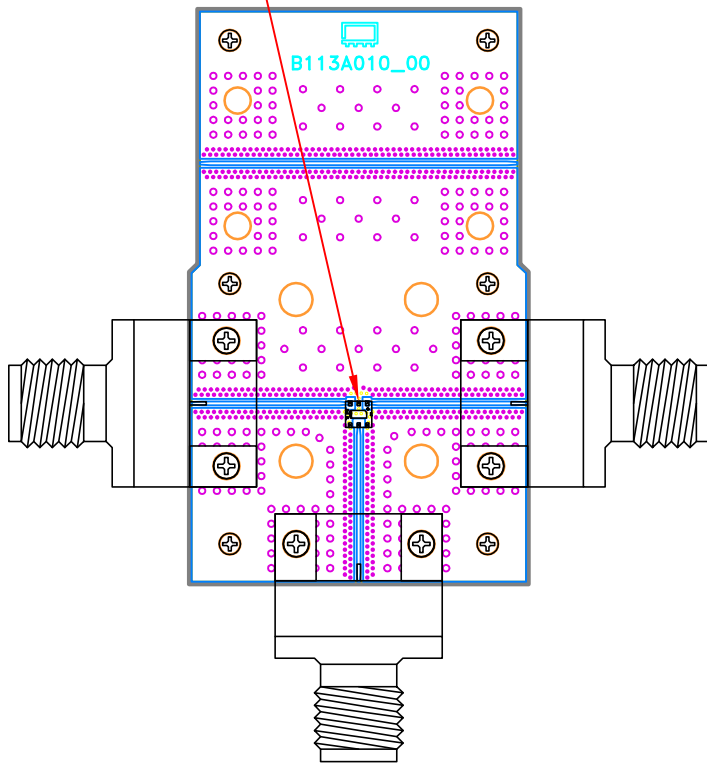

DUT INDEX

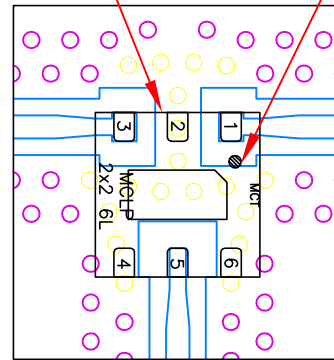

DETAIL "A"
(SCALE 5:1)

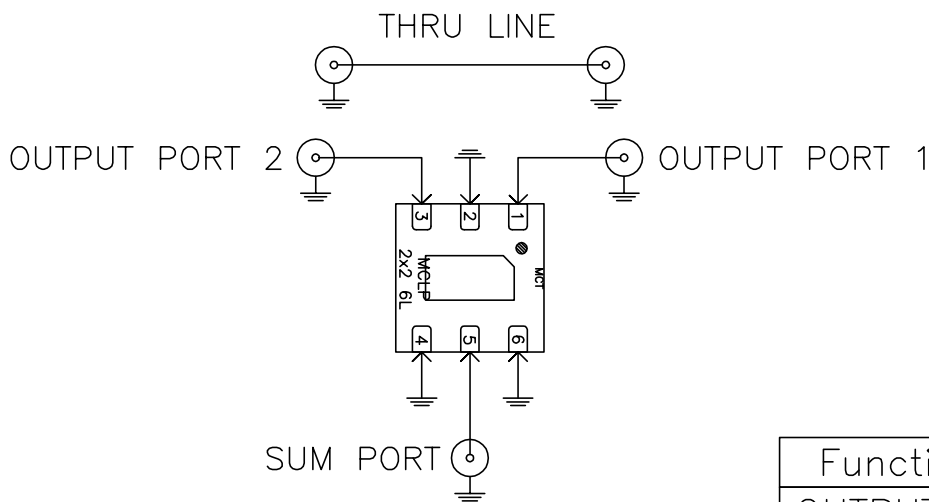

SCHEMATIC DIAGRAM

Function	Pad
OUTPUT PORT 1	1
OUTPUT PORT 2	3
SUM PORT	5
GND	2,4,6

Notes:

1. 2.4mm Female Connectors.
2. PCB Material: Roger R04350B or equivalent,
Dielectric constant=3.5, Thickness=0.0066 inch

 **Mini-Circuits®**



All Mini-Circuits products are manufactured under exacting quality assurance and control standards, and are capable of meeting published specifications after being subjected to any or all of the following physical and environmental test.

Specification	Test/Inspection Condition	Reference/Spec
Operating Temperature	-55° to 105°C Ambient Environment	Individual Model Data Sheet
Storage Temperature	-65° to 150° C Ambient Environment	Individual Model Data Sheet
Autoclave	15 psig, 100% RH, 121°C, 96 hours	JESD22-A102-C, Condition C
Temperature Cycling	-65° to 150°C, 100 cycles	JESD22-A104
Temperature Humidity	85°C/ 85% RH, 168 hours	JESD22-113
Solder Reflow Heat	Sn-Pb Eutetic Process: 240°C peak Pb-Free Process: 260°C peak	J-STD-020, Table 4-1, 4-2 and 5-2; Figure 5-1
Moisture Sensitivity: Level 1	Bake at 125°C for 24 hours Soak at 85°C/85% RH for 168 hours, Reflow 3 cycles at 240°C peak (Non-RoHS) or 260°C (RoHS)	J-STD-020C
Solderability	10X magnification, 95% coverage	JESD22-B102, Method 1: Dip and Look Test
Marking Resistance to Solvents	Isopropyl alcohol + mineral spirits at 25°C; terpene defluxer at 25°C; distilled water + proylene glycol monomethyl ether + monoethanolamine at 63°C to 70°C	MIL-STD-202, Method 215