

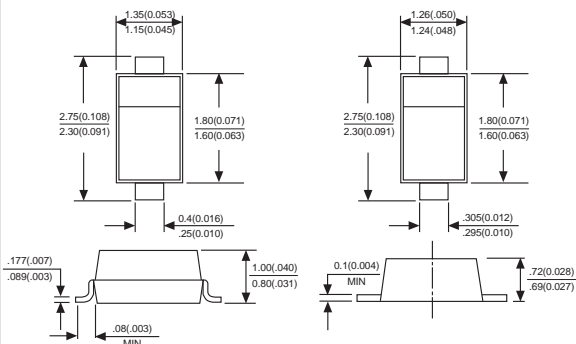

BZT52C2V4S-BZT52C39S

ZENER DIODE

SOD-323



Dimensions in millimeters and (inches)

Maximum ratings ($T_{amb}=25^{\circ}\text{C}$ unless otherwise specified)

FEATURES

- ▶ Planar die construction
- ▶ Ultra-Small surface mount package
- ▶ Ideally suited for automated assembly processes

MECHANICAL DATA

Case: Molded plastic body

Terminals: Plated leads solderable per MIL-STD-750, Method 2026

Polarity: Polarity symbols marked on case

PARAMETER	SYMBOLS	Limits	UNITS
Forward voltage (Note 2) @ $I_F=10\text{mA}$	V_F	0.9	V
Power dissipation (Note1)	P_d	200	mW
Thermal resistance, Junction to ambient air (Note1)	$R_{\theta JA}$	625	$^{\circ}\text{C}/\text{W}$
Operating and storage temperature range	T_J, T_{STG}	-65 to +150	$^{\circ}\text{C}$

NOTES: 1.Valid provided that device terminals are kept at ambient temperature.

2.Short duration test pulse used in minimize self-heating effect.

3.f=1KHz.

ELECTRICAL CHARACTERISTICS (@ TA=25°C unless otherwise specified)

Type Number	Type Code	Zener Voltage Range (Note 2)				Maximum Zener Impedance (Note 3)			Maximum Reverse Current (Note 2)		Temperature Coefficient of zener voltage @I _{ZT} =5mA	
		V _Z @I _{ZT}			I _{ZT}	Z _{ZT} @I _{ZT}	Z _{ZT} @I _{ZK}	I _{ZK}	I _R	V _R	mV / °C	
		Nom(V)	Min(V)	Max(V)	mA	Ω	Ω	mA	μA	V	Min	Max
BZT52C2V4S	WX	2.4	2.2	2.6	5	100	600	1.0	50	1.0	-3.5	0
BZT52C2V7S	W1	2.7	2.5	2.9	5	100	600	1.0	20	1.0	-3.5	0
BZT52C3V0S	W2	3.0	2.8	3.2	5	95	600	1.0	10	1.0	-3.5	0
BZT52C3V3S	W3	3.3	3.1	3.5	5	95	600	1.0	5	1.0	-3.5	0
BZT52C3V6S	W4	3.6	3.4	3.8	5	90	600	1.0	5	1.0	-3.5	0
BZT52C3V9S	W5	3.9	3.7	4.1	5	90	600	1.0	3	1.0	-3.5	0
BZT52C4V3S	W6	4.3	4.0	4.6	5	90	600	1.0	3	1.0	-3.5	0
BZT52C4V7S	W7	4.7	4.4	5.0	5	80	500	1.0	3	2.0	-3.5	0.2
BZT52C5V1S	W8	5.1	4.8	5.4	5	60	480	1.0	2	2.0	-2.7	1.2
BZT52C5V6S	W9	5.6	5.2	6.0	5	40	400	1.0	1	2.0	-2.0	2.5
BZT52C6V2S	WA	6.2	5.8	6.6	5	10	150	1.0	3	4.0	0.4	3.7
BZT52C6V8S	WB	6.8	6.4	7.2	5	15	80	1.0	2	4.0	1.2	4.5
BZT52C7V5S	WC	7.5	7.0	7.9	5	15	80	1.0	1	5.0	2.5	5.3
BZT52C8V2S	WD	8.2	7.7	8.7	5	15	80	1.0	0.7	5.0	3.2	6.2
BZT52C9V1S	WE	9.1	8.5	9.6	5	15	100	1.0	0.5	6.0	3.8	7.0
BZT52C10S	WF	10	9.4	10.6	5	20	150	1.0	0.2	7.0	4.5	8.0
BZT52C11S	WG	11	10.4	11.6	5	20	150	1.0	0.1	8.0	5.4	9.0
BZT52C12S	WH	12	11.4	12.7	5	25	150	1.0	0.1	8.0	6.0	10.0
BZT52C13S	WI	13	12.4	14.1	5	30	170	1.0	0.1	8.0	7.0	11.0
BZT52C15S	WJ	15	13.8	15.6	5	30	200	1.0	0.1	10.5	9.2	13.0
BZT52C16S	WK	16	15.3	17.1	5	40	200	1.0	0.1	11.2	10.4	14.0
BZT52C18S	WL	18	16.8	19.1	5	45	225	1.0	0.1	12.6	12.4	16.0
BZT52C20S	WM	20	18.8	21.2	5	55	225	1.0	0.1	14.0	14.4	18.0
BZT52C22S	WN	22	20.8	23.3	5	55	250	1.0	0.1	15.4	16.4	20.0
BZT52C24S	WO	24	22.8	25.6	5	70	250	1.0	0.1	16.8	18.4	22.0
BZT52C27S	WP	27	25.1	28.9	2	80	300	0.5	0.1	18.9	21.4	25.3
BZT52C30S	WQ	30	28.0	32.0	2	80	300	0.5	0.1	21.0	24.4	29.4
BZT52C33S	WR	33	31.0	35.0	2	80	325	0.5	0.1	23.1	27.4	33.4
BZT52C36S	WS	36	34.0	38.0	2	90	350	0.5	0.1	25.2	30.4	37.4
BZT52C39S	WT	39	37.0	41.0	2	130	350	0.5	0.1	27.3	33.4	41.2

Note:

1. Valid provided device terminals are kept at ambient temperature
2. Test with pluses, period=5ms, pluse width=300us.
3. f=1KHz

MDD ELECTRONIC

RATINGS AND CHARACTERISTIC CURVES BZT52C2V4S-BZT52C39S

FIG. 1- POWER DERATING CURVE

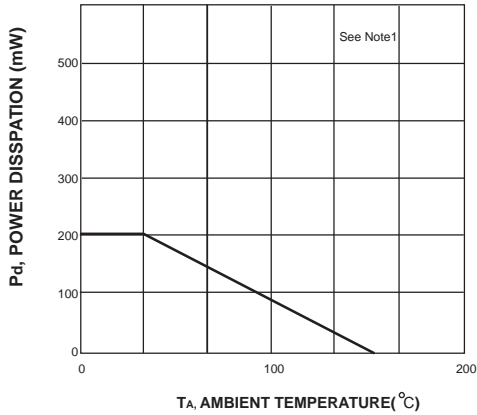

FIG. 2-ZENER BREAKDOWN CHARACTERISTICS

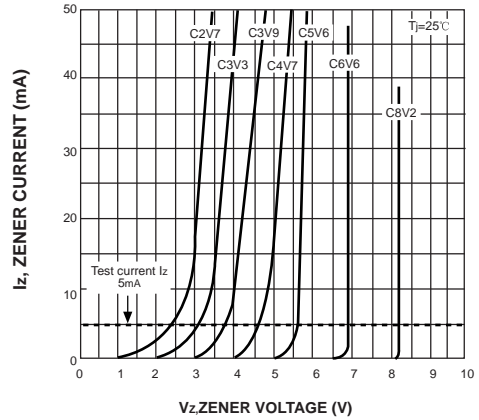

FIG. 3-ZENER BREAKDOWN CHARACTERISTICS

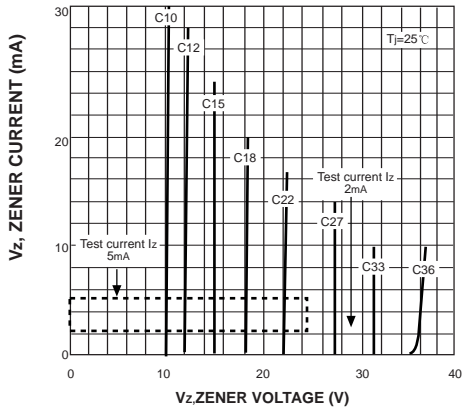
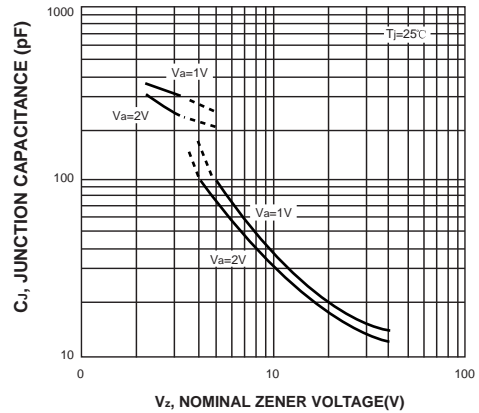

FIG. 4-JUNCTION CAPACITANCE VS NOMINAL ZENER VOLTAGE



RATINGS AND CHARACTERISTIC CURVES BZT52C2V4S-BZT52C39S

PACKAGE OUTLINE

Plastic surface mounted package

SOD-323

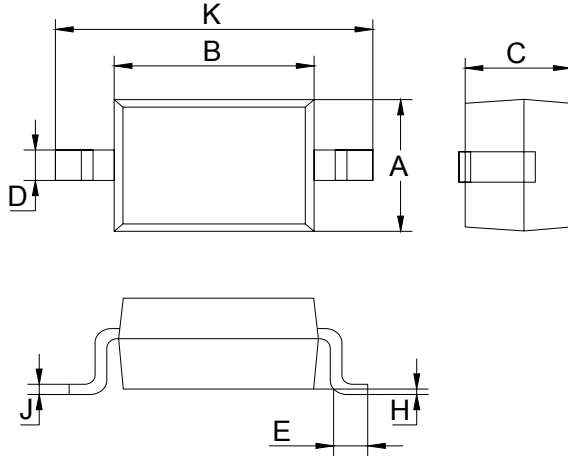

SOD-323		
Dim	Min	Max
A	1.275	1.325
B	1.675	1.725
C	0.9 Typical	
D	0.25	0.35
E	0.27	0.37
H	0.02	0.1
J	0.1 Typical	
K	2.6	2.7
All Dimensions in mm		

SOLDERING FOOTPRINT

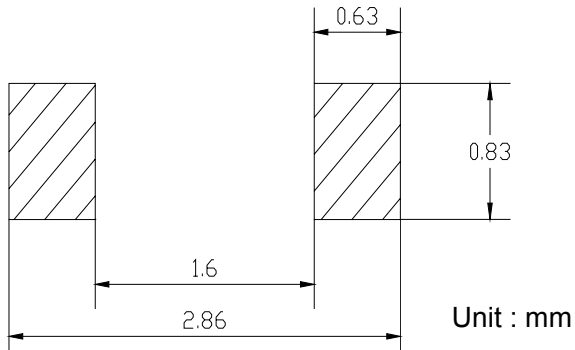

PACKAGE INFORMATION

Device	Package	Shipping
BZT52C2V0S-BZT52C39S	SOD-323	3000/Tape&Reel