

DC-DC Power Supplies

VDN 60 SERIES (60 WATTS DC-DC CAR and FLIGHT ADAPTER)

Features

Input plug for car cigarette receptacle and new with aircraft plug
 (Order suffix: VDN60....F)
 Wide range DC input 10.7-28VDC
 Interchangeable DC output cable* for different application
 Adjustable output voltage & current
 Constant current output built-in
 Fully enclosed plastic case
 Fully regulated output
 High efficiency; High Quality



Electrical specifications

Input

Voltage 10.7-28VDC (wide range)
 Current 6.5Arms Max. @12VDC I/P
 Fuse 8A

Output

Voltage (Vo) (see table)
 Tolerance 5%
 Power (Po) 60W Max.
 Voltage adjust range 15-24VDC
 Current limit range (Io) ... 2.1-4.2A (adjustable)
 Overcurrent protection ... Constant current type
 Short circuit protection ... Built-in
 Over temp protection Built-in
 Efficiency 85% typ. at full load and 12VDC I/P
 Ripple/Noise(Vp-p) 1% Max. (20MHz bandwidth)

Output Electronic Specifications

Model No.	Po	Vo	Io max
VDN60-1500	60W	15V	4.0A
VDN60-1600	60W	16V	3.75A
VDN60-1800	60W	18V	3.35A
VDN60-1900	60W	19V	3.16A
VDN60-2000	60W	20V	3.0A
VDN60-2200	60W	22V	2.73A
VDN60-2400	60W	24V	2.5A

*Output cable please refer to output cable diagram.

Environmental

Operating temperature

0 deg. C to +40 deg. C ambient

Storage temperature

-20 deg. C to +80 deg. C ambient

EMI

Meet CISPR 22
 Air discharge 15kV
 Contact discharge 3kV

Safety

UL: UL 2089
 CE: EN 60950
 E1: (E13 Luxembourg) **E13**

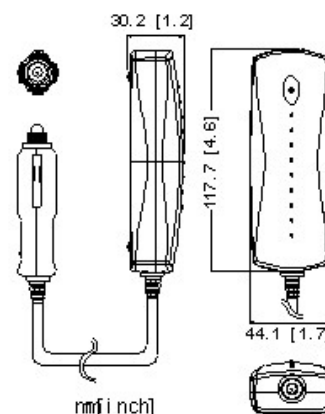

Power Systems – The Power Solution

Web: www.Power-Systems.de
 Email: Info@Power-Systems.de

Address: Dörnet 8 ; 74360 Ilsfeld-Auenstein / Germany
 Tel. : + 49 / 70 62 / 67 59 - 6
 Fax: + 49 / 70 62 / 67 59 - 80

DC-DC Power Supplies

VDN 60 SERIES (60 WATTS DC-DC CAR and FLIGHT ADAPTER)

Cable Series:

C101



Plug Spec:

ID :1.5mm
OD :3.5mm
Length :6.2mm
With clip
Right angle

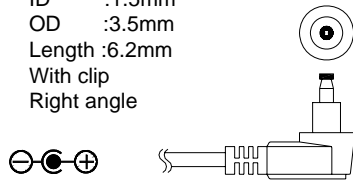

C106



Plug Spec:

INSIDE :Vout (+)
OUTSIDE :GND (-)

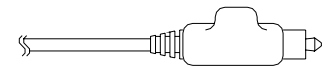

C102



Plug Spec:

ID :2.0mm
OD :5.5mm
Length :12mm
With clip

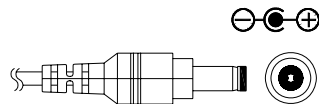

C107



Plug Spec:

ID :2.5mm
OD :5.5mm
Length :11mm
With clip

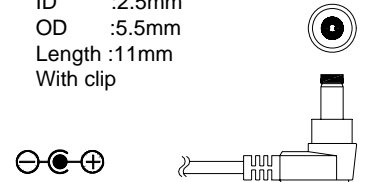

C103



Plug Spec:

ID :2.5mm
OD :5.5mm
Length :12mm
With clip

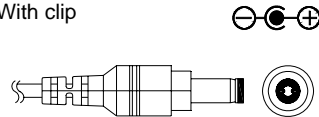

C108



Plug Spec:

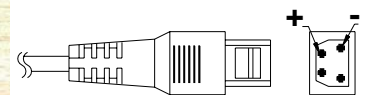

C104



Plug Spec:

ID :2.8mm
OD :6.6mm
Length :12mm
With clip

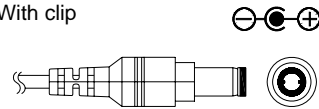

C109



Plug Spec:

ID :1.5mm
OD :5.5mm
Length :11mm

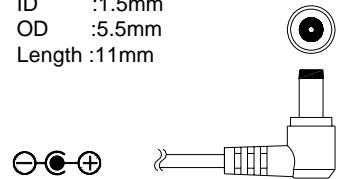

C105



Plug Spec:

ID :4.3mm
OD :6.0mm
Length :11mm

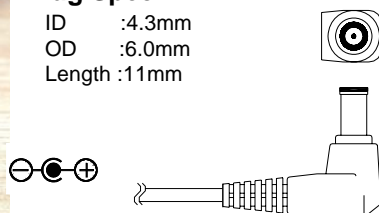

C110



Plug Spec:

ID :2.0mm
OD :5.5mm
Length :10mm
With clip

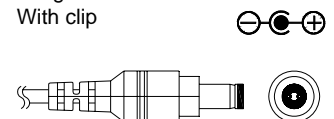

Power Systems – The Power Solution

Web: www.Power-Systems.de
Email: Info@Power-Systems.de

Address: Dörnet 8 ; 74360 Ilsfeld-Auenstein / Germany
Tel. : + 49 / 70 62 / 67 59 - 6
Fax: + 49 / 70 62 / 67 59 - 80