

Features

- For broadband applications
- Typical 3 dB bandwidth of 4.9 MHz
- High attenuation
- Single-ended operation
- Ceramic Surface Mount Package (SMP)
- Replaces Sawtek P/N 851551 (BW 3dB=4.5 MHz)
- Hermetic
- **RoHS** compliant (2002/95/EC), **Pb-free** 

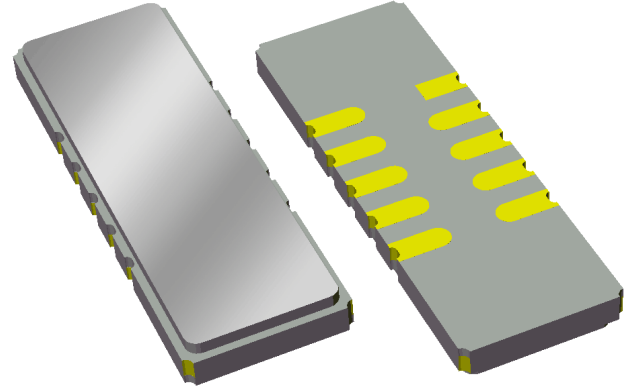

Package

Surface Mount 19.00 x 6.50 x 1.75 mm
SMP-75B

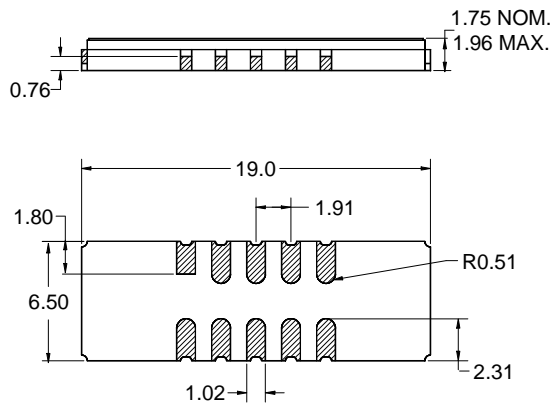

Pin Configuration

Bottom View

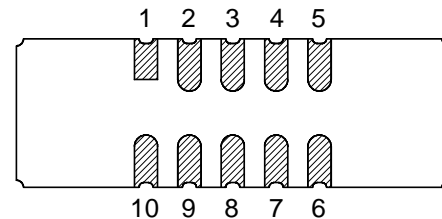

Single-ended Configuration

Pin No.	Description
5	RF output
10	RF Input
1,6	Ground
2,3,4	Case Ground
7,8,9	Case Ground

Dimensions shown are nominal in millimeters
 All tolerances are ± 0.15 mm except overall
 length and width ± 0.10 mm

Body: Al_2O_3 ceramic
 Lid: Kovar, Ni plated
 Terminations: Au plating 0.5 - 1.0 μ m,
 over a 2 - 6 μ m Ni plating

Electrical Specifications ⁽¹⁾

Operating Temperature Range: ⁽²⁾ 0 to +70 °C

Parameter ⁽³⁾	Minimum	Typical ⁽⁴⁾	Maximum	Unit
Center Frequency	-	70	-	MHz
Minimum Insertion Loss	-	23.7	25.5	dB
Lower 1 dB Bandedge ⁽⁵⁾	-	67.74	67.9	MHz
Upper 1 dB Bandedge	72.1	72.31	-	MHz
Lower 3 dB Bandedge ⁽⁵⁾	-	67.53	67.65	MHz
Upper 3 dB Bandedge	72.35	72.50	-	MHz
Lower 40 dB Bandedge ⁽⁵⁾	66.68	66.79	-	MHz
Upper 40 dB Bandedge	-	73.20	73.32	MHz
Amplitude Variation 67.9 - 72.1 MHz	-	0.71	1.15	dB p-p
Phase Linearity 67.9 - 72.1 MHz	-	3.3	5.85	deg p-p
Group Delay Variation 67.9 - 72.1 MHz	-	60	135	nsec
Absolute Delay	-	2.3	-	µsec
Relative Attenuation ⁽⁵⁾				
10 - 58 MHz	42.0	54	-	dB
58 - 65 MHz	36.5	45	-	dB
75 - 82 MHz	42.0	45	-	dB
82 - 124 MHz	42.5	53	-	dB
124 - 140 MHz	37.5	46	-	dB
140 - 200 MHz	50.0	63	-	dB
Source Impedance ⁽⁶⁾	-	50	-	Ω
Load Impedance ⁽⁶⁾	-	50	-	Ω

Notes:

1. All specifications are based on the matching schematic shown below
2. In production, devices will be tested at room temperature to a guardbanded specification to ensure electrical compliance over temperature
3. Electrical margin has been built into the design to account for the variations due to temperature drift and manufacturing tolerances
4. Typical values are based on average measurements at room temperature
5. All attenuation measurements are measured relative to minimum insertion loss
6. This is the optimum impedance in order to achieve the performance shown

Test Circuit:

Actual matching values may vary due to PCB layout and parasitics

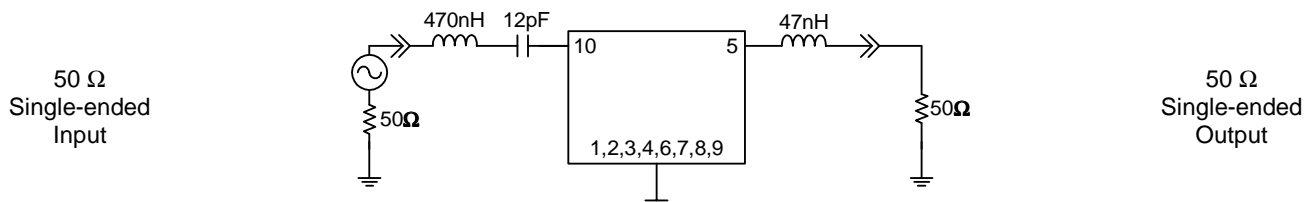

Typical Performance (at room temperature)

Frequency Response

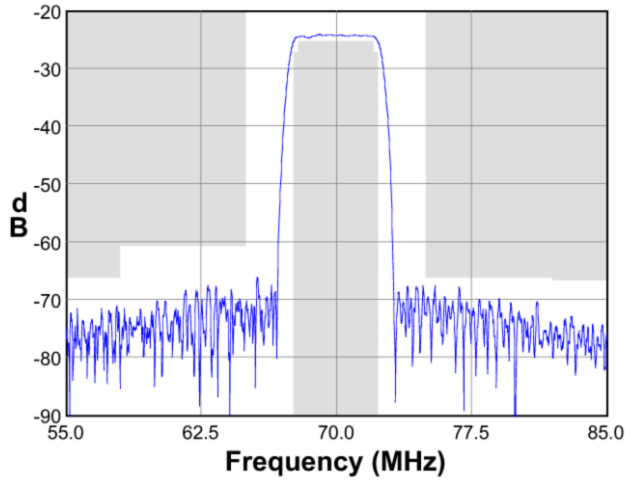

Passband Response

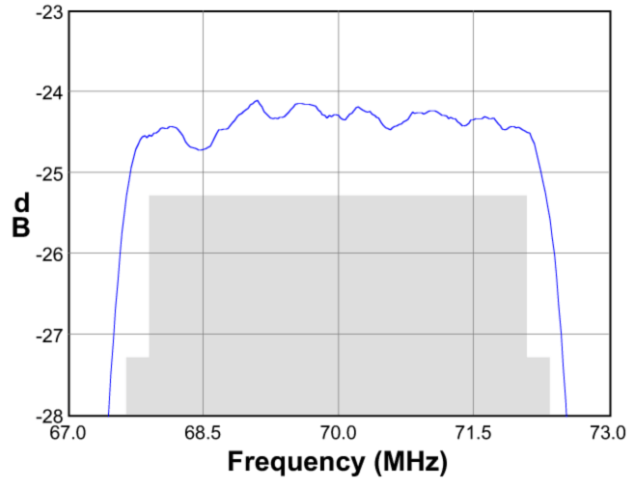

Wideband Response

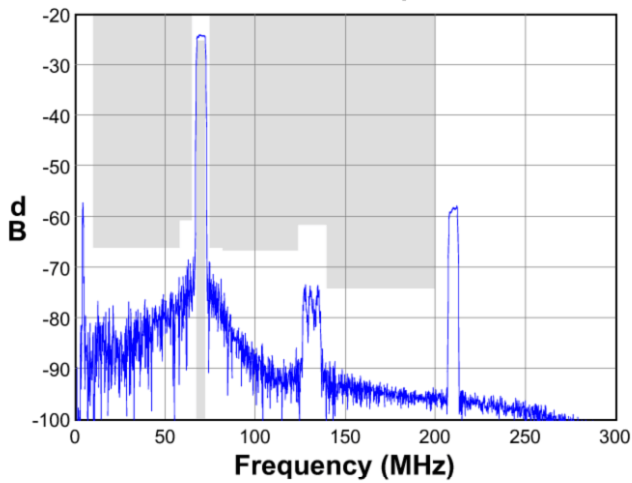

Phase Linearity

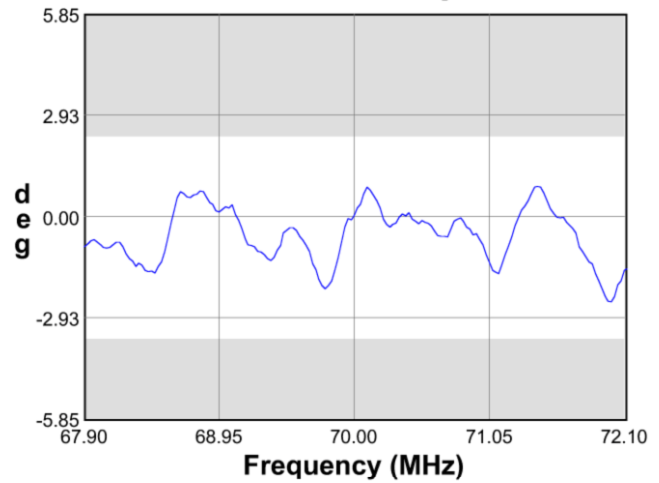

Input Smith Chart

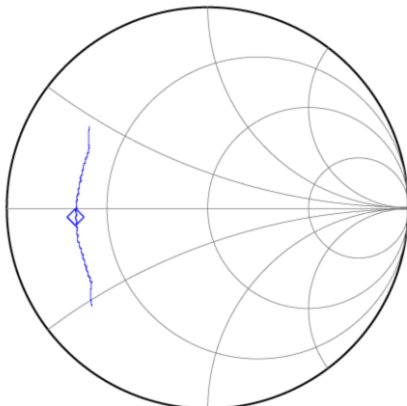

Output Smith Chart

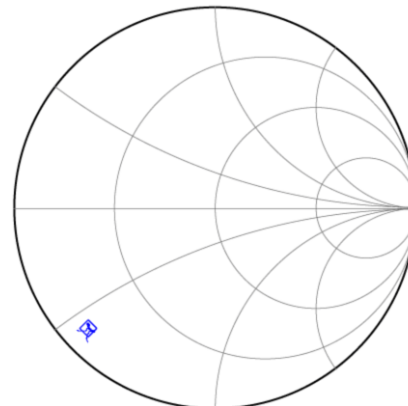

Maximum Ratings

Parameter	Symbol	Minimum	Maximum	Unit
Operating Temperature Range	T	0	+70	°C
Storage Temperature Range	T _{stg}	-40	+85	°C

Important Notes

Warnings

- Electrostatic Sensitive Device (ESD) 
- Avoid ultrasonic exposure

RoHS Compliance

- This product complies with EU directive 2002/95/EC (RoHS) 

Solderability

- Compatible with JESD22-B102, Pb-free process, 260C peak reflow temperature ([see soldering profile](#))

Links to Additional Technical Information

[PCB Layout Tips](#)

[Qualification Flowchart](#)

[Soldering Profile](#)

[S-Parameters](#)

[RoHS Information](#)

[Other Technical Information](#)

TriQuint's liability is limited only to the Surface Acoustic Wave (SAW) component(s) described in this data sheet. TriQuint does not accept any liability for applications, processes, circuits or assemblies, which are implemented using any TriQuint component described in this data sheet.

Contact Information

TriQuint 
 SEMICONDUCTOR

PO Box 609501
 Orlando, FL 32860-9501
 USA

Phone: +1 (407) 886-8860
 Fax: +1 (407) 886-7061
 Email: info-product@tqs.com
 Web: www.triquint.com

Or contact one of our worldwide
 Network of [sales offices](#),
[Representatives or distributors](#)