

2.0-18.0 GHz GaAs MMIC Buffer Amplifier

Features

- ✕ Self Bias Architecture
- ✕ On-Chip Drain Bias Coil/DC Blocking
- ✕ 9.0 dB Small Signal Gain
- ✕ 4.5 dB Noise Figure
- ✕ +19.0 dBm P1dB Compression Point
- ✕ 100% Visual Inspection to MIL-STD-883 Method 2010

Chip Device Layout

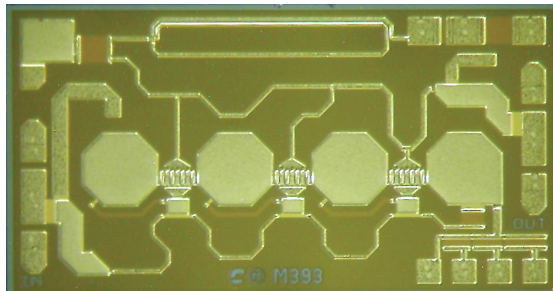

General Description

Mimix Broadband's 2.0-18.0 GHz GaAs MMIC distributed low noise amplifier has a small signal gain of 9.0 dB with a noise figure of 4.5 dB across the band. This MMIC uses Mimix Broadband's 0.3 μm GaAs PHEMT device model technology, and is based upon optical beam lithography to ensure high repeatability and uniformity. The chip has surface passivation to protect and provide a rugged part with backside via holes and gold metallization to allow either a conductive epoxy or eutectic solder die attach process. This device is well suited for fiber optic, microwave radio, military, space, telecom infrastructure, test instrumentation and VSAT applications.

Absolute Maximum Ratings

Supply Voltage (Vd)	+8.5 VDC
Supply Current (Id)	175 mA
Input Power (Pin)	+20 dBm
Storage Temperature (Tstg)	-65 to +165 °C
Operating Temperature (Ta)	-55 to MTTF Table ¹
Channel Temperature (Tch)	MTTF Table ¹

(1) Channel temperature affects a device's MTTF. It is recommended to keep channel temperature as low as possible for maximum life.

Electrical Characteristics (Ambient Temperature T = 25 °C)

Parameter	Units	Min.	Typ.	Max.
Frequency Range (f)	GHz	2.0	-	18.0
Input Return Loss (S11)	dB	-	12.0	-
Output Return Loss (S22)	dB	-	15.0	-
Small Signal Gain (S21)	dB	-	9.0	-
Gain Flatness ($\Delta S21$)	dB	-	+/-0.5	-
Reverse Isolation (S12)	dB	-	20.0	-
Noise Figure (NF)	dB	-	4.5	-
Output Power for 1 dB Compression (P1dB)	dBm	-	+19.0	-
Output Second Order Intercept Point (OIP2)	dBm	-	+39.0	-
Output Third Order Intercept Point (OIP3)	dBm	-	+29.0	-
Drain Bias Voltage (Vd)	VDC	+4.5	+5.0	+7.0
Supply Current (Id) (Vd=5.0V)	mA	100	115	130

100% on-wafer DC testing and 100% RF wafer qualification. Wafer qualification includes sample testing from each quadrant with an 80% pass rate required.

2.0-18.0 GHz GaAs MMIC Buffer Amplifier

Buffer Amplifier Measurements

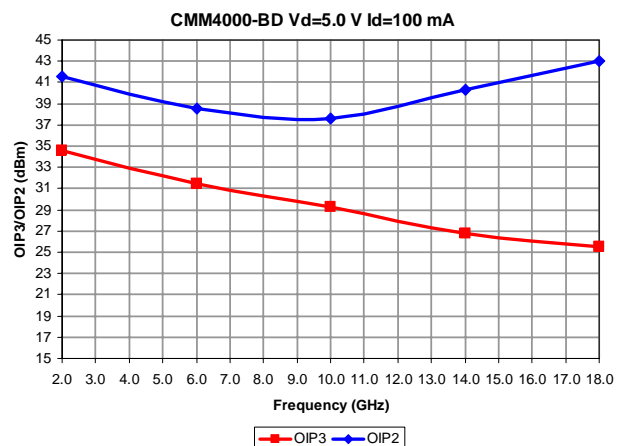
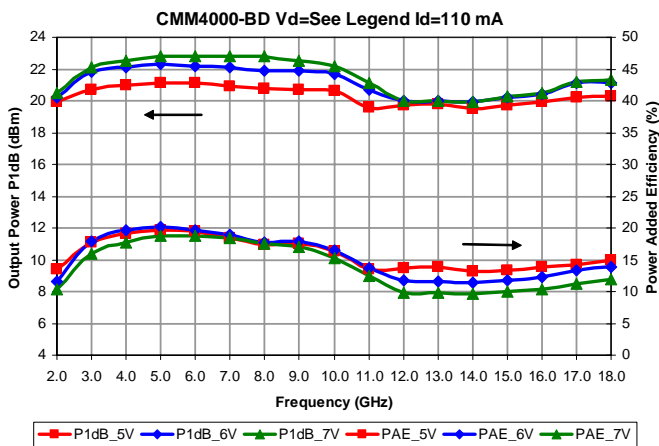
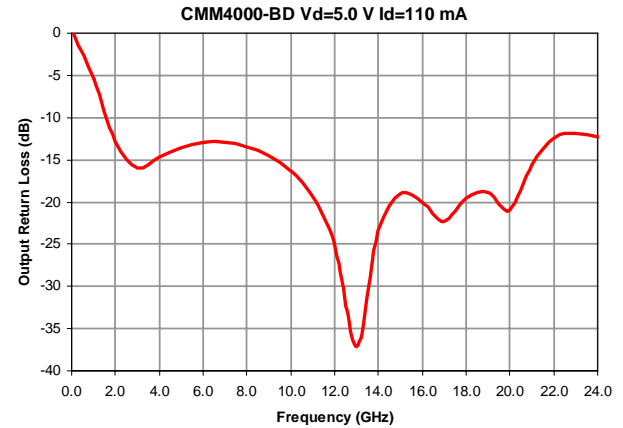
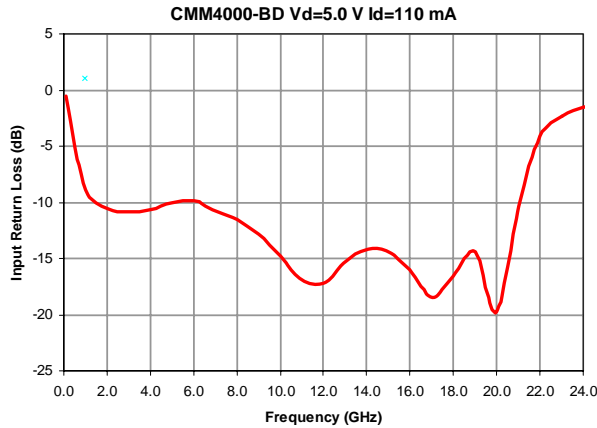
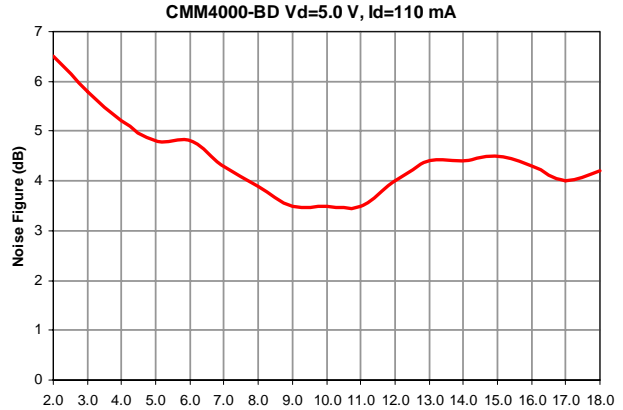
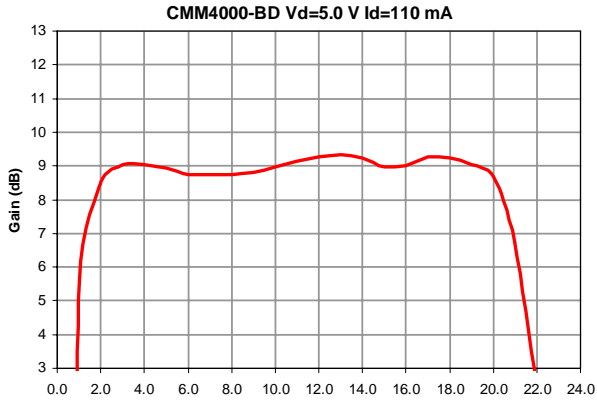

2.0-18.0 GHz GaAs MMIC Buffer Amplifier

May 2007 - Rev 01-May-07



CMM4000-BD

Buffer Amplifier Measurements (cont,)

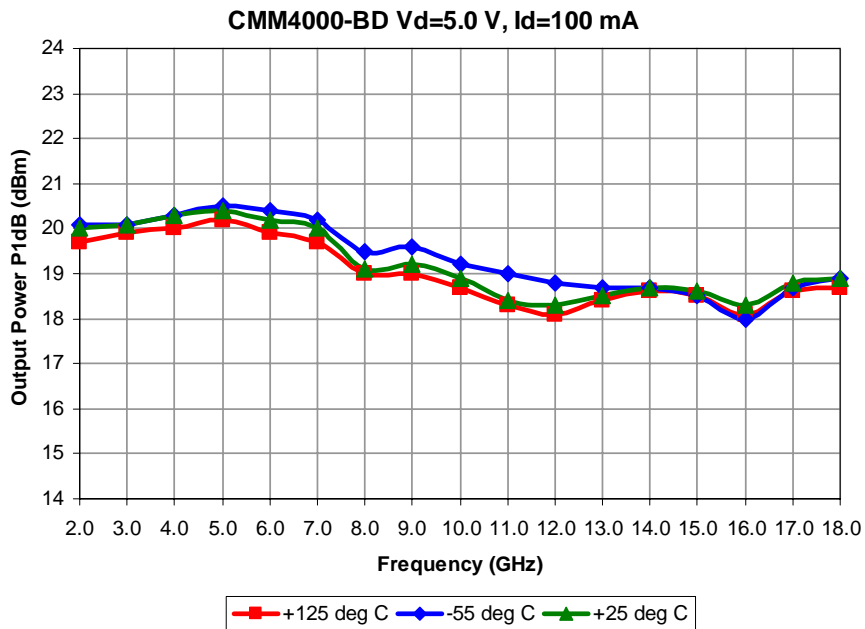
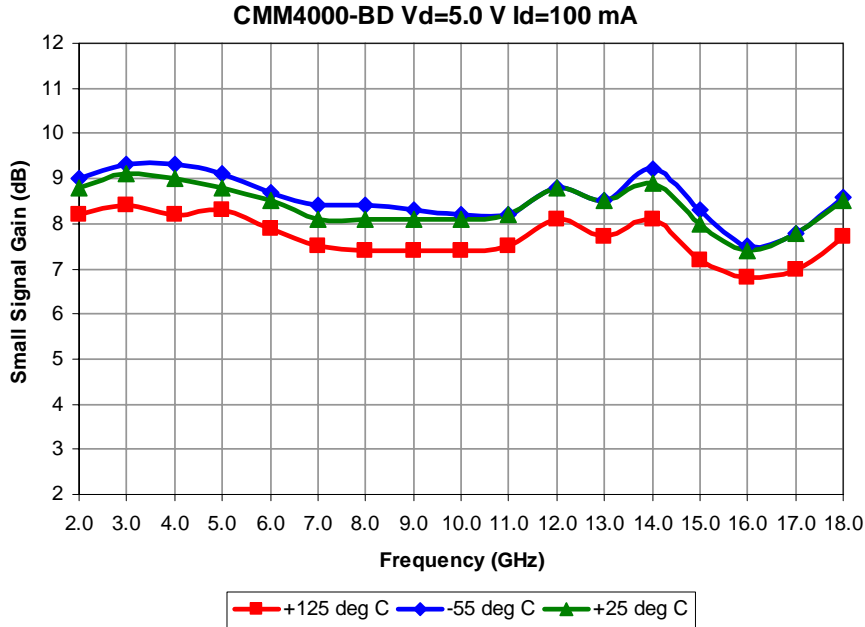

2.0-18.0 GHz GaAs MMIC Buffer Amplifier

S-Parameters

Typical S-Parameter Data for CMM4000

Vd=5.0 V Id=110 m A

Frequency (GHz)	S11 (Mag)	S11 (Ang)	S21 (Mag)	S21 (Ang)	S12 (Mag)	S12 (Ang)	S22 (Mag)	S22 (Ang)
0.1	0.939	-28.86	0.030	117.39	0.000	133.12	0.983	118.74
1.0	0.364	-132.15	1.904	-171.74	0.005	-60.12	0.534	-87.11
2.0	0.296	-154.45	2.668	-105.50	0.010	-5.71	0.229	-64.48
3.0	0.286	-160.46	2.828	-70.66	0.018	18.16	0.160	-81.40
4.0	0.292	-165.78	2.828	-44.41	0.022	44.37	0.185	-91.05
5.0	0.315	-170.64	2.797	-22.20	0.026	64.72	0.209	-89.28
6.0	0.320	-179.10	2.736	-1.45	0.030	76.12	0.225	-84.50
7.0	0.290	174.17	2.741	16.88	0.036	97.10	0.225	-74.33
8.0	0.266	167.95	2.740	35.36	0.040	112.34	0.212	-65.50
9.0	0.228	162.72	2.762	53.73	0.045	127.57	0.188	-56.22
10.0	0.181	161.86	2.806	72.32	0.050	143.05	0.153	-46.48
11.0	0.144	170.52	2.862	91.58	0.056	159.35	0.108	-37.11
12.0	0.139	-173.68	2.911	111.73	0.062	176.77	0.056	-30.81
13.0	0.171	-168.09	2.934	132.75	0.068	-164.72	0.014	-113.48
14.0	0.194	-177.47	2.900	154.42	0.072	-145.03	0.068	-151.52
15.0	0.190	164.69	2.814	175.34	0.075	-126.55	0.112	-133.14
16.0	0.159	135.47	2.816	-164.76	0.080	-108.43	0.099	-114.04
17.0	0.120	77.24	2.903	-141.37	0.087	-87.59	0.077	-134.21
18.0	0.148	0.06	2.899	-115.02	0.092	-63.43	0.106	-143.64
19.0	0.191	-50.22	2.832	-86.80	0.095	-37.36	0.113	-137.82
20.0	0.103	-69.38	2.720	-53.34	0.096	-5.72	0.089	-152.93
21.0	0.305	-2.05	2.171	-11.92	0.080	34.73	0.166	-175.57
22.0	0.623	-38.06	1.302	21.15	0.048	66.50	0.241	-156.77
23.0	0.768	-63.85	0.764	40.26	0.029	85.11	0.254	-141.68
24.0	0.840	-81.23	0.475	52.76	0.017	92.79	0.243	-132.25
25.0	0.878	-93.97	0.303	60.92	0.010	100.58	0.227	-127.37
26.0	0.908	-103.83	0.197	61.87	0.006	93.67	0.209	-126.41
27.0	0.927	-112.29	0.147	53.60	0.005	60.51	0.201	-128.78
28.0	0.939	-119.49	0.148	48.15	0.007	51.59	0.204	-132.36
29.0	0.941	-125.43	0.158	55.22	0.007	68.77	0.219	-134.50
30.0	0.946	-130.57	0.155	69.84	0.008	84.14	0.238	-132.64

2.0-18.0 GHz GaAs MMIC Buffer Amplifier

Mechanical Drawing

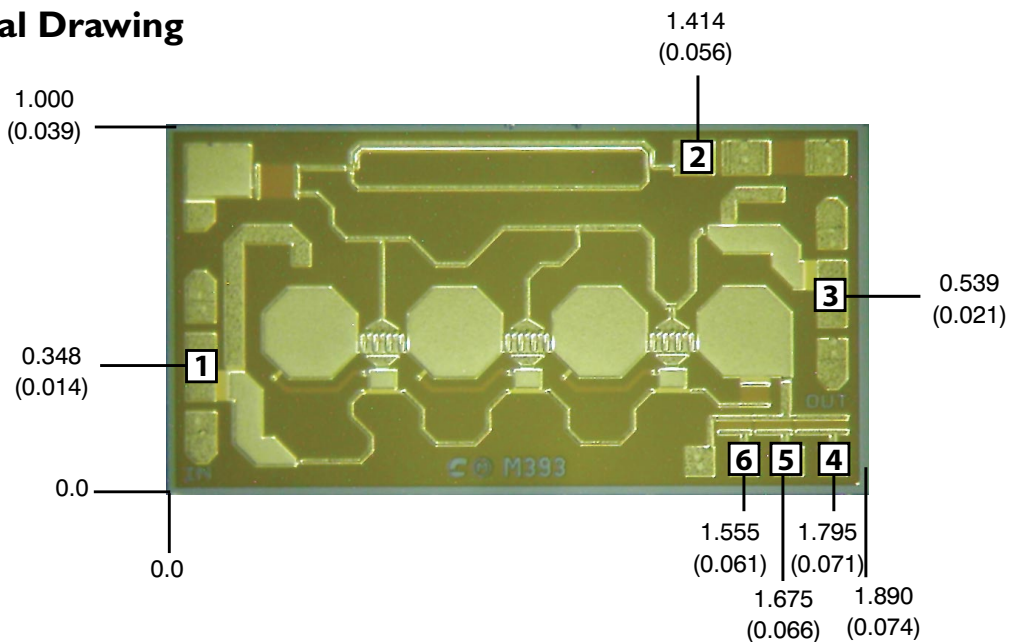

Units: millimeters (inches) Bond pad dimensions are shown to center of bond pad.
 Thickness: 0.076 +/- 0.010 (0.003 +/- 0.0004), Backside is ground, Bond Pad/Backside Metallization: Gold
 All DC Bond Pads are 0.080 x 0.080 (0.003 x 0.003). All RF Bond Pads are 0.180 x 0.080 (0.007 x 0.003).
 Bond pad centers are approximately 0.109 (0.004) from the edge of the chip.
 Dicing tolerance: +/- 0.005 (+/- 0.0002). Approximate weight: 1.172 mg

Bond Pad #1 (RF In)	Bond Pad #3 (RF Out)	Bond Pad #5 (Rs-12Ω)
Bond Pad #2 (Vd)	Bond Pad #4 (Rs-8.5Ω)	Bond Pad #6 (Rs-13Ω)

Bias Arrangement

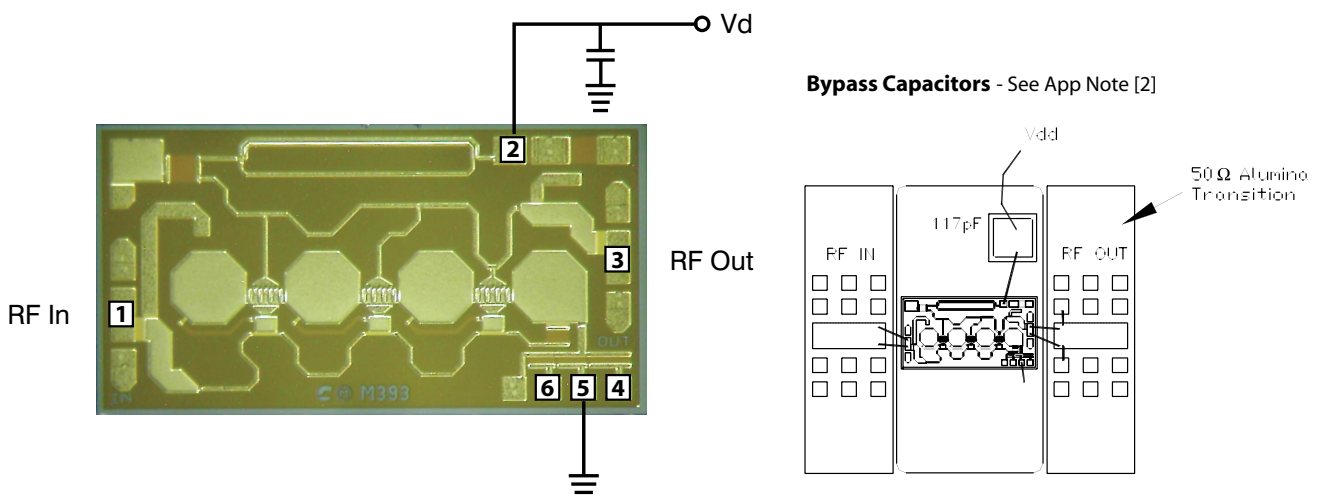

2.0-18.0 GHz GaAs MMIC Buffer Amplifier



May 2007 - Rev 01-May-07

CMM4000-BD

App Note [1] Biasing - As shown in the bonding diagram, this device operates using a self-biased architecture and only requires one drain bias. Bias is nominally $V_d=5V$, $I_d=115mA$. Additionally there are three source resistors on chip, 13, 12 and 8.5 Ohms. One of these must be bonded to ground. Typically 12 Ohms is bonded to ground to achieve performance as shown. Bonding to one of the other resistors or any or all in parallel may allow additional performance adjustment.

App Note [2] Bias Arrangement - Each DC pad (V_d) needs to have DC bypass capacitance ($\sim 100-200$ pF) as close to the device as possible. Additional DC bypass capacitance (~ 0.01 uF) is also recommended.

MTTF Graphs

These numbers were calculated based on accelerated life test information and thermal model analysis received from the fabricating foundry.

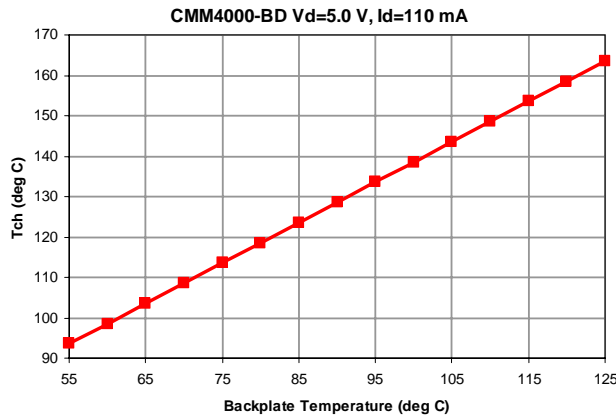
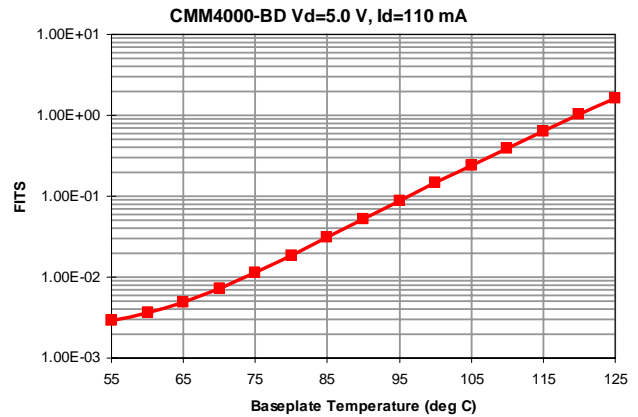
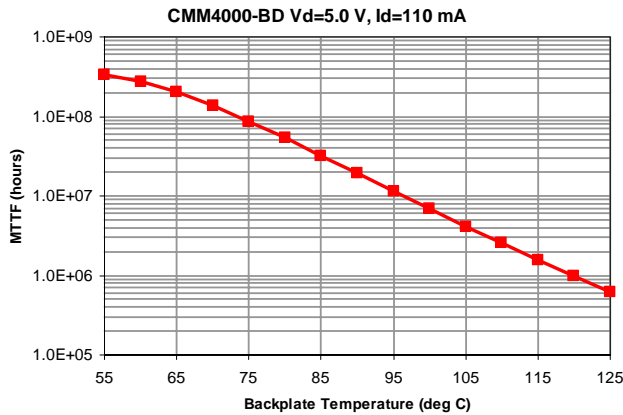

2.0-18.0 GHz GaAs MMIC Buffer Amplifier



CMM4000-BD

May 2007 - Rev 01-May-07

Handling and Assembly Information

CAUTION! - Mimix Broadband MMIC Products contain gallium arsenide (GaAs) which can be hazardous to the human body and the environment. For safety, observe the following procedures:

- *Do not ingest.*
- *Do not alter the form of this product into a gas, powder, or liquid through burning, crushing, or chemical processing as these by-products are dangerous to the human body if inhaled, ingested, or swallowed.*
- *Observe government laws and company regulations when discarding this product. This product must be discarded in accordance with methods specified by applicable hazardous waste procedures.*

Life Support Policy - Mimix Broadband's products are not authorized for use as critical components in life support devices or systems without the express written approval of the President and General Counsel of Mimix Broadband. As used herein: (1) Life support devices or systems are devices or systems which, (a) are intended for surgical implant into the body, or (b) support or sustain life, and whose failure to perform when properly used in accordance with instructions for use provided in the labeling, can be reasonably expected to result in a significant injury to the user. (2) A critical component is any component of a life support device or system whose failure to perform can be reasonably expected to cause the failure of the life support device or system, or to affect its safety or effectiveness.

ESD - Gallium Arsenide (GaAs) devices are susceptible to electrostatic and mechanical damage. Die are supplied in antistatic containers, which should be opened in cleanroom conditions at an appropriately grounded antistatic workstation. Devices need careful handling using correctly designed collets, vacuum pickups or, with care, sharp tweezers.

Die Attachment - GaAs Products from Mimix Broadband are 0.076 mm (0.003") thick and have vias through to the backside to enable grounding to the circuit. Microstrip substrates should be brought as close to the die as possible. The mounting surface should be clean and flat. If using conductive epoxy, recommended epoxies are Tanaka TS3332LD, Die Mat DM6030HK or DM6030HK-Pt cured in a nitrogen atmosphere per manufacturer's cure schedule. Apply epoxy sparingly to avoid getting any on to the top surface of the die. An epoxy fillet should be visible around the total die periphery. For additional information please see the Mimix "Epoxy Specifications for Bare Die" application note. If eutectic mounting is preferred, then a fluxless gold-tin (AuSn) preform, approximately 0.001" thick, placed between the die and the attachment surface should be used. A die bonder that utilizes a heated collet and provides scrubbing action to ensure total wetting to prevent void formation in a nitrogen atmosphere is recommended. The gold-tin eutectic (80% Au 20% Sn) has a melting point of approximately 280° C (Note: Gold Germanium should be avoided). The workstation temperature should be 310°C +/- 10°C. Exposure to these extreme temperatures should be kept to minimum. The collet should be heated, and the die pre-heated to avoid excessive thermal shock. Avoidance of air bridges and force impact are critical during placement.

Wire Bonding - Windows in the surface passivation above the bond pads are provided to allow wire bonding to the die's gold bond pads. The recommended wire bonding procedure uses 0.076 mm x 0.013 mm (0.003" x 0.0005") 99.99% pure gold ribbon with 0.5-2% elongation to minimize RF port bond inductance. Gold 0.025 mm (0.001") diameter wedge or ball bonds are acceptable for DC Bias connections. Aluminum wire should be avoided. Thermo-compression bonding is recommended though thermosonic bonding may be used providing the ultrasonic content of the bond is minimized. Bond force, time and ultrasonics are all critical parameters. Bonds should be made from the bond pads on the die to the package or substrate. All bonds should be as short as possible.

Part Number for Ordering	Description
CMM4000-BD-000V	RoHS compliant die packed in vacuum release gel packs
PB-CMM4000-BD-0000	CMM4000-BD evaluation module

Mimix Broadband, Inc., 10795 Rockley Rd., Houston, Texas 77099
Tel: 281.988.4600 Fax: 281.988.4615 mimixbroadband.com

Page 7 of 7

Characteristic Data and Specifications are subject to change without notice. ©2007 Mimix Broadband, Inc.
Export of this item may require appropriate export licensing from the U.S. Government. In purchasing these parts, U.S. Domestic customers accept their obligation to be compliant with U.S. Export Laws.