

Distinctive Characteristics

Square, round, rectangular, and round panel seal models available.

Stainless steel clips provide secure mounting with a wide range of panel thicknesses.

Latchdown feature gives indication of circuit status. Audible and tactile feedback with smooth and responsive operation.

Snap-action contact mechanism gives long electrical life and sensitivity of actuation.

Combination solder lug and .110" quick connect terminals are epoxy sealed to prevent entry of flux, dust, and other contaminants.

Panel sealed model meets IP65 of IEC60529 specifications (similar to NEMA 4 & 13).

Compact switch design minimizes behind panel depth.

Matching illuminated models available and shown in the Illuminated Pushbutton section.

Matching indicators available and shown at the end of Section M.

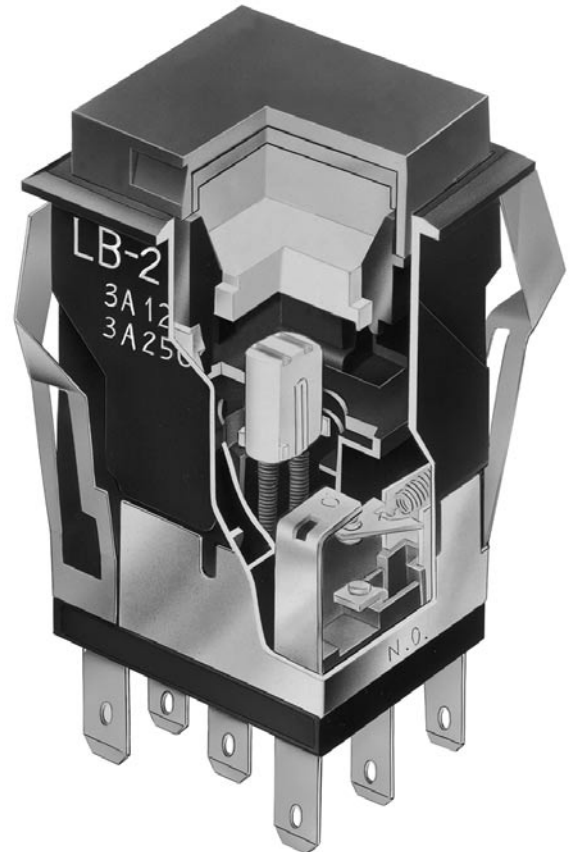

Actual Size

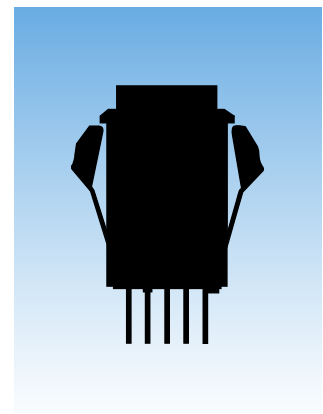

General Specifications

Electrical Capacity (Resistive Load)

Power Level (silver): 3A @ 125V AC or 3A @ 250V AC or 3A @ 30V DC
Logic Level (gold): 0.4VA maximum @ 28V AC/DC maximum
 (Applicable Range 0.1mA ~ 0.1A @ 20mV ~ 28V)
 Note: Find additional explanation in Supplement section.

Other Ratings

Contact Resistance: 50 milliohms maximum for silver; 100 milliohms maximum for gold
Insulation Resistance: 200 megohms minimum @ 500V DC
Dielectric Strength: 1,000V AC minimum between contacts for 1 minute minimum;
 1,500V AC minimum between contacts & case for 1 minute minimum
Mechanical Life: 1,000,000 operations minimum for momentary circuit
 200,000 operations minimum for maintained circuit
Electrical Life: 100,000 operations minimum
Nominal Operating Force: 4.41N
Contact Timing: Nonshorting (break-before-make)
Travel: Pretravel .059" (1.5mm); Overtravel .059" (1.5mm); Total Travel .118" (3.0mm)
 Pretravel .087" (2.2mm); Overtravel .031" (0.8mm); Total Travel .118" (3.0mm)

Materials & Finishes

Housing: Glass fiber reinforced polyamide (UL94V-0)
Snap-in Frame: Stainless steel
Movable Contact: Silver alloy or copper with gold plating
Stationary Contacts: Silver alloy or copper with gold plating
Base: Liquid crystal polymer (UL94V-0)
Terminals: Phosphor bronze with silver or gold plating

Environmental Data

Operating Temp Range: -25°C through +70°C (-13°F through +158°F)
 Note: When used with a polyvinyl chloride splash cover, the lowest limit is 0°C (32°F)
Humidity: 90 ~ 95% humidity for 96 hours @ 40°C (104°F)
Vibration: 10 ~ 55Hz with peak-to-peak amplitude of 1.5mm traversing the frequency range & returning in 1 minute; 3 right angled directions for 2 hours
Shock: 50G (490m/s²) acceleration (tested in 6 right angled directions, with 5 shocks in each direction)
Sealing: Not available for snap-in; see next section for panel seal.

Installation

Cap Installation Force: 3.92N maximum downward force on cap
Quick Connect Force: 52.95N maximum downward force on connector
Soldering Time & Temperature: Manual Soldering: See Profile A in Supplement section.

Standards & Certifications



Flammability Standards: UL94V-0 housing & base
UL & C-UL Recognized: All models recognized at 3A @ 125V or 250V AC or 0.4VA @ 28V AC/DC maximum;
 UL File No. WOYR2.E44145; add "/U" to end of part number to order UL mark on switch;
 C-UL File No. WOYR8.E44145; add "/C-UL" to end of part number to order C-UL mark on switch.
CSA Certified: All models certified at 3A @ 125V or 250V AC or 0.4VA @ 28V AC/DC maximum;
 CSA File Nos. 023535-0-000; add "/C" to end of part number to order CSA mark on switch.

TYPICAL SWITCH ORDERING EXAMPLE

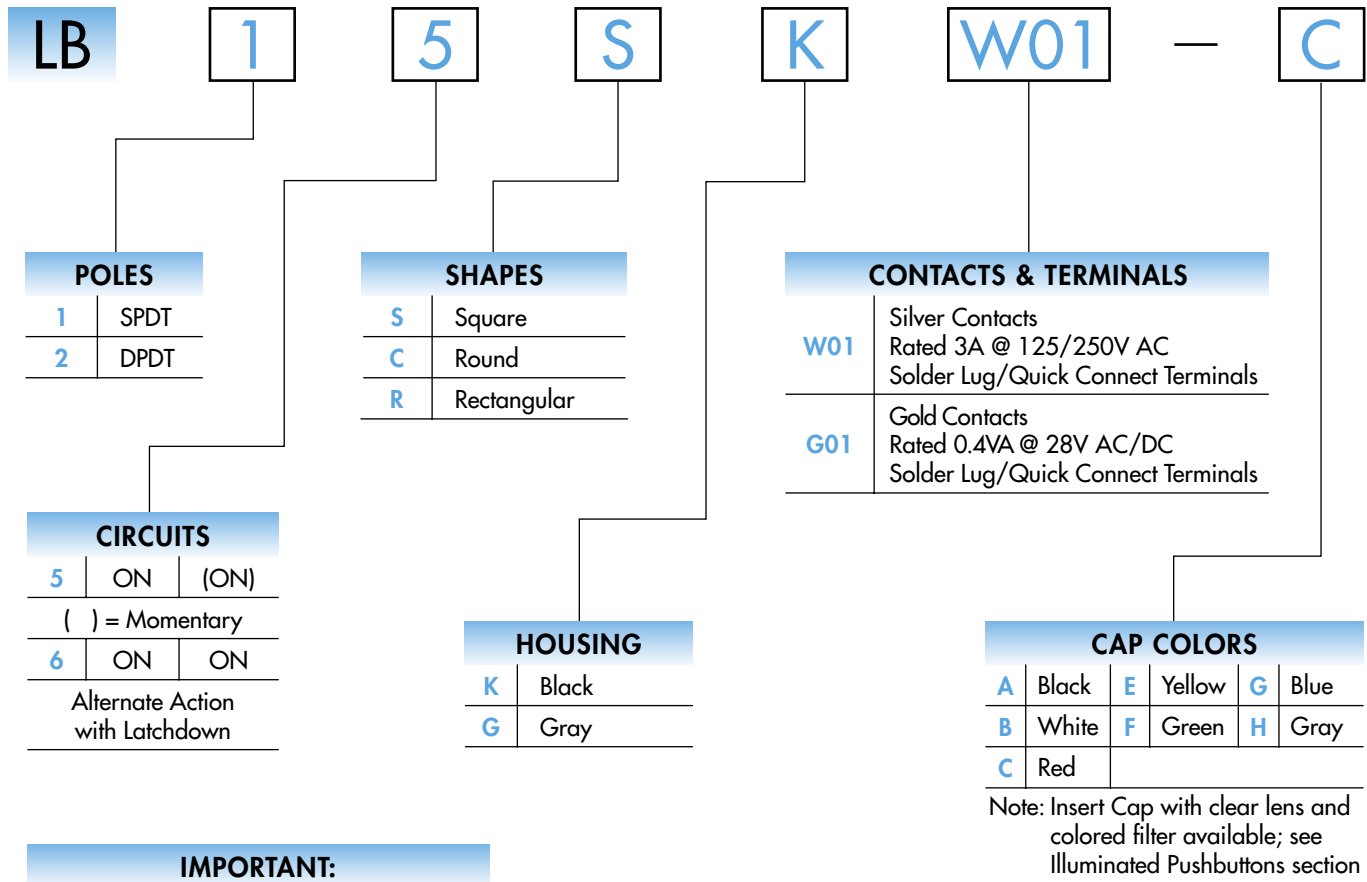

IMPORTANT:



Switches are supplied without UL, C-UL & CSA markings unless specified. Specific models & ratings noted on General Specifications page.

DESCRIPTION FOR TYPICAL ORDERING EXAMPLE

LB15SKW01-C

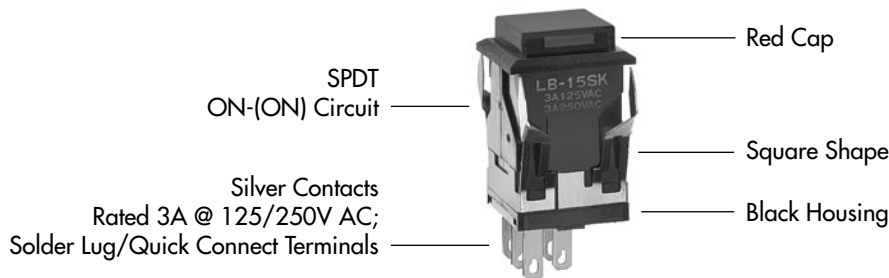

POLES & CIRCUITS

Pole	Model	Plunger Position () = Momentary		Connected Terminals		Throw & Switch/Lamp Schematics
		Normal	Down	Normal	Down	
SP	LB15 *LB16	ON ON	(ON) ON	1-3	1-2	SPDT
DP	LB25 *LB26	ON ON	(ON) ON	1-3 4-6	1-2 4-5	DPDT

* When in latchdown position for the alternate circuit, cap position is .039" (1.0mm) above the built-in bezel.

SHAPES & PANEL CUTOUTS

S .622" (15.8mm)
Square

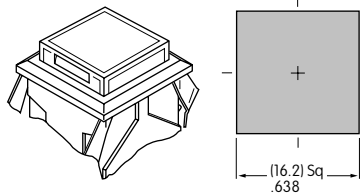

Cutout for 1 switch:
.638" x .638" (16.2mm x 16.2mm)
Cutout for 1 switch with barriers:
.638" x .815" (16.2mm x 20.7mm)

C .854" (21.7mm)
Round

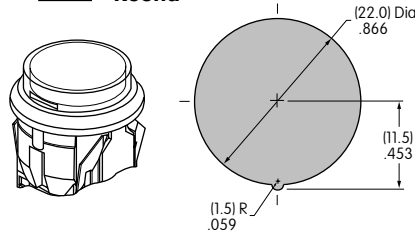

R .622" x .866" (15.8mm x 22.0mm)
Rectangular

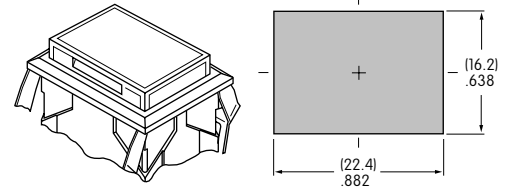

Cutout for 1 switch:
.638" x .882" (16.2mm x 22.4mm)
Cutout for 1 switch with barriers:
.638" x 1.059" (16.2mm x 26.9mm)

Panel Thickness for Switches & Barriers: .039" ~ .157" (1.0 ~ 4.0mm)
Panel Thickness for Protective Guards & Splash Covers: .039" ~ .138" (1.0 ~ 3.5mm)

HOUSING

Housing Colors Available:

K Black

G Gray

CONTACT MATERIALS, RATINGS & TERMINALS

W01 Silver Contacts

Power Level
3A @ 125V AC & 250V AC

Solder Lug/Quick Connect

G01 Gold Contacts

Logic Level
0.4VA max. @ 28V AC/DC max.

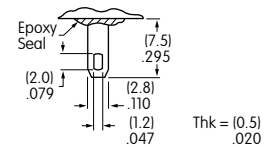

Complete explanation of operating range in Supplement section.

CAPS & CAP COLORS

Color Codes: A Black B White C Red E Yellow F Green G Blue H Gray

Cap Colors Available:

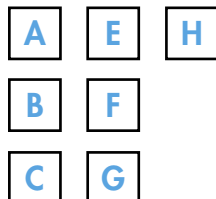

AT484
Square

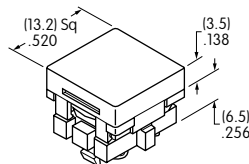

AT4017
Round

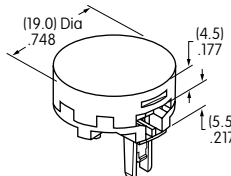

AT4030
Rectangular

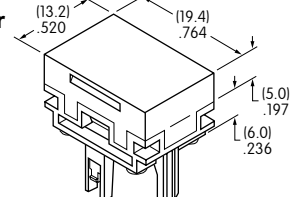

Material: Polycarbonate Finish: Glossy

TYPICAL SWITCH DIMENSIONS

Square

Single & Double Pole

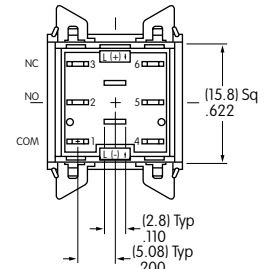
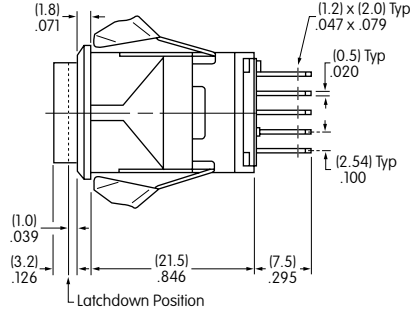
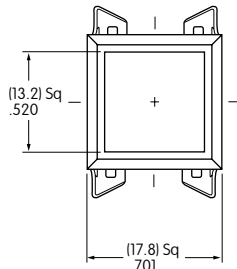

LB15SKW01-C

Single pole models do not have terminals 4, 5, & 6.

Round

Single & Double Pole

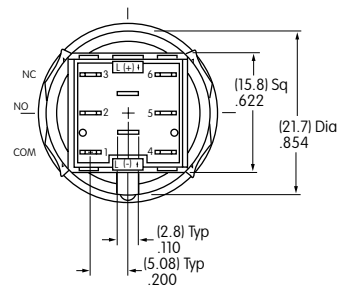
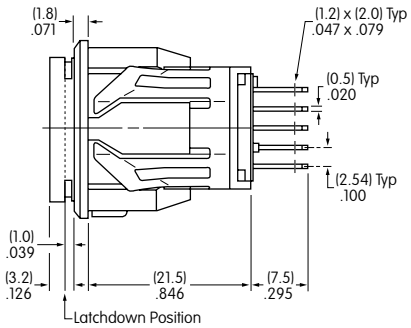
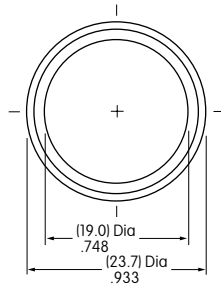

LB16CKW01-C

Single pole models do not have terminals 4, 5, & 6.

Rectangular

Single & Double Pole

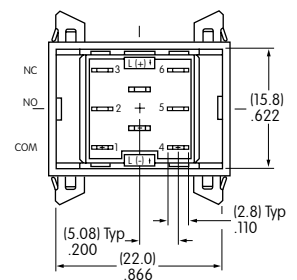
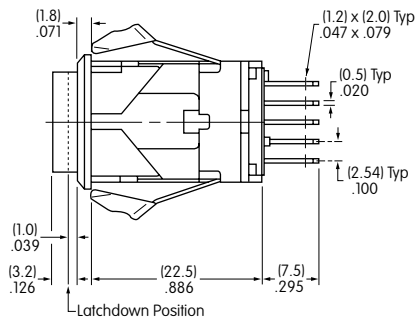
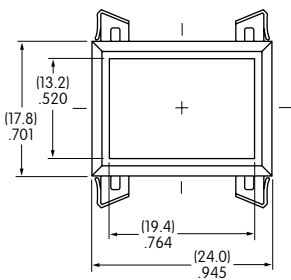

LB26RGW01-C

Single pole models do not have terminals 4, 5, & 6.

OPTIONAL ACCESSORIES

Barriers

AT497
End

AT498
Center

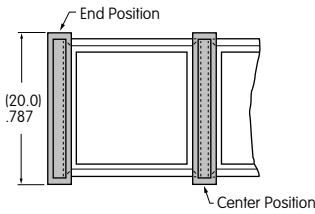

Material: Polyamide

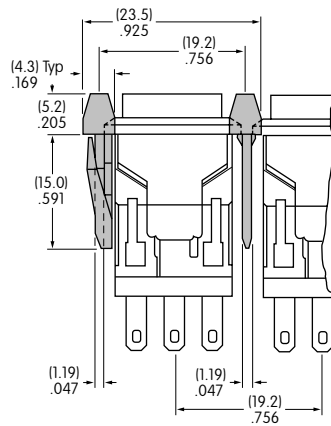

Cutouts for More Than 1 Switch

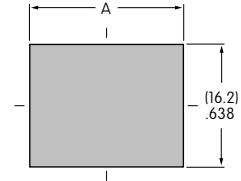

Square

$$A = .752" (19.1\text{mm}) \times \text{Number of Switches} + .051" (1.3\text{mm})$$

Rectangular

$$A = .996" (25.3\text{mm}) \times \text{Number of Switches} + .051" (1.3\text{mm})$$

Protective Guard

AT499
Square
Protective Guard

Opens 90°
Closes manually

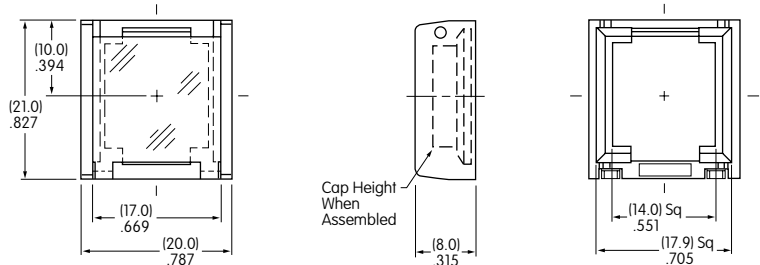

Materials:
Cover: Clear Polycarbonate
Base: Black GFR Polyamide

Protective Guards reduce depth of switch behind panel by .020" (0.5mm).

Spring Loaded Protective Guard

AT4171
Square
Protective Guard

Opens 180°
Closes automatically

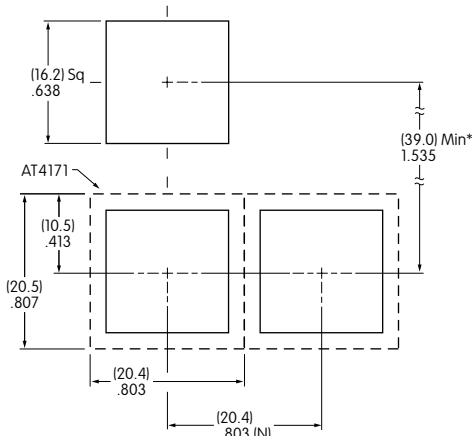
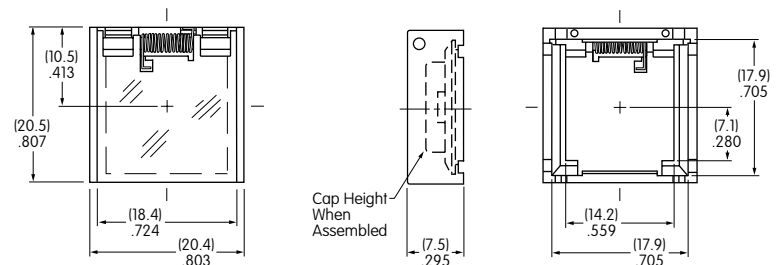
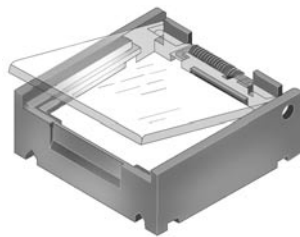

(N) = Number of switches * Minimum dimension allows opening of cover to 180°

Materials:
Cover: Clear Polycarbonate
Base: Black GFR Polyamide
Coil Spring: Stainless Steel

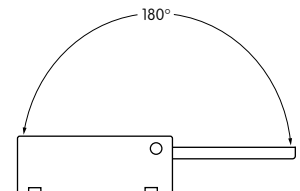

Recommended Panel Thickness:
.039" ~ .106" (1.0mm ~ 2.7mm)

OPTIONAL ACCESSORIES

Protective Guard

AT4057

**Rectangular
Protective Guard**

Opens 90°
Closes manually

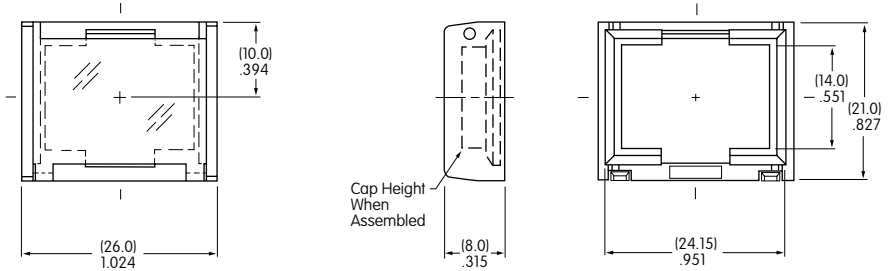

Materials:

Cover: Clear Polycarbonate
Base: Black GFR Polyamide

Protective Guards reduce depth of switch behind panel by .020" (0.5mm).

Spring Loaded Protective Guard

AT4172

**Rectangular
Protective Guard**

Opens 180°
Closes automatically

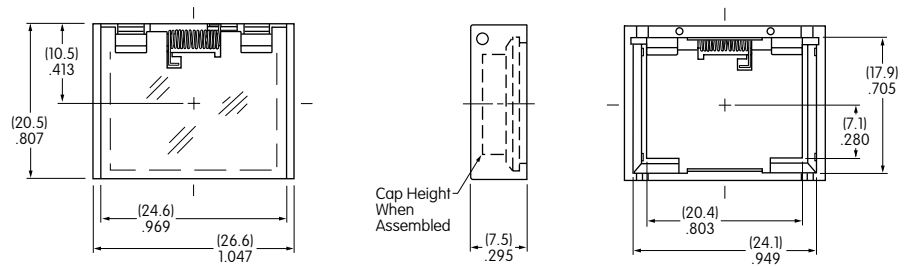

Materials:

Cover: Clear Polycarbonate
Base: Black GFR Polyamide
Coil Spring: Stainless Steel

Recommended Panel Thickness: .039" ~ .106" (1.0mm ~ 2.7mm)

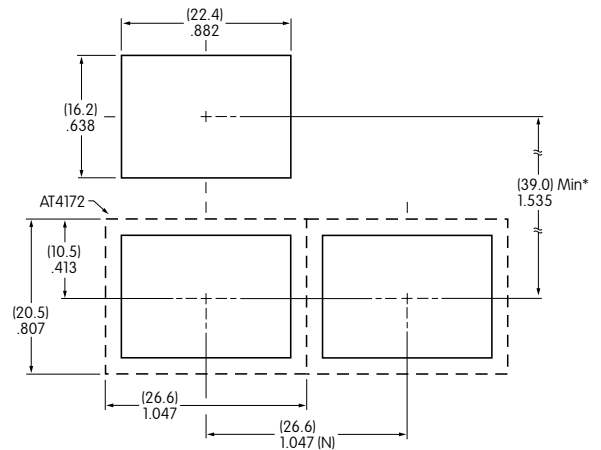
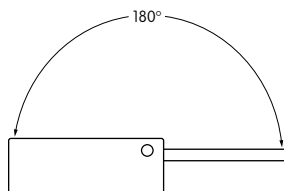

(N) = Number of switches * Minimum dimension allows opening of cover to 180°

OPTIONAL ACCESSORIES

Dust Covers

AT4002
Round



AT4001
Square

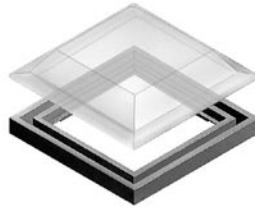

AT4011
Rectangular

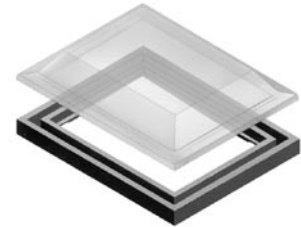

Materials:
Lid: Polyvinyl chloride
Gasket: Polyethylene

PVC loses pliability below 0°C (32°F).

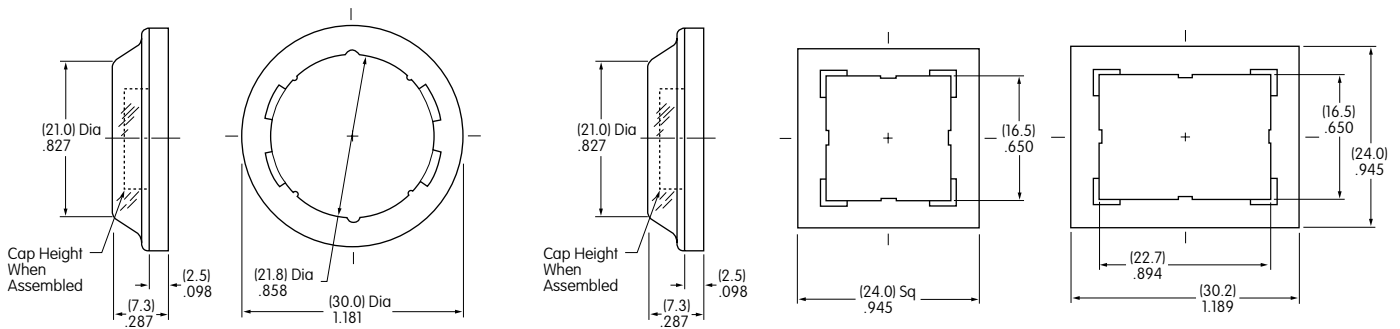

Dust Covers reduce depth of switch behind panel by .020" (0.5mm).

PCB Adaptors

AT711 Single Pole • Straight PC Terminals

AT712 Double Pole • Straight PC Terminals

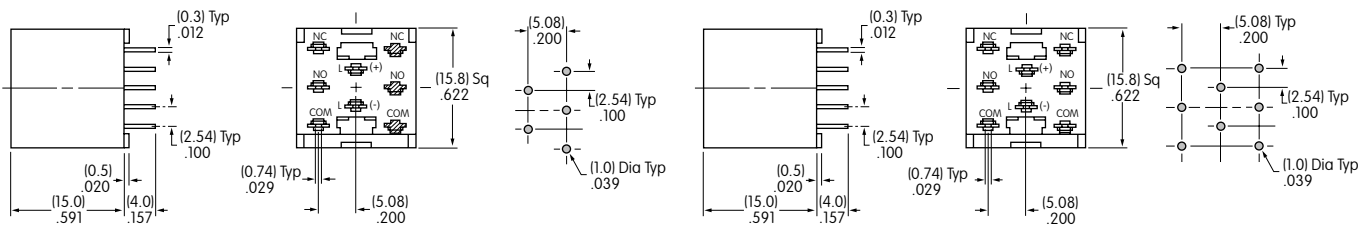

Note: Order adaptors separately.

ASSEMBLY INSTRUCTIONS

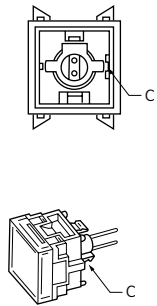

Square

Match projection (C) on cap assembly with groove (C) inside switch.

Round & Rectangular
Match clip on cap assembly with receptacle inside switch.

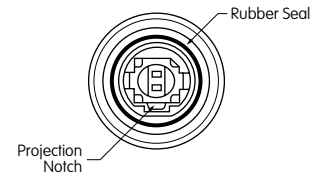
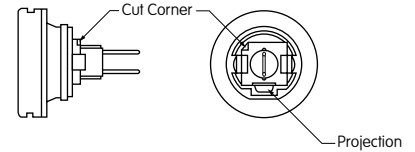
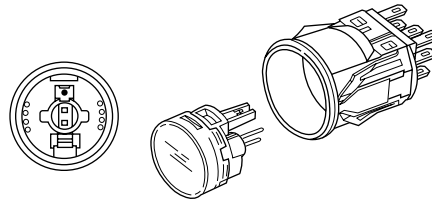

Panel Seal

Match projection on cap assembly with notch inside switch.

Snap-in Mount

Snap-in clip holds all switches firmly in place. To mount round switch, match the antirotation projection on switch with guide cut in panel. Snap into panel cutout.

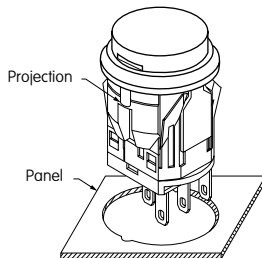

Panel Seal Bushing Mount

Insert switch from the front of the panel with the o-ring between the built-in bezel and the panel. Install mounting nut AT075 (supplied with switch) from the rear of the panel. Overtightening mounting nut may damage the switch housing.

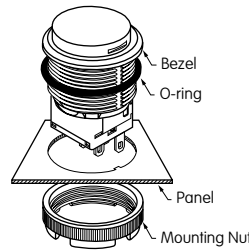

AT109
Cap Extractor



AT112
Socket Wrench

LEGENDS

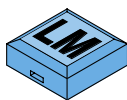

Easily create and submit your own legends using our new on-line Legend Maker.

Visit www.nkkswitches.com

For other legend support options, customers may either contact the factory and request the LB Legend Packet, or utilize the general information and basic specifications presented below.

Suggested Printable Area for LB Lens

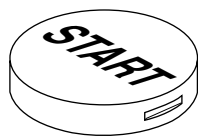

Recommended Methods:

Laser Etch on clear lens;
Screen Print or Pad Print on lens.
Epoxy based ink is recommended.

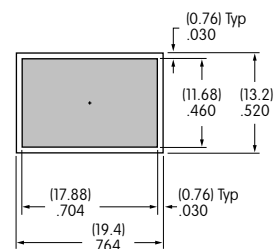
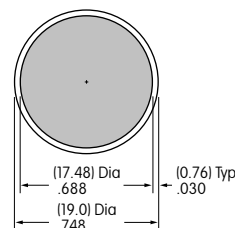
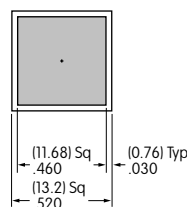

Shaded areas are printable areas.

Additional Method

Additional method for legends is engraving the cap. Maximum depth for engraving is .012" (0.3mm) on the cap lens. Enamel paint is recommended to fill the engraved area.