



soberton inc.

WSP WATER RESISTANT SPEAKER

Acoustic Product Specification

Product Number: WSP-5090

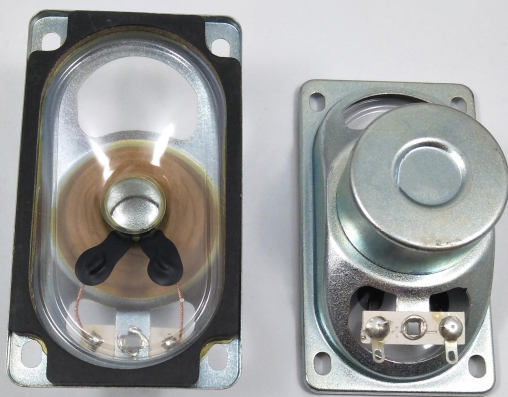

Release | Revision: A/2018

CONTENTS

This document contains the technical specifications for the water resistant speaker

Page 1

Specifications

Dimensions

Frequency Response

Specifications

Specification	Unit	WSP-5090
AC Impedance	Ω	8 \pm 15% at 1000Hz
Rated Input Power	Watt	5.0
Max Input Power	Watt	6.0
Resonant Frequency	Hz	330 \pm 20%
Frequency Range	Hz	F0~19.0KHz, average SPL \pm 10dB
Output Sound Pressure Level	dB	91 \pm 3dB 1.0 Watt/10 cm, AVG. at 0.8, 1.0, 1.2, 1.5KHz
Operating Temperature	$^{\circ}$ C	-20 $^{\circ}$ C ~ +50 $^{\circ}$ C
Storage Temperature	$^{\circ}$ C	-40 $^{\circ}$ C ~ +60 $^{\circ}$ C
Dimension	mm	90.2 x 50.1 x H31.4
Distortion		3% maximum at 1000Hz, 5.0W
Polarity		Diaphragm shall move forward when a positive DC current is applied to the "+" or "Marked" terminal
Load Test		Audio Signal Generator at 6.3 Volt Total 48hrs and 20Hz ~ 20KHz resonant frequency
Abnormal Sound Test		Must be normal tested at 6.3 Volt sine wave
Ingress Rating		IP65

Dimensions

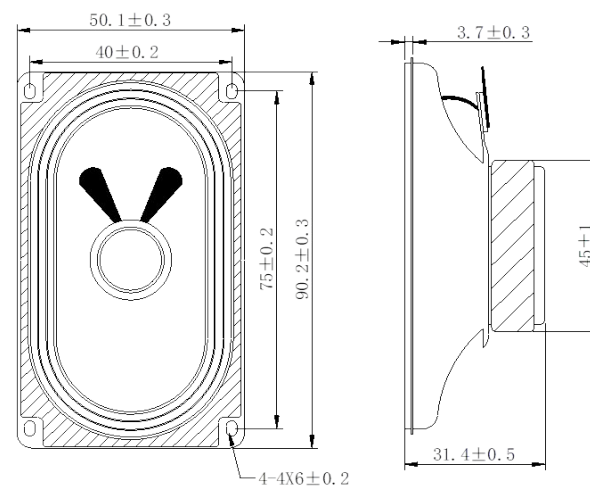

Unit: mm

Frequency Response

