

ILLUMINANT 北極光企業有限公司

PRODUCT SPECIFICATION FOR LCM

CUSTOMER:	
MODEL NO:	I3002-7IXN2440A
ACCEPTED BY:	

APPROVED BY:	CHECKED BY:	ORGANIZED BY:
		

- Approval for Specifications Only**
 Approval for Specifications and Sample

- Note: 1. Version of Specifications : 1**
2. Others: Rohs Compliment

TAIWAN

1F, #15, LANE 75, MIN CHUAN E. RD., SEC 3, TAIPEI, TAIWAN.

Tel +886-2-25175115 Fax +886-2-25175099

CHINA

5F DONGWU COMMERICAL BLDG, LANSHAN RD., NORTH DISTRICT, HI-TECH INDUSTRIAL PARK, SHENZHEN, PRC.

TEL + 86-755-86154466 FAX +86-755-86154366

KOREA

RM 1201, IT MIRAE TOWER, 60-21, GASAN-DONG, GEUMCHEON-GU, SEOUL, 153-801, KOREA

TEL + 82-2-2027-5391~2 FAX +82-2-2027-5393

ILLUMINANT

Version	Date	Contents
1	08/10/27	Initial Release

CONTENTS

- 1. Mechanical Specification**
- 2. Absolute Maximum Ratings**
- 3. Electrical Characteristics**
- 4. Block Diagram**
- 5. Optical Characteristics**
- 6. Interface**
- 7. Timing Characteristics**
- 8. Backlight**
- 9. Reliability**
- 10. Inspection Criteria**

1. Mechanical Specification

Item	Standard Value	Unit
Display Size	3.0	inch
Module Dimension	45.04(W)*77.0(H)*2.65(D)	mm
Active Area	38.88(W)*64.8(H)	mm
Number of Dots	240RGB*400Dots	Dot
Pixel Arrangement	RGB Stripe type	-
Pixel Pitch	0.162(W)mm*0.162(H)mm	mm
LCD Type	Normal White / Transmissive type	-
Viewing Direction	12H	-
Approx. Weight	TBD	g
Driver IC	ILI9326	-
Interface	MCU 80-system 8/9/16/18bit	
Color	65K/262K	
Backlight Color	White	

2. Absolute Maximum Ratings

Item	Symbol	Min.	Typ.	Max.	Unit	Remark
Supply Voltage for Logic	V _{DD}	+2.5		+3.3	V	
Operating Temperature	T _{OP}	-20	-	+70	°C	-
Storage Temperature	T _{ST}	-30	-	+80	°C	-

*NOTE: Based on V_{SS}=0V.

3. Electrical Characteristics

Item	Symbol	Condition	Min.	Typ.	Max.	Unit
Supply Voltage for Logic	V _{CC}	T _a =25°C	2.5	2.8	3.3	V
High-Level Input Voltage	V _{IHC}	V _{CC} =3.3V	0.8V _{DD}		V _{DD}	
Low-Level Input Voltage	V _{ILC}	V _{CC} =3.3V	-0.3		0.2V _{DD}	

ILLUMINANT

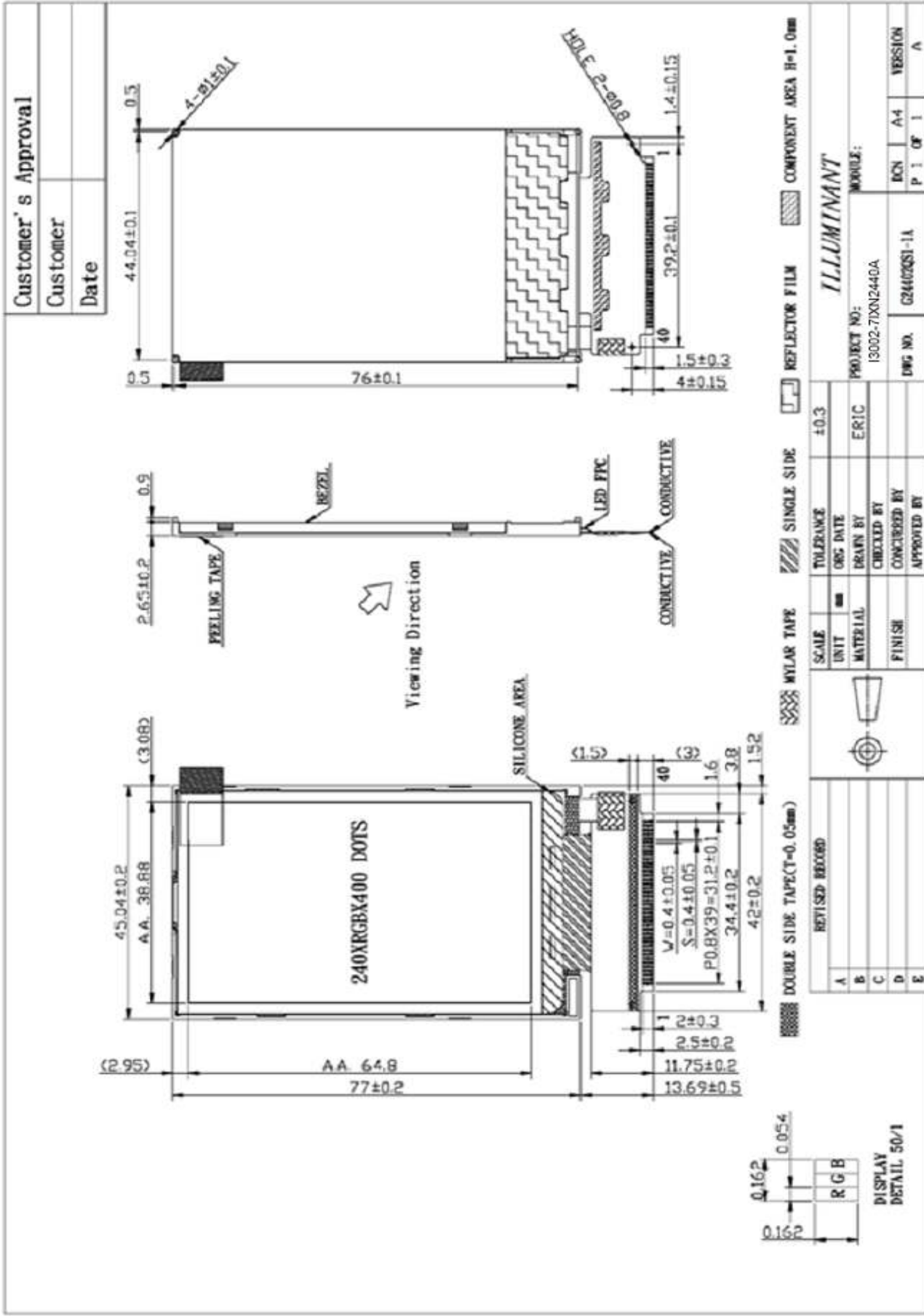

4. Block Diagram

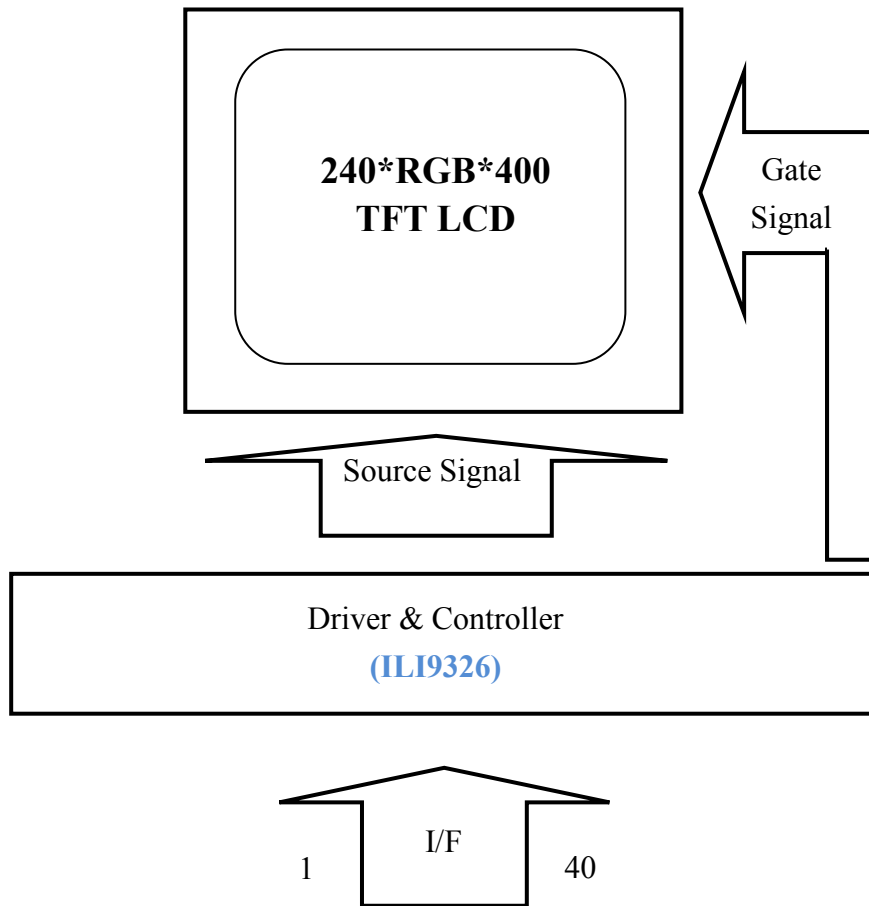

5. Optical Characteristics

LED Backlight Transmissive Module :

Item	Symbol	Temp.	Min.	Typ.	Max.	Unit	Conditions
Response Time	Tr	25°C	-	10	20	ms	$\theta=0^\circ, \Phi=0^\circ$
	Tf	25°C	-	20	30	ms	(Note 2)
Contrast Ratio	CR	25°C	-	450	-	-	$\theta=0^\circ, \Phi=0^\circ$ LED:ON,LIGHT:OFF (Note 3)
Visual Angle Range Front and Rear	θ	25°C	(θ Upper) 65 (θ Lower) 55			Degree	Note 2
Visual Angle Range Left and Right	Φ	25°C	(Φ Right) 65 (Φ Left) 65			Degree	Note 2
Visual Angle Direction Priority			12"				(Note 4)
Brightness				300	-	Cd/m ²	I _{led} =80mA Full white pattern

Parameter	Symbol	Min.	Typ.	Max.	Units	Note	
CIE color Coordinates	White	Wx	0.26	0.31	0.36	-	BM5; 2" angle
		Wy	0.25	0.30	0.35		
	Red	Rx	0.59	0.64	0.69		
		Ry	0.29	0.34	0.39		
	Green	Gx	0.33	0.38	0.43		
		Gy	0.50	0.55	0.60		
	Blue	Bx	0.09	0.14	0.19		
		By	0.03	0.08	0.13		

Note 1 : Response Time Definition

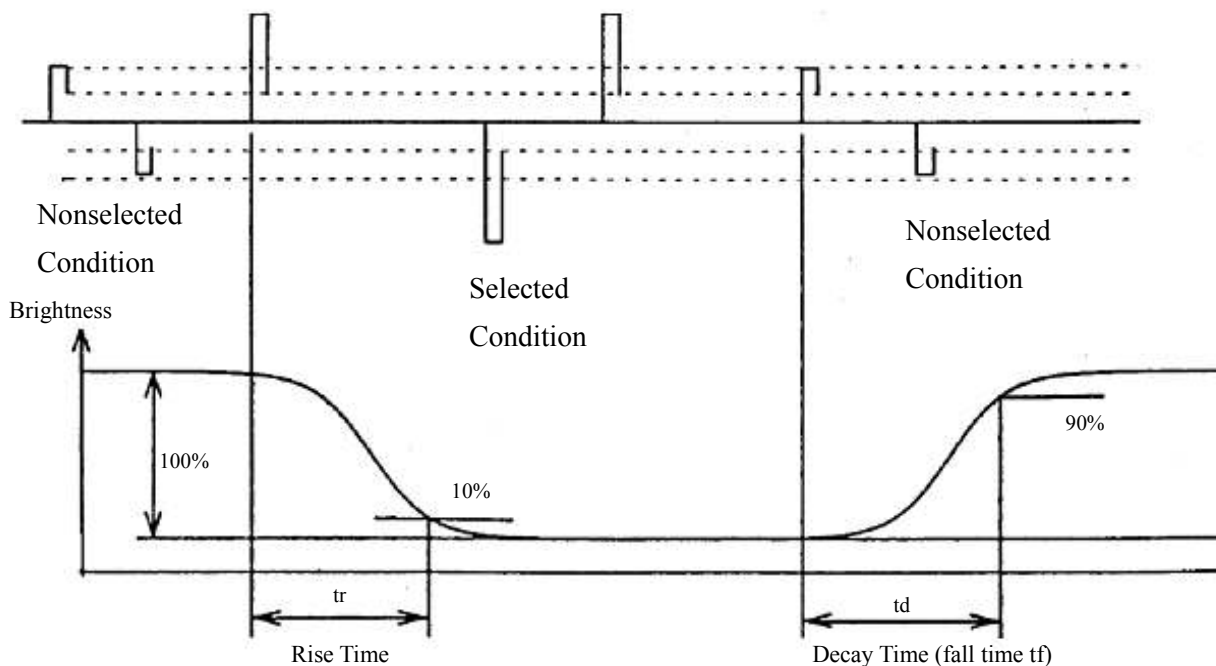

Note 2 : $\Phi \cdot \theta$ Definition

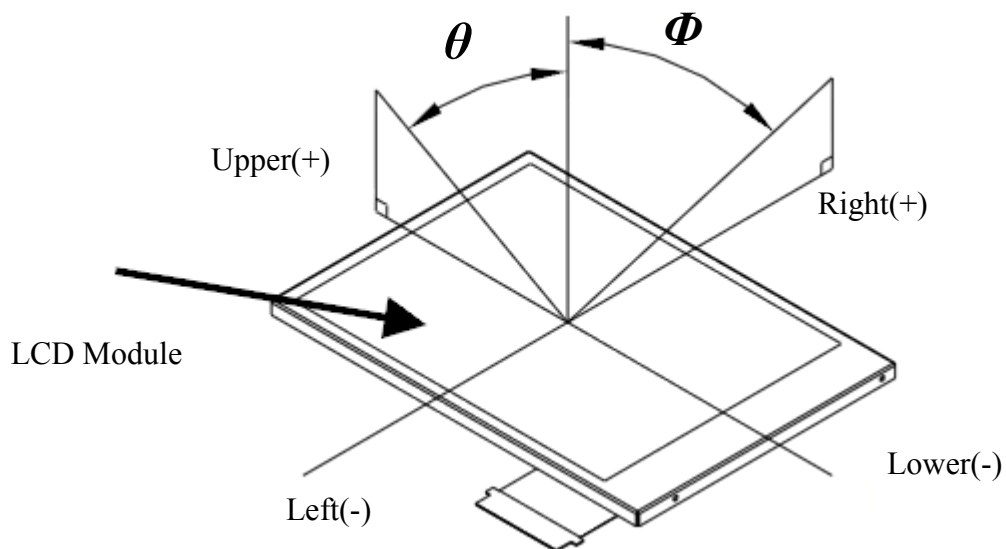

ILLUMINANT

Note 3 : Contrast Definition

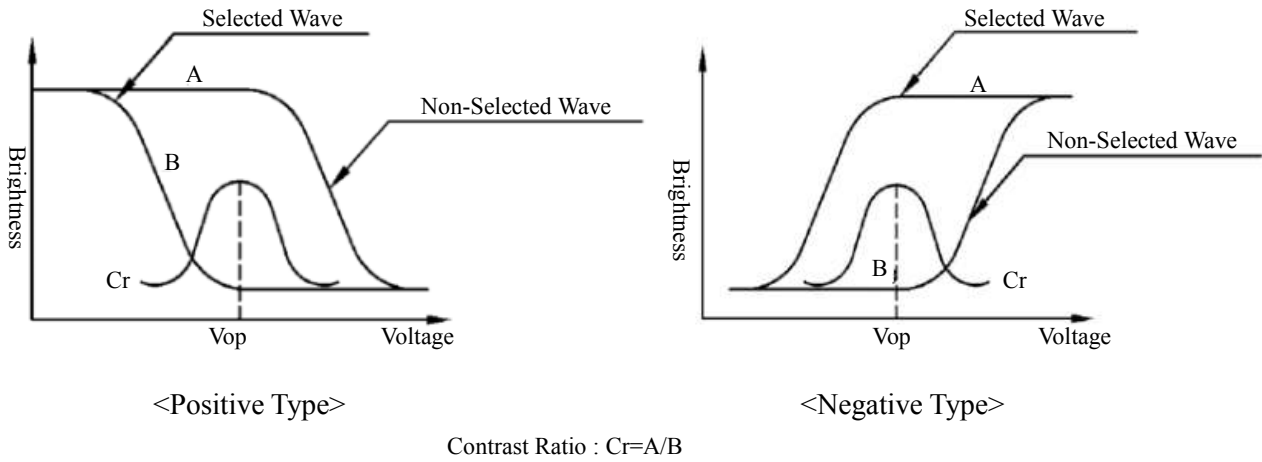

Note 4 : Visual Angle Direction Priority

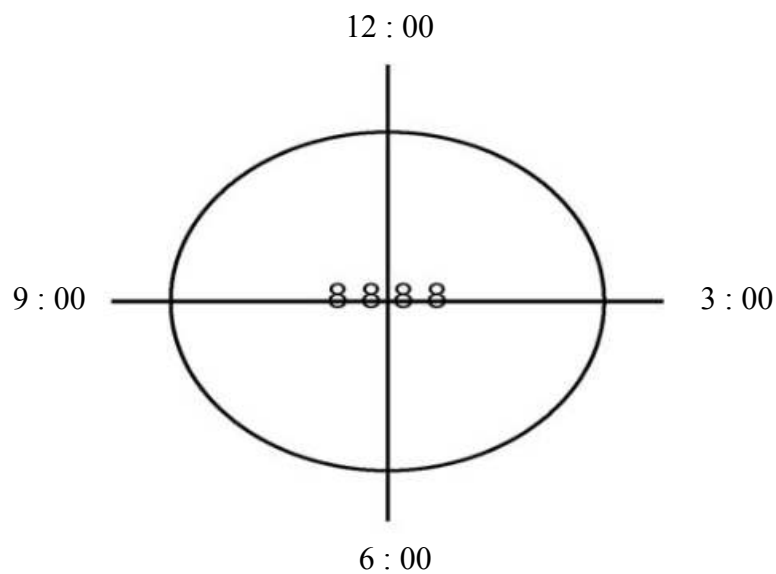

6. Interface

No	Pin Name	Function	
1	NC	Not Connect	
2	NC	Not Connect	
3	NC	Not Connect	
4	NC	Not Connect	
5	GND	Power Ground	
6	VCC	Power Input (+2.8V)	
7	VCC	Power Input (+2.8V)	
8	FMARK	FMARK Signal Pin	
9	CS	Chip Select Input Pin	
10	RS	Register Select Input Pin	
11	WR	Chip Select Input Pin	
12	RD	Read Data Select Input Pin	
13	DB0	IM1/IM0 : 1/1 8 bit I/F : DB17~10	
14	DB1		
15	DB2		
16	DB3		
17	DB4		
18	DB5		IM1/IM0 : 0/1 9 bit I/F : DB17~9
19	DB6		
20	DB7		
21	DB8		IM1/IM0 : 1/0 16 bit I/F : DB17~10 and DB8~1
22	DB9		
23	DB10	IM1/IM0 : 0/0 18 bit I/F : DB17~0 Note : Unused pins must be fixed GND level	
24	DB11		
25	DB12		
26	DB13		
27	DB14		
28	DB15		
29	DB16		
30	DB17		
31	IM1	MPU-Interface Mode Select	
32	IM0		
33	NC	Not Connect	
34	RESET	Reset Select Input Pin	
35	GND	Power Ground	
36	A	B/L Power Input Pin Anode	
37	K1	B/L Power Input Pin Negative	
38	K2	B/L Power Input Pin Negative	
39	K3	B/L Power Input Pin Negative	
40	K4	B/L Power Input Pin Negative	

7. Timing Characteristic

i80 18/16-bit System Bus Interface Timing

(a) Write to Register

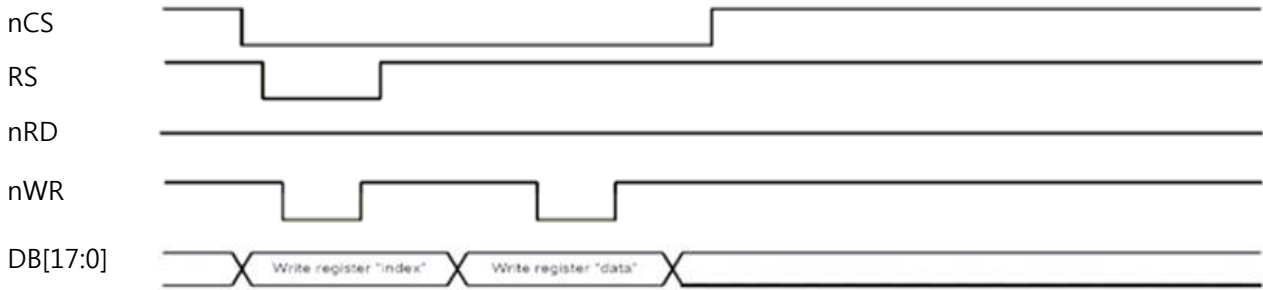

(b) Read from Register



i80 9/8-bit System Bus Interface Timing

(a) Write to Register

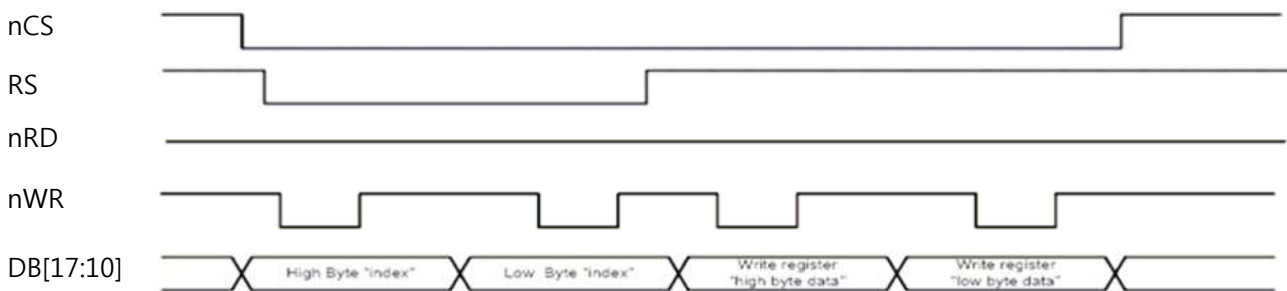

(b) Read from Register

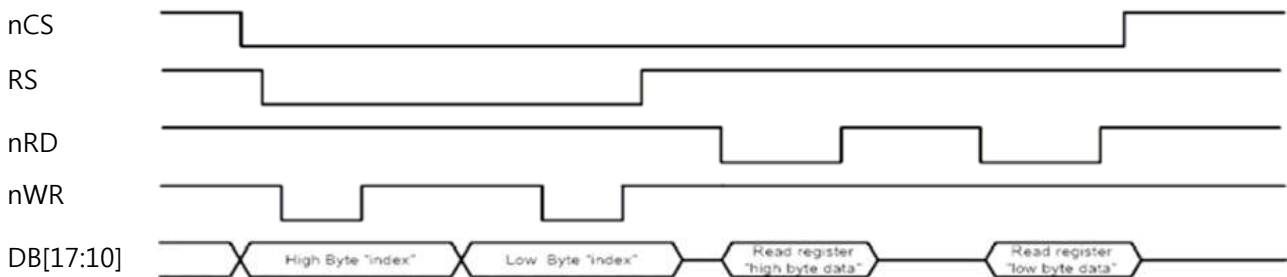

ILLUMINANT

Item	Symbol	Unit	Min.	Typ.	Max.	Test Condition
Bus cycle time	Write	t_{CYCW}	ns	100	-	-
	Read	t_{CYCR}	ns	300	-	-
Write low-level pulse width	PW_{LW}	ns	50	-	500	-
Write high-level pulse width	PW_{HW}	ns	50	-	-	-
Read low-level pulse width	PW_{LR}	ns	150	-	-	-
Read high-level pulse width	PW_{HR}	ns	150	-	-	-
Write / Read rise / Fall time	t_{WRr}/t_{WRf}	ns	-	-	25	
Setup time	Write (RS to nCS, E/nWR)	t_{AS}	ns	10	-	-
	Read (RS to nCS, RW/nRD)			5	-	-
Address hold time	t_{AH}	ns	5	-	-	
Write data set up time	t_{DSW}	ns	10	-	-	
Write data hold time	t_H	ns	15	-	-	
Read data delay time	t_{DDR}	ns	-	-	100	
Read data hold time	t_{DHR}	ns	5	-	-	

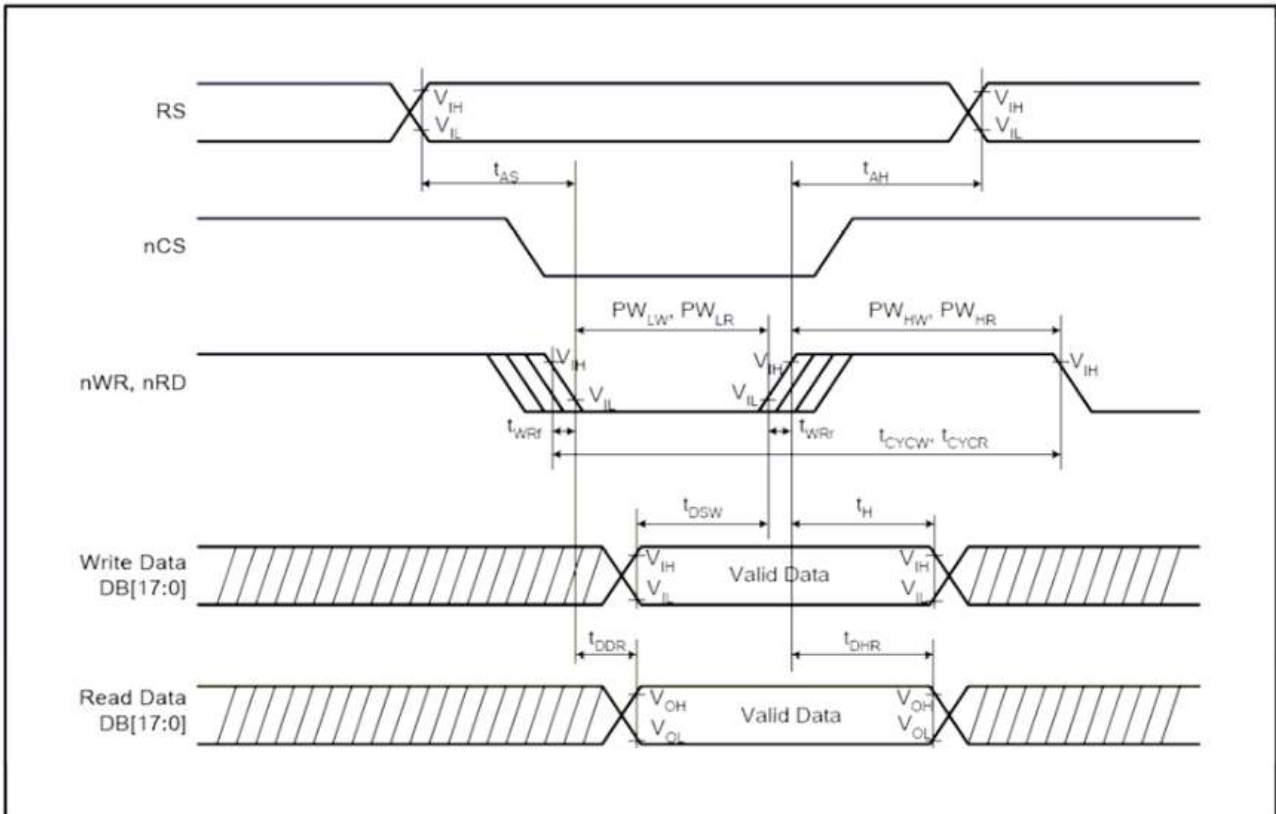

8. Backlight

8.1 Standard Lamp Styles (Edge Lighting Type):

The LED chips are distributed over the edge light area of the illumination unit, which gives the less power consumption:

8.2 The Main Advantages of the LED Backlight are as Following:

The brightness of the backlight can simply be adjusted. By a resistor or a potentiometer.

8.3 Data About LED Backlight:

Item	Symbol	Conditions	Min.	Typ.	Max.	Unit
Forward voltage	Vf	If=80	-	3.3	3.5	V
Forward current	If		-	80	-	mA
Uniformity	-	If=80	80%	-	-	-
Luminous color	-	White				
Chip connection	-	4-LED Parallels connection				

NOTE:

- 1.Backlight Only Average Luminous Intensity of P1-P9
- 2.Uniformity = $\frac{\text{Min}(P1\sim P9)}{\text{Max}(P1\sim P9)} * 100\% > 80\%$

8.4 Measured Method:

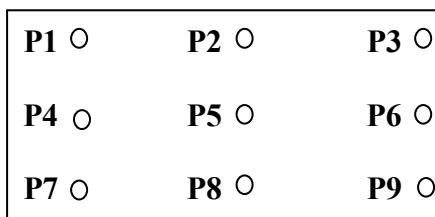

(Effective spatial Distribution)

Hole Diameter $\pm 1\phi$; 1 to 9per Position Measured Luminous

9. Reliability

9.1 MTTF

The LCD module shall be designed to meet a minimum MTTF value of 50,000 hours with normal condition. (25°C in the room without sunlight; not include lifetime of backlight and Touch Panel).

9.2 Tests

No.	Item	Condition	Criterion
1	High Temperature Operating	+70°C 240hrs	。 No defect of operational function in room temperature are allowable(23±5°C). 。 Leakage current should be below double of initial value.
2	Low Temperature Operating	-20°C 240hrs	
3	High Temperature Non-Operating	+80°C 240hrs	
4	Low Temperature Non-Operating	-30°C 240hrs	
5	High Temperature / Humidity Non-Operating	60°C ; 90%RH ; 240hrs	
6	Temperature Shock Operating	-20°C ↔ 70°C (30min) (5min) (30min) 50 Cycles	
7	Electro-Static Discharge	HBM : ±2kv	

Note 1: Test after 24 hours in room temperature(23±5°C).

Note 2: The sampling above is individually for each reliability testing condition.

Note 3: The color fading of polarizing filter should not care.

Note 4: All of the reliability testing chamber above, is using D.I. water.(Min value:1.0 MΩ-cm)

Note 5: In case of malfunction defect caused by ESD damage, if it would be recovered to normal state after resetting, it would be judged as a good part.

10. Inspection Criteria

10.1 Inspection Conditions

10.1.1 Environmental Conditions

The environmental conditions for inspection shall be as follows

Room Temperature : $23\pm 5^{\circ}\text{C}$

Humidity : $50\pm 20\% \text{RH}$

10.1.2 The External Visual Inspection

With 1000 ± 200 lux fluorescent lamp as the light source, the inspection was in the distance of 30cm or more from the LCD to the inspector's eyes .

10.2 Light Method

1. Inspection is implemented over 30cm vertical distance and 30° incidence under 1000 ± 200 lux.
(As showed below)
2. Viewing direction for inspection over 30cm far and is 45° against from LCD
(As showed below)

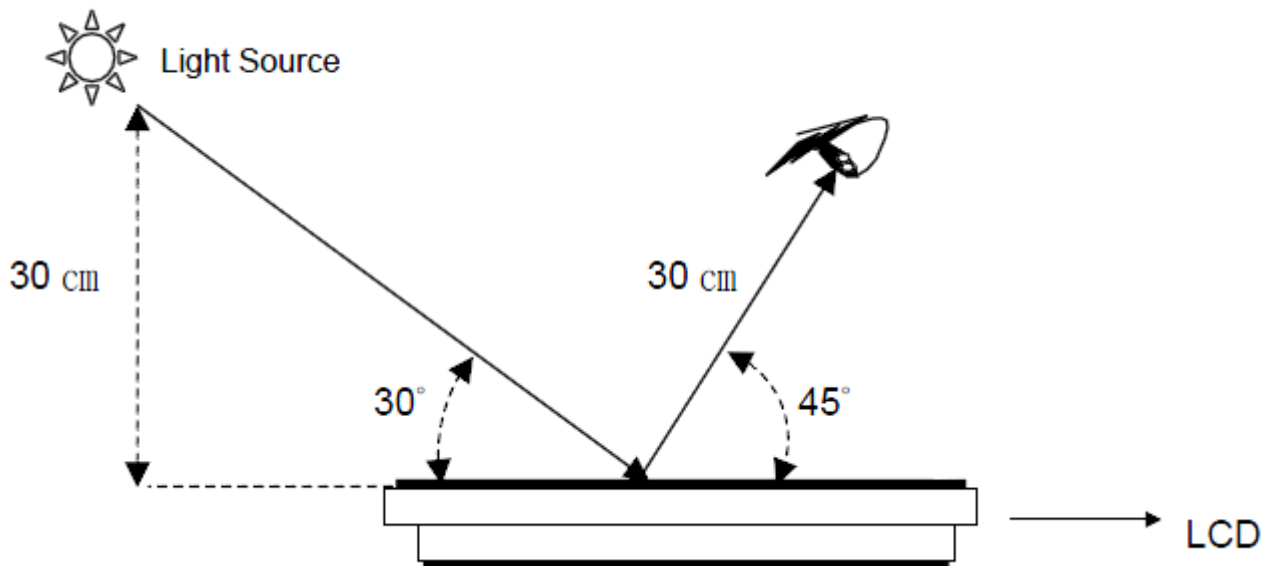

10.3 Classification of Defects

10.3.1 Major Defect

A major defect refers to a defect that may substantially degrade usability for product applications.

ILLUMINANT

10.3.2 Minor Defect

A minor defect refers to a defect which is not considered to be able substantially degrade the product application or a defect that deviates from existing standards almost unrelated to the effective use of the product or its operation.

Notes: If the LCD/LCM's cosmetic and display performance do not specify in "inspection criterion", it should be based on these delivered samples.

10.4 Sampling & Acceptable Quality Level

Inspection Item	Major Defect	Minor Defect
Cosmetic	1.0%	1.5%
Electrical Test	0.4%	0.65%

10.5 Definition of Inspection Area

V/A : Viewing Area

A/A : Active Area

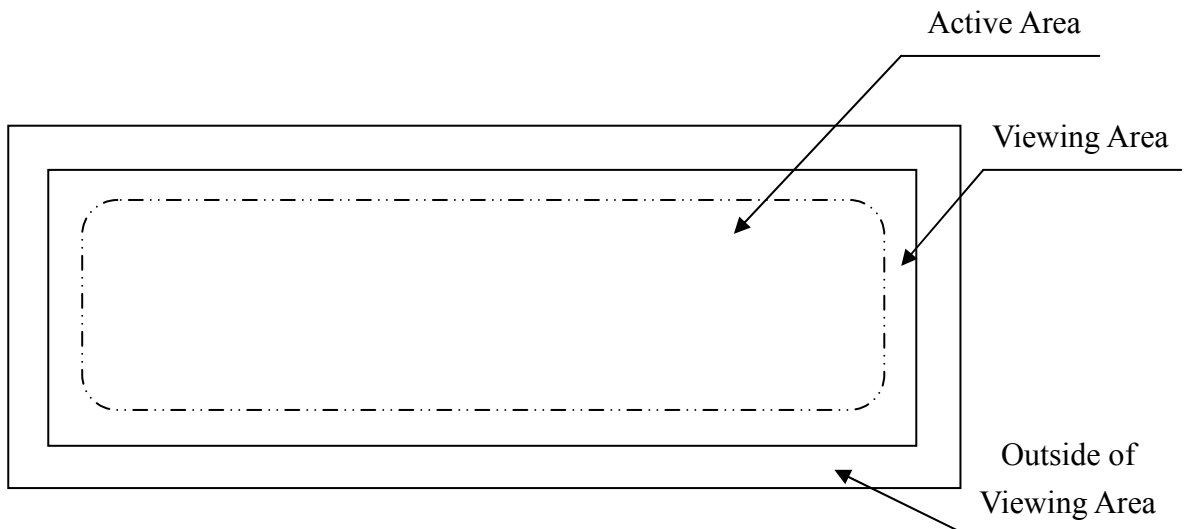

10.6 Items and Criteria

10.6.1 Visual Inspection Criterion in Cosmetic

(1) Glass Defect

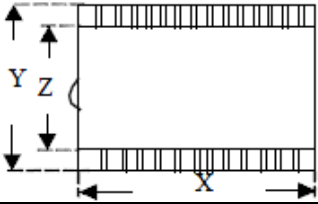
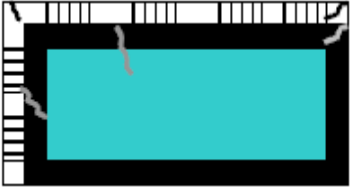
Glass Defect			
No	Defect	Criteria	Remark
1	Dimension (Minor)	By engineering diagram	
2	Cracks (Major)	Extensive crack [Reject]	

(2) LCM Appearance Defect

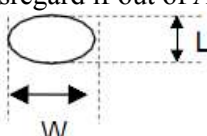
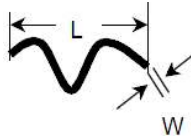
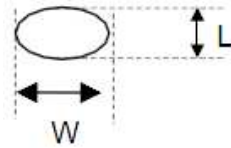
No	Defect	Criteria	Permissible Q'ty	Remark
1	Round Type (Minor)	Spec.	Permissible Q'ty	1. $\Phi = (L+W)/2$, L: Length, W: Width 2. Disregard if out of A.A. 
		$\Phi \leq 0.10\text{mm}$	Disregard	
		$0.10\text{mm} < \Phi \leq 0.20\text{mm}$	3	
		$0.20\text{mm} < \Phi$	0	
2	Line Type (Minor)	Spec.	Permissible Q'ty	1. L: Length, W: Width 2. Disregard if out of A.A. 
		$W \leq 0.03\text{mm}$	Disregard	
		$L \leq 3.0\text{mm}$ and $0.03\text{mm} < W \leq 0.05\text{mm}$	2	
		$L \leq 3.0\text{mm}$ and $0.05\text{mm} < W \leq 0.10\text{mm}$	1	
		$W > 0.10\text{mm}$ or $L > 3.0\text{mm}$	0	
3	Polarizer Dent (Minor)	Spec.	Permissible Q'ty	1. $\Phi = (L+W)/2$, L: Length, W: Width 2. Disregard if out of A.A. 
		$\Phi \leq 0.20\text{mm}$	Disregard	
		$0.20\text{mm} < \Phi \leq 0.30\text{mm}$	2	
		$0.30\text{mm} < \Phi \leq 0.50\text{mm}$	1	
		$0.50\text{mm} < \Phi$	0	

ILLUMINANT

(3) FPC

No	Defect	Criteria	Remark
1	Copper Peeling (Minor)	Copper Peeling [Reject]	



(4) Black Tape

No	Defect	Criteria	Remark
1	Copper Peeling (Minor)	Copper Peeling [Reject]	
2	No Black Tape (Minor)	No Black Tape [Reject]	

(5) Silicon

No	Defect	Criteria	Remark
1	Amount of Silicon (Minor)	ITO exposed [Reject]	

10.6.2 Visual Inspection Criterion in Electrical Display

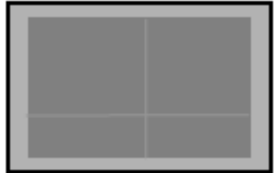
No	Defect	Criteria	Remark	
1	No Display (Major)	Not Allowed		
2	Missing Line (Major)	Not Allowed		
3	Darker or Lighter Line (Major)	Not Allowed		
4	Weak Line (Minor)	By Limited Sample		
5	Bright / Dark Point (Minor)	Spec.	1:1sub-pixel: 1R or 1G or 1B 2:Point defect area $\geq 1/2$ sub pixel.	
		Bright Point		1
		Dark Point		2

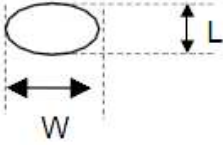
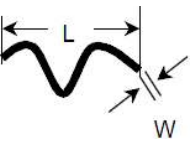
No	Defect	Criteria		Remark
6	Round Type (Minor)	Spec.	Permissible Q'ty	1. $\Phi = (L+W)/2$, L:Length, W: Width 2. Disregard if out of A.A. 
		$\Phi \leq 0.10\text{mm}$	Disregard	
		$0.10\text{mm} < \Phi \leq 0.20\text{mm}$	3	
		$0.20\text{mm} < \Phi$	0	
7	Line Type (Minor)	Spec.	Permissible Q'ty	1. L: Length, W: Width 2. Disregard if out of A.A. 
		$W \leq 0.03\text{mm}$	Disregard	
		$L \leq 3.0\text{mm}$ and $0.03\text{mm} < W \leq 0.05\text{mm}$	2	
		$L \leq 3.0\text{mm}$ and $0.05\text{mm} < W \leq 0.10\text{mm}$	1	
		$W > 0.10\text{mm}$ or $L > 3.0\text{mm}$	0	
8	Mura (Minor)	By 5% ND filter invisible		

10.6.3 Others

- Issues that are not defined in this document shall be discussed and agreed with both parties.
(customer and supplier)
- Unless otherwise agreed upon in writing, the criteria shall be applied to both parties.
(customer and supplier)