

TO-220 Plastic-Encapsulate Diodes

Schottky Rectifier

Features

- I_o 20A
- V_{RRM} 100V
- High surge current capability
- Low V_f

Applications

- Rectifier

Marking

- MBR20100L(F)CT

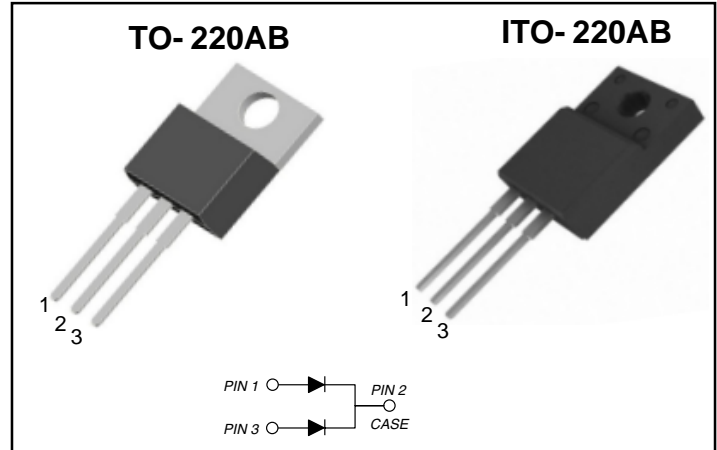

Limiting Values (Absolute Maximum Rating)

Item	Symbol	Unit	Test Conditions	MBR20100L(F)CT
Repetitive Peak Reverse Voltage	V_{RRM}	V		100
Average Rectified Output Current	I_o	A	60HZ Half-sine wave, Resistance load, T_c (Fig.1)	20.0
Surge(Non-repetitive)Forward Current	I_{FSM}	A	60Hz Half-sine wave , 1 cycle , $T_a = 25^\circ\text{C}$	150
Junction Temperature	T_J	$^\circ\text{C}$		-55~+150
Storage Temperature	T_{STG}	$^\circ\text{C}$		-55 ~ +150

Electrical Characteristics ($T_a = 25^\circ\text{C}$ Unless otherwise specified)

Item	Symbol	Unit	Test Condition	MBR20100L(F)CT	
Peak Forward Voltage	V_F	V	$I_F = 10.0\text{A}$	0.78(TYP) 0.83(MAX)	
Peak Reverse Current	I_{RRM1}	mA	$V_{RM} = V_{RRM}$	$T_a = 25^\circ\text{C}$	0.1
	I_{RRM2}			$T_a = 125^\circ\text{C}$	2.5
Thermal Resistance(Typical)	$R_{\theta J-C}$	$^\circ\text{C/W}$	Between junction and case	2.0 ¹⁾	

Notes:

Thermal resistance from junction to case per leg with heat-sink size of 2"×3"×0.25" AL-plate

Typical Characteristics

FIG.1: FORWARD CURRENT DERATING CURVE

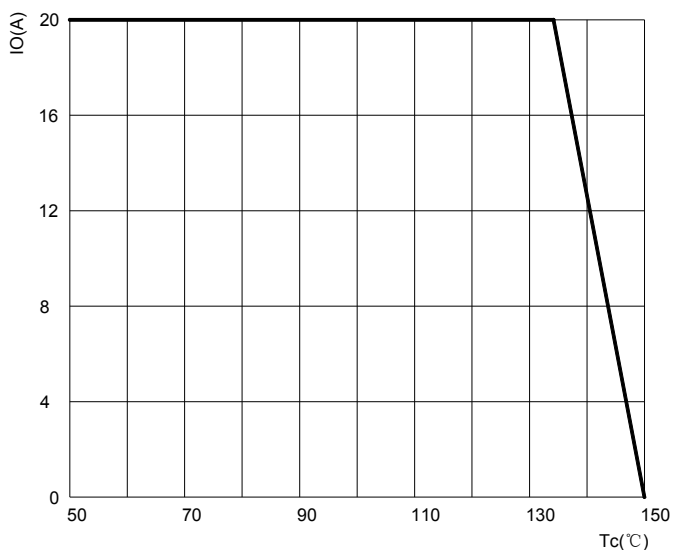

FIG.2: MAXIMUM NON-REPETITIVE FORWARD URGE CURRENT

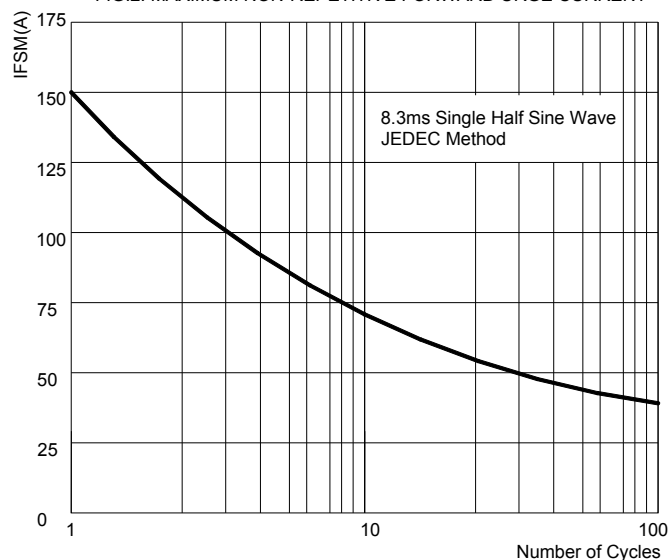

FIG3: Instantaneous Forward Voltage

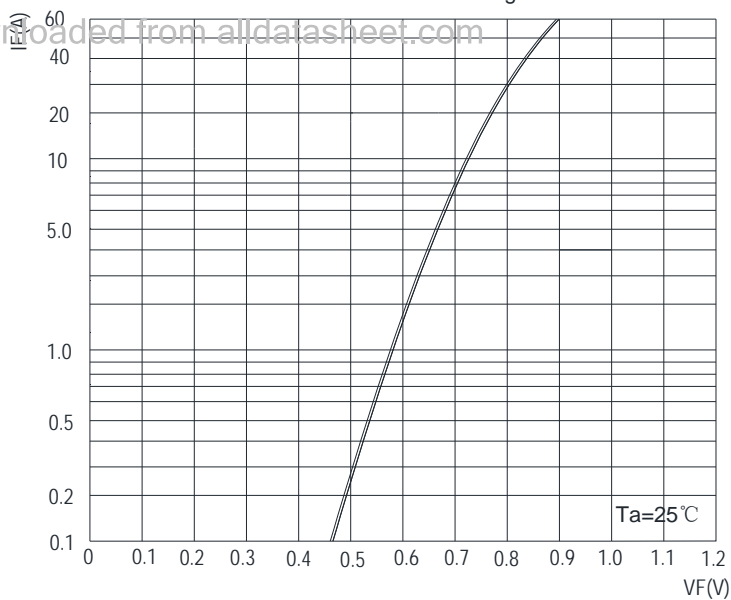
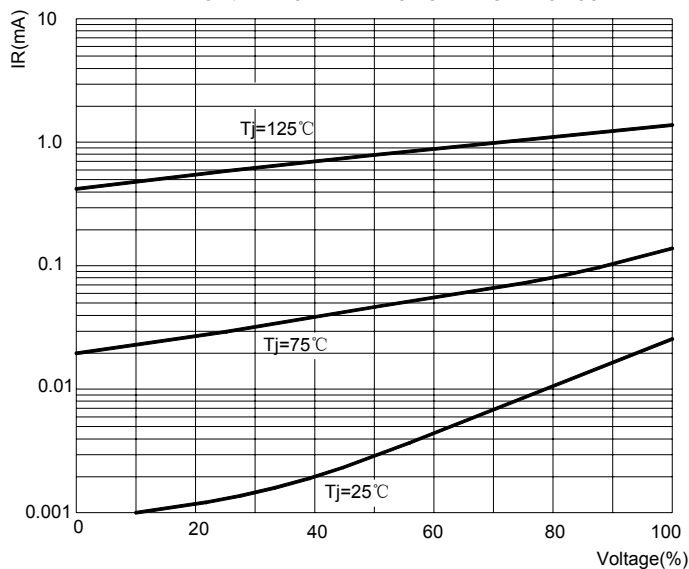
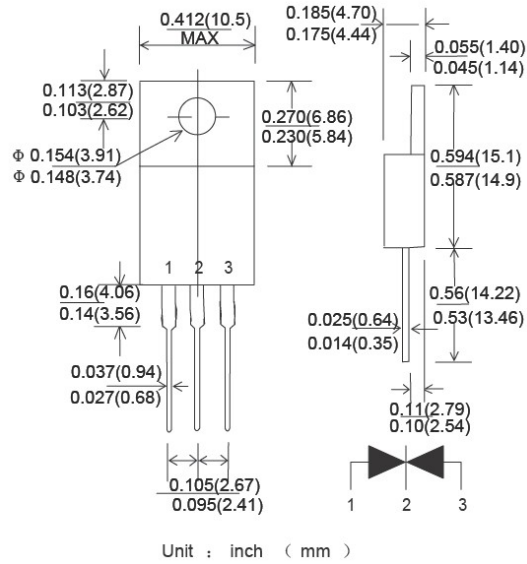

FIG.4: TYPICAL REVERSE CHARACTERISTICS



TO-220AB



ITO-220AB

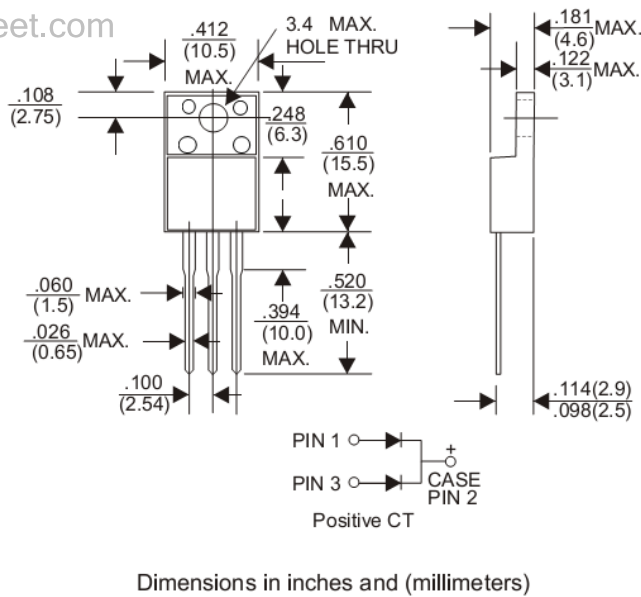

NOTICE

JSHD reserve the right to make modifications, enhancements, improvements, corrections or other changes without further notice to any product herein. JSHD does not assume any liability arising out of the application or use of any product described herein.

TO- 220 Packing Information

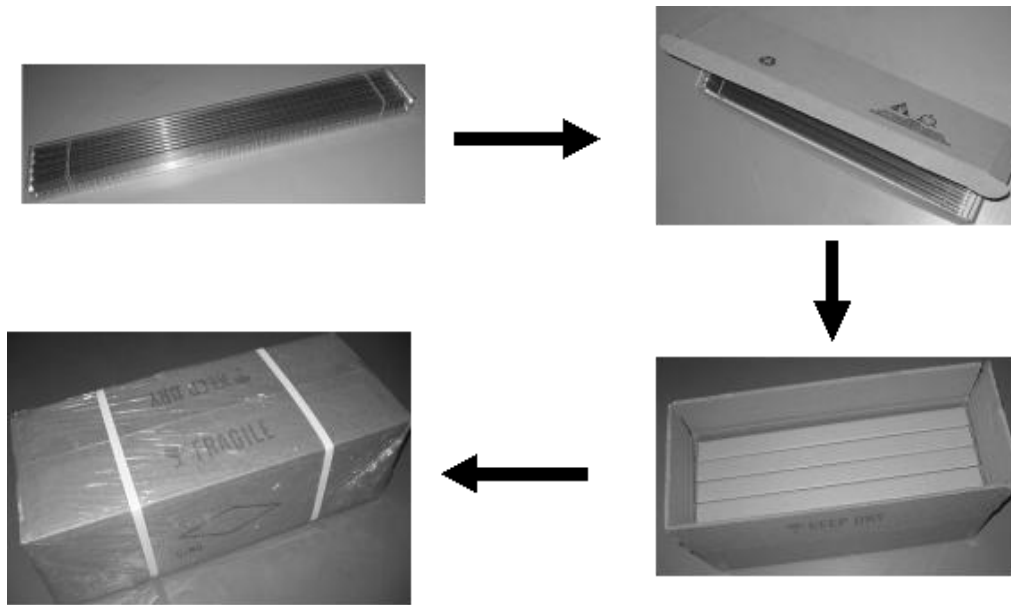

Part Number	Quantity	Size (mm)
tube	50 pieces	530*33*7
inner box	1000 pieces	558*150*40
outer container	5000 pieces	570*235*170

Downloaded from allindia.com