

KEMET, SSR10VS/HS, Commercial Grade, 4800 uH

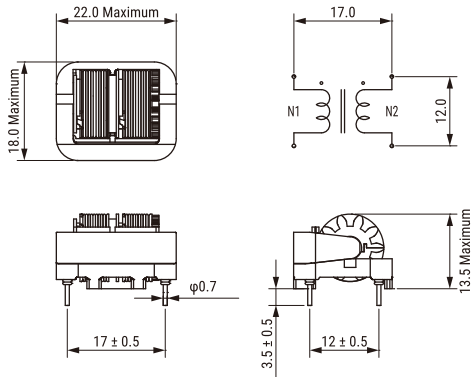

General Information	
Series:	SSR10VS/HS
Style:	Through-Hole Choke
Description:	Common Mode Choke. AC Line Filter. Wide Range Impedance Type.
Features:	Compact Size, Low Profile, Light Weight, High Frequency, Broad Bandwidth
RoHS:	Yes
Lead:	Wire Leads
Miscellaneous:	55 (K) Temperature Rise Max.

Dimensions	
L	22mm MAX
T	18mm MAX
H	13.5mm MAX
S	17mm +/-0.5mm
S1	12mm +/-0.5mm
LL	3.5mm +/-0.5mm
F	0.7mm NOM
Wire Size	0.4mm

Specifications	
Inductance:	4.8 mH (10 kHz)
Temperature Range:	-25/+120C
Rated Temperature:	120C
Current:	1.7 A
Voltage AC:	250 VAC
Withstanding Voltage:	2400 VAC MAX
Insulation Resistance:	100 MOhms

Packaging Specifications	
Weight:	9 g
Packaging:	Tray
Packaging Quantity:	300