



Engineered Metalworking Solutions

Coated Abrasives



- Fibre Discs 1–4
- Flap Discs 5–8
- Stikit™ and PSA Discs . . . 9–13
- Roloc™ Discs 14–19
- Belts 20–38
- Sheets and Rolls 39–41
- Flap Wheels 42–43
- Specialty 44–46

Surface Conditioning Abrasives



- Scotch-Brite™ Discs . . . 47–53
- Roloc™ 48–50
- Hook-and-Loop 51–52
- TN Quick Change 53
- Spindle Mount 53
- Scotch-Brite™ Belts . . . 54–56
- Scotch-Brite™ Wheels . . 57–64
- Scotch-Brite™ Specialty
Abrasives 65–66
- Scotch-Brite™
Hand Pads/Rolls 67–68

Bonded Abrasives



- Bonded Type 27 Wheels . . . 69
- Bonded Type 28 Wheels . . . 69
- Cut-Off Wheels 70

Kits and Packs



- Abrasive Kits/Packs 71

Accessories



- Abrasive Accessories . . . 72–77

Superabrasives



- Wheels 78–85
- Dressing and Truing
Tools 85–87

Abrasive Grade Guides

	P12	
	P16	
16		
	P20	

- Abrasive Grade
Comparison Guide 88
- Scotch-Brite™
Product Guide 88

Adhesives and Tapes



- Structural and Non-Structural
Adhesives 89–95
- Scotch-Weld™
Adhesives 96–97
- Tapes/Masking/
Dispensers 98–109

Safety



- Respirators 110–113
- Speedglas™ Helmets . . 114–115
- Hearing Conservation . . 116–117
- Protective Eyewear 118
- Sorbents 119
- Fall Protection 120–121
- SAFETY WARNINGS** 122

Maintenance and Repair



- Maintenance Aerosols . . . 123
- Electrical 123
- Facility Care 124
- Utility Cloth Rolls 124

Filtration



- 3M™ Purification Series
NB Liquid Bag Filters . . . 125

What's New for 2011

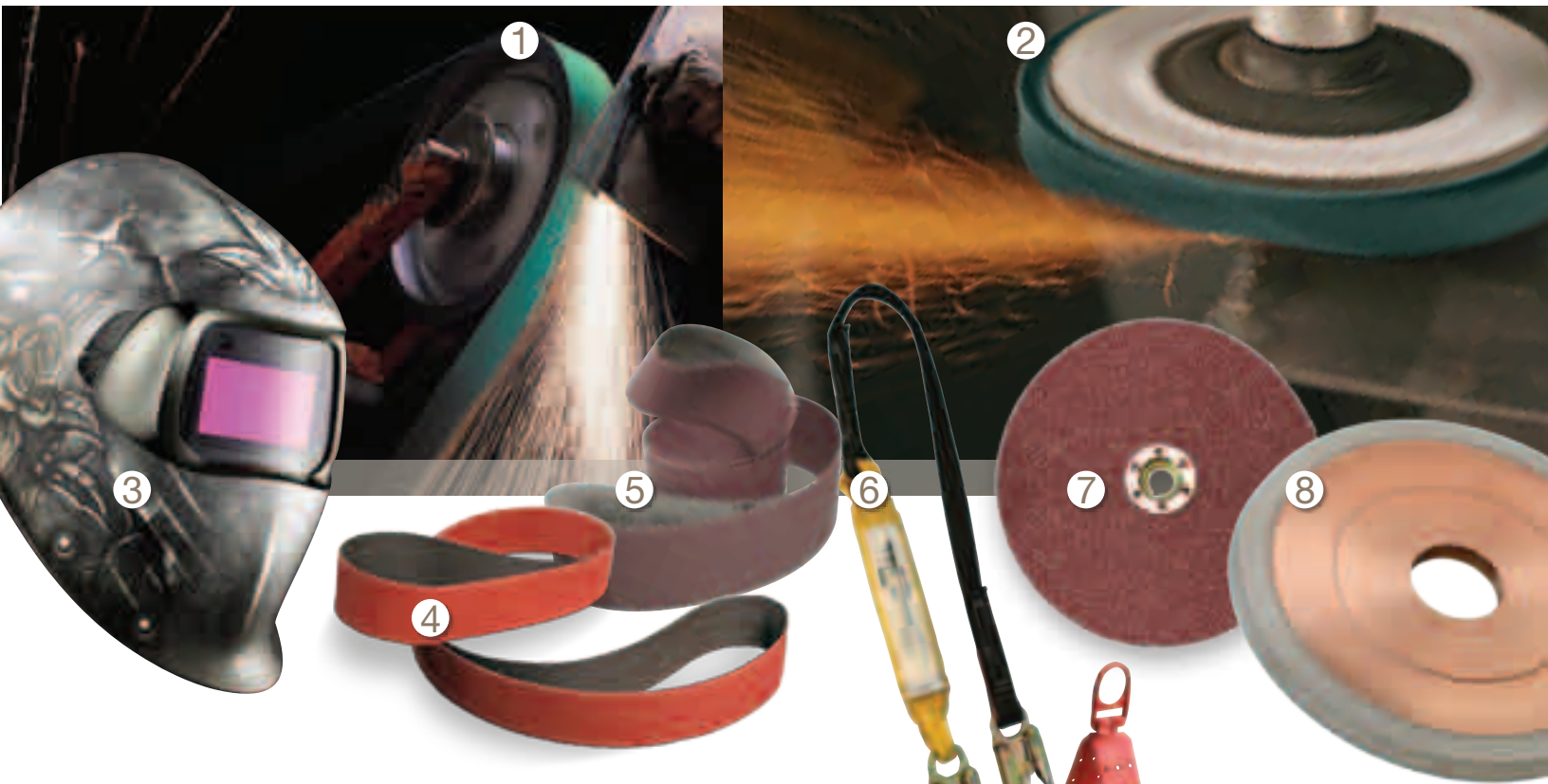

- 1 3M™ AZ Belt 577F** Because new 3M™ AZ Belts 577F last up to 20% longer than competitive belts, you can grind more parts for about the same price you're now paying for abrasives. Its new and improved premium mineral resin system, tough durable backing, and waterproof grinding aid offers a big bang for your buck. An outstanding balance of high performance and affordability make 3M AZ Belts 577F an ideal alternative for many day-to-day grinding operations.
- 2 3M™ Flap Disc 577F** is a versatile product that delivers a fast cut, long life, and a smooth finish. Performance and price make these discs a great value and the flap design allows one disc to perform both the grinding and blending steps. Plus, the economic alumina zirconia mineral is ideal for lowering abrasive costs on both mild and stainless steel applications. For those really big jobs, try the 3M™ Giant Flap Disc 577F with 25% more thickness for aggressive cut and durability.
- 3 3M™ Speedglas™ 100 Series Welding Helmets for Women** Inspired by women welders and designed for women welders, these helmets feature uniquely feminine graphics while offering the protection and quality you expect from Speedglas 100 Series helmets.
- 4 3M™ Cubitron™ II Metalworking Belts 984F** are made with revolutionary 3M precision-shaped ceramic grain technology, engineered with ultra-sharp, fast cutting points that wear evenly, run cool, and optimize mineral breakdown to maximize belt life. Whether you are looking for faster productivity, longer life, or reduced heat on parts, Cubitron™ II metalworking belt sets the standard performance for abrasive belts.
- 5 3M™ Flexible A0 Belts 302D and 332D** are new low cost, flexible aluminum oxide belts. 302D has a flexible J weight backing for finishing highly contoured parts and 332D has a flexible X weight backing for added durability for finishing semi-contoured parts. Now, along with 341D, 3M offers a full range of backing flexibilities at an unexpected price from the brand that stands for quality.
- 6 3M™ Fall Protection Products** Count on 3M to help workers at height to get the job done safely. Reliable fall arrest equipment — harnesses, lanyards and anchoring devices — provide safety and comfort.
- 7 3M™ Cubitron™ II Fibre Discs 982C** are made with revolutionary 3M precision-shaped ceramic grain technology, engineered with ultra-sharp, fast-cutting points that wear evenly, run cool and optimize mineral breakdown to maximize disc life. 982C out performs comparable fibre discs on life, cut and cost per grind, guaranteed. Finish more parts with fewer discs regardless of grinding pressure.
- 8 3M™ Superabrasive Wheels** Do you sharpen or manufacture carbide drills, endmills, taps, reamers or other round cutting tools? Check out our selection of superabrasive wheels that are in-stock and ready to ship in 2 days!

Complete solutions. Commitment to Innovation and Quality.



Complete solutions. It's what you've come to expect from 3M, the leading supplier for metalworking industries. For over 100 years, 3M has been a proven leader, providing advanced technology and innovative solutions for increased productivity, enhanced efficiency and improved manufacturing processes.

This commitment to innovation continues with ongoing new product introductions focused on the complete metalworking experience. Today, 3M Metalworking Products encompass a broad spectrum of solution-specific products from personal safety to abrasives and high-strength adhesives. 3M presents a growing portfolio with each addition to this line of advanced solutions designed for all metalworking processes from start to finish.



3M™ Fibre Discs

Choose the performance level that fits your needs with a complete offering of 3M™ Fibre Discs. Get great performance at a great price with 3M's general purpose metalworking disc 381C. Or, set a new standard for productivity with 3M™ Cubitron™ II 982C Discs. All of 3M's fibre discs are available in a variety of sizes.

3M™ Fibre Disc Selection Guide

Select Fibre Discs for fast cutting when grinding and blending.

	Product ID	Mineral	Metal Type
Good	381C	Aluminum Oxide	Carbon Steel
	501C	Alumina Zirconia	Stainless/Aluminum
Better	501C	Alumina Zirconia	Carbon Steel
	785C	Ceramic Aluminum Oxide Blend	Stainless/Aluminum
Best	988C	Ceramic Abrasive Grain	Carbon Steel
	985C	Ceramic Abrasive Grain	Stainless/Aluminum
Premium	982C	Precision Shaped Ceramic	Carbon Steel
	987C	Precision Shaped Ceramic	Stainless/Aluminum

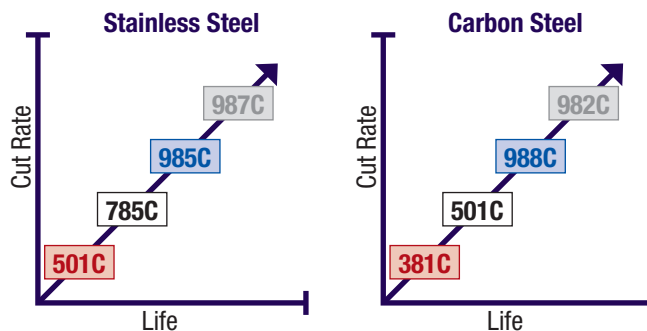

524289



3M™ Fibre Discs 381C

- General purpose disc for weld removal, grinding and blending
- Resin bond aluminum oxide provides durability and aggressive stock removal



159094

UPC	Grade	Max. RPM	Dia. x Ctr. Hole	Min./Case
051144-77595-8	24	13,300	4-1/2" x 7/8"	
051144-77596-5	36			
051144-77597-2	50			
051144-77598-9	60			
051144-77599-6	80			
051144-77600-9	100			
051144-77601-6	120	12,000	5" x 7/8"	25
051144-81369-8	24			
051144-81372-8	36			
051144-81375-9	50			
051144-01727-0	60			
051144-20054-2	80			
051144-20053-5	100	8,600	7" x 7/8"	
051144-20052-8	120			
051144-01745-4	16			
051144-81370-4	24			
051144-81373-5	36			
051144-81376-6	50			
051144-01741-6	60	6,600	9-1/8" x 7/8"	25/100
051144-01740-9	80			
051144-01739-3	100			
051144-01738-6	120			25
051144-81371-1	24			
051144-81373-5	36			
051144-81377-3	50			
051144-01762-1	80	6,600	9-1/8" x 7/8"	25
051144-01761-4†	100			
051144-01760-7†	120			

† Made-to-Order

See pages 72–77 for available accessories.

3M™ Fibre Discs (cont.)

3M™ Fibre Discs 501C

- Versatile disc for use on a wide variety of metals
- Aluminum zirconia provides a good option for both stainless and mild steel applications

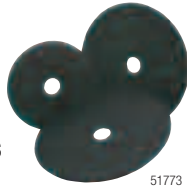

51773

UPC	Grade	Max. RPM	Dia. x Ctr. Hole	Min./Case
051111-50409-3	24	13,300	4-1/2" x 7/8"	25/100
051111-50413-0	36			
051111-50414-7	50			
051111-50415-4	60			
051111-50416-1	80			
051111-50417-8	100			
051111-50419-2	120			
051111-50410-9	24	12,000	5" x 7/8"	
051111-50412-3	36			
051111-50420-8	50			
051111-50421-5	60			
051111-50422-2	80			
051111-50423-9	100			
051111-50424-6	120			
051111-50411-6	24	8,600	7" x 7/8"	
051111-50426-0	36			
051111-50425-3	50			
051111-50427-7	60			
051111-50428-4	80			
051125-63799-2†	100			
051111-50430-7†	120			
051111-50432-1†	24	6,600	9-1/8" x 7/8"	
051111-50433-8	36			
051111-50434-5†	50			

† Made-to-Order

3M™ Fibre Discs 785C

- 3M™ Ceramic Aluminum Oxide blend abrasive grain
- An excellent starting point for stainless steel
- Includes a grinding aid for cooler running



60875

UPC	Grade	Max. RPM	Dia. x Ctr. Hole	Min./Case
051111-60719-0	36	13,300	4-1/2" x 5/8-11*	25
051144-80660-7	36	13,300	4-1/2" x 7/8"	25/100
051144-80661-4	50			
051144-80662-1	60			
051144-80663-8	80			
051144-80665-2	P120			
051144-13931-6	24			
051144-13930-9	36			
051144-13928-6	50			
051144-13977-4	60			
051144-13926-2	80			
051144-80654-6	P100			
051144-80655-3	P120	8,600	7" x 5/8-11*	
051144-88831-3†	60		7" x 7/8"	
051144-13937-8	24			
051144-13936-1	36			
051144-13934-7	50			
051144-13933-0	60			
051144-13932-3	80			
051144-80656-0	P100			
051144-80657-7	P120	6,600	9-1/8" x 7/8"	
051144-13943-9	24			
051144-13942-2	36			
051144-13940-8	50			
051144-13938-5	80			

† Made-to-Order

* Quick Change Tinneman Nut Attachment

Tech Tip

Weld Blending Mild Steel for Paint Prep

Step 1 – Fibre Disc 982C Grade 36+

Step 2 – Scotch-Brite™ Light Grinding and Blending Disc SD on black ribbed pad

Step 3 – Apply 3 mil Paint

Results – Productivity increase
– Abrasive cost improvement

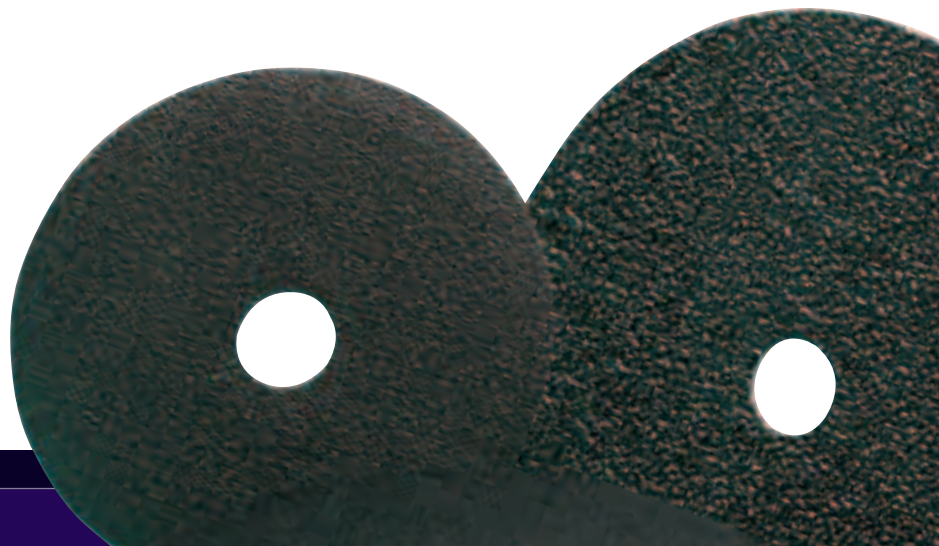

See pages 72–77 for available accessories.

3M™ Fibre Discs (cont.)

NEW! 3M™ Cubitron™ II Fibre Disc 982C

- 3M precision-shaped ceramic grain, engineered with ultra-sharp, fast cutting points that wear evenly, run cool, and optimize mineral breakdown to maximize life
- Best in class for weld prep and removal on carbon steel applications

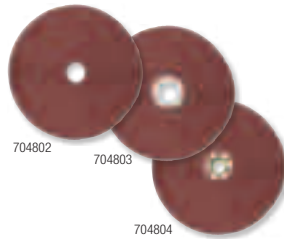

606708

UPC	Grade	Max. RPM	Dia. x Ctr. Hole	Min./Case
051141-27400-3	36+	13,300	4-1/2" x 7/8"	25/100
051141-27631-1	60+			
051141-27635-9	80+			
051141-27401-0	36+	12,000	5" x 7/8"	
051141-27632-8	60+			
051141-27636-6	80+			
051141-27402-7	36+	8,600	7" x 7/8"	
051141-27633-5	60+			
051141-27637-3	80+			
051141-27403-4	36+	6,600	9-1/8" x 7/8"	
051141-27634-2	60+			
051141-27638-0	80+			
TN Quick Change				
051141-27425-6	36+	13,300	4-1/2" x 5/8-11*	25/100
051141-27639-7	60+			
051141-27642-7	80+			
051141-27404-1	36+	12,000	5" x 5/8-11*	
051141-27640-3	60+			
051141-27643-4	80+			
051141-27405-8	36+	8,600	7" x 5/8-11*	
051141-27641-0	60+			
051141-27644-1	80+			
GL Quick Change				
051141-27406-5	36+	12,000	5" x 5/8-11*	25/100
051141-27724-0	60+			
051141-27726-4	80+			
051141-27407-2	36+	8,600	7" x 5/8-11*	
051141-27725-7	60+			
051141-27727-1	80+			

* Quick Change Tinneman Nut Attachment

3M™ Fibre Discs 985C

- 3M™ Ceramic abrasive grain
- 3M's better choice for a long-lasting, premium disc for stainless steel
- Includes a grinding aid for cooler running



UPC	Grade	Max. RPM	Dia. x Ctr. Hole	Min./Case
051111-55767-9	36	12,000	5" x 7/8"	25/100
051111-55780-8	50			
051111-55776-1	60			
051111-55779-2	80	8,600	7" x 7/8"	
051111-55971-0	24			
051111-55972-7	36			
051111-55973-4	50	8,600	7" x 7/8"	
051111-55974-1	60			
051111-55975-8	80			

Tech Tip

Use 3M™ Red Ribbed Pads to optimize product life of 900 series fibre discs—grades 24 and 36.

See pages 72–77 for available accessories.

3M™ Fibre Discs (cont.)



3M™ Cubitron™ II Fibre Disc 987C

- 3M precision-shaped ceramic grain, engineered with ultra-sharp, fast cutting points that wear evenly, run cool, and optimize mineral breakdown to maximize life
- Best in class for weld prep and removal on heat sensitive alloys such as stainless steel



UPC	Grade	Max. RPM	Dia. x Ctr. Hole	Min./Case	
051141-27447-8	36+	13,300	4-1/2" x 7/8"	25/100	
051141-27653-3	60+				
051141-27657-1	80+				
051141-27448-5	36+	12,000	5" x 7/8"		
051141-27654-0	60+				
051141-27658-8	80+				
051141-27449-2	36+	8,600	7" x 7/8"		
051141-27655-7	60+				
051141-27659-5	80+				
051141-27450-8	36+	6,600	9-1/8" x 7/8"		
051141-27656-4	60+				
051141-27660-1	80+				
TN Quick Change					
051141-27469-0	36+	13,300	4-1/2"	25/100	
051141-27661-8	60+				
051141-27664-9	80+				
051141-27467-6	36+	12,000	5"		
051141-27662-5	60+				
051141-27665-6	80+				
051141-27468-3	36+	8,600	7"		
051141-27663-2	60+				
051141-27666-3	80+				
GL Quick Change					
051141-27728-8	36+	12,000	5"		25/100
051141-27730-1	60+				
051141-27732-5	80+				
051141-27729-5	36+	8,600	7"		
051141-27731-8	60+				
051141-27733-2	80+				

3M™ Fibre Discs 988C

- 3M™ Ceramic abrasive grain
- 3M's best premium disc for long-lasting performance for mild steel grinding



UPC	Grade	Max. RPM	Dia. x Ctr. Hole	Min./Case
051111-55712-9	36	13,300	4-1/2" x 5/8-11*	25/100
051141-27341-9†	36	12,000	5" x 5/8-11*	100
051111-55746-4	24	12,000	5" x 7/8"	25/100
051111-55743-3	36			
051111-55742-6	50			
051111-60319-2	60			
051111-55740-2	80			
051111-55840-9	24	8,600	7" x 5/8-11*	
051111-55715-0	36			
051111-55964-2	24			
051111-55965-9	36			
051111-55966-6	40			
051111-55967-3	50			
051111-55739-6	60			
051111-55968-0	80			
051111-60314-7	24	6,600	9-1/8" x 7/8"	50/100
051111-55744-0	24			
051111-55735-8	36			
051111-55733-4	50			25/100

† Made-to-Order

* Quick Change Tinneman Nut Attachment

See pages 72–77 for available accessories.

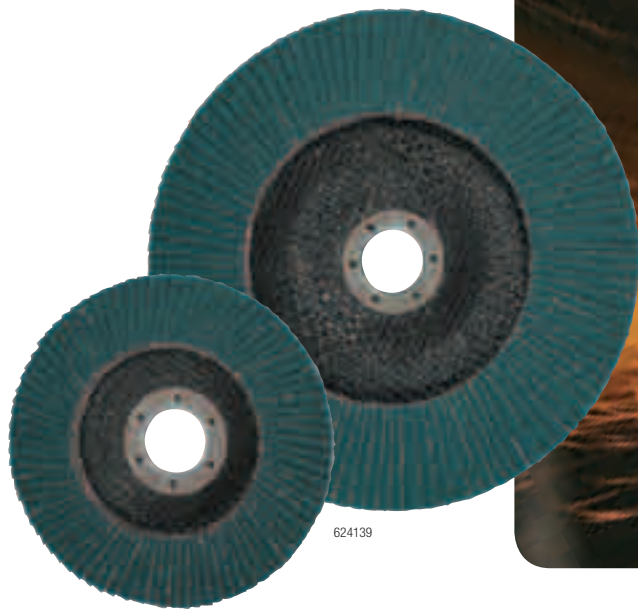

624139



631570

3M™ Flap Discs

3M™ Flap Discs offer an unbeatable system for grinding and blending in one easy step. The construction wears away, exposing fresh mineral to extend disc life and provide consistent cut rates. Great for weld grinding, blending, deburring, rust removal, surface prep and edge grinding on all types of metals. Available in both T29 or T27 constructions with or without the 5/8–11 hub.



Type 29

227097



Type 27

227096

3M™ Flap Disc Selection Guide

Select Flap Discs for extended life and single-step grinding/blending on all types of metals.

	Product ID	Mineral	4-1/2" x 7/8"		4-1/2" x 5/8-11		7" x 7/8"		7" x 5/8-11	
			T27	T29	T27	T29	T27	T29	T27	T29
Good	546D	Alumina Zirconia	●	●	●	●	●	●	●	●
	577F	Alumina Zirconia	●	●	●	●	●	●	●	●
Better	747D	Ceramic Aluminum Oxide Blend	●		●		●			
Best	947D	Ceramic Abrasive Grain	●	●	●		●	●	●	

See pages 72–77 for available accessories.

3M™ Flap Discs (cont.)

NEW! 3M™ Flap Discs 546D

- Versatile alumina zirconia mineral works on a variety of metals and applications
- Flexible X wt. cotton backing designed for fast cut on light duty grinding/finishing applications

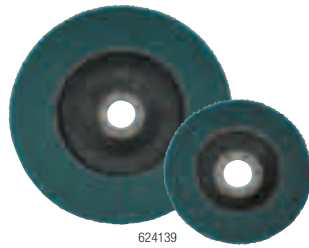

624139

UPC	Grade	Max. RPM	Dia. x Ctr. Hole	Qty./Case		
Type 29						
051115-28874-6†	24	13,300	4-1/2" x 7/8"	10		
051115-28875-3†	36					
051115-28876-0	40					
051115-28877-7	60					
051115-28878-4	80					
051115-28879-1†	120					
051115-28868-5†	24				4-1/2" x 5/8-11*	
051115-28869-2†	36					
051115-28870-8	40					
051115-28871-5	60					
051115-28872-2	80					
051115-28873-9†	120					
051115-28926-2†	24		8,600			7" x 7/8"
051115-28927-9†	36					
051115-28928-6	40					
051115-28929-3	60					
051115-28930-9	80					
051115-28931-6†	120					
051115-28920-0†	24	7" x 5/8-11*				
051115-28921-7†	36					
051115-28922-4	40					
051115-28923-1	60					
051115-28924-8	80					
051115-28925-5†	120					

† Made-to-Order
* Quick Change Hub Attachment

3M™ Flap Discs 546D (cont.)

UPC	Grade	Max. RPM	Dia. x Ctr. Hole	Qty./Case			
Type 27							
051141-30598-1†	36	13,300	4-1/2" x 7/8"	10			
051141-30599-8	40						
051141-30600-1	60						
051141-30601-8	80						
051141-30602-5†	120						
051141-30593-6†	36				4-1/2" x 5/8-11*		
051141-30594-3	40						
051141-30595-0	60						
051141-30596-7	80						
051141-30597-4†	120						
051141-30603-2†	36		8,600			7" x 7/8"	5
051141-30604-9	40						
051141-30605-6	60						
051141-30606-3	80						
051115-28917-0†	120						
051141-30607-0†	36	7" x 5/8-11*					
051141-30608-7	40						
051141-30609-4	60						
051141-30610-0	80						
051115-28919-4†	120						

† Made-to-Order
* Quick Change Hub Attachment

Tech Tip

Flap discs typically provide a finish one grade finer than they are graded.

See pages 72–77 for available accessories.

3M™ Flap Discs (cont.)

NEW! 3M™ Flap Discs 577F

- Versatile alumina zirconia mineral works on a variety of metals and applications
- Durable YF wt. polyester backing designed for long life on the most heavy duty grinding applications



NEW! 3M™ Giant Flap Discs 577F

- Versatile alumina zirconia mineral works on a variety of metals and applications
- Durable YF wt. polyester backing designed for long life on the most heavy duty grinding applications



- 25% more flaps than standard 3M™ Flap Discs 577F

UPC	Grade	Max. RPM	Dia. x Ctr. Hole	Qty./Case			
Type 29							
051141-30983-5	36	13,300	4-1/2" x 5/8-11	10			
051141-30984-2	40						
051141-30985-9	60						
051141-30986-6	80						
051141-30987-3	36						
051141-30988-0	40		4-1/2" x 7/8"				
051141-30989-7	60						
051141-30990-3	80						
051141-30991-0	36						
051141-30992-7	40						
051141-30993-4	60	8,600	7" x 5/8-11	5			
051141-30994-1	80						
051141-30995-8	36						
051141-30996-5	40						
051141-30997-2	60		7" x 7/8"				
051141-30998-9	80						
Type 27							
051141-30951-4	36				13,300	4-1/2" x 5/8-11	10
051141-30952-1	40						
051141-30953-8	60						
051141-30954-5	80						
051141-30955-2	36						
051141-30956-9	40	4-1/2" x 7/8"					
051141-30957-6	60						
051141-30958-3	80						
051141-30963-7	36		8,600	7" x 5/8-11		5	
051141-30964-4	40						
051141-30965-1	60						
051141-30966-8	80						
051141-30959-0	36	7" x 7/8"					
051141-30960-6	40						
051141-30961-3	60						
051141-30962-0	80						

UPC	Grade	Max. RPM	Dia. x Ctr. Hole	Qty./Case			
Type 29							
051141-30999-6	36	13,300	4-1/2" x 5/8-11	10			
051141-31000-8	40						
051141-31001-5	60						
051141-31002-2	80						
051141-31003-9	36						
051141-31004-6	40		4-1/2" x 7/8"				
051141-31005-3	60						
051141-31006-0	80						
051141-31011-4	36				8,600	7" x 5/8-11	5
051141-31012-1	40						
051141-31013-8	60						
051141-31014-5	80						
051141-31007-7	36	7" x 7/8"					
051141-31008-4	40						
051141-31009-1	60						
051141-31010-7	80						
Type 27							
051141-30967-5	36	13,300	4-1/2" x 5/8-11	10			
051141-30968-2	40						
051141-30969-9	60						
051141-30970-5	80						
051141-30971-2	36						
051141-30972-9	40		4-1/2" x 7/8"				
051141-30973-6	60						
051141-30974-3	80						
051141-30979-8	36				8,600	7" x 5/8-11	5
051141-30980-4	40						
051141-30981-1	60						
051141-30982-8	80						
051141-30975-0	36	7" x 7/8"					
051141-30976-7	40						
051141-30977-4	60						
051141-30978-1	80						

See pages 72-77 for available accessories.

3M™ Flap Discs (cont.)

3M™ Flap Discs 747D

- 3M™ Ceramic Aluminum Oxide blend abrasive grain provides extended cut and life on hard metals



84696

UPC	Grade	Max. RPM	Dia. x Ctr. Hole	Qty./Case
Type 27				
051111-49613-8	36	13,300	4-1/2" x 7/8"	10
051111-49614-5	50			
051111-49615-2	60			
051111-49616-9	80			
051111-49617-6	P120			
051111-55805-8	36		4-1/2" x 5/8-11*	
051111-61057-2†	50			
051111-61058-9†	60			
051111-61059-6†	80			
051111-61060-2†	P120			
051111-49608-4	36	8,600	7" x 7/8"	
051111-49609-1	50			
051111-49610-7	60			
051111-49611-4	80			
051111-49612-1†	120			

† Made-to-Order

* Quick Change Tinneman Nut Attachment

3M™ Flap Discs 947D

- Excellent option for stainless steel finishing
- 3M™ Ceramic abrasive grain for exceptional cut and life on hard metals



360834

UPC	Grade	Max. RPM	Dia. x Ctr. Hole	Qty./Case			
Type 27							
051111-61187-6	40	13,300	4-1/2" x 7/8"	10			
051111-61188-3	60						
051111-61189-0	80						
051111-61190-6	120						
051111-61191-3	40						
051111-61192-0	60		4-1/2" x 5/8-11*				
051111-61193-7	80						
051111-61194-4	120						
051111-61195-1	40				8,600	7" x 7/8"	5
051111-61196-8	60						
051111-61197-5	80						
051111-61198-2	120	7" x 5/8-11*					
051111-61199-9	40						
051111-61200-2	60						
051111-61201-9	80						

* Quick Change Hub Attachment

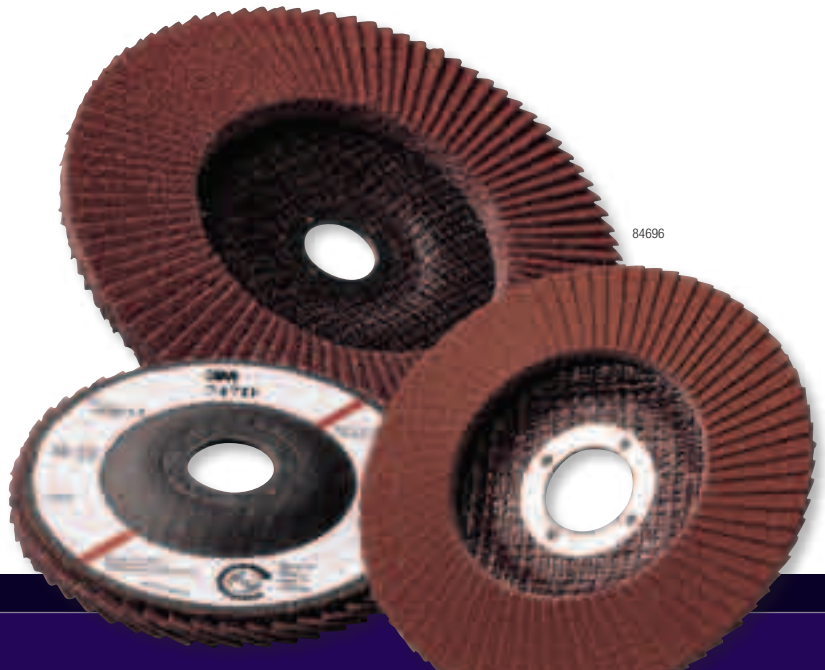

84696

See pages 72–77 for available accessories.

3M™ Stikit™ and PSA Discs

3M™ Stikit™ and PSA Discs are designed to handle a wide range of sanding and finishing needs. These discs have a pressure sensitive adhesive coating on the back side for easy application and clean removal.

3M™ Stikit™ and PSA Disc Selection Guide

	3M ID	Anti-Loading	Backing	Application		Metal Type					
				Blending	Finishing	Stainless Steel	Aluminum	Carbon Steel	Titanium	Nickel Alloy	Non-Ferrous (Brass/Bronze)
Good	NX	Yes	C & D wt. Paper	●	●	●	●	●			
	341D	—	X wt. Cloth	●	●		●	●			●
Better	236U	Yes	C wt. Paper	●	●		●	●			
	426U	Yes	A wt. Paper		●	●	●	●			
	363I	—	F wt. Paper	●	●		●	●			
	202DZ	—	J wt. Cloth	●	●		●				●
	348D	—	X wt. Cloth	●			●	●			
Best	735U	Yes	C wt. Paper	●	●		●	●			
	763U	—	F wt. Paper	●	●	●	●	●			
	777F	—	Y wt. Cloth	●	●	●		●	●	●	
	900DZ	—	J wt. Cloth	●	●		●				

3M™ Stikit™ Discs

3M™ Stikit™ Disc 202DZ

- Aluminum oxide on a durable J wt. cloth backing
- Excellent for use on aluminum and brass
- Open coat resists loading
- Individual discs with liners



148265

UPC	Grade	Diameter	Min./Case
Paper Backing			
051111-50450-5	80	5"	50/250
051111-50451-2	P100		
051111-50452-9	P120		
051111-50453-6	P150		
051111-50454-3	P180		
051111-50455-0	P220		
051111-50459-8	80	6"	
051111-50460-4	P100		
051111-50461-1	P120		
051111-50462-8	P150		
051111-50463-5†	P180		
051111-50464-2	P220		

† Made-to-Order

ATTENTION: See backup pad maximum operating speed for the appropriate operating speed for the 3M™ Stikit™ and PSA Discs.

See pages 72–77 for available accessories.

3M™ Stikit™ Discs (cont.)

NEW! 3M™ NX Disc Roll

- Aluminum oxide on a C wt. (P100–P400) or D wt. (40, P60, P80) paper backing
- Load resistant coating
- Excellent for sanding on whitewood, primer, paint sealers and topcoats

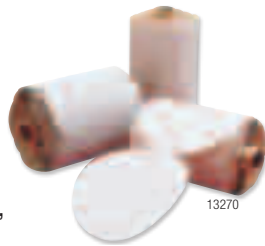

UPC	Grade	Diameter	Min./Case
Paper Backing			
051141-31181-4	P80	5" x NH	100/4
051141-31182-1	P100		
051141-31183-8	P120		
051141-31184-5	P150		
051141-31185-2	P180		
051141-31186-9	P220		
051141-27672-4	P240		
051141-27674-8	P320		
051141-27676-2	P400	6" x NH	100/4
051141-31189-0	P80		
051141-31190-6	P100		
051141-31191-3	P120		
051141-31192-0	P150		
051141-31193-7	P180		
051141-31194-4	P220		
051141-27673-1	P240		
051141-27675-5	P320	5" x NH	50/250
051141-27677-9	P400		
Paper Backing with Tabbed Liner			
051141-31211-8	40	5" x NH	
051141-31212-5	P60		
051141-31219-4	40	6" x NH	
051141-31220-0	P60		

3M™ Stikit™ Disc Roll 236U

- Aluminum oxide on a C wt. paper backing
- Discs for paint, primer, wood, metal, plastic and fiberglass
- Strong paper backing provides durability and increased cut rate
- Open coat minimizes loading
- Load resistant coating



UPC	Grade	Diameter	Discs/Roll	Qty./Case
Paper Backing				
051144-86488-1	P80	5"	100	4
051144-86489-8	P100			
051144-86490-4	P120			
051144-86491-1	P150			
051144-86492-8	P180			
051144-86493-5	P220			
051144-86494-2	P240			
051144-86495-9	P320			
051144-86496-6	P400	6"	100	4
051144-86497-3	P500			
051144-86468-3	P80			
051144-86469-0	P100			
051144-86470-6	P120			
051144-86471-3	P150			
051144-86472-0	P180			
051144-86473-7	P220			
051144-86474-4	P240	5" x NH	100	4
051144-86475-1	P320			
051144-86476-8	P400			
051144-86477-5	P500	6" X NH		

NEW! 3M™ Stikit™ Disc Roll 341D

- Aluminum oxide on a durable X wt. cloth backing
- Resin bonded for heat resistance



UPC	Grade	Diameter	Discs/Roll	Qty./Case
Paper Backing				
051144-21752-6	50	5" X NH	100	4
051144-21751-9	60			
051144-21750-2	80			
051144-21749-6	P100			
051144-21748-9	P120			
051144-21746-5	P180	6" X NH	100	4
051144-21762-5	60			
051144-21761-8	80			

See pages 72–77 for available accessories.

3M™ Stikit™ Discs (cont.)

3M™ Stikit™ Disc Roll 363I

- Aluminum oxide on an extra heavy F wt. paper backing
- Resin bonded for heat resistance



105480

UPC	Grade	Diameter	Discs/Roll	Qty./Case
Paper Backing				
051144-21800-4	60	5" x NH	100	4
051144-21799-1	80			
051144-21798-4	P100			
051144-21797-7	P120			
051144-21796-0	P150			
051144-21795-3	P180			
051144-21794-6	60	6" x NH		
051144-21793-9	80			
051144-21792-2	P100			
051144-21791-5	P120			
051144-21790-8	P150			
051144-21789-2	P180			



3M™ Stikit™ Disc Roll 426U

- Silicon carbide abrasive on a flexible A wt. paper backing
- Features a load resistant coating
- Delivers good cut and excellent finish



715682

UPC	Grade	Diameter	Discs/Roll	Qty./Case
051141-27775-2	80	5" x NH	125	10
051141-27776-9	100			
051141-27777-6	120			
051141-27778-3	150			
051141-27779-0	180			
051141-27780-6	220			
051141-27781-3	240	6" x NH	175	6
051141-27782-0	280			
051141-27783-7	320			
051141-27784-4	400			
051141-27785-1	80			
051141-27786-8	100			
051141-27787-5	120	6" x NH	125	10
051141-27788-2	150			
051141-27789-9	180			
051141-27790-5	220			
051141-27791-2	240			
051141-27792-9	320			

Tech Tip

3M™ Disc Finish and Life (comparing grade 180)

Get the most out of your 900DZ disc by pairing it with our 2-Handed 3M™ Random Orbital Sander (PN28337)



Best Finish (fewest swirl marks)

- ↑
- 426U
 - NX
 - 236U
 - 363I
 - 735U
 - 763U
 - 202DZ
 - 341D
 - 900DZ
- ↓

Coarsest Finish

Longest Life (related to mineral dulling)

- ↑
- 900DZ
 - 777F
 - 341D
 - 202DZ
 - 763U
 - 735U
 - 363I
 - 236U
 - NX
 - 426U
- ↓

Least Life

ATTENTION: See backup pad maximum operating speed for the appropriate operating speed for the 3M™ Stikit™ and PSA Discs.

See pages 72–77 for available accessories.

3M™ Stikit™ Discs (cont.)



3M™ Stikit™ Disc/ Disc Roll 735U

- 3M™ Ceramic Aluminum Oxide blend abrasive grain on a C wt. paper
- Load-resistant coating
- Sharp-cutting and durable
- Ideal for wood, soft metals, fiberglass and solid surface

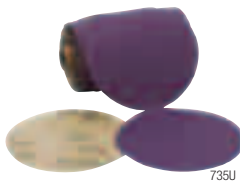

UPC	Grade	Diameter	Discs/Roll	Qty./Case
Disc Rolls				
051111-51229-6	P80	5" x NH	100	4
051111-51230-2	P100			
051111-51231-9	P120			
051111-51232-6	P150			
051111-51233-3	P180			
051111-51234-0	P220			
Paper Backing with Tabbed Liner				
051141-20760-5	P80	5" x NH	50	5
051141-20762-9	P100			
051141-20764-3	P120			
051141-20766-7	P150			
051141-20768-1	P180			
051141-20770-4	P220	6" x NH	50	5
051141-24042-8	P80			
051141-24043-5	P100			
051141-24044-2	P120			
051141-24045-9	P150			
051141-24046-6	P180			
051141-24047-3	P220			

3M™ Stikit™ Disc Roll 763U

- 3M™ Ceramic Aluminum Oxide blend abrasive grain on a heavy F wt. paper backing

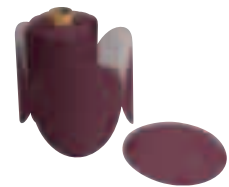

UPC	Grade	Diameter	Discs/Roll	Qty./Case
Paper Backing				
051144-80942-4	60	5" x NH	100	4
051144-80943-1	80			
051144-80944-8	P100			
051144-80945-5	P120	6" x NH	100	4
051144-80946-2	60			
051144-80947-9	80			

3M™ Stikit™ Disc 900DZ

- High performance 3M™ Ceramic abrasive grain on a J wt. backing
- Open coat to reduce loading
- Individual discs with liner



UPC	Grade	Diameter	Min./Case
Paper Backing			
051111-49639-8	80	5" x NH	50/250
051111-49640-4	P100		
051111-49641-1	P120		
051111-49643-5	P150		
051111-49642-8	P180		
051111-49644-2	P220		

ATTENTION: See backup pad maximum operating speed for the appropriate operating speed for the 3M™ Stikit™ and PSA Discs.

See pages 72–77 for available accessories.



3M™ PSA Discs

NEW! 3M™ PSA Cloth Disc 348D

- Aluminum oxide on an X wt. cloth backing
- Heavy-duty, cloth-backed discs for more aggressive applications
- Provides excellent adhesion while removing easily



UPC	Grade	Diameter	Min./Case	
Cloth Backing				
051144-20913-2	36	2"	50/200	
051144-20911-8	50			
051144-20910-1	60			
051144-20909-5	80			
051144-20908-8	P100			
051144-20907-1	P120			
051144-01335-7	40	3"		
051144-01334-0	50			
051144-01333-3	60			
051144-01332-6	80			
051144-01331-9	P100			
051144-01330-2	P120			
051144-20891-3	36	5"	50/250	
051144-20890-6	40			
051144-20889-0	50			
051144-20888-3	60			
051144-20887-6	80			
051144-20886-9	P100			
051144-20885-2	P120			
051144-20884-5	P150			
051144-20883-8	P180			
051144-20881-4	P240			
051144-21639-0	36			6"
051144-21731-1	40			
051144-20879-1	50			
051144-20878-4	60			
051144-20877-7	80			
051144-20876-0	P100			
051144-21497-6	P120	8"		
051144-20874-6	36			
051144-20873-9	40			
051144-20871-5	60			
051144-20870-8	80			
051144-20868-5	P120			
051144-88906-8	36	12"		10
051144-88905-1	40			
051144-88904-4	50			
051144-88903-7	60			
051144-88902-0	80			
051144-88901-3	P100			



3M™ PSA Cloth Disc 348D (cont.)

UPC	Grade	Diameter	Min./Case
051144-88890-0	36	16"	10
051144-88889-4	40		
051144-88887-0	60		
051144-88886-3	80	18"	
051144-88882-5	36		
051144-88880-1	60		
051144-88878-8	36	20"	
051144-88877-1	40		
051144-88876-4	50		
051144-88875-7	60		
051144-88874-0	80	24"	
051144-20802-9	36		
051144-20801-2	40		
051144-20798-5	80		

3M™ PSA Disc 777F

- 3M™ Ceramic Aluminum Oxide blend abrasive grain on a polyester cloth backing
- Heavy-duty YF wt. backing provides great strength and flexibility
- Provides long life and fast cut on multiple surfaces
- Includes a grinding aid for cooler running

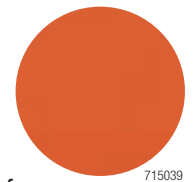

UPC	Grade	Diameter	Qty./Case
Cloth Backing			
051144-88869-6	36	12"	10
051144-88873-3	40		
051144-88872-6	50		
051144-88871-9	60		
051144-88870-2	80		

See pages 72–77 for available accessories.

3M™ Roloc™ Discs

3M™ Roloc™ Discs provide a fast, efficient method for grinding, blending, leveling and finishing on all types of metal. They lock securely in place with just a half twist...another half twist and they're off. Each disc is color coded by grade. (This does not include 3M Roloc TSM products.)

3M™ Roloc™ Disc Button Color/Grade Chart

- 24/Black
- 80/Yellow
- 150/Black
- 36/Brown
- 100/Blue
- 180/Brown
- 50/Green
- 120/White
- 240/Green
- 60/Orange

■ Mild Steel ■ Stainless Steel

Key: Colored square indicates recommended usage.

3M™ Roloc™ Cloth Disc Selection Guide

	Product ID	Mineral	Features	Metal Type	Grinding	Light Grinding	Blending	Deburring
Good	361F	Aluminum Oxide	General purpose grinding, light grinding, blending, and deburring on all metals	All Metals	●	●	●	●
	461F	Silicon Carbide	Ideal for grinding glass, titanium and non-ferrous metals	Titanium		●	●	●
Better	777F	Ceramic A/O* Blend	Durable Y wt. Cloth backing; Grinding aid	Stainless Steel, Nickel Alloy	●	●	●	●
Best	963G	Ceramic Abrasive Grain	Durable backing	Carbon Steel	●	●	●	●
	977F		Durable 2-ply backing; Grinding aid	Stainless Steel, Nickel Alloy	●	●	●	●

*A/O – Aluminum Oxide

3M™ Roloc™ Fiber Disc Selection Guide

	Product ID	Mineral	Features	Metal Type	Grinding	Light Grinding	Blending	Deburring
Good	501C	Aluminum Zirconia	Versatile disc for use on a wide variety of metals; General purpose grinding, blending and finishing on all metals	All Metals	●	●		●
Better	785C	Ceramic A/O* Blend	Excellent for stainless steel; Grinding aid	Stainless Steel	●	●		●
Best	983C/988C	Ceramic Abrasive Grain	Fast cutting; Long life; Designed for a variety of carbon steel applications	Carbon Steel	●	●		●
	988R		Unique single-piece construction that can eliminate button delamination and enhance disc performance; Cut through metal stock to quickly level welds and take on tough jobs in small areas	Mild Steel	●	●		●

*A/O – Aluminum Oxide

3M™ Roloc™ Attachment System Guide

Product ID	Attachment				Dia.	Attachment			
	TP	TR	TSM	TS		TP	TR	TSM	TS
361F	●	●	●		3/4"	●	●		●
461F		●			1"	●	●	●	●
777F		●	●	●	1-1/2"	●	●	●	●
963G		●			2"	●	●	●	●
977F		●			3"	●	●	●	●
501C		●	●		4"	●	●		●
785C		●							
983C/988C		●							
988R		●							

TP

TR

TSM

TS

Optimum Tool Speeds to Maximize 3M™ Roloc™ Disc Cut Rates and Life

Disc Size	Material Type			
	Stainless	Aluminum	Steel	Titanium
1-1/2"	20,000 RPM	30,000 RPM	30,000 RPM	9,000 RPM
2"	15,000 RPM	20,000 RPM	20,000 RPM	7,000 RPM
3"	10,000 RPM	15,000 RPM	15,000 RPM	4,500 RPM
4"	8,000 RPM	9,000 RPM	9,000 RPM	3,000 RPM

See pages 72–77 for available accessories.

3M™ Roloc™ Discs

3M™ Roloc™ Disc 361F ■



- Aluminum oxide on a YF wt. cloth backing
- General purpose grinding, blending and finishing on all metals



UPC	Grade	Max. RPM	Diameter	Min./Case
Roloc TR (Plastic Button) 				
051144-11412-2	36	30,000	1"	50/500
051144-11411-5	50			
051144-11417-7	60			
051144-11416-0	80			
051144-11415-3	P100			
051144-11414-6	P120			
051144-11452-8†	24	30,000	1-1/2"	
051144-22396-1	36			
051144-11137-4	50			
051144-22397-8	60			
051144-22407-4	80			
051144-22408-1	P100			
051144-22409-8	P120	25,000	2"	
051144-11000-1	24			
051144-22398-5	36			
051144-22399-2	50			
051144-22400-5	60			
051144-22401-2	80			
051144-22402-9	P100			
051144-22403-6	P120			
051144-14559-1	P150			
051144-13873-9	P180			
051144-11419-1	P240			

† Made-to-Order

3M™ Roloc™ Disc 361F (cont.)

UPC	Grade	Max. RPM	Diameter	Min./Case		
Roloc TR (Plastic Button) 						
051144-22392-3	24	20,000	3"	50/200		
051144-22393-0	36					
051144-22394-7	50					
051144-22395-4	60					
051144-22404-3	80					
051144-22405-0	P100					
051144-22406-7	P120	12,000	4"			
051144-82244-7	P150					
051144-11418-4	P240					
051144-76429-7	36					
051144-11421-4	60					
051144-11420-7	80				Roloc TSM (Metal Button) 	
051111-49932-0	36	30,000	1-1/2"	50/500		
051111-49933-7	60					
051111-49934-4	80					
051111-51039-1	P100					
051111-51038-4†	P120					
051111-49936-8	36				25,000	2"
051111-49937-5	60					
051111-49938-2	80					
051111-51034-6	P100					
051111-49939-9	P120					
051111-51033-9	36	20,000	3"			
051111-49940-5	60					
051111-49941-2	80					
051111-49942-9	P100					
051111-49943-6	P120			Roloc TP (Metal Button) 		
051111-82401-4	40			25,000	2"	50/200
051111-76806-6	60					
051111-76810-3	80					
051111-77115-8†	100					
051111-22393-0	36	20,000	3"			
051111-22394-7	50					
051111-22395-4	60					
051111-22404-3	80					
051111-22405-0	P100					

† Made-to-Order

■ Mild Steel ■ Stainless Steel

See pages 72–77 for available accessories.

3M™ Roloc™ Discs (cont.)

3M™ Roloc™ Disc 461F

- Silicon carbide on a YF wt. cloth backing gives stainless steel a brighter finish
- Ideal for grinding glass, titanium and non-ferrous metals



51704

UPC	Grade	Max. RPM	Diameter	Min./Case
Roloc TR (Plastic Button)				
051144-12956-0	P60	25,000	2"	50/200
051144-12954-6	P80			
051144-12957-7	P60	20,000	3"	
051144-12955-3	P80			

3M™ Roloc™ Fibre Disc 501C ■

- Aluminum zirconia – Fibre
- Versatile disc for use on a wide variety of metals



159108

UPC	Grade	Max. RPM	Diameter	Min./Case
Roloc TR (Plastic Button)				
051141-20645-5	36	25,000	2"	50/200
051111-50748-3	50			
051111-50749-0	60			
051111-50750-6	80	20,000	3"	
051111-50743-8	36			
051111-50744-5	50			
051111-50745-2	60			
Roloc TSM (Metal Button)				
051111-50755-1	36	25,000	2"	50/200
051111-50756-8	50			
051111-50757-5	60			
051111-50758-2	80	20,000	3"	
051111-50751-3	36			
051111-50752-0	50			
051111-50753-7	60			
051111-50754-4	80			



524509

3M™ Roloc™ Disc 777F ■

- 3M™ Ceramic Aluminum Oxide blend abrasive grain
- Cloth backing for durability
- Grinding aid for cooler running

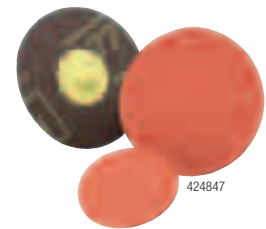

424847



UPC	Grade	Max. RPM	Diameter	Min./Case
Roloc TR (Plastic Button)				
051144-76622-2	36	30,000	1"	50/500
051144-76623-9	50			
051144-76624-6	60			
051144-76625-3	80			
051144-80510-5	P120	25,000	2"	
051144-76626-0	36			
051144-76627-7	50			
051144-76628-4	60			
051144-14660-4	80	20,000	3"	50/200
051144-80511-2	P120			
051144-76629-1	36			
051144-76630-7	50			
051144-76433-4	60	25,000	2"	
051144-14661-1	80			
051144-80508-2	P100			
051144-80512-9	P120			
051144-76631-4	36	20,000	3"	50/200
051144-76632-1	50			
051144-76633-8	60			
051144-76634-5	80			
051144-80509-9	P100	25,000	2"	
051144-80513-6	P120			

■ Mild Steel ■ Stainless Steel

See pages 72–77 for available accessories.

3M™ Roloc™ Discs (cont.)

3M™ Roloc™ Disc 777F (cont.)

UPC	Grade	Max. RPM	Diameter	Min./Case
Roloc TSM (Metal Button) 				
051111-49949-8	36	25,000	2"	50/200
051111-50253-2	60			
051111-50254-9	80			
051111-50255-6	100			
051111-50256-3	P120			
051111-50257-0	36	20,000	3"	
Roloc TP (Metal Button) 				
051144-76770-0†	60	25,000	2"	50/200
051144-76743-4†	36	20,000	3"	
051144-76763-2†				
051144-76767-0†				
051144-76767-0†				
Roloc TS (Plastic Button) 				
051144-76742-7	36	25,000	2"	50/200
051144-76746-5	50			
051144-76750-2	60			
051144-76743-4†	36	20,000	3"	
051144-76747-2†	50			
051144-76751-9	60			
051144-76755-7	80			

† Made-to-Order

3M™ Roloc™ Fibre Disc 785C ■

- 3M™ Ceramic Aluminum Oxide blend abrasive grain – Fibre
- An excellent starting point for stainless steel
- Includes a grinding aid for cooler running



UPC	Grade	Max. RPM	Diameter	Min./Case
Roloc TR (Plastic Button) 				
051144-85882-8†	24	20,000	3"	50/100
051144-85883-5	36			
051144-85884-2	50			
051144-85885-9	60			
051144-85886-6	80			
051144-85887-3	P100	12,000	4"	25/100
051144-85888-0	P120			
051144-83690-1	36			
051144-83691-8	50			
051144-83692-5	60			
051144-83693-2	80	P100		
051144-83694-9	P120			
051144-83695-6	P120			

† Made-to-Order

■ Mild Steel ■ Stainless Steel

See pages 72–77 for available accessories.

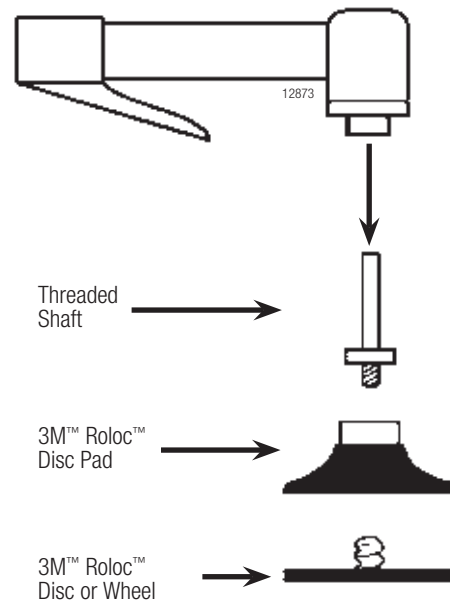

3M™ Roloc™ Discs (cont.)

3M™ Roloc™ Cloth Disc 963G ■

- 3M™ Ceramic abrasive grain
- Durable cloth backing





UPC	Grade	Max. RPM	Diameter	Min./Case		
Roloc TR (Plastic Button) 						
051144-11422-1†	50	30,000	1"	50/500		
051144-11428-3	60					
051144-11427-6	80					
051144-11425-2	120					
051144-11450-4	36					
051144-11448-1	60		1-1/2"			
051144-11455-9	80					
051144-11454-2†	100					
051144-11453-5	120					
051144-11113-8	24				25,000	2"
051144-11112-1	36					
051144-76436-5	40					
051144-11111-4	50					
051144-11110-7	60					
051144-11109-1	80					
051144-11107-7	100					
051144-11106-0	120					
051144-11108-4	24	20,000	3"			
051144-11105-3	36					
051144-11104-6	50					
051144-11103-9	60					
051144-11102-2	80					
051144-11101-5	100					
051144-11100-8	120					

† Made-to-Order

3M™ Roloc™ Durable Edge Disc 977F ■

- 3M™ Ceramic abrasive grain
- Features a durable backing and a grinding aid
- For grinding, blending and deburring of light to medium pressure applications for virtually all metal types



UPC	Grade	Max. RPM	Diameter	Min./Case
Roloc TR (Plastic Button) 				
051144-24094-7	36	25,000	2"	50/200
051144-24096-1	50			
051144-24098-5	60			
051144-24100-5	80			
051144-24095-4	36	20,000	3"	
051144-24097-8	50			
051144-24099-2	60			
051144-24102-9	80			
Roloc TSM (Metal Button) 				
051141-24005-3	36	30,000	1-1/2"	50/500
051141-27348-8†	36			50/200
051141-27393-8	50			
051141-27346-4†	60			
051141-27347-1†	36	25,000	2"	
051141-27392-1†	50			
051141-27345-7†	60			

† Made-to-Order

■ Mild Steel ■ Stainless Steel



See pages 72–77 for available accessories.

3M™ Roloc™ Discs (cont.)

3M™ Roloc™ Disc 977F ■

- 3M™ Ceramic abrasive grain
- Features a grinding aid
- Excellent for stainless steel, titanium and high nickel alloys.



UPC	Grade	Max. RPM	Diameter	Min./Case
Roloc TR (Plastic Button) 				
051144-83587-4	36	25,000	2"	50/200
051144-83588-1	60			
051144-83589-8	80			
051144-83590-4†	36	20,000	3"	
051144-83591-1	60			
051144-83592-8	80			
Roloc TSM (Metal Button) 				
051141-24005-3	36	30,000	1-1/2"	50/500
051141-24006-0	60			
051141-24003-9	36	25,000	2"	
051141-24004-6	60			

† Made-to-Order

3M™ Roloc™ Fibre Disc 983C/988C ■

- 3M™ Ceramic abrasive grain content for fast cutting and long life
- Fibre backing for durability
- Designed for high-pressure weld leveling and deburring



UPC	Grade	Max. RPM	Diameter	Min./Case
Roloc TR (Plastic Button) 				
051144-22352-7	36	25,000	2" 983C	50/200
051111-50005-7	50			
051144-22353-4	60			
051144-22354-1	80			
051144-22349-7	36	20,000	3" 983C	
051144-85890-3	50			
051144-22350-3	60			
051144-22351-0	80			
051111-55753-2	36	12,000	4" 988C	25/100
051111-55754-9	50			
051111-55755-6	60			
051111-55756-3	80			

3M™ Roloc™ Discs 988R ■

- 3M™ Ceramic abrasive grain
- Cuts through metal stock to quickly level welds and take on tough jobs in small areas
- A unique single-piece construction that can eliminate button delamination and enhance disc performance



UPC	Grade	Max. RPM	Diameter	Min./Case
Roloc TR (Plastic Button) 				
051141-20626-4	24	25,000	2"	50/200
051141-20627-1	36			
051141-20628-8	50			
051141-20629-5	60			
051141-20630-1	80	20,000	3"	
051141-20024-8	24			
051141-20025-5	36			
051141-20026-2	50			
051141-20030-9	60	80		
051141-20027-9	80			

■ Mild Steel ■ Stainless Steel

See pages 72–77 for available accessories.

3M™ Belts

3M is the one-stop shop for all of your coated abrasive metalworking belt needs! We offer a product tailored to nearly every application and performance level. To select the best product for your application, check out our easy-to-use Belt Selection Guide. Each tier of product offers best-in-class performance at various price points. Once you have selected the product, use the Availability Guide to select your grade. The following section includes our most popular belt items, but remember, we can provide any size belt that you might need!

Abrasive Speed Recommendations for Off-Hand Applications

Alloy	Belt Speed (surface feet per minute)	Applicable Belt Grades
Cast Iron	7,000	24–120
Carbon Steel	6,500	24–120
Stainless Steel	6,500–7,000	36–120
Nickel Alloys	6,000	36–120
Titanium	2,500–3,000	36–180
Aluminum	7,500–8,500	24–120
	6,500–7,000	Fine Grades
Brass	7,000–8,000	36–180
Rubber	4,500	36–180
Glass	2,500–5,000	80–400
	6,000–8,000	
Stone	7,000	36–180

Tech Tip

Keep Things Cool — When working on heat sensitive alloys like stainless steel, nickel alloys and cobalt alloys, choose a product with a grinding aid.

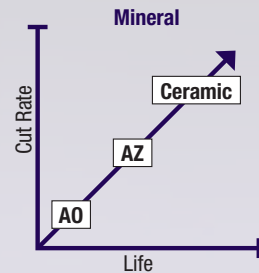
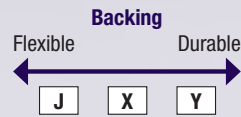

3M™ Coated Belt Availability Guide

3M ID	Mineral	Backing	Grinding Aid	Use Dry/Wet	600	500	400	320	240	220	180	150	120	100	80	60	50	40	36	24
241E	Aluminum Oxide	XE		Dry				P		P	P	P	P	P	●					
302D		J		Dry	P	P	P	P	P	P	P	P	P	P	●	●				
332D		Flex X		Dry			P	P	P	P	P	P	P	P	●	●				
341D		X		Dry			P	P	P	P	P	P	P	P	●	●	●	●	●	●
361F		XF		Dry/Wet			P	P	P	P	P	P	P	P	●	●	●	●	●	●
461F	Silicon Carbide	XF		Dry/Wet	P		P	P	P	P	P	P	P	P	P			P	P	
577F	Alumina Zirconia	YF	Yes	Dry/Wet							●	●	●	●	●	●	●	●	●	●
747D	Ceramic A/O* Blend	X	Yes	Dry								P	P	P	●	●	●		●	
777F		YF	Yes	Dry/Wet							P	P	P	P	●	●	●	●	●	
963G	Ceramic	YN		Dry/Wet									●	●	●	●	●	●	●	●
966F		YF		Dry/Wet										●	●	●	●	●	●	●
977F		YF	Yes	Dry/Wet									●	●	●	●	●	●	●	●
984F	Precision Shaped Ceramic	YF	Yes	Dry/Wet											●	●			●	

*A/O – Aluminum Oxide

See pages 72–77 for available accessories.

ATTENTION: Belts are available in other grades and sizes. If you need a specific belt not listed, contact your 3M Sales Specialist or 3M Authorized Distributor.

How to Use the Coated Abrasive Belt Selection Guide

1. Find the machine type that you will run this belt on.
2. Move down to the metal type that is being worked on.
3. Select the product from the list of **Good** – **Better** – **Best** finishing belts.
4. Check the Availability Guide for the grade.
5. Find the product on the following pages for available sizes.
6. If your size is not listed, contact your 3M distributor or 3M representative for ordering instructions.

Note

For the ultimate in performance for coarse grade grinding in any application, be sure to try the latest innovation: 3M™ Cubitron™ II Metalworking Belts 984F.

3M™ Coated Abrasive Belt Selection Guide



		Portable/ File Tool	Coarse Grade Power Grinding/ High Pressure	Slack of Belt Sander	Stroke Sander	Bench Top Belt Machine	Backstand/ Off Hand	Centerless & Roll Grinding		Flat Finishing	
								Dry	Wet	Dry	Wet
Carbon Steel	Good	241E	577F	341D	—	341D	341D	—	—	341D	361F
	Better	577F	963G	577F	—	577F	577F	577F	577F	577F	577F
	Best	984F	984F	—	—	984F	984F	966F	966F	966F	966F
	Finishing Belt	N/A	N/A	341D/ Trizact*	—	341D/ Trizact*	3XXD**/ Trizact*	777F/ Trizact*	Trizact*	461F	461F
Stainless Steel	Good	—	—	577F	341D	577F	577F	—	—	341D	361F
	Better	577F	577F	777F	—	777F	777F	577F	577F	577F	577F
	Best	984F	984F	—	747D	984F	984F	977F	966F	984F	984F
	Finishing Belt	N/A	N/A	Trizact*	—	Trizact*	3XXD**/ Trizact*	777F/ Trizact*	Trizact*	461F/ Trizact*	461F/ Trizact*
Aluminum, Brass, Bronze	Good	241E	577F	—	—	—	—	—	—	341D	361F
	Better	577F	963G	577F	—	577F	577F	577F	577F	577F	577F
	Best	984F	984F	—	—	984F	984F	—	—	—	—
	Finishing Belt	N/A	N/A	341D/ Trizact*	—	341D/ Trizact*	3XXD**/ Trizact*	341D/ Trizact*	461F	461F	461F
Cobalt and Nickel Alloys	Good	—	—	577F	—	577F	577F	—	—	577F	577F
	Better	577F	577F	777F	—	777F	777F	577F	577F	777F	777F
	Best	984F	984F	—	—	984F	984F	977F	966F	984F	984F
	Finishing Belt	N/A	N/A	Trizact*	—	Trizact*	3XXD**/ Trizact*	777F/ Trizact*	Trizact*	461F	461F
Titanium	Good	—	—	461F	—	461F	461F	—	—	N/A	461F
	Better	577F	577F	577F	—	577F	577F	—	577F	N/A	577F
	Best	984F	984F	—	—	984F	984F	—	966F	N/A	966F
	Finishing Belt	N/A	N/A	461F/ Trizact*	—	461F/ Trizact*	3XXD**/ Trizact*	—	Trizact*	N/A	461F

*For specific Trizact product recommendations, see page 22.

**3XXD: Choose from 302D, 332D and 341D depending upon backing flexibility needed for application.

See pages 72–77 for available accessories.

3M™ Belts

241E

- Aluminum oxide on an XE wt. cloth backing
- High strength backing for tougher applications
- Use with 3M™ File Belt Sander



UPC	Grade	W x L	Min./Case
Portable Tool			
051144-26733-0	60	1/4" x 24"	50/200
051144-26732-3	80		
051144-26731-6	120		
051144-31170-5	60	1/2" x 12"	
051144-26894-8†	80		
051144-26892-4†	120		
051144-72227-3†	60	1/2" x 18"	
051144-72228-0	80		
051144-72229-7†	120		
051144-26725-5†	50	1/2" x 24"	
051144-26723-1	60		
051144-26720-0	80		
051144-26719-4	100		
051144-26717-0†	120		
051144-26715-6	180		
051144-26714-9	220		
051144-14756-4	60		3/4" x 18"
051144-14519-5	80		
051144-14667-3	120		

† Made-to-Order

302D

- Aluminum oxide mineral
- Flexible belt for blending and finishing contoured and complex parts
- Works great on most metals
- Grades 60, 80, P100–P600



UPC	Grade	W x L	Min./Case
051141-30858-6	60	2" x 118"	25/50
051141-30861-6	80		
051141-30864-7	P100		
051141-30867-8	P120		
051141-30870-8	P150		
051141-30873-9	P180		
051141-30876-0	P220		
051141-30879-1	P240		

302D (cont.)

UPC	Grade	W x L	Min./Case
051141-30882-1	P280	2" x 118"	
051141-30885-2	P320		
051141-30888-3	P400		
051141-30891-3	P500		
051141-30894-4	P600	2" x 132"	
051141-30779-4	60		
051141-30710-7	80		
051141-30713-8	P100		
051141-30716-9	P120		
051141-30719-0	P150		
051141-30722-0	P180		
051141-30725-1	P220		
051141-30728-2	P240		
051141-30731-2	P280		
051141-30734-3	P320		
051141-30737-4	P400		
051141-30740-4	P500		
051141-30743-5	P600		
051141-30859-3	60		
051141-30862-3	80		
051141-30865-4	P100		
051141-30868-5	P120		
051141-30871-5	P150		
051141-30874-6	P180	3" x 132"	
051141-30877-7	P220		
051141-30880-7	P240		
051141-30883-8	P280		
051141-30886-9	P320		
051141-30889-0	P400		
051141-30892-0	P500		
051141-30895-1	P600		
051141-30780-0	60		
051141-30711-4	80		
051141-30714-5	P100		
051141-30717-6	P120		
051141-30720-6	P150		
051141-30723-7	P180		
051141-30726-8	P220		
051141-30729-9	P240		
051141-30732-9	P280		
051141-30735-0	P320		
051141-30738-1	P400		
051141-30741-1	P500		
051141-30744-2	P600		

See pages 72–77 for available accessories.

3M™ Belts (cont.)

332D

- Aluminum oxide mineral
- Semi-flexible X wt. backing provides good durability when working on contoured parts
- Works great on most metals
- Grades 60, 80, P100–P400



UPC	Grade	W x L	Min./Case
051141-30776-3	60	2" x 132"	25/50
051141-30746-6	80		
051141-30749-7	P100		
051141-30752-7	P120		
051141-30755-8	P150		
051141-30758-9	P180		
051141-30761-9	P220		
051141-30764-0	P240		
051141-30767-1	P280		
051141-30770-1	P320		
051141-30773-2	P400		
051141-30777-0	60		
051141-30747-3	80		
051141-30750-3	P100		
051141-30753-4	P120		
051141-30756-5	P150		
051141-30759-6	P180		
051141-30762-6	P220		
051141-30765-7	P240		
051141-30768-8	P280		
051141-30771-8	P320		
051141-30774-9	P400		

Tech Tip

Select the right belt for your job.

Choose from 302D, 332D and 341D depending upon backing flexibility needed for application as illustrated below:

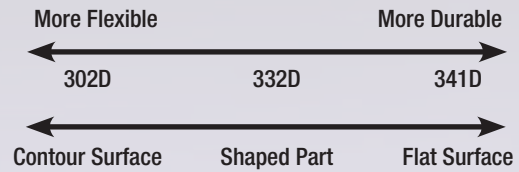

See pages 72–77 for available accessories.

3M™ Belts (cont.)

NEW!

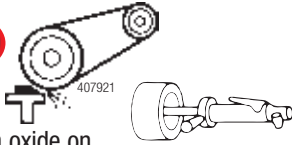

341D

- Aluminum oxide on an X wt. cloth backing
- Excellent all-around abrasive belt for blending and finishing



51724

UPC	Grade	W x L	Min./Case
Backstand, Benchtop, Portable Tool			
051144-26614-2	36	1" x 42"	50/200
051144-31823-0	50		
891040-01450-7	60		25/100
891040-01451-4	80		
891040-01452-1	P100		
891040-01453-8	P120		
051144-26602-9	P150		50/200
051144-26601-2	P180		
051144-26599-2	P240		
051144-26597-8	P320		
051144-26443-8	36	1-1/2" x 60"	10/50
051144-26441-4	40		25/50
051144-26438-4	60		
051144-26436-0	80	2" x 48"	10/50
051144-26571-8	36		
051144-26568-8	50		
051144-26564-0	60		25/50
051144-26562-6	80		
051144-26561-9	P100		
051144-26560-2	P120		
051144-26424-7	50	2" x 60"	10/50
051144-33640-1	60		25/50
051144-33639-5	80		
051144-33667-8	P120		
051144-26320-2	36	2" x 72"	10/50
051144-26316-5	60		25/50
051144-33067-6	80		
051144-26312-7	P120		
051144-26309-7	P180		
051144-81752-8	P240		

341D (cont.)

UPC	Grade	W x L	Min./Case
Backstand, Benchtop, Portable Tool			
051144-26408-7	36	2-1/2" x 60"	10/50
051144-26400-1	60		25/50
051144-26396-7	80		
051144-26388-2	P120	3-1/2" x 15-1/2"	10/50
051144-26857-3	60		
051144-26856-6	80		
891040-02663-0	P120		
891040-01436-1	36	4" x 24"	25
891040-01439-2	60		50
891040-01440-8	80		
051144-33647-0	60	4" x 132"	25
891040-01454-5	36	6" x 48"	10/20
891040-01455-2	40		
891040-01456-9	50		
891040-01457-6	60		
891040-10454-3	80		
891040-10455-0	P100		
891040-10456-7	P120		
051144-26517-6	P150	37" x 60"	5
051144-26515-2	P180		
051144-26513-8	P240		3
051144-74271-4	P120		
051144-14420-4	80	37" x 75"	5
051144-33061-4	P120		
051144-14508-9	P180		

ATTENTION: Belts are available in other grades and sizes. If you need a specific belt not listed, contact your 3M Sales Specialist or 3M Authorized Distributor.

See pages 72–77 for available accessories.

3M™ Belts (cont.)

361F

- Aluminum oxide on an XF wt. backing
- Durable belt with a tough polyester backing that can be used wet or dry
- Ideal use in the grinding of sheets and coils, centerless and hand tool applications



UPC	Grade	W x L	Min./Case
Backstand, Benchtop, Portable Tool			
051111-67159-7†	P180	4" x 90"	50
051111-67179-5†	P320		
051111-68840-3†	P150	8" x 135"	20
051111-68841-0†	P180		
051111-51215-9	P180	37" x 75"	5
051111-68847-2†	80	52" x 75"	
051111-69422-0†	P400		
051119-84596-9†	60	6" x 90"	
051115-27707-8†	P220	6" x 90"	20
051125-09948-6†	P320	8" x 135"	
051144-14773-1	80	37" x 60"	2
051144-14905-6	P100		5
051144-11519-8	P120		
051144-76939-1	P150		
051144-11515-0	P180		
051144-76923-0	P220		
051144-81215-8	P100		
051144-76942-1†	P120		
051144-80037-7	P150	37" x 75"	

† Made-to-Order

461F

- Silicon carbide mineral
- Durable cloth-backed belts
- For heavy duty grinding to fine finishing
- Resistant to tearing and will not easily nick



UPC	Grade	W x L	Min./Case
Backstand, Benchtop, Portable Tool			
051111-67404-8†	P220	4" x 118"	50
051111-67405-5†		4" x 132"	
051111-67408-6†	P320		
051125-23665-2†	P400	4" x 64"	50
051125-67387-4	P100	4" x 106"	5/5
051144-04337-8	P80	4" x 106"	
051144-04335-4†	P120		

† Made-to-Order

577F

- Alumina zirconia on a YF wt. cloth backing
- Resin bonded for heat resistance
- Features a grinding aid for cooler grinding
- Can be run wet or dry

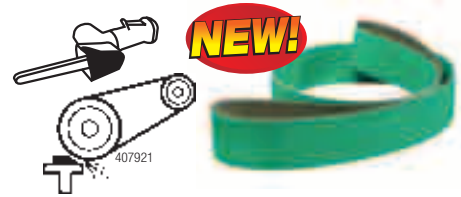

UPC	Grade	W x L	Qty./Case
051141-30690-2	60	1/4" x 18"	50/200
051141-30691-9	80		
051141-30708-4	120		
051141-30694-0	60	1/4" x 24"	
051119-05580-1	80		
051141-30695-7	120	1/2" x 12"	
051111-68668-3	60		
051111-68695-9	80		
051141-30709-1	120	1/2" x 18"	
051141-30686-5	36		
051119-63081-7	60		
051119-82035-5	80		
051141-30689-6	120	1/2" x 24"	
051141-30693-3	36		
051111-68669-0	60		
051111-68696-6	80		
051111-69436-7	120	3/4" x 18"	
051141-30687-2	36		
051115-19553-2	60		
051125-19076-3	80		
051141-30688-9	120	3/4" x 20-1/2"	
051125-16745-1	60		
051111-68697-3	80		
051125-22333-1	120	1" x 18"	
051119-71425-8	60		
051125-23878-6	80		
051141-30692-6	120		
051115-19554-9	60	2" x 48"	25/50
051119-05579-5	80		
051125-11238-3	120		
051141-30699-5	36	2" x 60"	
051111-69103-8	60		
051141-30703-9	80		
051141-30704-6	120	2" x 72"	
051141-30698-8	36		
051111-69104-5	60		
051141-30701-5	80		
051141-30697-1	120		

See pages 72–77 for available accessories.

3M™ Belts (cont.)

577F (cont.)

UPC	Grade	W x L	Qty./Case		
051111-67602-8	36	2" x 132"	25/50		
051141-30702-2	50				
051111-69105-2	60				
051111-69108-3	80				
051141-30696-4	120	2-1/2" x 60"			
051119-64999-4	36				
051111-69106-9	60				
051125-12707-3	80				
051141-30706-0	120	3" x 132"		25/50	
051111-69099-4	36				
051119-82066-9	50				
051111-69569-2	60				
051111-69571-5	80				
051111-67681-3	120				
051119-67701-0†	60	3-1/2" x 15-1/2"	50		
051119-58968-9†	80				
051119-67700-3†	120				
051111-67604-2	36	4" x 132"	25		
051115-27562-3	50				
051111-69570-8	60				
051111-69573-9	80				
051125-23987-5	120				
051111-69445-9	60			6" x 48"	20
051119-83855-8	80				
051141-30707-7	120	37" x 60"	2		
051111-69440-4	36				
051111-68691-1	60				
051111-69111-3	80				
051111-69115-1	120		5		
051125-22740-7	180	37" x 75"	2		
051119-61101-4	36				
051111-68692-8	60				
051111-69112-0	80				
051111-67688-2	120		5		
051125-09283-8	180				

† Made-to-Order

747D

- 3M™ Ceramic Aluminum Oxide blend abrasive grain on an X wt. cloth backing
- Use for offhand heat sensitive stainless steel applications
- Grinding aid enhances performance on stainless steel and other exotic alloys
- Well suited for stroke sanding applications

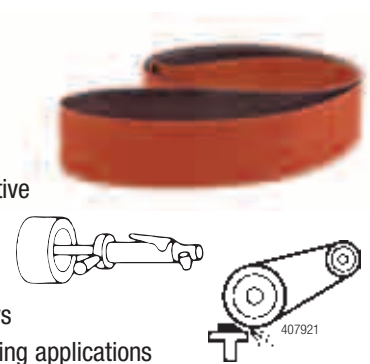

UPC	Grade	W x L	Min./Case
051111-67749-0†	50	3" x 9-1/2"	200
051111-67759-9†	60		
051111-67789-6†	P100		
051111-67806-0†	P120	3" x 118"	50
051111-67807-7†	P120		
051115-27355-1†	60	3" x 132"	10
051111-68923-3†	P120		
051111-67751-3†	50	6" x 264"	20
051111-67766-7†	60		
051111-67778-0†	80		
051125-20535-1†	P100		
051111-67812-1†	P120	6" x 274"	10
051144-85846-0†	60		
051111-67779-7†	80	6" x 300"	20
051111-67767-4†	60		
051111-67781-0†	80	6" x 355"	10
051111-67813-8†	P120		
051115-19560-0†	50	6" x 360"	10
051111-67755-1†	50		

† Made-to-Order

ATTENTION: Belts are available in other grades and sizes. If you need a specific belt not listed, contact your 3M Sales Specialist or 3M Authorized Distributor.

See pages 72–77 for available accessories.

3M™ Belts (cont.)

777F

- 3M™ Ceramic Aluminum Oxide blend abrasive grain on a YF wt. cloth backing
- Contains grinding aid which enhances performance on stainless steel and other exotic alloys
- Can be run wet or dry

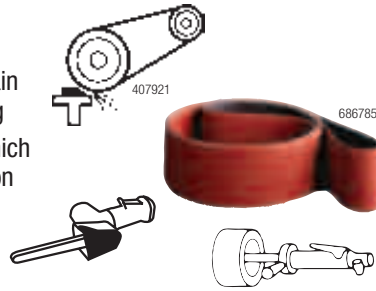

UPC	Grade	W x L	Min./Case
Backstand, Benchtop, Portable Tool			
051144-84403-6	60	1/4" x 18"	200
051144-85318-2	80		
051144-19579-2	P120		
051144-84412-8	40	1/4" x 24"	
051144-80253-1	60		
051144-77642-9	80		
051144-82229-4	P120	1/2" x 12"	
051111-69457-2	60		
051144-85372-4	80		
051111-69604-0	P120	1/2" x 18"	
051144-84301-5	36		
051144-84409-8	40		
051144-80551-8	60	1/2" x 24"	
051144-80232-6	80		
051144-84304-6	P120		
051144-77643-6	36	1/2" x 24"	
051144-82342-0	40		
051144-77408-1	50		
051144-77065-6	60	3/4" x 18"	
051144-77491-3	80		
051144-81064-2	P120		
051144-84302-2	36	3/4" x 20-1/2"	
051144-84404-3	60		
051144-77992-5	80		
051144-84303-9	P120	1" x 18"	
051144-80486-3	60		
051144-80686-7	80		
051125-23897-7	60	1" x 42"	
051144-85319-9	80		
051141-30705-3	P120		
051144-76527-0	40	1" x 42"	50/200
051144-77512-5	60		
051144-14895-0	80		
051144-84416-6	60	1-1/2" x 60"	25/50
051144-76731-1	80		
051144-82022-1	P120		

777F (cont.)

UPC	Grade	W x L	Min./Case	
Backstand, Benchtop, Portable Tool				
051144-76738-0	36	2" x 48"	10/50	
051144-76519-5	60		25/50	
051144-14896-7	80			
051144-85393-9	P120	2" x 60"	50	
051144-77663-4	36			
051144-77152-3	60			
051144-84296-4	80			
051144-85377-9	P120	2" x 72"		
051144-76531-7	36			
051144-80286-9	60			
051144-14884-4	80			
051144-81767-2	P120	2" x 132"		
051144-14264-4	36			
051144-14899-8	50			
051144-82231-7	60			
051144-14534-8	80	2-1/2" x 60"		
051144-81687-3	P120			
051144-84315-2	P180			
051144-76532-4	36			
051144-77825-6	40	3" x 132"	25	
051144-76680-2	60			
051144-76686-4	80			
051115-27389-6	P120			
051144-76533-1	36	3-1/2" x 15-1/2"	50	
051111-69455-8	50			
051144-76520-1	60			
051144-76514-0	80			
051144-80028-5	P120	4" x 132"		25
051144-85762-3	P180			
051144-77336-7	36			
051144-77334-3	50			
051144-77476-0	60	4" x 132"	25/50	
051144-77333-6	80			
051144-84306-0	100			
051144-84307-7	P120			
051144-85320-5	P180	4" x 132"	25	
051144-76534-8	36		25/50	
051111-67851-0	50			
051144-80707-9	60		25	
051144-76515-7	80	25		
051141-30700-8	P120			

ATTENTION: Belts are available in other grades and sizes. If you need a specific belt not listed, contact your 3M Sales Specialist or 3M Authorized Distributor.

See pages 72–77 for available accessories.

3M™ Belts (cont.)

777F (cont.)

UPC	Grade	W x L	Min./Case
Backstand, Benchtop, Portable Tool			
051144-82313-0	36	6" x 48"	10/20
051144-80176-3	50		
051144-76679-6	60		
051144-76733-5	80		
051144-82153-2	P120	37" x 60"	2
051125-33828-8	36		
051115-27354-4	60		
051144-77351-0	80		
051144-80450-4	P120		5
051111-69127-4	P180		
051119-75481-0	36		
051111-69122-9	60	37" x 75"	2
051144-82930-9	80		
051144-84947-5	P120		5
051111-69128-1	P180		

963G

- 3M™ Ceramic abrasive grain on a YN wt. cloth backing
- Water-resistant polyester cloth backing for heavy grinding
- Can be run wet or dry

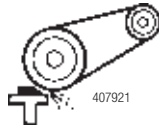

312049

UPC	Grade	W x L	Qty./Case
Backstand, Benchtop			
051144-74228-8†	24	2" x 132"	50
051111-68163-3	60		50
051144-74229-5†	24	3" x 132"	25
051144-74207-3	36 L-flex		
051144-74324-7	60		
051144-13715-2	80 L-flex		
051111-68109-1†	24	4" x 132"	25
051144-74209-7	36		
051144-74330-8	40		
051144-74325-4	60		
051144-84491-3†	36	6" x 132"	10
051111-68168-8†	60		20

† Made-to-Order

966F

- 3M™ Ceramic abrasive grain on a YF wt. cloth backing
- Water-resistant polyester cloth backing
- Resin bonded for heat resistance
- Designed for wet centerless grinding applications on carbon steel, heat sensitive high nickel alloys, titanium and stainless steel
- Ideal for stripping chrome from old parts

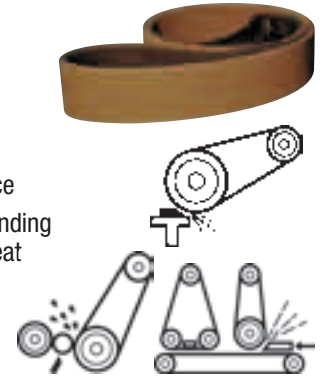

UPC	Grade	W x L	Qty./Case
051119-09003-1†	36	3" x 132"	25
051119-78104-5	36	4" x 132"	
051119-10654-1†	80		
051119-78105-2†	80 sine	4" x 132"	10
051115-27128-1	60		
051111-68321-7†	36	9" x 120"	20
051115-27315-5	50		
051125-14381-3	60		
051111-68326-2†	80		5
051115-27404-6†	80 L-flex		
051125-12989-3†	40	12 x 144"	5
051115-27990-4	50		
051119-83152-8†	60	Belt sizes made to order. Specify UPC, grade and belt size (W" x L")	Determined by belt size.
051135-13609-6	24		
051135-13660-7	36		
051135-13684-3	40		
051135-13683-6	50		
051135-13682-9	60	80	
051135-13681-2	80		

† Made-to-Order

See pages 72–77 for available accessories.

3M™ Belts (cont.)

977F

- 3M™ Ceramic abrasive grain on a YF wt. cloth backing
- Recommended for both wet or dry grinding of stainless steel and high nickel alloys
- Works well in all grinding pressures

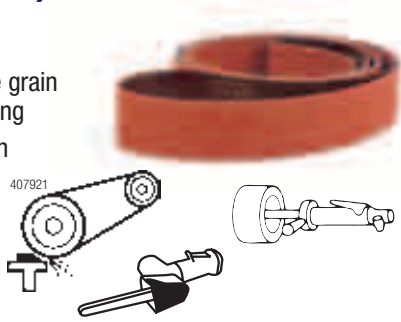

159098

UPC	Grade	W x L	Qty./Case	
051111-68989-9†	60	1" x 11"	500	
051111-68602-7†	80			
051111-68527-3†	40	1" x 42"	200	
051115-27684-2†	120			
051111-68530-3†	40	1" x 132"	100	
051111-68548-8†	50		200	
051111-68583-9†	60			
051115-27336-0†	80			
051111-68532-7†	40	2" x 48"	50	
051119-09500-5†	60			
051144-85389-2	36	2" x 72"	50	
051111-69519-7†	40			
051111-68552-5†	50			
051144-85383-0	60			
051144-84008-3	80			
051111-69514-2	120			
051111-68534-1†	40 L-flex			
051111-68535-8†	40			
051144-83522-5	36	2" x 132"	50	
051111-68537-2†	40			
051144-85015-0	50			
051144-85384-7	60			
051144-85769-2	80			
051111-68631-7†	100			
051111-68640-9†	120			
051111-68485-6†	24			
051111-68506-8†	36 L-flex	3" x 132"	25	
051111-68507-5†	36			
051144-82798-5	40			
051111-68557-0†	50 L-flex			
051111-69165-6†	50			
051111-69166-3†	60			
051119-08175-6†	60 full flex			
051144-85378-6	80			
051119-77855-7†	100			
051111-68645-4†	120			50

977F (cont.)

UPC	Grade	W x L	Qty./Case
051111-69522-7†	60	3-1/2" x 15-1/2"	50
051125-18646-9†	80		
051125-23841-0†	100		
051111-68593-8†	60	4" x 90"	50
051125-10597-2†	80		
051125-11234-5†	120		
051144-85390-8†	36 L-flex	4" x 132"	25
051111-68511-2†	36		
051119-65751-7†	40		
051125-15945-6†	40 full flex		
051111-69351-3†	50		
051111-69352-0†	50 L-flex		
051115-27540-1†	60		
051111-68594-5†	60 L-flex		
051111-68619-5†	80		
051144-85387-8†	40 L-flex		
051125-17018-5†	40 full flex		
051111-68518-1†	36 sine		
051115-19611-9†	36 film		
051111-68596-9†	60	8" x 132"	20
051115-27541-8†	80		
051111-68524-2†	36		
051111-68597-6†	60		

† Made-to-Order

ATTENTION: Belts are available in other grades and sizes. If you need a specific belt not listed, contact your 3M Sales Specialist or 3M Authorized Distributor.

See pages 72–77 for available accessories.

3M™ Belts (cont.)

3M™ Cubitron™ II Metalworking Belt 984F

- 3M precision-shaped grain
- Average up to 30% faster cutting on hard-to-grind metals than the next-best competitive belt
- Lasts up to 4 times as long as conventional ceramic aluminum oxide belts
- Cuts cooler — diverts heat from the work piece and belt to the swarf
- Helps eliminate burnishing and heat stress



UPC	Grade	W x L	Min./Case	
051141-55032-9	60+	1/4" x 24"	50/200	
051141-55053-4	80+	1/2" x 12"		
051141-27511-6	36+	1/2" x 18"		
051141-55041-1	60+			
051141-55048-0	80+	1/2" x 24"		
051141-27512-3	36+			
051141-55031-2	60+			
051141-55054-1	80+	1/2" x 42"		200
051141-55040-4†	60+			
051141-55064-0	36+	3/4" x 18"		50/200
051141-55030-5	60+			
051141-55047-3	80+			
051141-55065-7	36+	3/4" x 20-1/2"	50/200	
051141-55055-8	80+			
051141-55046-6	60+	1" x 11"	50/500	
051141-55050-3†	80+			
051141-55060-2†	80+	1" x 42"	25/200	
051141-27514-7	36+	1" x 132"	100	
051141-55039-8	60+		25/200	
051141-55052-7	80+			
051141-55066-4†	36+	1-1/2" x 132"	25/50	

† Made-to-Order

3M™ Cubitron™ II Metalworking Belt 984F (cont.)

UPC	Grade	W x L	Min./Case
051141-55068-8	36+	2" x 60"	10/50
051141-55036-7†	60+		25/50
051141-27516-1	36+	2" x 72"	50
051141-55034-3	60+		25/50
051141-55057-2	80+		
051141-55067-1	36+	2" x 118"	10/50
051141-27460-7	36+	2" x 132"	50
051141-55044-2	60+		25/50
051141-55056-5	80+	2-1/2" x 60"	
051141-55069-5	36+		25/50
051141-27853-7†	60+		
051141-55058-9†	80+	3" x 132"	25
051141-27461-4	36+		
051141-55043-5	60+	3-1/2" x 15-1/2"	50
051141-55051-0	80+		
051141-55042-8	60+		
051141-55049-7	80+	4" x 132"	25
051141-27462-1	36+		
051141-55070-1	36+	5" x 132"	10/20
051141-55071-8	36+	6" x 48"	
051141-55037-4	60+		20
051141-55059-6†	80+		
051141-55035-0	60+	6" x 60"	10/20
051141-27515-4	36+	6" x 132"	
051141-55072-5	36+	8" x 107"	5/10
051141-27513-0	36+	8" x 132"	10
051141-55063-3†	80+	37" x 60"	2
051141-55062-6†	80+	37" x 75"	

† Made-to-Order

See pages 72–77 for available accessories.

3M Precision Shaped Grain



Conventional Grain

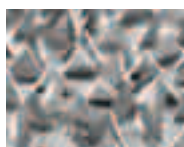

Precision-Shaped Grain

Triangular-shaped grain (right) is electrostatically oriented to form sharp peaks, each acting like individual cutting tools that wear evenly for super long life and consistency.



Conventional Ceramic



3M™ Cubitron™ II

3M precision shaped grain sharpens as it wears compared to conventional ceramic abrasive grain so 3M™ Cubitron™ II abrasive belts last longer!

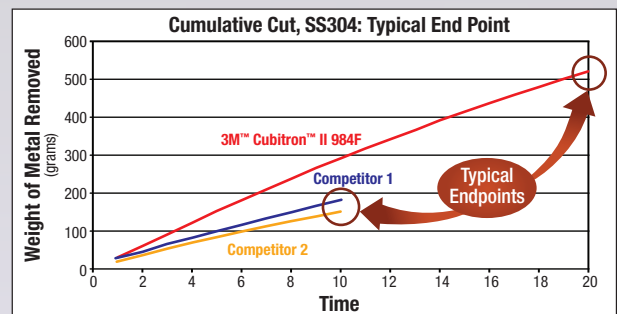

3M™ Trizact™ Abrasive Belts

The unique microreplicated construction used in 3M™ Trizact™ Abrasives can deliver consistent, predictable finishes, higher, more even rates of cut, cooler grinding and finishing temperatures, and reduced processing steps. 3M invented microreplication technology, which is the science of creating small, precisely shaped three-dimensional structures and then reproducing them on a variety of surfaces.

Trizact Abrasive Grading System

The unique construction of Trizact abrasives requires a different grading system. Grade is defined by the average particle size in microns and begins with an “A”.

Trizact Abrasive Grade	FEPA (P-Grade)
A5	P3000
A6	—
A10	P1500
A16	P1200
A20	P1000
A30	P600
A35	—
A45	P400
—	P320
A60	—
A65	—
A75	P240
A80	—
A90	P220
A100	P180
A110	P180
A130	P150
A160	P120

The Difference is in the Construction

Trizact abrasives allow you to say “goodbye” to erratic, inconsistent finishes generated by conventional coated abrasives. Here’s why:



Three-dimensional structures uniformly distributed over the entire surface of 3M™ Trizact™ Abrasives (left) ensure consistent performance and eliminate belt-to-belt variation. Conventional abrasives (right), which feature randomly arranged minerals, wear and finish unevenly.



Conventional abrasives start out sharp, but they dull quickly.



3M™ Trizact™ Abrasives have three-dimensional structures containing multiple layers of abrasive mineral. As these pyramid-like structures wear, fresh, sharp mineral is exposed.

ATTENTION: Belts are available in other grades and sizes. If you need a specific belt not listed, contact your 3M Sales Specialist or 3M Authorized Distributor.

3M™ Trizact™ Belts

3M™ Trizact™ 217EA

- Ideal for aluminum, copper, brass and zinc alloys to final finishing

- Good for low pressure application

- Flexible belt for intermediate finish and dimensioning

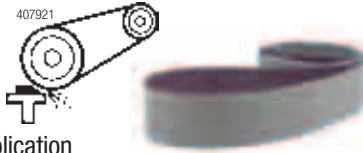

UPC	Grade	W x L	Min./Case
051125-23664-5†	A45	4" x 84"	50
051125-15686-8†	A45	4" x 106"	
051125-20639-6†	A6	4" x 118"	
051125-14350-9†	A16		
051111-66834-4†	A30		
051125-13733-1†	A45		
051125-16987-5†	A16	4" x 120"	
051111-66830-6†	A6	4" x 132"	
051111-69360-5†	A16		
051111-66835-1†	A30		
051111-66841-2†	A45		
051111-69669-9†	A65		
051119-05828-4†	A80		
051125-12699-1†	A30	4" x 168"	
051125-12479-9†	A80		

† Made-to-Order

3M™ Trizact™ 237AA

- Semi-flexible abrasive
- Aluminum oxide mineral
- Great choice for stainless steel finishes

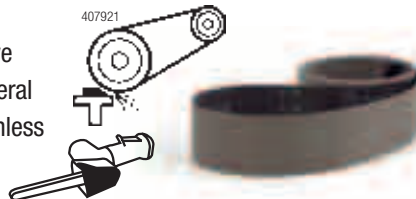

UPC	Grade	W x L	Qty./Case
051119-82624-1†	A6	1" x 11"	500
051125-32361-1†	A16		
051115-27208-0†	A45		
051111-66892-4†	A65		
051111-69366-7†	A100	1" x 12"	200
051125-22681-3†	A100		
051111-69377-3†	A30	1" x 30"	20
051125-15699-8†	A16	1" x 42"	
051125-08603-5†	A100		
051111-69676-7†	A160	1" x 60"	200
051119-09095-6†	A6		
051119-09093-2†	A16		
051119-10286-4†	A45		
051115-27051-2†	A65		

† Made-to-Order

3M™ Trizact™ 237AA (cont.)

UPC	Grade	W x L	Qty./Case
051119-10263-5†	A6	1" x 64"	200
051125-55143-4†	A16	1" x 65"	
051111-66945-7†	A100	1" x 130"	20
051115-27112-0†	A45	1" x 132"	200
051115-27111-3†	A100		
051115-27804-4†	A100	2" x 34"	50
051111-69673-6†	A16	2" x 48"	25/50
051115-27731-3†	A30		
051119-09379-7†	A45		
051125-20671-6†	A80		
051111-69043-7†	A100	2" x 60"	50
051119-84184-8†	A160		
051115-27408-4†	A65		
051119-59769-1†	A80		
051125-54544-0†	A100		
051115-27487-9†	A16		
051115-27653-8†	A30	2" x 72"	25/50
051115-27787-0†	A65		
051115-27904-1†	A80		
051111-69671-2†	A100		
051115-27849-5†	A160	2" x 107"	50
051111-69369-8†	A16		25/50
051111-69680-4†	A45	2" x 118"	50
051111-66938-9†	A80		25/50
051111-69383-4†	A6	2" x 132"	50
051111-66860-3†	A16		
051125-22263-1†	A30	2" x 148"	25/50
051111-66856-6†	A6		
051111-69370-4†	A16		
051115-27658-3†	A30		
051111-69028-4	A45	2" x 157"	50
051111-69036-9†	A65		
051111-69044-4	A100	2" x 172"	200
051119-77007-0†	A16		
051125-20169-8†	A100	2" x 182"	200
051125-22175-7†	A65		
051111-69294-3†	A6	3" x 24"	200
051111-69290-5†	A16		
051111-69291-2†	A30	3" x 30"	200
051125-14935-8†	A80		
051119-83067-5†	A16	3" x 36"	200
051111-69045-1†	A100		
051119-82467-4†	A80	3" x 42"	25/50
051111-69295-0†	A160		

† Made-to-Order

3M™ Trizact™ Belts (cont.)

3M™ Trizact™ 237AA (cont.)

UPC	Grade	W x L	Qty./Case
051111-69015-4†	A16	3" x 90"	50
051111-69021-5†	A30		
051111-69029-1†	A45		
051111-69047-5†	A100		
051111-66863-4†	A16	3" x 118"	50
051111-69022-2†	A30		
051125-19954-4†	A6	3" x 132"	50
051111-51199-2	A16		
051111-51207-4	A30		
051111-51209-8	A45		
051111-69037-6†	A65		
051111-69051-2†	A160		
051111-66864-1†	A16	3" x 148"	25
051111-69292-9†	A30		
051111-69293-6†	A45		
051115-26995-0†	A45	3" x 157"	50
051115-27921-8†	A65		
051125-19529-4†	A80		
051115-27798-6†	A16	3" x 168"	25
051111-66876-4†	A30		
051115-28033-7†	A45		
051111-69371-1†	A16	3" x 300"	50
051111-69381-0†	A45		
051111-69385-8†	A65		
051115-27777-1†	A80	3" x 346"	25
051115-27145-8†	A65		
051111-66949-5†	A100	4" x 36"	50
051125-11794-4†	A100		
051119-68279-3†	A100	4" x 48"	50
051115-27859-4†	A16		
051125-10967-3†	A65	4" x 84"	50
051119-67382-1†	A100		
051115-27749-8†	A6	4" x 90"	25/50
051111-69016-1†	A16		
051111-51204-3	A30		
051111-69030-7†	A45		
051119-73517-8†	A65		
051115-27592-0†	A80		
051111-69672-9†	A100		
051115-27593-7†	A160		

† Made-to-Order

3M™ Trizact™ 237AA (cont.)

UPC	Grade	W x L	Qty./Case
051115-27153-3†	A30	4" x 106"	50
051115-26818-2†	A100		
051111-66867-2†	A16	4" x 118"	50
051111-66878-8†	A30		
051111-66888-7†	A45		
051111-66897-9†	A65		
051125-17651-4†	A100		
051115-26883-0†	A30	4" x 124"	25/50
051111-69251-6†	A6	4" x 132"	
051111-69017-8	A16		
051111-51214-2	A30		
051111-69031-4†	A45		
051111-69387-2†	A65		
051111-66941-9†	A80		
051111-69048-2†	A100		
051111-69375-9†	A160		
051111-66950-1†	A100	4" x 146"	50
051125-11757-9†	A45	4" x 158"	
051115-27521-0†	A16	4" x 168"	50
051119-10264-2†	A30		
051119-08908-0†	A65		
051111-69681-1†	A45	4" x 274"	25
051115-27303-2†	A160	4" x 352"	
051115-27467-1†	A65	4" x 354"	50
051111-68739-0†	A100		
051111-68738-3†	A160		

† Made-to-Order

ATTENTION: Belts are available in other grades and sizes. If you need a specific belt not listed, contact your 3M Sales Specialist or 3M Authorized Distributor.

3M™ Trizact™ Belts (cont.)

3M™ Trizact™ 253FA

- Ideal for wet flat-finishing and wet intermediate finishing of centerless applications
- Great on stainless steel, carbon steel and carbon fibre composites

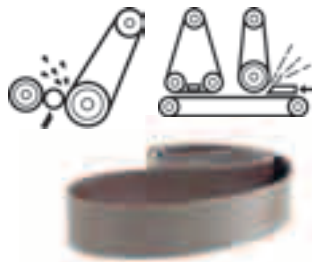

UPC	Grade	W x L	Min./Case
051135-13635-5	A6	Belt sizes made to order. Specify UPC, grade and belt size (W" x L"). Belts wider than 25" require multiple splices.	Determined by belt size.
051135-13636-2	A16		
051135-13637-9	A30		
051135-13638-6	A45		
051135-13639-3	A65		
051135-13640-9	A80		
051135-13641-6	A100		

3M™ Trizact™ 307EA

- Flexible cloth backing
- Aluminum oxide mineral
- Perfect choice for preplate surface finishes

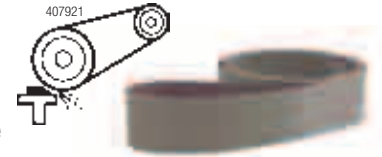

UPC	Grade	W x L	Min./Case
051111-67100-9†	A80	1" x 42"	200
051111-69408-4†	A100		50/200
051111-67101-6†	A80	1" x 60"	200
051115-27801-3†	A16	1" x 72"	
051115-27448-0†	A45		
051125-14659-3†	A65		
051119-63318-4†	A6	1" x 76"	
051125-50495-9†	A30	1" x 77"	
051111-67055-2†	A6		
051111-67068-2†	A30		
051115-19520-4†	A45		25/200
051115-26828-1†	A6	1" x 132"	200
051115-27410-7†	A16		
051115-27346-9†	A45		
051115-27491-6†	A80		
051125-20660-0†	A30	2" x 17"	50
051115-27830-3†	A16	2" x 36"	
051125-40962-9†	A65	2" x 48"	
051119-58606-0†	A30	2" x 60"	
051119-75663-0†	A45		
051125-46217-4†	A65	2" x 72"	
051125-11024-2	A6		
051111-69061-1	A16		
051111-69067-3	A30		
051111-69072-7†	A45		
051111-69074-1†	A65		
051111-69079-6	A100		
051125-34816-4	A30	2" x 76"	
051111-61067-1†	A6	2" x 83"	
051111-61066-4	A16	2" x 90"	50
051115-27125-0†			
051125-47160-2†	A65	2" x 96"	
051111-68818-2†	A6	2" x 118"	
051119-09343-8†	A16		
051125-20950-2†	A30		
051125-20345-6†	A45		

† Made-to-Order



3M™ Trizact™ Belts (cont.)

3M™ Trizact™ 307EA (cont.)

UPC	Grade	W x L	Min./Case	
051111-51206-7	A6	2" x 132"	25/50	
051111-51202-9	A16			
051111-69068-0	A30			
051111-51210-4	A45			
051111-69075-8	A65			
051111-69077-2	A80			
051111-69080-2	A100			
051111-69409-1†	A16		2" x 138"	50
051111-67059-0†	A6			
051115-19517-4†	A16	2" x 148"	25/50	
051111-69069-7†	A30			
051125-20168-1†	A45			
051111-67091-0†	A65			
051111-67064-4†	A16		3" x 60"	50
051115-27893-8†				
051125-38992-1†	A30	3" x 72"	25/50	
051125-30837-3†	A100			
051111-69410-7†	A16	3" x 90"	50	
051125-49713-8†	A65			
051111-67077-4†	A30	3" x 96"	50	
051111-69256-1†	A65			
051111-68819-9†	A6	3" x 118"	50	
051111-69063-5†	A16			
051111-51203-6	A30			
051111-67084-2†	A45			
051111-67106-1†	A80			
051111-67111-5†	A100			
051115-27418-3†	A16	3" x 120"	50	
051125-20567-2†	A30			
051125-30879-3†	A45			
051111-69059-8†	A6			
051125-13220-6†	A16 full flex	3" x 132"	25/50	
051111-51200-5	A16			
051111-51201-2	A30			
051125-16874-8†	A30 full flex			
051111-69073-4	A45			
051111-69076-5†	A65			
051111-69078-9	A80	3" x 148"	50	
051111-69082-6†	A100			
051111-67065-1†	A16	3" x 168"	25/50	
051115-27594-4†	A6			
051115-19518-1†	A16			
051111-67087-3†	A45			

† Made-to-Order

3M™ Trizact™ 307EA (cont.)

UPC	Grade	W x L	Min./Case
051115-27604-0†	A30	4" x 36"	50
051111-69060-4†	A6	4" x 90"	
051111-69064-2†	A16		
051115-19522-8†	A65	4" x 118"	25/50
051125-22401-7†	A6		
051111-69065-9	A16		
051111-69070-3†	A30		
051111-67107-8†	A80		
051111-67112-2†	A100		
051115-27766-5†	A6	4" x 132"	50
051111-69066-6†	A16		
051111-69071-0	A30		
051111-51212-8	A45		
051115-26922-6†	A80		
051119-73781-3†	A100		
051111-68821-2†	A30	4" x 168"	25
051115-26997-4†	A16	4" x 240"	
051111-67113-9†	A100		

† Made-to-Order

3M™ Trizact™ 327DC

- Use for mill line removal, intermediate scratch refinement, consistent dimensioning and consistent finishing applications
- Macroreplicated aluminum oxide on a flexible backing
- Grinding aid
- For dry use only



UPC	Grade	W x L	Min./Case
051135-94693-0	A30	Belt sizes made to order. Specify UPC, grade and belt size (W" x L"). Belts wider than 25" require multiple splices.	Determined by belt size.
051135-94692-3	A45		
051135-94691-6	A65		
051135-94690-9	A100		
051135-29683-7	A160		
051135-94689-3	A300		

ATTENTION: Belts are available in other grades and sizes. If you need a specific belt not listed, contact your 3M Sales Specialist or 3M Authorized Distributor.

3M™ Trizact™ Belts (cont.)

3M™ Trizact™ CF 337DC

- Macroreplicated structure provides long product life and consistent cut and finish

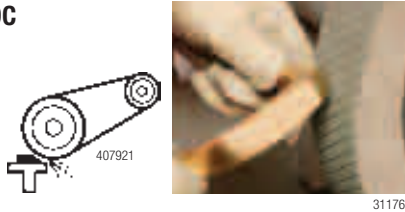

UPC	Grade	W x L	Qty./Case
Backstand			
051141-20646-2†	A300	1" x 132"	100
048011-33156-0	A45	2" x 60"	5
048011-33155-3	A65		
048011-33154-6†	A100		
048011-33153-9†	A160		
048011-33152-2†	A300		
048011-33161-4†	A45	2" x 72"	
048011-33160-7†	A65		
048011-33159-1†	A100		
048011-33158-4†	A160		
048011-33157-7†	A300		
048011-33166-9†	A45	2" x 132"	
048011-33165-2†	A65		
048011-33164-5†	A100		
048011-33163-8†	A160		
048011-33162-1†	A300		
048011-33171-3†	A45	3" x 132"	
048011-33170-6†	A65		
048011-33169-0†	A100		
048011-33168-3†	A160		
048011-33167-6†	A300		

† Made-to-Order

3M™ Trizact™ 347FC

- 3M™ Ceramic abrasive grain on a macroreplicated, flexible X wt. backing
- For high-pressure applications on hard metals, nickel alloys, titanium and stainless steel



UPC	Grade	W x L	Min./Case
051125-64275-0	A30	Belt sizes made to order. Specify UPC, grade and belt size (W" x L"). Belts wider than 25" require multiple splices.	Determined by belt size.
051125-64274-3	A45		
051125-64273-6	A65		
051125-64272-9	A100		
051125-64271-2	A160		
051125-64270-5	A300		

3M™ Trizact™ Cloth Belts 363FC

- Centerless/cylindrical/flat part grinding and finishing
- Macroreplicated aluminum oxide on a durable YF wt. cloth backing
- Use wet on zirconium, titanium, carbon steel, stainless steel and other alloys
- Long belt life improves productivity
- Reduce or eliminate belt break-in
- Consistent cut rate and finish from heavy deburring and defect removal to intermediate finishing

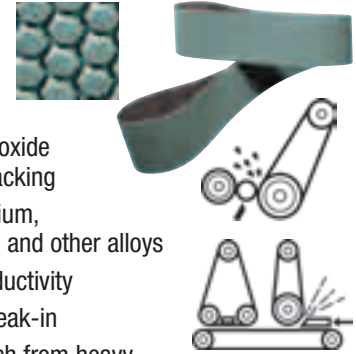

UPC	Grade	Common Sizes W x L	Min./Case
051135-98214-3	A30	Belt sizes made to order. Specify UPC, grade and belt size (W" x L"). Belts wider than 25" require multiple splices.	Determined by belt size.
051135-98213-6	A45		
051135-98212-9	A65		
051135-98211-2	A100		
051135-98210-5	A160		
051135-98209-9	A300		

3M™ Trizact™ 407EA

- Use for mill line removal, intermediate scratch refinement, consistent dimensioning and consistent finishing applications
- Silicon carbide constructed on a flexible rayon cloth backing
- Grinding aid for cooler grinding
- Resin bonded for heat resistance



UPC	Grade	W x L	Min./Case
051135-91841-8	A20	Belt sizes made to order. Specify UPC, grade and belt size (W" x L"). Belts wider than 25" require multiple splices.	Determined by belt size.
051144-99004-7	A60		
051144-99005-4	A90		
051135-90527-2	A110		

3M™ Trizact™ Belts (cont.)

3M™ Trizact™ Cloth Belts 463FC

- Wet centerless/flat part/ finishing/polishing
- Macroreplicated silicon carbide on a durable YF wt. cloth backing
- Use wet on zirconium, titanium, carbon steel, stainless steel and other alloys
- Long belt life improves productivity
- Reduce or eliminate belt break-in
- Consistent finer grade ranges for fine finishes on all metals.

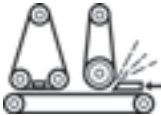

UPC	Grade	W x L	Min./Case
051135-98191-7	A6	Belt sizes made to order. Specify UPC, grade and belt size (W" x L"). Belts wider than 25" require multiple splices.	Determined by belt size.
051135-97955-6	A10		
051135-97954-9	A20		
051135-98047-7	A30		
051135-97953-2	A45		

3M™ Trizact™ Belts 953FA

- Use in wet centerless or flat grinding and finishing operations
- Process flexible belt that delivers consistent, predictable results
- Macroreplicated ceramic abrasive grain coated on waterproof cloth backing

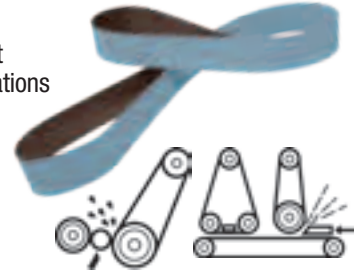

UPC	Grade	W x L	Qty./Case
051135-29383-6	A6	Belt sizes made to order. Specify UPC, grade and belt size (W" x L"). Belts wider than 25" require multiple splices.	Determined by belt size.
051135-29507-6	A10		
051135-29382-9	A16		
051135-29381-2	A30		
051135-29380-5	A45		
051135-29379-9	A65		
051135-29378-2	A80		
051135-29377-5	A100		
051135-29375-1	A160		
051135-29373-7	A300		

ATTENTION: Belts are available in other grades and sizes. If you need a specific belt not listed, contact your 3M Sales Specialist or 3M Authorized Distributor.

Utility Cloth Sheets and Rolls

A good choice for all your utility sanding and general maintenance work. Can be torn and rolled without shelling.

3M™ Utility Cloth Sheet and Roll Selection Guide

	Product ID	Mineral	Backing	Features	Blending	Finishing	Cleaning
Good	011K	Aluminum Oxide	Flexible Utility Cloth	Closed Coat; General purpose use	●	●	●
Better	211K	Aluminum Oxide	Flexible Utility Cloth	Use for all general maintenance work		●	
Best	314D	Premium Aluminum Oxide	Durable Cloth	Strong bonding system for shelling resistance	●	●	●

3M™ Utility Cloth Sheets 011K

- Aluminum Oxide mineral
- General purpose use



UPC	Grade	W x L	Min./Case
Sheets			
051144-02433-9	CRS	9" x 11"	50/250
051144-02432-2	MED		
051144-02431-5	FINE		

3M™ Utility Cloth Sheets and Rolls 211K

- Aluminum oxide on a J wt. cloth backing
- Use these flexible utility rolls and sheets for general applications such as deburring, rust removal, strapping and all general maintenance work



UPC	Grade	W x L	Min./Case
Sheets			
051144-02410-0	80	9" x 11"	50/250
051144-02409-4	100		
051144-02408-7	120		
051144-02407-0	150		
051144-02406-3	180		
051144-02405-6	220		
051144-02404-9	240		
051144-02402-5	320		
051144-12501-2	400		
051144-12500-5	500		

3M™ Utility Cloth Sheets and Rolls 211K (cont.)

UPC	Grade	W x L	Min./Case
Utility Rolls			
051144-05010-9	80	1" x 50 yds.	
051144-05009-3	100		
051144-05008-6	120		
051144-05007-9	150		
051144-05006-2	180		
051144-05005-5	220		
051144-05004-8	240		
051144-05003-1	280		
051144-05002-4	320		
051144-05001-7	400		
051144-05000-0	500	1-1/2" x 50 yds.	1/5
051144-05030-7	80		
051144-05029-1	100		
051144-05028-4	120		
051144-05027-7	150		
051144-05026-0	180		
051144-05025-3	220		
051144-05024-6	240		
051144-05022-2	320		
051144-05021-5	400		
051144-05020-8	500	2" x 50 yds.	
051144-05050-5	80		
051144-05049-9	100		
051144-05048-2	120		
051144-05047-5	150		
051144-05046-8	180		
051144-05045-1	220		
051144-05044-4	240		
051144-05042-0	320		
051144-05041-3	400		
051144-05040-6	500		

See pages 72–77 for available accessories.

Utility Cloth Sheets and Rolls (cont.)

3M™ Utility Cloth Sheets and Rolls 314D

- Aluminum oxide on X and J wt. cloth backings
- Ideal for all utility jobs
- Can be torn into strips and rolled without shelling

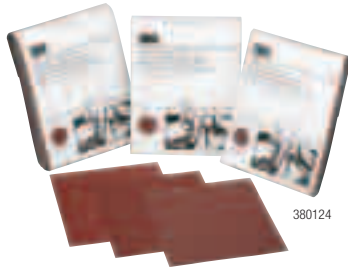

UPC	Grade	Backing	W x L	Min./Case
Sheets				
051115-19775-8	P40	X wt.	9" x 11"	50/250
051115-19774-1	P50			
051115-19773-4	P60			
051115-19772-7	P80	J wt.		
051115-19771-0	P100			
051115-19770-3	P120			
051115-19769-7	P150			
051115-19768-0	P180			
051115-19767-3	P220			
051115-19766-6	P240			
051115-19765-9	P280	P320		
051115-19764-2	P320			
051115-19763-5	P400			
Utility Rolls				
051115-19794-9	P50	X wt.	1" x 50 yds.	1/5
051115-19793-2	P60	J wt.		
051115-19792-5	P80			
051115-19791-8	P100	J wt.		
051115-19790-1	P120			
051115-19789-5	P150			
051115-19788-8	P180			
051115-19787-1	P220			
051115-19786-4	P240			
051115-19785-7	P280			
051115-19784-0	P320			
051115-19783-3	P400			

3M™ Utility Cloth Sheets and Rolls 314D (cont.)

UPC	Grade	Backing	W x L	Min./Case
Utility Rolls				
051115-19813-7	P50	X wt.	1-1/2" x 50 yds.	1/5
051115-19812-0	P60			
051115-19811-3	P80	J wt.		
051115-19810-6	P100			
051115-19809-0	P120			
051115-19808-3	P150			
051115-19807-6	P180			
051115-19806-9	P220			
051115-19805-2	P240			
051115-19804-5	P280			
051115-19803-8	P320	X wt.	2" x 50 yds.	
051115-19802-1	P400			
051115-19826-7	P40			J wt.
051115-19825-0	P50			
051115-19824-3	P60			J wt.
051115-19823-6	P80			
051115-19822-9	P100			
051115-19821-2	P120			
051115-19820-5	P150			
051115-19819-9	P180			
051115-19818-2	P220			
051115-19817-5	P240			
051115-19816-8	P280			
051115-19815-1	P320			
051115-19814-4	P400			

See pages 72–77 for available accessories.

3M™ Wetordry™ Sheets

Still a favorite for their reduced clogging, long life and great finish. Good general use sheet for hand or machine sanding. Can be run wet or dry.

3M™ Wetordry™ Sheet Selection Guide

Product ID	Mineral	Backing	Blending	Finishing
431Q	Silicon Carbide	C wt. Paper	●	
413Q		A wt. Paper		●

3M™ Wetordry™ Sheets 413Q

- Silicon carbide on an A wt. paper backing
- Reduced clogging eliminates dust when used wet
- Excellent conformability



UPC	Grade	W x L	Min./Case
051144-02007-2	220	9" x 11"	50/500
051144-02006-5	240		50/250
051144-02005-8	280		50/500
051144-02004-1	320		50/250
051144-02003-4	360		50/500
051144-02002-7	400		50/500

3M™ Wetordry™ Paper Sheets 431Q

- Silicon carbide on a C wt. paper backing
- Reduced clogging eliminates dust when used wet
- Heavyweight paper backing for increased durability



UPC	Grade	W x L	Min./Case
051144-02018-8	80	9" x 11"	50/250
051144-02017-1	100		
051144-02016-4	120		
051144-02015-7	150		
051144-02014-0	180		

3M™ Paper Sheets

Conformable and versatile, 3M™ Paper Sheets are ideal for hand or machine sanding. Various constructions available for use on wood, metal, paint, plastic and fiberglass.

3M™ Paper Sheet Selection Guide

	Product ID	Mineral	Backing	Blending	Finishing
Good	210N	Aluminum Oxide	A wt. Paper		●
Better	336U	Aluminum Oxide	C wt. Paper	●	
Best	346U	Aluminum Oxide	D wt. Paper	●	

3M™ Paper Sheets 210N

- Aluminum oxide on an A wt. paper backing
- Open Coat
- Provides exceptional conformability for contour sanding



UPC	Grade	W x L	Min./Case
051144-02104-8	180	9" x 11"	100/1000
051144-02103-1	220		

3M™ Paper Sheets 336U

- Aluminum oxide on a C wt. paper backing
- Medium-weight sheets for general-purpose sanding
- Open coat resists loading on soft materials

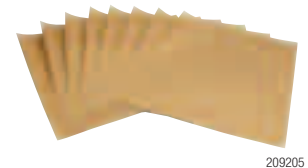

UPC	Grade	W x L	Min./Case
051144-02114-7	100	9" x 11"	100/1000
051144-02113-0	120		
051144-02112-3	150		

3M™ Paper Sheets 346U

- Aluminum oxide on a D wt. paper backing
- Ideal for hand or machine sanding of many different materials, including woods, metals, paints, plastics and fiberglass

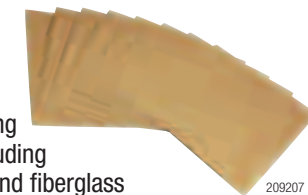

UPC (051144-)	Grade	W x L	Min./Case
051144-02119-2	36	9" x 11"	50/250
051144-02118-5	40		
051144-02117-8	50		50/500
051144-02116-1	60		
051144-02115-4	80		

See pages 72–77 for available accessories.

3M™ Flap Wheels

Coated Abrasive flap wheels are the ideal choice for light grinding, blending, graining and scale removal on a variety of metals. The abrasive flaps offer a long lasting supply of fresh abrasives and a load resistant design. Available in both flange mounted and spindle mounted constructions with general purpose aluminum oxide or high performing 3M™ Ceramic Aluminum Oxide blend abrasive grain.

3M™ Flange Mounted Flap Wheel Selection Guide

	Material	Product ID	Mineral	Grade
Better	Carbon Steel	241E	Aluminum Oxide	50-320
		244E	Aluminum Oxide	60-120
Best	Stainless Steel	741A	Ceramic Aluminum Oxide Blend	50-120

3M™ Flange Mounted Flap Wheels

3M™ Flap Wheels 241E/244E

- Aluminum oxide on a flexible XE wt. cloth backing
- Long life and fast cut
- General purpose flap wheels at a value price

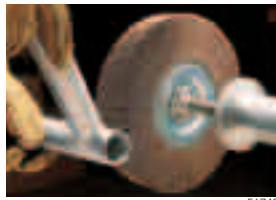

51742

UPC	Grade	Max. RPM	Dia. x W x AH	Qty./Case
051144-35113-8	60	6,100	6" x 1" x 1"	5
051144-35112-1	80			
051144-35111-4	100			
051144-35109-1	120			
051144-35088-9	60	5,200	6" x 2" x 1"	
051144-35086-5	80			

Additional sizes are available.

3M™ Flap Wheels 741A

- 3M™ Ceramic Aluminum Oxide blend abrasive grain on a durable X wt. cloth backing
- Longer life and faster cut

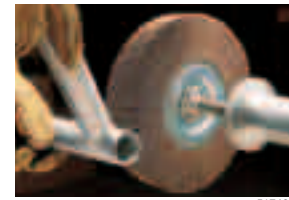

51742

UPC	Grade	Max. RPM	Dia. x W x AH	Qty./Case
051144-82770-1	50	6,100	6" x 1" x 1"	5
051144-81986-7	60			
051144-81984-3	80			

Additional sizes are available.

3M™ Flap Wheels 241E/244E and 741A can be made-to-order in the following sizes:

Diameter	Arbor Hole
> 3" – 4-1/2"	5/8"
> 4-1/2" – 6"	1"
> 6" – 8"	1" or 1-1/4"
> 8" – 10"	1-3/4" or 2"

See pages 72–77 for available accessories.



524290



T83 — 1/4" Straight



T84 — 1/4" x 20 Threaded

3M™ Spindle Mounted Flap Wheel Selection Guide

	Material	Product ID	Mineral	Grade
Better	Carbon Steel	244D	Aluminum Oxide	60-120
Best	Stainless Steel	747D	Ceramic Aluminum Oxide Blend	36-150

3M™ Spindle Mounted Flap Wheels

3M™ Flap Wheels 244D — T83 and T84

- Aluminum oxide
- General purpose flap wheel delivers consistent finish and uniform cut



UPC	Grade	Max. RPM	Dia. x W x Shk	Qty./Case
T83; 1/4" Straight				
051144-35475-7	60	30,000	1" x 1" x 1/4"	10
051144-35476-4	80			
051144-35477-1	120			
051144-14623-9	60	25,000	2" x 1" x 1/4"	
051144-14624-6	80			
051144-14625-3	120			
051144-14655-0	60	20,000	3" x 1" x 1/4"	
051144-14656-7	80			
051144-14657-4	120			
T84; 1/4-20 Threaded				
051144-35467-2	60	30,000	1" x 1" x 1/4-20 EXT	10
051144-35468-9	80			
051144-35469-6	120			
051144-14575-1	60	25,000	2" x 1" x 1/4-20 EXT	
051144-14576-8	80			
051144-14607-9	60			
051144-14608-6	80	20,000	3" x 1" x 1/4-20 EXT	

3M™ Flap Wheels 747D — T83 and T84

- 3M™ Ceramic Aluminum Oxide blend abrasive grain on a resin-bonded X wt. cloth backing
- Includes a grinding aid for cooler running on stainless steel



UPC	Grade	Max. RPM	Dia. x W x Shk	Qty./Case
T83; 1/4" Straight				
051144-80761-1	60	30,000	1" x 1" x 1/4"	10
051144-80757-4	80			
051144-80753-6	P120			
051144-80763-5	60	25,000	2" x 1" x 1/4"	
051144-80759-8	80			
051144-80755-0	P120			
051144-80650-8	60	20,000	3" x 1" x 1/4"	
051144-80651-5	80			
051144-80652-2	P120			
T84; 1/4-20 Threaded				
051144-83271-2	60	25,000	2" x 1" x 1/4-20 EXT	10
051144-83268-2	80			
051144-83265-1	P120			
051144-83269-9	60	20,000	3" x 1" x 1/4-20 EXT	
051144-83267-5	80			
051144-83263-7	P120			

See pages 72-77 for available accessories.

3M™ Cartridge Rolls

Cartridge rolls are ideal for getting into small, hard to reach spaces. As they wear, the wrapped layers of the cartridge roll continuously expose fresh abrasive layers for continued cutting action. Available in regular and tapered construction.

3M™ Cartridge Rolls 341D

- Aluminum oxide on an X wt. cloth backing
- Long life and fast cut
- General purpose cartridge rolls at a value price



51754

UPC	Grade	Max. RPM	Dia. x L x CH	Qty./Case
Regular				
051144-96959-3	P60	24,000	1/4" x 1" x 1/8"	100
051144-14021-3	P80			
051144-96961-6	P120			
051144-96963-0	P180			
051144-96968-5	P60			
051144-96969-2	P80			
051144-96971-5	P120		1/4" x 1-1/2" x 1/8"	
051144-96973-9	P180			
051144-14024-4	P60			
051144-14023-7	P80			
051144-14022-0	P120			
051144-97008-7	P180			
051144-97013-1	P60			
051144-20417-8	P80			
051144-97015-5	P120			
051144-97017-9	P180			
051144-97041-4	P60		3/8" x 1-1/2" x 1/8"	
051144-97042-1	P80			
051144-97044-5	P120			
051144-14028-2	P60			
051144-14027-5	P80			
051144-14026-8	P120	1/2" x 1" x 1/8"		
051144-97059-9	P180			
051144-97162-6	P60		1/2" x 1-1/2" x 1/8"	
051144-97163-3	P80			
051144-97165-7	P120			
				16,000



3M™ Cartridge Rolls 341D (cont.)

UPC	Grade	Max. RPM	Dia. x L x CH	Qty./Case	
Full Taper					
051144-97239-5	P60	24,000	3/8" x 1" x 1/8"	100	
051144-97240-1	P80				
051144-97242-5	P120				
051144-97244-9	P180				
051144-97248-7	P60		3/8" x 1-1/2" x 1/8"		
051144-97249-4	P80				
051144-97251-7	P120				
051144-97257-9	P60				1/2" x 1" x 1/8"
051144-97259-3	P120				
051144-14034-3	P60		1/2" x 1-1/2" x 1/8"		
051144-14033-6	P80				
051144-14032-9	P120				
051144-97267-8	P180				

3M™ Cartridge Rolls 747D

- 3M™ Ceramic Aluminum Oxide blend abrasive grain on an X wt. cloth backing
- Long life and fast cut
- Contains grinding aid for cooler cutting on heat sensitive alloys



14378

UPC	Grade	Max. RPM	Dia. x L x CH	Qty./Case
Regular				
051144-80790-1	60	24,000	1/2" x 1-1/2" x 1/8"	100
051144-80796-3	80			
051144-80792-5	P120			
Full Taper				
051144-80786-4	60	24,000	1/2" x 1-1/2" x 1/8"	100
051144-80787-1	80			
051144-80788-8	P120			

See pages 72–77 for available accessories.

3M™ Square and Cross Pads

Square pads are ideal for fast grinding/blending of channels, fillets, and corners, plus spotting on flat surfaces. As the square pads rotate, the corners exert a fast biting action and gradually wear down to expose fresh abrasive material.

Cross pads are used for close tolerance polishing of small radii and channels, deburring the ends and insides of tubing, and other special applications.

3M™ Square Pads 341D

- Premium aluminum oxide on an X wt. cloth backing
- Long life and fast cut
- General purpose square pads at a value price



UPC	Grade	Max RPM	Size	Min./Case
1/4"– 20 Eyelet				
051141-27353-2†	60	12,000	2" x 2" x 3/8"	50/100
051141-27354-9†	80			
051141-27355-6†	P120		2" x 2" x 1/2"	
051141-27350-1	60			
051141-27351-8	80	9,000	3" x 3" x 1/4"	
051141-27352-5	P120			
051144-97723-9		9,000	3" x 3" x 1/2"	
051141-27356-3†	60			
051141-27357-0†	80			
051141-27358-7†	P120			

† Made-to-Order

3M™ Square Pads 747D

- 3M™ Ceramic Aluminum Oxide blend abrasive grain on an X wt. cloth backing
- Super aggressive cut rate and durability
- Contains grinding aid for cooler cutting on heat sensitive alloys



UPC	Grade	Max RPM	Size	Qty./Case
1/4"– 20 Eyelet				
051141-27359-4†	60	12,000	2" x 2" x 1/2"	100
051141-27360-0†	80			
051141-27361-7†	P120		2" x 2" x 3/8"	
051141-27362-4†	60			
051141-27363-1†	80	9,000	3" x 3" x 1/2"	
051141-27364-8†	P120			
051141-27365-5†	60			
051141-27366-2†	80			
051141-27367-9†	P120			

† Made-to-Order

3M™ Cross Pads 341D

- Premium aluminum oxide on an X wt. cloth backing
- Long life and fast cut
- General purpose square pads at a value price



UPC	Grade	Max RPM	Size	Min./Case	
8 or 10 Ply; 8"– 32 Eyelet					
051141-27368-6	60	24,000	1" x 1" x 3/8"	50/100	
051141-27369-3	80				
051141-27370-9†	P120		1-1/2" x 1-1/2" x 1/2"		
051141-27371-6	60				
051141-27372-3	80				
051141-27373-0	P120				
10 Ply; 8"– 32 Eyelet					
051141-27374-7	60	18,000	2" x 2" x 1/2"		50/100
051141-27375-4	80				
051141-27376-1	P120		2" x 2" x 3/4"		
051141-27377-8	60				
051141-27378-5	80				
051141-27379-2	P120		2-1/2" x 2-1/2" x 3/4"		
051144-97750-5	60				
8 or 10 Ply; 1/4"– 20 Eyelet					
051141-27380-8	60	18,000	3" x 3" x 1"	50/100	
051141-27381-5	80				
051141-27382-2†	P120		3" x 3" x 1-1/2"		
051144-97760-4	60				
051144-97766-6	80	15,000	3-1/2" x 3-1/2" x 1-1/2"		
051144-97768-0		12,000	4" x 4" x 1"		
051144-98880-2	60	10,000	5" x 5" x 1-1/2"		
051144-97783-3		9,000	6" x 6" x 1-1/2"		

† Made-to-Order

3M™ Cross Pads 747D

- 3M™ Ceramic Aluminum Oxide blend abrasive grain on an X wt. cloth backing
- Super aggressive cut rate and durability
- Contains grinding aid for cooler cutting on heat sensitive alloys



UPC	Grade	Max RPM	Size	Qty./Case
8 Ply; 1/4"– 20 Eyelet				
051141-20368-3	60	24,000	1-1/2" x 1-1/2" x 1/2"	100
051141-20369-0	80			
051141-20372-0	P100			
051141-20379-9	P120			
051141-20380-5	60	18,000	2" x 2" x 1/2"	
051141-20367-6	P100			
051141-20375-1	80		2" x 2" x 3/4"	

† Made-to-Order

See pages 72–77 for available accessories.

3M™ Bands

Great for getting at those hard to reach places and contours. Ideal for removing parting lines, imperfections and burrs. Use with 3M™ Die Grinders and 3M™ Rubber Slotted Expander Wheel or 3M™ Rubber Cushion Polishing Wheel.

3M™ Bands 341D

- Aluminum oxide on and X wt. cloth backing
- Fast cut and long life
- General purpose evenrun bands at a value price



UPC	Grade	Max. RPM	Dia. x W	Qty./Case
051144-40243-4	P80	23,000	1/4" x 1/2"	100
051144-97428-3	P120			
051144-27446-7	P36			
051144-40228-1	P60	30,000	1/2" x 1/2"	
051144-40227-4	P80			
051144-40252-6	P120			
051144-97458-0	P36			
051144-40225-0	P60	15,000	1/2" x 1"	
051144-40224-3	P80			
051144-11973-8	P120			
051144-11976-9	P36	17,000	3/4" x 1"	
051144-40221-2	P60			
051144-40220-5	P80			
051144-40219-9	P120			
051144-11977-6	P36	10,000	3/4" x 1-1/2"	
051144-40241-0	P80			
051144-40214-4	P36	18,000	1" x 1"	
051144-40211-3	P60			
051144-40210-6	P80			
051144-40208-3	P120			
051144-40207-6	P36	10,000	1" x 1-1/2"	
051144-11980-6	P60			
051144-40205-2	P80			
051144-40203-8	P36	14,000	1-1/2" x 1"	
051144-40202-1	P60			
051144-40200-7	P36	10,000	1-1/2" x 1-1/2"	
051144-40197-0	P60			
051144-40196-3	P80			
051144-40274-8	P120			

3M™ Bands 341D (cont.)

UPC	Grade	Max. RPM	Dia. x W	Qty./Case
051144-40267-0	P60	8,000	1-1/2" x 2"	
051144-40192-5	P60	11,000	2" x 1"	
051144-40187-1	P36	6,000	2" x 2"	
051144-40184-0	P60			
051144-40183-3	P80	3,000	3" x 3"	50
051144-40178-9	P36			
051144-40175-8	P60			
051144-40174-1	P80			
051144-40172-7	P120			

3M™ Bands 747D

- 3M™ Ceramic Aluminum Oxide blend abrasive grain on an X wt. cloth backing
- Long life and fast cut
- Contains grinding aid for cooler cutting on heat sensitive alloys



UPC	Grade	Max. RPM	Dia. x W	Qty./Case
051144-80765-9	50	15,000	1/2" x 1"	100
051144-80769-7	60			
051144-80773-4	80			
051144-80766-6	50	18,000	1" x 1"	
051144-80770-3	60			
051144-80774-1	80			
051144-80782-6	P120			
051144-80771-0	60	11,000	2" x 1"	
051144-80775-8	80			
051144-80783-3	P120			

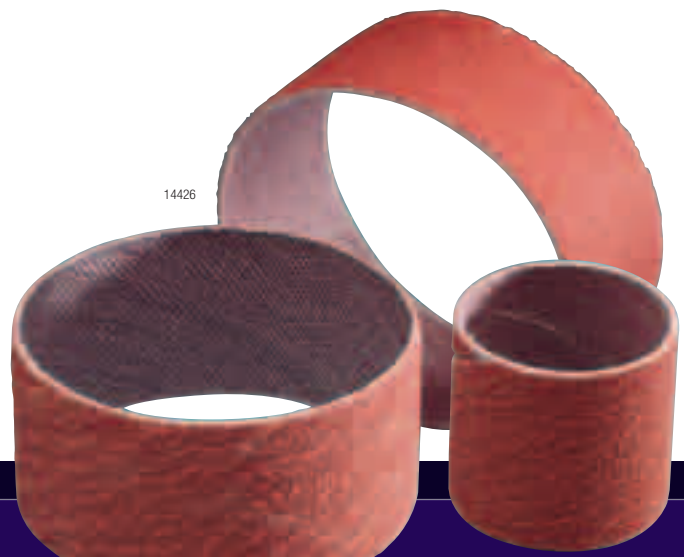

See pages 72–77 for available accessories.

Scotch-Brite™ Discs























Make tough jobs easier. Scotch-Brite™ Discs can help you achieve a burr-free, paintable finish in fewer steps without damaging the base material. The non-woven, open web, durable construction is designed to resist loading and greatly increase the life of the disc. As a result, you will not have to change it as often. However, when you do change your disc, the Roloc™ attachment or Hook-and-Loop attachment makes it fast and easy.

Scotch-Brite™ Disc Selection Guide

	Light Grinding	Blending	Deburring	Finishing	Cleaning	Coating Removal
Increased Loading Resistance	SC, PD	SC, PD	SC	PD, HS, C&F	Bristle, HS, C&F	Bristle, HS
Starting Point	SL	SL	SE	SC	PD	C&S
Increased Wear Resistance	LGB	LGB	LGB	SL	SC	C&S XT

Legend					
PD	PD Surface Conditioning Discs	SE	SE Surface Conditioning Discs	C&F	Clean and Finish Discs
LGB	Light Grinding and Blending Discs	SL	SL Surface Conditioning Discs	C&S	Clean and Strip Discs
SC	SC Surface Conditioning Discs	HS	High Strength Discs	C&S XT	Clean and Strip XT Discs

Scotch-Brite™ Disc Attachment Guide

	Attachments			
PD Surface Conditioning Discs				
	Roloc™ TR	Hook-and-Loop		
SC Surface Conditioning Discs				
	Roloc™ TR	Roloc™ TP	Roloc™ TSM	Hook-and-Loop
SE Surface Conditioning Discs				
	Roloc™ TR	Hook-and-Loop		
SL Surface Conditioning Discs				
	Roloc™ TR	Hook-and-Loop	TN Quick Change	
Light Grinding & Blending Discs				
	Roloc™ TR	Hook-and-Loop	TN Quick Change	
Bristle Discs				
	TN Quick Change			
Clean & Finish Discs				
	Hookit™			
Clean & Strip Discs				
	Spindle Mount			
Clean & Strip XT Discs				
	TN Quick Change	Roloc™ TR		
High Strength Discs				
	Spindle Mount	Roloc™ TP	Roloc™ TSM	

Roloc™ TR, TP, TS and TSM are plastic button attachments

See pages 72–77 for available accessories.



Scotch-Brite™ Roloc™ Discs

Scotch-Brite™ Roloc™ SC Surface Conditioning Discs

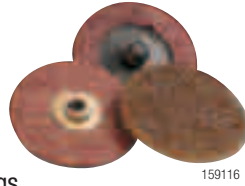
- Scotch-Brite surface conditioning non-woven web provides a burr-free decorative finish
- Removes grind marks, rust and coatings
- Grade: A VFN – Blue; A MED – Maroon; A CRS – Brown



159116

UPC	Grade	Max. RPM	Diameter	Min./Case
Roloc TP (Metal Button) 				
048011-13237-2	A CRS	25,000	2"	50/200
048011-13241-9		18,000	3"	25/100
048011-13243-3†	A VFN			
Roloc TR (Plastic Button) 				
048011-15393-3	A CRS	30,000	1"	200
048011-15392-6	A MED			
048011-15391-9	A VFN			
048011-15568-5†	A SFN	25,000	1-1/2"	50/200
048011-08764-1	A CRS			
048011-08765-8	A MED			
048011-08766-5	A VFN			
048011-08767-2†	A SFN			
048011-05528-2	A CRS			
048011-05527-5	A MED	18,000	2"	25/100
048011-05522-0	A SFN			
048011-05523-7	A VFN			
048011-05532-9	A CRS	12,000	3"	25/100
048011-05531-2	A MED			
048011-05529-9	A SFN			
048011-05530-5	A VFN			
048011-12954-9	A CRS			
048011-12953-2	A MED			
048011-12951-8†	A SFN	100	4"	25/100
048011-12952-5	A VFN			
Roloc TSM (Metal Button) 				
048011-13249-5†	A CRS	30,000	1-1/2"	50/200
048011-25775-4	A MED			
048011-25774-7†	A VFN			
048011-25773-0†	A CRS	25,000	2"	25/100
048011-25765-5	A MED			
048011-25764-8	A VFN			
048011-25770-9	A CRS	18,000	3"	25/100
048011-25767-9	A MED			
048011-13257-0	A VFN			
048011-25766-2	A SFN			
048011-13258-7	A CRS			
048011-25780-8	A MED			
048011-13259-4	A VFN	100	4"	25/100
048011-13260-0†	A SFN			

† Made-to-Order

See pages 72–77 for available accessories.

Compare Performance Options for Scotch-Brite™ Surface Conditioning Discs

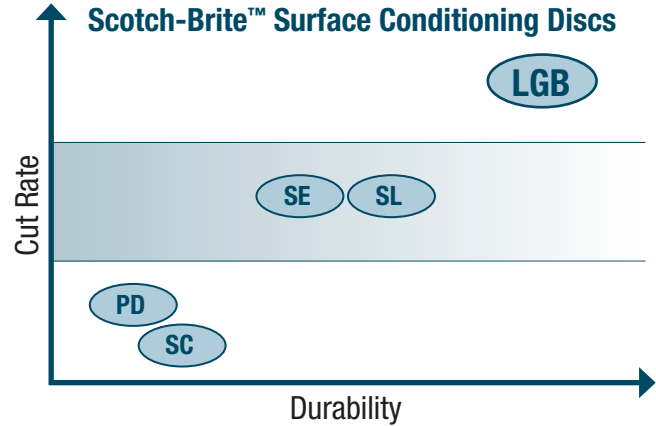

Scotch-Brite™ Roloc™ SE Surface Conditioning Discs

- This coarse, tough, aggressive non-woven disc is ideal for heavy-duty deburring and finishing

UPC	Grade	Max. RPM	Diameter	Min./Case
Roloc TR (Plastic Button) 				
048011-18081-6	A CRS	25,000	2"	50/200
048011-18471-5	A MED			
048011-30005-4	A FIN			
048011-18082-3	A CRS	18,000	3"	25/100
048011-18472-2	A MED			
048011-93453-2	A FIN			

Scotch-Brite™ Roloc™ SL Surface Conditioning Discs

- Cuts fast without sacrificing finish
- Can last up to twice as long as other surface conditioning discs
- Delivers outstanding value and productivity improvement



525694

473201

UPC	Grade	Max. RPM	Diameter	Min./Case
Roloc TR (Plastic Button) 				
048011-33797-5	A CRS SD	25,000	2"	200
048011-33795-1	A CRS HD			50/200
048011-33793-7	A CRS			
048011-33791-3	A MED	18,000	3"	100
048011-33796-8	A CRS SD			
048011-33794-4	A CRS HD			
048011-33792-0	A CRS			
048011-33790-6	A MED			

Many other sizes available upon request.

Scotch-Brite™ Roloc™ Discs (cont.)

Scotch-Brite™ Roloc™ Light Grinding and Blending Discs

- 3M™ Ceramic Aluminum Oxide blend abrasive grain
- Resists edge wear
- Great for light grinding, deburring and blending on all metals



UPC	Grade	Max. RPM	Diameter	Qty./Case
Roloc TR (Plastic Button)				
048011-60355-1	A CRS SD	25,000	2"	50/200
048011-60354-4	A CRS HD			
048011-60357-5	A CRS SD	18,000	3"	25/100
048011-60356-8	A CRS HD			
048011-60359-9	A CRS SD	12,000	4"	
048011-60358-2	A CRS HD			
Roloc TSM (Metal Button)				
048011-60375-9	A CRS SD	25,000	2"	50/200
048011-60374-2	A CRS HD			
048011-60377-3	A CRS SD	18,000	3"	100
048011-60376-6†	A CRS HD			

† Made-to-Order

Scotch-Brite™ Roloc™ PD Surface Conditioning Discs

- Lofty, open non-woven abrasive disc
- Resistant to loading on soft metals and oily surfaces

UPC	Grade	Max. RPM	Diameter	Min./Case
Roloc TR (Plastic Button)				
048011-60191-5†	A CRS	25,000	2"	50/200
048011-24287-3	A MED			
048011-60192-2	A CRS	18,000	3"	25/100
048011-24295-8	A MED			

† Made-to-Order

Scotch-Brite™ Roloc™ Clean and Strip Discs

- Aggressively removes paint, rust and seam sealers
- Open web construction for cool running and resistance to loading and smearing
- Faster cutting than wire brushes and wheels to increase production



UPC	Grade	Max. RPM	Size	Qty./Case
048011-14784-0	S XCS	8,000	4" x 1"	10
048011-14780-2			4" x 1" x 1/4"	

524494

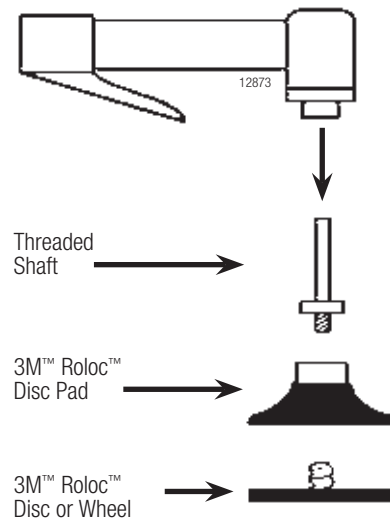

See pages 72–77 for available accessories.

Scotch-Brite™ Roloc™ Discs (cont.)

Scotch-Brite™ Roloc™ Clean and Strip XT Disc

- Silicon carbide mineral
- Durable, rigid, long lasting
- Aggressive, open-web disc for cleaning welds, removing rust and paint



524504

UPC	Grade	Max. RPM	Diameter	Min./Case
Roloc TR (Plastic Button)				
048011-30147-1	S XCS	18,000	2" x NH	60
048011-30016-0		15,000	3" x NH	40

Scotch-Brite™ Roloc™ HS Blend and Finish

- Aluminum oxide mineral
- New high strength nonwoven with superior durability and cut
- Great flexibility and conformability for weld burn removal, light deburring, blending, finishing and rust removal

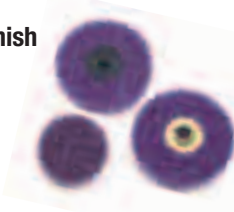

UPC	Grade	Max. RPM	Diameter	Min./Case
Roloc TR (Plastic Button)				
048011-64190-4	A MED	18,000	2"	200
048011-64206-2		15,000	3"	100
Roloc TSM (Metal Button)				
048011-64213-0	A MED	18,000	2"	200
048011-64220-8		15,000	3"	100

Scotch-Brite™ Roloc™ Bristle Discs

- Efficiently clean and strip many substances from metal surfaces without damaging the work piece
- An operator can quickly and easily achieve a quality, consistent finish with light pressure



431922

UPC	Grade	Color	Max. RPM	Size	Min./Case
Roloc TR (Plastic Button)					
048011-18698-6	50	Green	30,000	1"	20/80
048011-18706-8	80	Yellow			
048011-18710-5	120	White			
048011-18730-3	50	Green	25,000	2"	10/40
048011-18732-7	80	Yellow			
048011-18733-4	120	White			
048011-18734-1	50	Green	15,000	3"	10/40
048011-18736-5	80	Yellow			
048011-18737-2	120	White			

Scotch-Brite™ Roloc™ Body Man's Bristle Disc

- Contains 3M™ Ceramic Aluminum Oxide blend abrasive grain
- Removes high loading materials fast and doesn't load
- Great for removing rubberized undercoating, seam sealer, rust and paint
- Maintains high quality product life

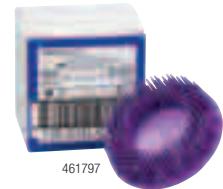

461797

UPC	Grade	Max. RPM	Diameter	Min./Case
051131-07540-5	36	30,000	1"	6/36
051131-07536-8		25,000	2"	4/24
051131-07537-5		18,000	3"	3/18

Scotch-Brite™ Roloc™ Coating Removal Discs

- Extra coarse grade silicon carbide
- Heavy duty, semi-open web used to clean rust and paint
- Color: Black



UPC	Grade	Max. RPM	Diameter	Qty./Case
048011-18364-0	S XCS	18,000	2"	60
048011-18350-3		15,000	3"	40
048011-18470-8		11,000	4"	

Scotch-Brite™ Roloc™ EXL Unitized Wheels

- Strong, efficient products for edge deburring and finishing
- Used with 3M™ Roloc™ or 3M™ Roloc™+ holder pads on a straight shaft or right-angle tool

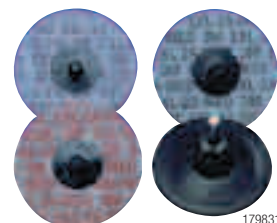

179831

UPC	Grade	Max. RPM	Size	Qty./Case
Roloc TR (Plastic Button)				
048011-17185-2	2A MED	22,100	2"	60
048011-17183-8	2S FIN			
048011-17190-6	6A MED			
048011-17192-0	8A MED	15,100	3"	40
048011-17186-9	2A MED			
048011-17184-5	2S FIN			
048011-17191-3	6A MED			
048011-17193-7	8A MED			

See pages 72–77 for available accessories.

Scotch-Brite™ Discs — Hook-and-Loop

Scotch-Brite™ SC Surface Conditioning Discs (Hook-and-Loop)

- Aluminum oxide
- Great general purpose surface conditioning disc
- For finishing, cleaning, and light deburring
- Attach and remove easily to 3M™ Hook-and-Loop Backup Pads
- Use with right angle and random orbital tools

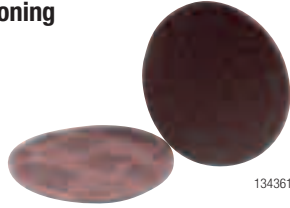

UPC	Grade	Color	Max. RPM	Diameter	Min./Case
Hook-and-Loop					
048011-07458-0	A CRS	Brown	23,000	2"	50/200
048011-07459-7	A MED	Maroon			
048011-04276-3	A VFN	Blue			
048011-04127-8†	A SFN	Gray			
048011-04120-9	A CRS	Brown	20,000	3"	25/100
048011-04124-7	A MED	Maroon			
048011-04277-0	A VFN	Blue			
048011-04129-2	A SFN	Gray			
048011-07450-4	A CRS	Brown	13,000	4"	100
048011-07451-1	A MED	Maroon			
048011-04278-7	A VFN	Blue			
048011-04129-2	A SFN	Gray			
048011-14101-5	A CRS	Brown	10,000	4-1/2"	50
048011-27671-7	A CRS	Brown			10
048011-27672-4	A MED	Maroon			50
048011-14100-8	A MED	Maroon			50
048011-14099-5	A VFN	Blue	10,000	5"	50
048011-14102-2	A SFN	Gray			
048011-27674-8	A CRS	Brown			
048011-00750-2	A CRS	Brown			
048011-27675-5	A MED	Maroon	8,000	6"	50
048011-00643-7	A MED	Maroon			
048011-27676-2	A VFN	Blue			
048011-04303-6	A VFN	Blue			
048011-00647-5	A SFN	Gray	8,000	6"	50
048011-03927-5	A CRS	Brown			
048011-03928-2	A MED	Maroon			
048011-04304-3	A VFN	Blue			

† Made-to-Order

Scotch-Brite™ SC Surface Conditioning Discs (Hook-and-Loop) (cont.)

UPC	Grade	Color	Max. RPM	Diameter	Min./Case		
Hook-and-Loop							
048011-27677-9	A CRS	Brown	6,000	7"	10		
048011-00751-9					25		
048011-27678-6	A MED	Maroon			10		
048011-00645-1					25		
048011-27679-3	A VFN	Blue		8"	10		
048011-04305-0					25		
048011-00648-2	A SFN	Gray			600	48"	2
048011-00752-6	A CRS	Brown					
048011-00670-3	A MED	Maroon					
048011-04306-7	A VFN	Blue					
048011-00649-9†	A SFN	Gray					
048011-13325-6†	A CRS	Brown					
048011-13100-9†	A MED	Maroon					
048011-13099-6†	A VFN	Blue					
048011-18385-5†	A SFN	Gray					

† Made-to-Order

Scotch-Brite™ SE Surface Conditioning Discs (Hook-and-Loop)

- High cutting surface conditioning disc great for edge deburring applications

UPC	Grade	Max. RPM	Diameter	Min./Case
Hook-and-Loop				
048011-18021-2	A CRS	13,000	4"	100
048011-18475-3†	A MED		4-1/2"	50
048011-18079-3	A CRS			
048011-18476-0	A MED			
048011-18080-9	A CRS	10,000	5"	25
048011-18919-2†	A MED			
048011-17866-0	A CRS	6,000	7"	2
048011-18477-7	A MED			
048011-30003-0†	A FIN			
048011-17239-2	A CRS			
048011-93348-1†	A CRS	600	48"	2
048011-60392-6†	A FIN			

† Made-to-Order



See pages 72–77 for available accessories.

Scotch-Brite™ Discs — Hook-and-Loop (cont.)

Scotch-Brite™ SL Surface Conditioning Discs (Hook-and-Loop)

- Aluminum oxide
- Highly durable product for aggressive applications
- Cuts fast without sacrificing finish and can work twice as long as other standard surface conditioning discs

UPC	Grade	Max. RPM	Diameter	Qty./Case
048011-33813-2†	A CRS SD	13,000	4"	100
048011-33810-1†	A CRS HD			
048011-33807-1†	A CRS			25/100
048011-33804-0†	A MED	10,000	4-1/2"	100
048011-33814-9	A CRS SD			
048011-33811-8	A CRS HD			
048011-33808-8	A CRS			50
048011-33805-7	A MED			
048011-33815-6†	A CRS SD			
048011-33812-5†	A CRS HD	6,000	5"	25
048011-33806-4†	A CRS HD			
048011-33809-5†	A MED			
048011-33789-0	A CRS SD			25
048011-33788-3	A CRS HD			
048011-33787-6	A CRS			
048011-33786-9	A MED			

† Made-to-Order

Scotch-Brite™ Clean and Finish Discs (Hook-and-Loop)

- Flexible web for finishing, blending and polishing
- Conformability allows access to hard-to-reach areas



UPC	Grade	Max. RPM	Diameter	Qty./Case
048011-16001-6	A VFN	5,000	5"	100
048011-00661-1		4,000	6"	
048011-30037-5		1,900	11-1/4"	25

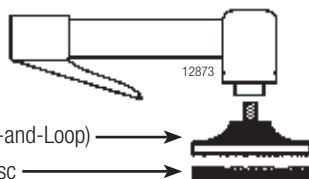

3M™ Disc Holder (Hook-and-Loop)

Surface Conditioning Disc

Scotch-Brite™ Light Grinding and Blending Center Hole Disc (Hook-and-Loop)

- Durable, non-woven 3M™ Ceramic Aluminum Oxide blend abrasive grain product used for light grinding applications providing burr-free finish
- For use with the 3M™ Center Pin Backup Pad or 3M™ Fibre Disc Hubs, Face Plates and Retainer Nuts
- Super Duty: Blue
- Heavy Duty: Maroon

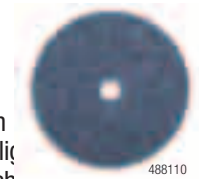

488110

UPC	Grade	Max. RPM	Dia. x Ctr. Hole	Min./Case
Center Hole				
048011-60363-6	A CRS SD	10,000	4-1/2"	50
048011-60333-9†			4-1/2" x 7/8"	
048011-60332-2†	A CRS HD	5"		
048011-60343-8	A CRS SD	6,000	5" x 7/8"	25
048011-60341-4	A CRS HD		7"	
048011-60336-0	A CRS HD	6,000	7" x 7/8"	
048011-60346-9	A CRS SD			
048011-60344-5	A CRS SD			
048011-60347-6	A CRS HD			
Hook-and-Loop				
048011-60335-3	A CRS HD	10,000	4-1/2"	50
048011-60342-1			5"	
048011-60345-2		6,000	7"	25

† Made-to-Order

Scotch-Brite™ Coating Removal Discs (Hook-and-Loop)

- Extra coarse grade silicon carbide
- Made for right-angle tools from aggressive Clean & Strip web
- Non-loading design ideal for removing rust and coatings
- Mount on Hook-and-Loop Disc Pad Holders



375428

UPC	Grade	Max. RPM	Diameter	Min./Case
Hook-and-Loop				
048011-18424-1	S XCS	12,000	4-1/2"	4/20
048011-18482-1*				40
048011-18355-8		10,000	5"	4/20
048011-18483-8*				40
048011-18358-9		6,000	7"	2/10
048011-18485-2*				20

* Bulk

See pages 72–77 for available accessories.

Scotch-Brite™ Discs — TN Quick Change

Scotch-Brite™ Light Grinding and Blending Discs TN Quick Change

- 3M™ Ceramic abrasive grain
- Aggressive, long life, Scotch-Brite finish
- Resistant to edge wear
- Super Duty: Blue
- Heavy Duty: Maroon

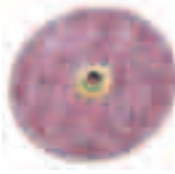

UPC	Grade	Max. RPM	Diameter x AH	Qty./Case
048011-60349-0	A CRS SD	13,000	4-1/2" x 5/8-11*	50
048011-60348-3	A CRS HD			
048011-60351-3	A CRS SD	12,000	5" x 5/8-11*	
048011-60350-6	A CRS HD			
048011-60353-7	A CRS SD	8,600	7" x 5/8-11*	25
048011-60352-0	A CRS HD			

* Quick Change Tinneman Nut Attachment

Scotch-Brite™ Clean and Strip XT Disc, TN Quick Change

- Extra coarse grade silicon carbide
- Mounts quickly to 4-1/2" and 7" grinders
- Tough open web, ideal for weld cleaning and removing paint and coatings
- Use with TN Quick Change back up pad or fibre disc hub and face plate



148243

UPC	Grade	Max. RPM	Dia. x Thk. X AH	Min./Case
048011-33194-2	S XCS	13,300	4-1/2" x 1/2" x 5/8-11*	10
048011-33196-6		8,600	7" x 1/2" x 5/8-11*	5

* Quick Change Tinneman Nut Attachment

Scotch-Brite™ Bristle Discs

- Easily remove paint, stains, adhesives, weld burn, rust and other surface contaminants from large areas



424848

UPC	Grade	Color	Max. RPM	Diameter x AH	Qty./Case
048011-33054-9	36	Brown	12,000	4-1/2" x 5/8-11 INT	10
048011-24241-5	50	Green			
048011-24242-2	80	Yellow			
048011-24243-9	120	White			



524496

Scotch-Brite™ Discs — Spindle Mount

Scotch-Brite™ High Strength Discs

- Aluminum oxide
- Very conformable discs, ideal for light deburring, cleaning and finishing

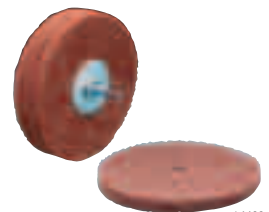

14463

UPC	Grade	Max. RPM	Dia. x Ctr. Hole	Min./Case
Use with Mandrel 933				
048011-05629-6†	A MED	4,000	6" x 1/4"	100
048011-27748-6	A VFN			10/40
048011-00666-6				100
Use with Mandrel 934				
048011-27745-5	A MED	4,000	6" x 1/2"	10/40
048011-04188-9				100
048011-27747-9	A VFN			10/40
048011-00665-9				100
048011-93477-8†	A MED	3,000	8" x 1/4"	50
048011-00673-4	A VFN			
048011-27746-2	A MED	3,000	8" x 1/2"	10/20
048011-03992-3				50
048011-27749-3	A VFN			10/20
048011-00672-7				50

† Made-to-Order

Scotch-Brite™ Clean and Strip Discs

- Extra coarse grade silicon carbide
- Tough open web, ideal for weld cleaning and removing paint and coatings



51717

UPC	Grade	Max. RPM	Dia. x Ctr. Hole	Qty./Case
Use with Mandrel 934				
048011-00941-4	S XCS	6,000	4" x 1/2"	25
048011-00948-3		4,000	6" x 1/2"	15
048011-00957-5		3,000	8" x 1/2"	

See pages 72-77 for available accessories.

Scotch-Brite™ Surface Conditioning Belts

The easiest way to a perfect finish. Choose Scotch-Brite™ Surface Conditioning Belts for cleaning, finishing, blending and deburring. The reinforced backing offers good flexibility whether working on a file belt or backstand. The non-woven material combined with abrasive grain is an ideal way to add a great finish or remove burrs without gouging or undercutting the work piece. Trust Scotch-Brite belts to deliver fantastic finishes.

Scotch-Brite™ Surface Conditioning Belt Selection Guide

		Blending	Deburring	Finishing	Cleaning
Stainless Steel, Carbon Steel, Titanium, Nickel Alloy	Good	SE	SC	SE	SE
	Better	SC	DF	SC	DF
	Best	DF	SE	DF	SC
A/L, Copper, Brass (Soft Metals), Non-Ferrous Metals	Good	SC	SC	SC	SC
	Better	DF	DF	DF	DF
	Best	PD	PD	PD	PD

Scotch-Brite™ Surface Conditioning Belt Availability Guide

3M ID	Backing	A CRS	A MED	A FIN	A VFN	SFN
DF	Low Stretch	●	●	●		
SC	Scrim	●	●		●	●
	Low Stretch	●	●		●	●
	Film Backed	●	●		●	●
SE	Scrim	●	●	●		
	Low Stretch	●	●	●		
	Film Backed	●	●			
PD	Scrim	●	●			
	Low Stretch	●				
	Film Backed	●				

Legend

DF	DF Surface Conditioning Belts	SC	SC Surface Conditioning Belts
PD	PD Surface Conditioning Belts	SE	SE Surface Conditioning Belts

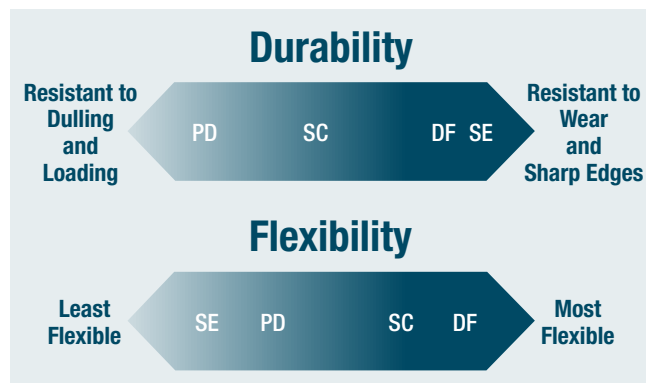

SCOTCH-BRITE™ BELTS RECOMMENDED OPERATING SPEEDS

Application	Recommended SFPM
Decorative Finishing	500–3,000 SFPM
Deburring	5,000–6,500 SFPM
Cleaning and Conditioning	2,000–5,000 SFPM
Oxide Removal	4,500–6,500 SFPM

Maximum Operating Speed: 6,500 SFPM
SFPM = Surface Feet Per Minute

ATTENTION: Belts are available in other grades and sizes. If you need a specific belt not listed, contact your 3M Sales Specialist or 3M Authorized Distributor.

See pages 72–77 for available accessories.

Scotch-Brite™ Surface Conditioning Belts (cont.)

Scotch-Brite™ SE Surface Conditioning Belt

- Coarse, tough, aggressive non-woven belt for heavy duty deburring and finishing
- Reinforced backing offers good flexibility
- Abrasive mineral: coarse grade aluminum oxide
- Color: Brown/blue

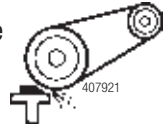

UPC	Grade	W x L	Qty./Case
Backstand			
048011-18495-1	A CRS	1/4" x 18"	20
048011-18496-8†		1/4" x 24"	
048011-18087-8		1/2" x 18"	
048011-18088-5		1/2" x 24"	
048011-19697-8		3/4" x 18"	
048011-18089-2		3-1/2" x 15-1/2"	

† Made-to-Order

Scotch-Brite™ SC Surface Conditioning Belts

- Premium Scotch-Brite™ surface conditioning non-woven web
- Designed for cleaning, finishing and light deburring



UPC	Grade	Color	W x L	Qty./Case
Portable, Benchtop and Backstand				
048011-13290-7†	A CRS	Brown	1/4" x 18"	20
048011-14276-0	A MED	Maroon		
048011-13230-3†	A VFN	Blue		
048011-13132-0	A CRS	Brown	1/4" x 24"	
048011-13131-3	A MED	Maroon		
048011-13287-7	A VFN	Blue		
048011-08858-7	A CRS	Brown	1/2" x 18"	
048011-08857-0	A MED	Maroon		
048011-08856-3	A VFN	Blue		
048011-05741-5	A CRS	Brown	1/2" x 24"	
048011-03998-5	A MED	Maroon		
048011-04299-2	A VFN	Blue		
048011-13639-4	A CRS	Brown	3/4" x 18"	
048011-15899-0	A MED	Maroon		
048011-14543-3	A VFN	Blue		

Scotch-Brite™ SC Surface Conditioning Belts (cont.)

UPC	Grade	Color	W x L	Qty./Case	
Portable, Benchtop and Backstand					
048011-14278-4	A CRS	Brown	1" x 18"	10	
048011-14398-9†	A MED	Maroon			
048011-17517-1†	A VFN	Blue			
048011-04189-6	A MED	Maroon	1" x 42"		
048011-04190-2	A VFN	Blue			
048011-08913-3†	A MED	Maroon	1" x 132"		5
048011-08915-7	A MED	Maroon	2" x 48"	10	
048011-04295-4	A VFN	Blue			
048011-08883-9†	A CRS	Brown	2" x 72"		
048011-00580-5	A MED	Maroon			
048011-00579-9	A VFN	Blue			
048011-03999-2	A MED	Maroon	2" x 132"		5
048011-04297-8	A VFN	Blue			
048011-05022-5	A CRS	Brown	2-3/4" x 15-1/2"	10	
048011-05227-4	A MED	Maroon			
048011-05820-7	A CRS	Brown			
048011-05783-5	A MED	Maroon	3" x 10-11/16"		
048011-09650-6	A VFN	Blue			
048011-14284-5†	A CRS	Brown	3" x 18"		
048011-14285-2	A MED	Maroon			
048011-14550-1	A VFN	Blue			
048011-08880-8	A CRS	Brown	3" x 24"		5
048011-00583-6	A MED	Maroon			
048011-04298-5	A VFN	Blue			
048011-05023-2	A CRS	Brown	3" x 132"		
048011-00568-3	A MED	Maroon			
048011-04289-3	A VFN	Blue			
048011-05016-4	A CRS	Brown	3-1/2" x 15-1/2"	10	
048011-05228-1	A MED	Maroon			
048011-05643-2	A VFN	Blue			
048011-08882-2†	A CRS	Brown	4" x 24"		
048011-00585-0†	A MED	Maroon			
048011-05018-8†	A CRS	Brown	4" x 132"		5
048011-00570-6	A MED	Maroon			
048011-04281-7	A VFN	Blue			
048011-05019-5	A CRS	Brown	6" x 48"		
048011-00590-4	A MED	Maroon			
048011-04283-1	A VFN	Blue			

† Made-to-Order

See pages 72–77 for available accessories.

Scotch-Brite™ Surface Conditioning Belts (cont.)

Scotch-Brite™ Durable Flex (DF) Surface Conditioning Belt

- Durable Flex belt has great edge durability
- Aggressive and long lasting non-woven belt for deburring, finishing, blending and cleaning
- The reinforced low-stretch backing offers good flexibility



517724

UPC	Grade	Color	W x L	Qty./Case
048011-64472-1	A CRS	Brown	1/4" x 18"	20
048011-64455-4	A MED	Maroon		
048011-64464-6	A FIN	Green		
048011-64473-8	A CRS	Brown	1/4" x 24"	
048011-64456-1	A MED	Maroon		
048011-64465-3	A FIN	Green		
048011-64474-5	A CRS	Brown	1/2" x 12"	
048011-64457-8	A MED	Maroon		
048011-64466-0	A FIN	Green		
048011-64475-2	A CRS	Brown	1/2" x 18"	
048011-64458-5	A MED	Maroon		
048011-64467-7	A FIN	Green		
048011-64476-9	A CRS	Brown	1/2" x 24"	
048011-64459-2	A MED	Maroon		
048011-64468-4	A FIN	Green		
048011-64477-6	A CRS	Brown	3/4" x 18"	
048011-64460-8	A MED	Maroon		
048011-64469-1	A FIN	Green		
048011-64489-9	A CRS	Brown	2-3/4" x 15-1/2"	10
048011-64482-0	A MED	Maroon		
048011-64486-8	A CRS	Brown	3" x 10-11/16"	
048011-64480-6	A MED	Maroon		
048011-64488-2	A CRS	Brown	3" x 18"	
048011-64483-7	A MED	Maroon		
048011-64484-4	A FIN	Green		
048011-64487-5	A CRS	Brown	3" x 24"	
048011-64481-3	A MED	Maroon		
048011-64485-1	A FIN	Green		
048011-64479-0	A CRS	Brown	3" x 132"	5
048011-64462-2	A MED	Maroon		
048011-64471-4	A FIN	Green		
048011-64478-3	A CRS	Brown	3-1/2" x 15-1/2"	10
048011-64461-5	A MED	Maroon		
048011-64470-7	A FIN	Green		

Scotch-Brite™ PD Surface Conditioning Belt

- Aluminum oxide abrasive mineral
- Open woven belt resistant to loading on soft and/or oily materials
- Reinforced backing offers good flexibility



681902

681917

UPC	Grade	Color	W x L	Qty./Case
048011-92126-6	A CRS	Brown	Belt sizes made to order. Specify UPC, grade and belt size (W" x L"). Belts wider than 25" require multiple splices.	Determined by belt size.
048011-92125-9				
048011-92127-3				
048011-92259-1	A MED	Maroon		

ATTENTION: Belts are available in other grades and sizes. If you need a specific belt not listed, contact your 3M Sales Specialist or 3M Authorized Distributor.

See pages 72–77 for available accessories.

Scotch-Brite™ Wheels

Get high performance and durability in a variety of cleaning, deburring, finishing and polishing applications. Used on right angle grinders and bench tools, Scotch-Brite™ Wheels produce great results on all types of metal, composites and glass.

Convolute Wheels Selection Guides

Scotch-Brite™ Convolute Wheel performance differences can be attributed to mineral (aggressiveness) and density (hardness). The combination of these two characteristics and subtle variations determine if the wheel will cut more aggressively or will be more durable and less conformable (See below).

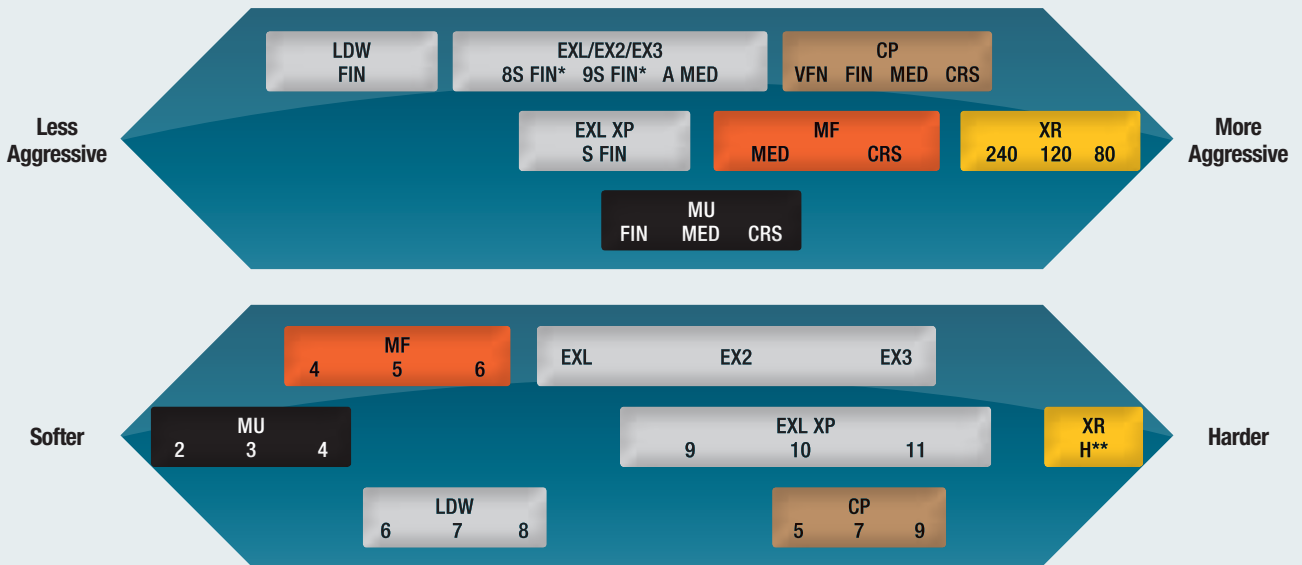

Legend

CP	Cut and Polish Wheel	LDW	Light Deburring Wheel	MU	Multi-Finishing Wheel
EXL	EXL Deburring Wheel	MF	Metal Finishing Wheel	XR	XR Metalworking Wheel

* Numeric designators (8/9) represent mineral aggressiveness; not density.

** XR Wheel Density: H = Hard

	Scotch-Brite™ Convolute Wheel	Application				
		Cleaning	Deburring	Blending	Finishing	Polishing
Best	EXL Deburring		●	●	●	●
	EXL-XP Deburring		●	●	●	●
	Metal Finishing	●		●	●	
	Cut and Polish			●		
	Multi-Finishing			●	●	
	XR Metalworking		●	●		
	Light Deburring		●		●	

Density Number (prefix to mineral)

soft ← → hard

2	4	6	7	8	9	10	11
---	---	---	---	---	---	----	----

Mineral Abbreviations (prefix to grade)

A—Aluminum Oxide mineral
S—Silicon Carbide mineral

ATTENTION: Wheels are available in other grades and sizes. If you need a specific wheel not listed, contact your 3M Sales Specialist or 3M Authorized Distributor.

See pages 72–77 for available accessories.

Scotch-Brite™ Convolute Wheels

Scotch-Brite™ EXL-XP Deburring Wheels

- The new long life addition to the EXL family
- Excellent for deburring, polishing and finishing all types of metals, composites and glass



528678

UPC	Grade	Max. RPM	Dia. x W x AH	Qty./Case
048011-60442-8	9S FIN	6,000	6" x 1/2" x 1"	4
048011-60447-3	10S FIN			
048011-60452-7	11S FIN			
048011-60306-3	9S FIN			
048011-60310-0	10S FIN	4,500	6" x 1" x 1"	3
048011-60315-5	11S FIN			
048011-60443-5	9S FIN			
048011-60448-0	10S FIN			
048011-60453-4	11S FIN	4,500	8" x 1/2" x 3"	4
048011-60307-0	9S FIN			
048011-60311-7	10S FIN			
048011-60316-2	11S FIN			
048011-60444-2	9S FIN	3,000	8" x 1" x 3"	3
048011-60449-7	10S FIN			
048011-60454-1	11S FIN			
048011-60445-9	9S FIN			
048011-60317-9	10S FIN	3,000	8" x 2" x 3"	2
048011-60450-3	11S FIN			
048011-60308-7	9S FIN			
048011-60312-4	10S FIN			
048011-60317-9	11S FIN	3,000	12" x 1/2" x 5"	4
048011-60451-0	10S FIN			
048011-60455-8	11S FIN			
048011-60455-8	11S FIN			
048011-60455-8	11S FIN	3,000	12" x 1" x 5"	1
048011-60455-8	11S FIN			
048011-60455-8	11S FIN			
048011-60455-8	11S FIN			
048011-60455-8	11S FIN	3,000	12" x 2" x 5"	1
048011-60455-8	11S FIN			
048011-60455-8	11S FIN			
048011-60455-8	11S FIN			

Scotch-Brite™ EXL, EX2 and EX3 Deburring Wheels

- Silicon carbide mineral
- Use to clean, finish, blend, deburr or polish all types of metals, composites and glass



14497

UPC	Grade	Max. RPM	Size	Qty./Case
EXL				
048011-13616-5	8A MED	6,000	6" x 1/2" x 1"	4
048011-09548-6	8S FIN			
048011-05790-3	9S FIN			
048011-13617-2	8A MED			
048011-18278-0	8S MED	6,000	6" x 1" x 1"	3
048011-09549-3	8S FIN			
048011-05132-1	9S FIN			
048011-13618-9	8A MED			
048011-05133-8	9S FIN	3,000	6" x 2" x 1"	2
048011-05133-8	9S FIN			
048011-05133-8	9S FIN			
048011-05133-8	9S FIN			

Scotch-Brite™ EXL, EX2 and EX3 Deburring Wheels (cont.)

UPC	Grade	Max. RPM	Size	Qty./Case
EXL (cont.)				
048011-14791-8	8S FIN	4,500	8" x 3/8" x 3"	4
048011-17459-4	8A MED			
048011-14629-4	8S FIN			
048011-05791-0	9S FIN			
048011-13619-6	8A MED	4,500	8" x 1" x 3"	3
048011-18279-7	8S MED			
048011-09551-6	8S FIN			
048011-05135-2	9S FIN			
048011-13620-2	8A MED	3,600	8" x 2" x 3"	2
048011-09552-3	8S FIN			
048011-05136-9	9S FIN			
048011-05137-6	9S FIN			
048011-15641-5	8S FIN	3,000	10" x 1" x 5"	2
048011-09005-4	9S FIN			
048011-13621-9	8A MED			
048011-18281-0	8S MED			
048011-09554-7	8S FIN	3,000	12" x 1/2" x 5"	1
048011-05138-3	9S FIN			
048011-13622-6	8A MED			
048011-09555-4	8S FIN			
048011-05139-0	9S FIN	2,550	12" x 1" x 5"	1
048011-13623-3	8A MED			
048011-05141-3	9S FIN			
048011-05141-3	9S FIN			
EX2				
048011-17215-6	8A MED	6,000	6" x 1/2" x 1"	4
048011-18285-8	8S MED			
048011-17216-3	8S FIN			
048011-24532-4	9S FIN			
048011-17217-0	8A MED	6,000	6" x 1" x 1"	3
048011-18286-5	8S MED			
048011-17218-7	8S FIN			
048011-18040-3	9S FIN			
048011-17426-6	8A MED	4,500	8" x 1/2" x 3"	4
048011-17425-9	8S FIN			
048011-17219-4	8A MED			
048011-17220-0	8S FIN			
048011-18365-7	9S FIN	3,000	8" x 1" x 3"	3
048011-17223-1	8A MED			
048011-17224-8	8S FIN			
048011-17224-8	8S FIN			
EX3				
048011-24026-8	9S FIN	6,000	6" x 1/2" x 1"	4
048011-18825-6			6" x 1" x 1"	
048011-24527-0		4,500	8" x 1" x 3"	3
048011-18826-3			3,000	

See pages 72–77 for available accessories.

Scotch-Brite™ Convolute Wheels (cont.)

Scotch-Brite™ Multi-Finishing Wheels

- Produces uniform grain finishes on stainless steel and other metals
- Highly conformable



51736

UPC	Grade	Max. RPM	Dia. x W x AH	Qty./Case
048011-13170-2	2S CRS	6,000	6" x 1" x 1"	3
048011-13171-9	2S MED			
048011-13172-6	2S FIN		6" x 2" x 1"	2
048011-13176-4	2S CRS			
048011-13177-1	2S MED	4,500	8" x 1" x 3"	3
048011-13178-8	2S FIN			
048011-13183-2	2S MED		8" x 2" x 3"	2
048011-13184-9	2S FIN			
048011-13185-6	2S CRS			
048011-13186-3	2S MED			

Scotch-Brite™ XR Metalworking Wheels

- Increased mineral loading and grinding aids
- Provides a fast cut and improved wheel efficiency for extended life



31169

UPC	Grade	Max. RPM	Dia. x W x AH	Qty./Case
048011-33695-4†	HA 80	3,600	6" x 1/2" x 1"	2
048011-33067-9	HA 120			
048011-33072-3†	HA 240		6" x 1" x 1"	1
048011-33696-1†	HA 80			
048011-33068-6	HA 120			
048011-33073-0	HA 240			
048011-64506-3†	HA 120	3,450	8" x 1/4" x 3"	2
048011-33697-8†	HA 80		8" x 1/2" x 3"	
048011-33069-3†	HA 120		8" x 1" x 3"	1
048011-64445-5†	HA 240			
048011-33698-5†	HA 80			
048011-33070-9†	HA 120			
048011-33075-4	HA 240	1,750	12" x 1" x 5"	1
048011-33699-2†	HA 80			
048011-33071-6†	HA 120			
048011-33076-1†	HA 240			

† Made-to-Order

Scotch-Brite™ Light Deburring Wheel

- Designed to provide a clean and economical system for removing fine burrs, yet resulting in a highly polished finish
- Ideal for fine deburring, polishing and finishing because of its conformability



94536

UPC	Grade	Max. RPM	Dia. x W x AH	Qty./Case
048011-03993-0	6S FIN	6,000	6" x 1/2" x 1"	4
048011-01662-7	7S FIN			
048011-03994-7	8S FIN			
048011-01660-3	6S FIN		6" x 1" x 1"	3
048011-01661-0	7S FIN			
048011-01675-7	8S FIN			
048011-01664-1	7S FIN	4,500	6" x 2" x 1"	2
048011-05263-2	7S FIN		8" x 1/2" x 3"	4
048011-01678-8	8S FIN			
048011-01665-8	6S FIN		8" x 1" x 3"	3
048011-01666-5	7S FIN			
048011-01679-5	8S FIN		8" x 2" x 3"	2
048011-01667-2	7S FIN			
048011-01683-2	7S FIN	3,600	10" x 1" x 5"	1
048011-05181-9	7S FIN	3,000	12" x 1/2" x 5"	
048011-01669-6	6S FIN		12" x 1" x 5"	
048011-01670-2	7S FIN			
048011-01686-3	8S FIN		12" x 2" x 5"	
048011-01672-6	6S FIN			
048011-01673-3	7S FIN		12" x 3" x 5"	
048011-01689-4	8S FIN			
048011-01690-0	7S FIN	2,250	16" x 2" x 10"	
048011-17985-8	7S FIN			

ATTENTION: Wheels are available in other grades and sizes. If you need a specific wheel not listed, contact your 3M Sales Specialist or 3M Authorized Distributor.

See pages 72–77 for available accessories.

Scotch-Brite™ Convolute Wheels (cont.)

Scotch-Brite™ Cut and Polish Wheels

- Heavy-duty wheels for aggressive blending and finishing
- Produce uniform results quickly and easily
- Replace rubber bonded wheels, set-up wheels and flap wheels



UPC	Grade	Max. RPM	Dia. x W x AH	Qty./Case
048011-05253-3†	7A CRS	6,000	6" x 1/2" x 1"	4
048011-08931-7†	7A MED			
048011-05182-6	5A FIN			
048011-08946-1†	7A FIN			
048011-03263-4†	7A CRS		6" x 1" x 1"	3
048011-03262-7†	7A MED			
048011-02960-3	5A FIN			
048011-03270-2	7A FIN			
048011-03269-6†	7A VFN			
048011-93503-4†	5A FIN			
048011-03273-3†	7A CRS	6" x 1" x 1-1/4"	2	
048011-03272-6†	7A MED	6" x 2" x 1"		
048011-02972-6†	5A FIN	6" x 25" x 1"	1	
048011-60043-7†	7A MED			
048011-05183-3†	7A MED	4,500	8" x 1/2" x 3"	4
048011-09018-4†	5A FIN			
048011-14623-2†	7A FIN		8" x 1" x 1-1/4"	3
048011-02974-0†	5A FIN			
048011-03277-1†	7A CRS		8" x 1" x 3"	2
048011-03276-4	7A MED			
048011-02965-8†	5A FIN			
048011-03275-7†	7A FIN			
048011-03274-0†	7A VFN		8" x 1-1/2" x 1-1/4"	1
048011-92862-3†	5A FIN			
048011-08934-8†	7A MED	8" x 1-1/2" x 3"	3	
048011-04156-8†	5A FIN			
048011-02976-4†	5A FIN	8" x 2" x 1-1/4"	2	
048011-03282-5†	7A CRS			
048011-03281-8	7A MED	8" x 2" x 3"	1	
048011-02967-2†	5A FIN			
048011-03280-1†	7A FIN			
048011-03279-5†	7A VFN			
048011-93674-1†	7A MED	8" x 2-1/2" x 3"	1	

† Made-to-Order

Scotch-Brite™ Cut and Polish Wheels (cont.)

UPC	Grade	Max. RPM	Dia. x W x AH	Qty./Case
048011-03283-2†	7A MED	4,500	8" x 3" x 3"	1
048011-02979-5†	5A FIN			
048011-93454-9†	7A CRS		8" x 4" x 3"	
048011-92936-1†	7A MED			
048011-93675-8†	7A MED		8" x 5" x 3"	
048011-05248-9†	7A FIN			
048011-13488-8†	5A FIN		8" x 7" x 3"	
048011-25617-7†	7A MED			
048011-15591-3†	5A FIN		8" x 20" x 3"	
048011-13486-4†	7A CRS			
048011-92938-5†	7A MED	8" x 24" x 3"		
048011-16463-2†	5A FIN			
048011-60040-6†	7A VFN	8" x 25" x 3"		
048011-04244-2†	7A MED			
048011-05256-4†	5A FIN	3,000	12" x 1/2" x 5"	2
048011-03295-5†	7A CRS			
048011-03294-8†	7A MED		12" x 1" x 5"	
048011-02975-7†	5A FIN			
048011-93677-2†	7A MED		12" x 1-1/2" x 5"	
048011-02977-1†	5A FIN			
048011-03300-6†	7A CRS		12" x 2" x 5"	
048011-03299-3	7A MED			
048011-02969-6	5A FIN		12" x 2" x 5"	
048011-03297-9†	7A VFN			
048011-03303-7†	7A MED	12" x 3" x 5"		
048011-05908-2†	5A FIN			
048011-03301-3†	7A VFN	12" x 3" x 5"		
048011-05533-6†	7A MED			
048011-02983-2†	5A FIN	12" x 4" x 5"		
048011-05243-4†	7A VFN			
048011-16913-2†	5A FIN	12" x 5" x 5"		
048011-27887-2†	5A FIN			
048011-60042-0†	7A CRS	12" x 24" x 5"		
048011-60044-4†	7A MED			
048011-60041-3†	7A VFN	12" x 25" x 5"		

† Made-to-Order

See pages 72–77 for available accessories.

Scotch-Brite™ Convolute Wheels (cont.)

Scotch-Brite™ Metal Finishing Wheels

- Provides a consistent and uniform decorative brushed finish
- Use to match #3 and #4 mill finishes
- Removes minor imperfections and handling marks



96879

UPC	Grade	Max. RPM	Size	Qty./Case
048011-05394-3†	6A CRS	6,000	6" x 1/2" x 1"	4
048011-05391-2†	5A MED			
048011-01861-4	4A CRS		6" x 1" x 1"	3
048011-01863-8	5A CRS			
048011-01866-9	6A CRS			
048011-01860-7†	4A MED			
048011-01862-1	5A MED			
048011-01865-2	6A MED			
048011-30012-2†	5A CRS		6" x 1" x 1-1/4"	3
048011-24110-4†	5A MED			
048011-01868-3	4A CRS		6" x 2" x 1"	2
048011-01888-1	5A CRS			
048011-01870-6†	6A CRS			
048011-01867-6	4A MED			
048011-01869-0	5A MED			
048011-01889-8†	6A MED			
048011-01891-1†	4A CRS			
048011-08891-4†	4A MED			
048011-09118-1†	5A CRS	6" x 3" x 1"	1	
048011-14336-1†	5A CRS			
048011-08891-4†	4A MED			
048011-09118-1†	5A CRS	6" x 4" x 1"	1	
048011-14336-1†	5A CRS			
048011-08891-4†	4A MED			
048011-09118-1†	5A CRS	6" x 6" x 1"	1	
048011-14336-1†	5A CRS			
048011-08891-4†	4A MED			
048011-16449-6†	5A MED	4,500	8" x 1/2" x 3"	4
048011-05414-8†	4A CRS			
048011-01872-0	5A CRS		8" x 1" x 3"	3
048011-01901-7	6A CRS			
048011-08926-3†	4A MED			
048011-01871-3	5A MED			
048011-01900-0†	6A MED			
048011-92896-8†	5A CRS			
048011-92896-8†	5A CRS		8" x 1-1/2" x 3"	3
048011-01875-1†	4A CRS			
048011-01904-8	5A CRS		8" x 2" x 3"	2
048011-13453-6†	6A CRS			
048011-01874-4	4A MED			
048011-01876-8	5A MED			
048011-01905-5†	6A MED			

† Made-to-Order

Scotch-Brite™ Metal Finishing Wheels (cont.)

UPC	Grade	Max. RPM	Size	Qty./Case
048011-15608-8†	5A CRS	4,500	8" x 3" x 3"	1
048011-13451-2†	6A CRS			
048011-13452-9†	4A MED			
048011-05395-0†	5A MED			
048011-25612-2†	6A MED			
048011-15607-1†	5A MED	3,000	12" x 1/2" x 5"	2
048011-05398-1†	5A CRS		12" x 1" x 5"	1
048011-15062-8†	6A CRS			
048011-01916-1	5A MED			
048011-08924-9†	6A MED			
048011-25619-1†	6A MED		12" x 1-1/4" x 5"	1
048011-25621-4†	6A CRS			
048011-15326-1†	5A MED		12" x 1-1/2" x 5"	1
048011-09612-4†	4A CRS			
048011-13449-9	5A CRS		12" x 2" x 5"	1
048011-13448-2†	6A CRS			
048011-01921-5†	4A MED			
048011-01882-9	5A MED			
048011-14617-1†	6A MED			
048011-13446-8†	4A CRS			
048011-08902-7†	5A CRS			
048011-92916-3†	4A MED			
048011-08929-4†	5A MED			
048011-16422-9†	5A MED	12" x 3" x 5"		
048011-13445-1†	4A CRS			
048011-13071-2†	5A CRS	12" x 3-1/2" x 5"	1	
048011-18634-4†	6A CRS			
048011-25615-3†	4A MED	12" x 4" x 5"	1	
048011-05392-9†	5A MED			

† Made-to-Order

ATTENTION: Wheels are available in other grades and sizes. If you need a specific wheel not listed, contact your 3M Sales Specialist or 3M Authorized Distributor.

See pages 72–77 for available accessories.

Unitized Wheels Selection Guides

Scotch-Brite™ Unitized Wheel performance differences can be attributed to mineral (aggressiveness) and density (hardness). The combination of these two characteristics and subtle variations determine if the wheel will cut more aggressively or will be more durable and less conformable (See below).

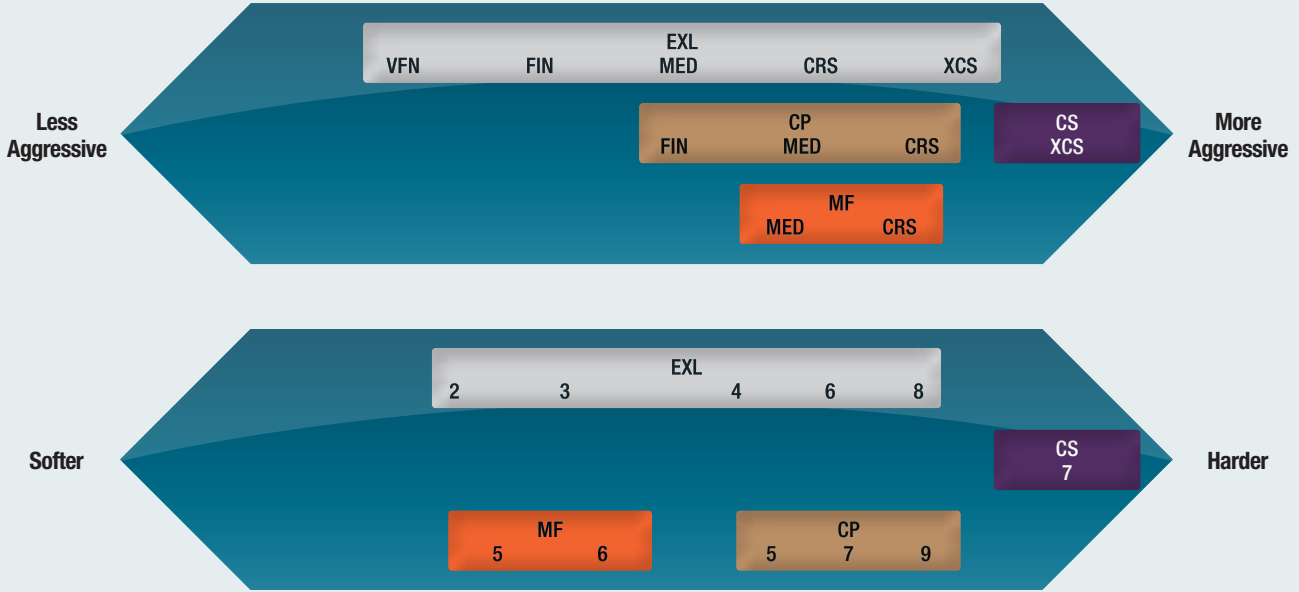

Legend	
	CP Cut and Polish Unitized Wheel
	EXL EXL Unitized Wheel
	CS Clean and Strip Unitized Wheel
	MF Metal Finishing Unitized Wheel

* No mineral: Use with abrasive compound.

Scotch-Brite™ Unitized Wheel	Application				
	Cleaning	Deburring	Blending	Finishing	Polishing
Best EXL Deburring		●	●		●
Cut and Polish		●	●		●
Metal Finishing			●	●	
Clean and Strip	●				

Density Number (prefix to mineral)

soft ←————→ hard

2	4	6	7	8	9	10	11
---	---	---	---	---	---	----	----

Mineral Abbreviations (prefix to grade)

A—Aluminum Oxide mineral
S—Silicon Carbide mineral

See pages 72–77 for available accessories.

Scotch-Brite™ Unitized Wheels

Scotch-Brite™ EXL Unitized Deburring Wheels

- Strong and efficient for deburring and polishing of all metal alloys
- Excellent in resisting smearing and minimizing heat buildup on the work piece
- Conformable wheel in a variety of densities and grades for maximum cut and durability



51730

UPC	Grade	Max. RPM	Dia. x W x AH	Qty./Case	
048011-15516-6	8A CRS	35,100	1" x 1/8" x 1/8"	100	
048011-15517-3	6A MED		1" x 1/4" x 1/8"		
048011-13734-6	2S FIN		1" x 1" x 3/16"		50
048011-13752-0	8A CRS	1" x 1" x 3/16"			
048011-15527-2	2A MED	1" x 1" x 3/16"			
048011-14063-6	6A MED	1" x 1" x 3/16"			
048011-13753-7	8A MED	1" x 1" x 3/16"			
048011-13713-1	2S FIN	1" x 1" x 3/16"	50		
048011-15514-2	8A CRS	30,100	1-1/2" x 1/8" x 3/16"	80	
048011-15515-9	6A MED		1-1/2" x 1/4" x 1/8"		
048011-13714-8	2S FIN		1-1/2" x 1/4" x 1/8"		
048011-14746-8	2S FIN	1-1/2" x 1/4" x 3/16"	80		
048011-15511-1	8A CRS	22,100	2" x 1/8" x 3/16"	60	
048011-15512-8	6A MED		2" x 1/8" x 3/16"		
048011-13736-0	2S FIN	16,100	2" x 1/4" x 1/8"		
048011-15513-5	2S FIN		2" x 1/4" x 3/16"		
048011-13755-1	8A CRS	22,100	2" x 1/4" x 1/4"		30
048011-15529-6	2A MED	16,100	2" x 1/4" x 1/4"		
048011-13932-6	2S FIN		2" x 1/2" x 1/4"		
048011-13715-5	2S FIN	18,100	3" x 1/8" x 1/4"	40	
048011-15462-6	8A MED	18,100	3" x 1/4" x 1/4"		
048011-13763-6	8A CRS		3" x 1/4" x 1/4"		
048011-15531-9	2A MED	12,100	3" x 1/4" x 1/4"		
048011-14067-4	6A MED	18,100	3" x 1/4" x 1/4"		
048011-13764-3	8A MED		3" x 1/4" x 1/4"		
048011-13716-2	2S FIN	12,100	3" x 1/4" x 1/4"	40	

Scotch-Brite™ EXL Unitized Deburring Wheels (cont.)

UPC	Grade	Max. RPM	Dia. x W x AH	Qty./Case
048011-13766-7	8A CRS	18,100	3" x 1/4" x 3/8"	40
048011-16054-2	2A MED	12,100		
048011-15118-2	6A MED	18,100		
048011-14753-6	8A MED			
048011-14750-5	2S FIN	12,100		
048011-14751-2	4A FIN	18,100		
048011-14752-9	6S FIN			
048011-13767-4	8A CRS	15,100	3" x 1/2" x 1/4"	20
048011-15532-6	2A MED	10,000		
048011-13717-9	2S FIN	8,500	3" x 3/4" x 1/4"	10
048011-13718-6	2S FIN		4" x 1/4" x 1/4"	20
048011-13739-1	2S FIN	5,000	6" x 1/4" x 1/2"	8
048011-17498-3	2A MED			
048011-13741-4	2S FIN	5,000	6" x 1/4" x 3/4"	4
048011-25678-8	2S FIN		4,500	
048011-15534-0	2A MED	5,000	6" x 1/2" x 1/2"	
048011-13719-3	2S FIN		6" x 1/2" x 5/8"	
048011-15831-0	2S FIN	5,000	6" x 1/2" x 1"	
048011-16545-5	2A MED		6" x 1/2" x 1"	
048011-14379-8	2S FIN	5,000	6" x 1" x 1/2"	2
048011-13742-1	2S FIN		6" x 1" x 1"	
048011-16544-8	2A MED	4,500	8" x 1/4" x 1/2"	8
048011-13743-8	2S FIN	5,000		
048011-15827-3	2S FIN	4,000	8" x 1/2" x 1/2"	4
048011-15844-0	2S FIN		8" x 1/2" x 3/4"	
048011-15824-2	2S FIN		12" x 1/2" x 1-1/4"	
048011-15817-4	2S FIN	2,600	12" x 1/2" x 1-1/4"	2

ATTENTION: Wheels are available in other grades and sizes. If you need a specific wheel not listed, contact your 3M Sales Specialist or 3M Authorized Distributor.

See pages 72–77 for available accessories.

Scotch-Brite™ Unitized Wheels (cont.)

Scotch-Brite™ Metal Finishing Wheel



- Highly conformable wheel applies uniform and consistent satin/antique finishes
- Ideal for stainless steel to match #3 or #4 mill finishes and create brushed or satin finishes on cutlery
- Great on softer metals such as aluminum, copper and brass to blend out minor surface imperfections and handling marks

UPC	Grade	Max. RPM	Dia. x W x AH	Qty./Case
048011-29257-1	5A MED	6,000	6" x 1/2" x 1"	4
048011-29259-5			6" x 1" x 1"	2

Scotch-Brite™ Roloc™ EXL Unitized Wheels

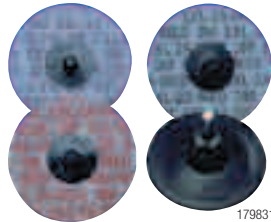

- Strong, efficient products for edge deburring and finishing
- Used with 3M™ Roloc™ or 3M™ Roloc™+ holder pads on a straight shaft or right-angle tool

UPC	Grade	Max. RPM	Size	Qty./Case
Roloc TR (Plastic Button)				
048011-17185-2	2A MED	22,100	2"	60
048011-17183-8	2S FIN			
048011-17190-6	6A MED			
048011-17192-0	8A MED	15,100	3"	40
048011-17186-9	2A MED			
048011-17184-5	2S FIN			
048011-17191-3	6A MED			
048011-17193-7	8A MED			

Scotch-Brite™ Clean and Strip Unitized Wheel



- Great for heavy duty cleaning applications
- Open web construction wheel runs smooth and resists loading of soft coatings
- Extra coarseness of web is perfect for removing scale, rust, surface contaminants and paints

UPC	Grade	Max. RPM	Dia. x W x AH	Qty./Case
048011-01003-8	7S XCS	35,100	1" x 1" x 3/16"	50
048011-01005-2		20,100	2" x 1/2" x 1/4"	30
048011-01009-0		14,100	3" x 1/2" x 1/4"	20
048011-01012-0				10
048011-01021-2		10,000	4" x 1" x 1/4"	5
048011-01032-8		7,000	6" x 1" x 5/8"	2
048011-01034-2				

Scotch-Brite™ Cut and Polish Unitized Wheel



- Tightly layered “unitized” construction offers long life and durability
- Excellent for aggressive heavy duty blending and finishing with uniform results
- Good replacement for rubber bonded wheels and small set-up wheels

UPC	Grade	Max. RPM	Dia. x W x AH	Qty./Case	
048011-03701-1	7A CRS	35,100	1" x 1" x 3/16"	50	
048011-03700-4	7A MED				
048011-01560-6	5A FIN				
048011-08939-3	7A MED	22,100	2" x 1/8" x 1/8"	60	
048011-03714-1	7A MED		2" x 1/8" x 1/4"		
048011-03716-5	7A CRS		2" x 1/4" x 1/4"		
048011-03715-8	7A MED				
048011-01561-3	5A FIN	20,100	2" x 1/2" x 1/4"	30	
048011-03718-9	7A MED				
048011-03727-1	7A MED	18,100	3" x 1/8" x 1/4"	40	
048011-03729-5	7A CRS				
048011-03728-8	7A MED		3" x 1/4" x 1/4"		
048011-01563-7	5A FIN				
048011-15121-2	5A FIN	15,100	3" x 1/4" x 3/8"	20	
048011-03705-9	7A MED				
048011-01565-1	5A FIN		3" x 1/2" x 1/4"		
048011-03732-5	7A MED				
048011-08878-5	5A FIN				
048011-03738-7	7A MED		3" x 1/2" x 3/8"		10
048011-03740-0	7A MED				
048011-01578-1	5A FIN	12,100	4" x 1/4" x 1/4"	20	
048011-01581-1	5A FIN	7,500	6" x 1/4" x 1/2"	8	

See pages 72–77 for available accessories.

Scotch-Brite™ Specialty Abrasives

Make tough jobs easy with these Scotch-Brite™ specialty abrasives. Unique constructions for use on contours and flat areas — on metal, wood, paint, coatings and more.

Scotch-Brite™ Radial Bristle Brush, TA

- Excellent replacement for wire brushes
- Use on bench motors for general purpose cleaning applications
- No flying wires yet higher cut rates
- Very strong and flexible
- Comes with adapters for multiple shaft sizes (1/2", 5/8", 3/4", 7/8", 1", 2" and 8")



159129

UPC	Grade	Color	Max. RPM	Dia. x W	Qty./Case
048011-24279-8	50	Green	25,000	3" x 3/8"	40
048011-24280-4	80	Yellow			
048011-24281-1	120	White			
048011-27603-8	36	Brown	6,000	6" x 1/2" x 1"	5
048011-27605-2	50	Green			
048011-27606-9	80	Yellow			

Scotch-Brite™ Flap Brush CPFB-S and CPFB-R+

- Heavy-duty brush
- Excellent for removing handling marks and surface imperfections
- Available on 1/4" shaft (CPFBS) or 3M™ Roloc™+ attachment system (CPFBR+)



51748

UPC	Grade	Max. RPM	Dia. x W x (Shaft)	Qty./Case
CPFBS				
048011-16622-3	A MED	12,000	2" x 1" x 1/4"	25
048011-05974-7		8,500	3" x 1-3/4" x 1/4"	10
CPFBR+				
048011-14588-4	A MED	8,000	3" x 1-3/8"	10



524406

Scotch-Brite™ Flap Brush CFFB-S and CFFB-R

- Ideal for decorative finishes and light deburring applications
- Available on 1/4" shaft (CFFB-S) or 3M™ Roloc™+ attachment system (CFFB-R)

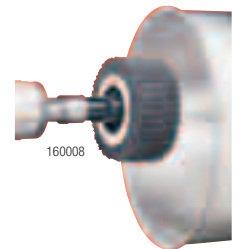

160008

UPC	Grade	Max. RPM	Dia. x W x (Shaft)	Qty./Case
CFFB-S				
048011-05975-4	A CRS	8,500	3" x 1-3/4" x 1/4"	10
048011-14781-9	S FIN			
CFFB-R				
048011-14587-7	A CRS	8,000	3" x 1-3/8"	10
048011-14783-3	S FIN			

Scotch-Brite™ Combi Wheel, Combi-S

- Made of alternating flaps of coated abrasive and Scotch-Brite™ web
- Provides aggressive cut and fine finishes



51752

UPC	Grade	Max. RPM	Dia. x W x Shaft	Qty./Case
CFFB-S				
051144-80801-4	80	8,000	3" x 1-3/4" x 1/4"	10
051144-80678-2	P120			
051144-80799-4	P180			

See pages 72–77 for available accessories.

Scotch-Brite™ Specialty Abrasives (cont.)

Scotch-Brite™ CPD5-R and CPD5-S Discs

- Five discs made of a durable web, ganged together on a shaft
- Use for satin or antique finishing as well as light- to medium-duty cleaning applications
- Available on a 1/4" shaft (CPD5-S) or 3M™ Roloc™+ attachment system (CPD5-R)



159131

UPC	Grade	Max. RPM	Dia. x W x (Shaft)	Qty./Case
CPD5-S				
048011-14593-8	A MED	10,000	3" x 1-1/4" x 1/4"	10
048011-14779-6		8,000	4" x 1-1/4" x 1/4"	
CPD5-R				
048011-14594-5	A MED	10,000	3" x 1-1/4"	10
048011-14590-7		8,000	4" x 1-1/4"	

Scotch-Brite™ Clean and Strip Discs D2

- Aggressive web is excellent for cleaning welds, rust, paint and coatings



51747

UPC	Grade	Max. RPM	Dia. x W x Shaft	Qty./Case
048011-14780-2	S XCS	8,000	4" x 1" x 1/4"	10
048011-14784-0			4" x 1"	8

Scotch-Brite™ Stars

- Perfect for polishing internal diameters of pipe and tubing
- Conformable Scotch-Brite™ construction assures complete cleaning and polishing of all surfaces



524413

UPC	Grade	Max. RPM	Diameter	Qty./Case
048011-13370-6	A CRS	24,000	1-1/2"	100
048011-13800-8	A VFN			
048011-13371-3	A CRS		2"	
048011-13803-9	A VFN			
048011-13372-0	A CRS	18,000	3"	50
048011-13802-2	A VFN			
048011-13373-7	A CRS		4"	
048011-13804-6	A VFN			

Scotch-Brite™ Cross Buffs



- Versatile and flexible shape ideal for light deburring, cleaning, finishing and polishing internal diameters and hard to reach areas
- Available in A VFN for high luster finishes or A MED for more aggressive applications requiring increased durability



UPC	Grade	Max. RPM	Diameter	Qty./Case
048011-64299-4	A MED	20,000	1" x 3/8" x 2 PLY x 8-32	50
048011-64446-2	A VFN			
048011-64305-2	A MED		1-1/2" x 3/8" x 2 PLY x 8-32	
048011-64526-1	A VFN			
048011-64447-9	A VFN	12,000	1-1/2" x 1/2" x 2 PLY x 8-32	100
048011-64312-0	A MED		2" x 1/2" x 2 PLY x 8-32	25
048011-64433-2	A VFN			

See pages 72–77 for available accessories.

524398



524413

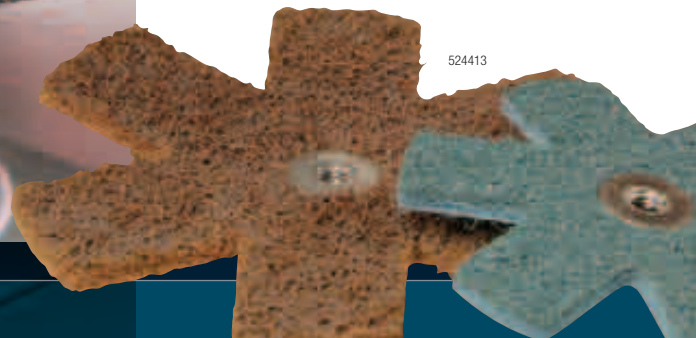

Scotch-Brite™ Hand Pads

Scotch-Brite™ Hand Pads

- Excellent products for hand finishing and cleaning of woods, metals and composites
- Ideal for wood finishing, paint prep and general cleaning

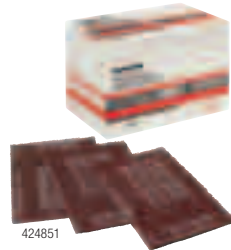

UPC	Grade	Color	Cat. No.	W x L	Qty./Case
048011-04050-9	A MED	Tan	7440	6" x 9"	40
048011-04051-6	S MED	Gray	7446		
048011-04029-5	A VFN	Maroon	7447		60
048011-04229-9			7447 Bulk		
048011-24037-4			8447		
048011-04028-8	S ULF	Light Gray	7448		

Scotch-Brite™ Hand Pad Selection Guide

	Blending	Finishing	Deburring	Cleaning
Good	Multi-Flex	Multi-Flex	—	Multi-Flex
Better	7446, 7447	7440, 7447, 7448	—	7447
Best	7440, 8447	7446, 8447	7440	8447

Less Aggressive/Finer Finish

More Aggressive/Coarser Finish



Scotch-Brite™ Ultra Fine Hand Pad 7448 (Gray)

- Ultra fine consistent finishes on metals, woods, plastics and composites
- Provides similar performance as steel wool grade 00



Scotch-Brite™ General Purpose Hand Pad 7447 (Maroon)

- Standard for surface conditioning worldwide
- Clean, blend, finish, and deburr faster, easier and with better results than conventional abrasives
- Provides similar performance as steel wool grade 1



Scotch-Brite™ Production Hand Pad 8447 (Maroon)

- High cut for paint preparation, blending, and scuffing
- Long life performance on aluminum, stainless steel, plastics, wood and fiberglass
- Provides similar performance as steel wool grade 2



Scotch-Brite™ Blending Hand Pad 7446 (Gray)

- Specially designed for hand blending and finishing stainless steel
- Mineral coarseness blends surface scratches on many metals, wood and synthetic surfaces
- Provides similar performance as steel wool grade 3



Scotch-Brite™ Heavy Duty Hand Pad 7440 (Tan)

- Most durable and aggressive pad for quick stock removal
- Cuts fast to remove contaminants and oxides in the most demanding cleaning and finishing applications
- Provides similar performance as steel wool grade 4

See pages 72–77 for available accessories.

Scotch-Brite™ Roll and Sheet Roll Selection Guide

	Blending	Finishing	Deburring	Cleaning
Good	Multi-Flex	Multi-Flex	—	Multi-Flex
Better	Clean and Finish	Clean and Finish	—	Clean and Finish
Best	Cut and Polish	Production Clean and Finish	Cut and Polish	Production Clean and Finish

Scotch-Brite™ Multi-Flex Sheet Rolls

- Highly conformable non-woven web roll is perforated to easily tear into sixty 8" x 4" sheets
- Excellent sharpness and conformability for cleaning and finishing surfaces by hand



51768

UPC	Grade	Color	W x L	Qty./Case
051131-07521-4	A VFN	Maroon	8" x 20'	2
051131-07522-1	S ULF	Light Gray		

Scotch-Brite™ Cut and Polish Rolls

- A unique and aggressive material for cleaning and finishing
- Sturdy, long lasting web material is great for heavy industrial cleaning and light deburring applications
- Works well for stropping and other bench applications



14432

UPC	Grade	W x L	Qty./Case
048011-04085-1	A MED	1" x 30'	2
048011-05206-9		2" x 30'	
048011-05207-6		4" x 30'	

Scotch-Brite™ Production Clean and Finish Rolls

- Precision web/mineral configuration for most uniform general purpose finishing in roll form
- Excellent for critical finishes and long life



601735

UPC	Grade	Color	W x L	Qty./Case
048011-28175-9†	A VFN	Maroon	4" x 30'	3
048011-28176-6†			6" x 30'	2

† Made-to-Order

Scotch-Brite™ Clean and Finish Rolls

- Highly conformable Scotch-Brite™ web can be cut to desired length for hand sanding or oscillating sanders



51764

UPC	Grade	W x L	Min./Case
048011-00291-0†	A FIN	2" x 30'	6
048011-00260-6	A VFN	3" x 30'	4
048011-00261-3			
048011-00264-4	A MED	4" x 30'	3
048011-00265-1	A FIN		
048011-00266-8	A VFN		
048011-00270-5			
048011-00263-7	F SFN		
048011-00267-5	S ULF		
048011-00268-2			
048011-00262-0	TALC		
048011-00274-3	A MED	6" x 30'	2
048011-00275-0	A FIN		
048011-00276-7	A VFN		
048011-00284-2			
048011-00254-5	TALC	12" x 30'	1

† Made-to-Order

14399



See pages 72–77 for available accessories.

3M™ Bonded Wheels

Durable and fast cutting wheels for your toughest grinding and cutting applications. Run with 3M™ Grinders or 3M™ Cut-Off Wheel Tools for optimal performance. For use on all metals. **DO NOT USE ON TOOLS WITHOUT GUARDS.**



	Product	Mineral	Type	
All Metals	Better	General Purpose	Aluminum Oxide	
			T27	
	Best	3M™ Green Corps™	3M™ Ceramic abrasive grain	T27
				T27 Flexible
				T27 Cut and Grind
			T28	

3M™ Bonded Type 27 Wheels

3M™ General Purpose Type 27 Wheel

- Aluminum oxide mineral
- Durable wheel provides exceptionally long life at a value price
- Excellent, economical choice for general purpose grinding on steel

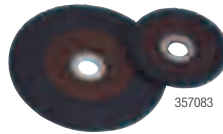

UPC	Grade	Max. RPM	Dia. x Thk. x AH	Qty./Case
051135-92312-2	24	13,300	4-1/2" x 1/4" x 7/8"	40
051135-92314-6			4-1/2" x 1/4" x 5/8-11 INT	
051135-92313-9	8,500	8,500	7" x 1/4" x 7/8"	20
051135-92315-3			7" x 1/4" x 5/8-11 INT	

3M™ Green Corps™ Type 27 Flexible Grinding Wheel

- 3M™ Ceramic abrasive grain
- Can be used on a wide variety of metals
- Smooth running wheels produce less noise and vibration when grinding
- Must be used on a tool with a guard



UPC	Grade	Max. RPM	Dia. x Thk. x AH	Qty./Case
051111-50440-6	36	13,300	4-1/2" x 1/8" x 7/8"	20/40
051111-50442-0	46			
051111-50443-7	60			
051111-50444-4	80			
051111-50445-1	36	8,500	7" x 1/8" x 7/8"	20/20
051111-50446-8	46			
051111-50447-5	60			

3M™ Green Corps™ Type 27 Depressed Center Wheel

- 3M™ Ceramic abrasive grain
- Provides exceptionally fast cut and long life
- Use with right angle grinders with a guard

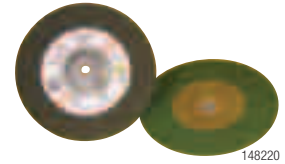

UPC	Grade	Max. RPM	Dia. x Thk. x AH	Qty./Case
051111-61010-7	24	15,000	4" x 1/4" x 3/8"	60
051111-55991-8	24	13,300	4-1/2" x 1/4" x 7/8"	40
051111-55992-5	36			
051111-55960-4	24		4-1/2" x 1/4" x 5/8-11 INT	
051111-55961-1	36	8,500	7" x 1/4" x 7/8"	20
051111-55989-5	24			
051111-55990-1	36		7" x 1/4" x 5/8-11 INT	
051111-55958-1	24			
051111-55959-8	36	6,600	9" x 1/4" x 7/8"	
051111-55987-1	24		9" x 1/4" x 5/8-11 INT	
051111-55956-7	24			

3M™ Green Corps™ Type 27 Cutting and Grinding Wheel

- 3M™ Ceramic abrasive grain
- Safe to grind outer face and cut with edge of same wheel



UPC	Grade	Max. RPM	Dia. x Thk. x AH	Qty./Case
051135-92316-0	36	13,300	4-1/2" x 1/8" x 7/8"	40
051135-92318-4			4-1/2" x 1/8" x 5/8-11 INT	
051135-92317-7	8,500	8,500	7" x 1/8" x 7/8"	20
051135-92319-1			7" x 1/8" x 5/8-11 INT	

3M™ Bonded Type 28 Wheels

NEW! 3M™ Green Corps™ T-28 Depressed Center Wheel

- Made with 3M™ Ceramic abrasive grain for fast cut rates and long life
- T28 shape works well when grinding at lower tool angles (15-25 degrees)
- Great for weld removal, grinding in tight areas and other MRO applications

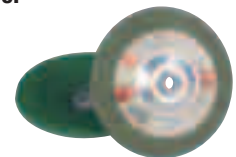

UPC	Grade	Max. RPM	Dia. x Thk. x AH	Qty./Case
051141-28327-2	24	8,500	7" x 1/4" x 5/8 INT	10

For safe applications using cut-off wheels, refer to ANSI B-7.1 for details. ALWAYS use appropriate wheel guards. Refer to ANSI B-186.1 for guarding requirements.

See pages 72-77 for available accessories.

3M™ Cut-Off Wheels

	Product	Mineral	Type
All Metals	Better General Purpose	Aluminum Oxide	T1
	Best 3M™ Green Corps™ High Performance	3M™ Ceramic abrasive grain	T1
			T1

3M™ General Purpose Cut-Off Wheels

- Value priced wheel provides fast cut and long life
- Best on carbon steel
- Must be used with ANSI-approved flanges for Type 1 cut-off wheels
- **Do not use on tools without guards**

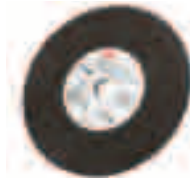

UPC	Max. RPM	Dia. x W x AH	Min./Case
051141-20447-5	10,200	6" x .045" x 7/8"	50/100
051141-20448-2	21,000	4" x 1/32" x 3/8"	
051141-20449-9		4" x 1/16" x 3/8"	

3M™ High Performance Cut-Off Wheel

- 3M™ Ceramic abrasive grain
- Provides faster cut and longer life on various substrates including stainless steel
- Must be used with ANSI-approved flanges for Type 1 cut-off wheels
- **Do not use on tools without guards**

UPC	Max. RPM	Dia. x W x AH	Min./Case
051141-20349-2	10,200	6" x .045" x 7/8"	50/200

3M™ Green Corps™ Cut-Off Wheels

- 3M™ Ceramic abrasive grain
- Provides high cut rates and long life on various substrates, including fiberglass, stainless steel and carbon steel
- Must be used with ANSI-approved flanges for Type 1 cut-off wheels
- **Do not use on tools without guards**

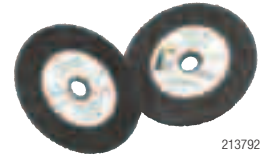

213792

UPC	Max. RPM	Dia. x W x AH	Qty./Case
051144-83487-7	42,000	2" x 1/16" x 1/4"	50/50
051144-82238-6	35,000	3" x 1/32" x 1/4"	
051131-01989-8	35,000	3" x 1/32" x 3/8"	5 wheels/pack 10 packs/case
051131-01985-0			50/50
051131-01990-4	28,000	3" x 1/16" x 3/8"	5 wheels/pack 10 packs/case
051131-01986-7			50/50
051144-83488-4	21,000	4" x 1/16" x 3/8"	50/50
051144-88755-2	26,250	4" x 1/32" x 1/4"	
051131-01994-2	26,250	4" x 1/32" x 3/8"	50/50
051141-20275-4	13,300	4-1/2" x 3/64" x 7/8"	50/200
051141-20276-1	12,200	4-59/64" x 3/64" x 7/8"	

See pages 72–77 for available accessories.

For safe applications using cut-off wheels, refer to ANSI B-7.1 for details. ALWAYS use appropriate wheel guards. Refer to ANSI B-186.1 for guarding requirements.



Kits and Packs

Scotch-Brite™ Surface Conditioning Disc Pack 9145S, 915S, 917S

- Contains a variety of grades of non-woven surface conditioning discs
- Used for cleaning, finishing, blending and deburring applications
- Includes 9145 disc pad holder

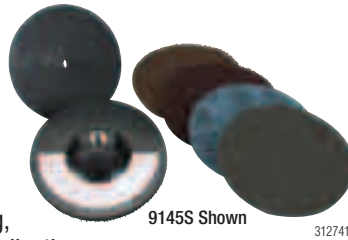

UPC (048011-)	Max RPM	Catalog No.	Size	Min./Case
14105-3	13,000	9145S	4-1/2"	1/5
08713-9	10,000	915S	5"	
04270-1	6,000	917S	7"	

Scotch-Brite™ Surface Conditioning Disc Pack 920S

- Contains a variety of grades of 2" and 3" non-woven surface conditioning discs
- Used for cleaning, finishing, blending and deburring applications
- Includes 922 and 923 disc pad holder

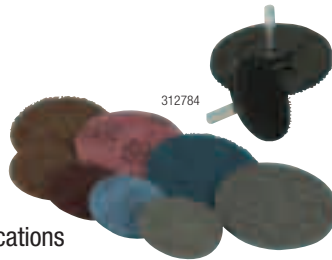

UPC (048011-)	Size	Min./Case
18253-7	2" and 3"	1/5

Scotch-Brite™ Hand Pad Trial Pack 961S

- Contains 1 each of the following:
 - Scrubbing Sponge 74
 - Light Duty Pad 6448
 - Heavy Duty Pad 7440
 - Light Duty Cleansing Pad 7445
 - Blending Pad 7446
 - General Purpose Pad 7447
 - Ultra Fine Pad 7448
 - Production Pad 8447
 - Twist-Lok™ Pad Holder 961



UPC (048011-)	Size	Min./Case
17144-9	6" x 9"	5

3M™ Roloc™ Disc Pack 982S and 983S

- Includes Roloc™ Surface Conditioning Discs, 3M™ Coated Abrasive Discs and 3M™ Roloc™ Disc Pad

UPC (051144-)	Catalog No.	Size	Min./Case
82899-9	982S	2"	1/5
82900-2	983S	3"	

3M™ Roloc™ Bristle Disc Pack 983BS

- Contains a variety of grades of 3M™ Roloc™ Bristle Discs 3" diameter x 5/8" trim
- Includes a disc pad holder



UPC (048011-)	Size	Min./Case
18697-9	3"	1/5

3M™ Roloc™ Disc Pack 985S

- Contains a variety of grades of 2" and 3" non-woven 3M™ Roloc™ Surface Conditioning Discs
- Also contains 2" and 3" disc pads and 1/4" threaded shaft

UPC (048011-)	Size	Min./Case
18254-4	2" and 3"	1/5

Scotch-Brite™ Unitized Wheel Pack 990S

- Contains several Scotch-Brite™ external Unitized Wheels 1" x 1" x 3/16" and 3" x 1/4" x 3/8" in a variety of densities and grades
- Also includes 936 and 990 mandrels

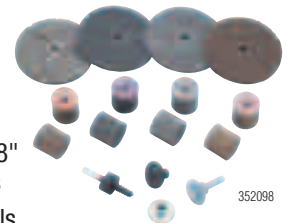

UPC (048011-)	Size	Min./Case
18245-2	1" x 1" x 3/16" and 3" x 1/4" x 3/8"	1/5

3M™ NTN Maintenance and Repair Kit







- Variety of easy mounting (no mounting tools required) coated and surface conditioning 4-1/2" discs for use on right angle tools
- Contains 1 each of the following:
 - 3M™ TN Disc Pad
 - Scotch-Brite™ Light Grinding and Blending Disc, TN, Super Duty
 - Scotch-Brite™ Clean and Strip XT Disc, TN, S XCS
 - 3M™ Fibre Disc 785C, TN, grade 36
 - 3M™ Flap Disc 747D, TN, grade 36



UPC (048011-)	Size	Min./Case
33013-6	4-1/2"	1/5



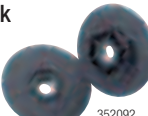
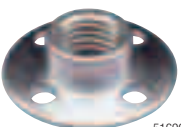

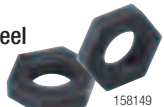
For appropriate product maximum operating speed, see kit package safety insert.

Accessories

Product Name	UPC	Qty./Case	For Use With	Size/Description	Max RPM
3M™ Fibre Disc Accessories					
3M™ Disc Pad Hub† 	051141-28442-2 NEW!	10	Short shaft tools†	2-1/2" Diameter; 3/8–24 metal insert	N/A
	051144-45205-7		3M™ Disc Pad Face Plates (all sizes)†	2-1/2" Diameter; 5/8–11 metal insert	
	051144-88743-9		3M™ Disc Pad Face Plates (all sizes, tool shaft length 1/2" or less)†		
	051144-45190-6		3M™ Disc Pad Face Plates (7" or larger)†	4-1/2" Diameter; 5/8–11 metal insert	
3M™ Low Profile Disc Pad Hub† 	051141-28476-7 NEW!	1	3M™ Disc Pad Face Plates (all sizes, tool shaft length 1/2" or less)†	2-1/2" Diameter; 5/8–11 metal insert	N/A
3M™ Disc Pad Face Plates 	051144-13325-3	10	Fibre Discs	4-1/2" Diameter; Smooth; Medium – Gray	13,300
	051144-14270-5			4-1/2" Diameter; Smooth; Hard – Black	
	051141-28443-9 NEW!			4-1/2" Diameter; Ribbed; Extra Hard – Red	
	051144-81734-4			5" Diameter; Ribbed; Medium – Gray	12,000
	051144-81733-7			5" Diameter; Ribbed; Hard – Black	
	051144-81732-0			5" Diameter; Ribbed; Extra Hard – Red	
	051144-80516-7			7" Diameter; Ribbed; Medium – Gray	8,600
	051144-80515-0			7" Diameter; Ribbed; Hard – Black	
	051144-80514-3			7" Diameter; Ribbed; Extra Hard – Red	
3M™ Fibre Disc Backup Pad and Retainer Nut 	051141-28530-6 NEW!	1	4" Fibre Discs with 5/8" Center Hole	4" Diameter; 3/8–24 INT	15,000
3M™ TN Quick Change Disc Backup Pad 	051111-56573-5	5	4-1/2" TN Discs	4-1/2" x 5/8–11 INT	13,300
3M™ Disc Retainer Nuts 	051111 -51047-6	10	3M™ Disc Pad Face Plates and Disc Pad Hubs	5/16" Depth; 5/8–11 Thread	N/A
	051144 -05622-4			3/8" Depth; 5/8–11 Thread	
	051144 -05621-7			1/2" Depth; 5/8–11 Thread	
	051144 -05620-0			5/8" Depth; 5/8–11 Thread	
3M™ Disc Holder Adapter No. 9 	048011-22971-3	10	Converts grinders with M10–1.25, M10–1.5, or 3/8–24 external threaded shaft to a 5/8–11 external threaded shaft	M10–1.25 INT	N/A
	048011-22972-0			M10–1.50 INT	
	048011-22970-6			3/8–24 INT	
3M™ Flap Discs/Bonded Wheels Accessories					
Flap Disc/ Grinding Wheel Adapter Nut 	051144-88765-1	1 Pair/5 Pairs	Secures 4-1/2" diameter flap discs or 4-1/2" grinding wheels to right angle tool with a 5/8–11 threaded shaft	5/8–11 Thread Size	N/A

† Also for use with Scotch-Brite Light Grinding and Blending Discs.

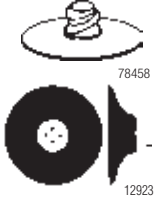
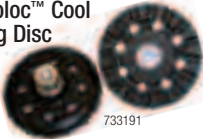
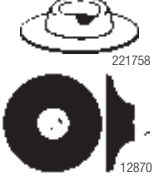
Accessories

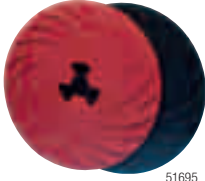

Product Name	UPC	Qty./Case	For Use With	Size/Description	Max RPM
3M™ Flap Discs/Bonded Wheels Accessories (cont.)					
Flap Disc Holder 	051144-88769-9	1	Backup plate for 7" diameter flap discs or 8" diameter type 27 grinding wheels	4" Diameter; 5/8–11 Thread Size	N/A
3M™ Green Corps™ Flexible Grinding Disc 	051111-51046	5/100	Backup plate for 4-1/2" center hole flexible grinding wheel	7/8" Center Hole Diameter; 3-3/8" Diameter; Clear	N/A
	051111-51045		Backup plate for 7" center hole flexible grinding wheel	7/8" Center Hole Diameter; 4-5/8" Diameter; Clear	
3M™ Roloc™ Disc Accessories					
3M™ Roloc™ TR Disc Pads 	051144-45101-2	5	3M™ Roloc™ TR Discs	1" Diameter; Medium; 1/4–20 INT	30,000
	051144-45099-2			1-1/2" Diameter; Medium; 1/4–20 INT	
	051144-45100-5			1-1/2" Diameter; Hard; 1/4–20 INT	
	051144-45095-4			2" Diameter; Medium; 1/4–20 INT	25,000
	051144-45096-1			2" Diameter; Hard; 1/4–20 INT	
	051144-45092-3			3" Diameter; Medium; 1/4–20 INT	18,000
	051144-45091-6			3" Diameter; Hard; 1/4–20 INT	20,000
	051144-45179-1			4" Diameter; Medium; 1/4–20 INT	12,000
	051141-28474-3 NEW!			4" Diameter; Hard; 3/8–24 INT	
	051141-28475-0 NEW!			4" Diameter; Extra Hard; 3/8–24 INT	
	051144-83242-2			4" Diameter; Medium; 5/8–11 INT	
	051144-83489-1			4" Diameter; Hard; 5/8–11 INT	
	051144-83980-3			4" Diameter; Extra Hard; 5/8–11 INT	
	3M™ Roloc™ Cool Running Disc Pads 			051111-56479-0 NEW!	5
051141-28473-6 NEW!		4"; 5/8–11 INT			
3M™ Roloc™ TS or TSM Disc Pads 	051144-77729-7	5	3M™ Roloc™ TSM Discs and "screw on" abrasive discs	1-1/2"; Medium	30,000
	051144-77728-0			1-1/2"; Hard	
	051144-14211-8			2"; Medium	25,000
	051144-14212-5			2"; Hard	
	051144-14215-6			3"; Medium	18,000
	051144-14216-3			3"; Hard	20,000
3M™ Roloc™ TP Disc Pads	051144-14201-9	5	3M™ Roloc™ TP Discs	3"; Medium; 1/4–20 INT	18,000
	051144-14202-6			3"; Hard; 1/4–20 INT	20,000
1/4" Threaded Shaft 	051144-45102-9	10/50	Used on 3M™ Roloc™ Disc Pads with 1/4–20 INT	1/4" x 1/4–20 Thread	N/A

Accessories

Product Name	UPC	Qty./Case	For Use With	Size/Description	Max RPM	
3M™ Roloc™ Disc Accessories (cont.)						
3M™ Roloc™ + Holder  <small>51732</small>	048011-15408-4	5	3M™ Roloc™ Unitized Wheels, Roloc™+ Products, Brush and Disc Accessories	1" Diameter x 1/4" Shaft Diameter	25,000	
Scotch-Brite™ Light Grinding and Blending Disc Accessories						
3M™ Disc Pad Face Plates*  <small>51695</small>	051144-14270-5	10	Light Grinding and Blending Discs	4-1/2" Diameter; Smooth; Hard – Black	13,300	
	051141-28443-9 NEW!			4-1/2" Diameter; Ribbed; Extra Hard – Red		
	051144-81733-7			5" Diameter; Ribbed; Hard – Black	12,000	
	051144-81732-0			5" Diameter; Ribbed; Extra Hard – Red		
	051144-80515-0			7" Diameter; Ribbed; Hard – Black	8,600	
	051144-80514-3			7" Diameter; Ribbed; Extra Hard – Red		
3M™ Hook-and-Loop Disc Pad Holder 	051141-20245-7	1	Scotch-Brite™ Light Grinding and Blending Disc Accessories	7" x 7/8" Center Post; 5/8–11 INT	8,500	
Scotch-Brite™ Disc Accessories						
3M™ Hook-and-Loop Disc Pad Holders  <small>14470</small> Disc Pad Holder No. 922 and 923 <small>369359</small> Disc Pad Holder No. 924 <small>614622</small> Disc Pad Holder No. 914 <small>215543</small> Disc Pad Holder No. 9145 and 915 <small>51713</small> Disc Pad Holder No. 905 <small>14469</small> Disc Pad Holder No. 917 <small>636699</small> Disc Pad Holder No. 947TH <small>95288</small> Disc Pad Holder No. 918	048011-07494-8	10	Scotch-Brite™ Surface Conditioning Discs	2" (1/4" shank); Catalog No. 922	23,000	
	048011-04132-2			3" (1/4" shank); Catalog No. 923	20,000	
	048011-07492-4	5		4" (1/4" shank); Catalog No. 924	13,000	
	048011-05674-6	4" x 1/8" x 3/8" 5/8–11 INT; Catalog No. 914				
	048011-14111-4	4-1/2" x 5/8–11 INT; Catalog No. 9145				
	048011-05680-7	5" x 5/8–11 INT; Catalog No. 915		1	5" x 5/16–24 EXT; Catalog No. 905	10,000
	048011-09448-9	7" x 5/8–11 INT; Catalog No. 917			6,000	
	048011-09450-2	7" x 1" x 5/8–11 INT; Catalog No. 947TH				
	051141-20279-2	8" x 5/16" x 3/8" 5/8–11 INT; Catalog No. 918				





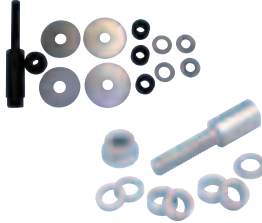
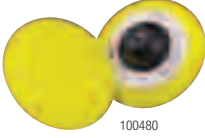
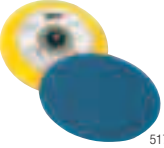

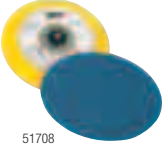

* Must be used with 3M™ Disc Pad Hubs. See page 72.

Accessories

Product Name	UPC	Qty./Case	For Use With	Size/Description	Max RPM	Max OPM
Scotch-Brite™ Disc Accessories (cont.)						
3M™ TN Quick Change Disc Backup Pad  352092	051111-56573-5	5	4-1/2" TN Discs	4-1/2" x 5/8–11 INT	13,300	N/A
Mandrels††  Mandrel No. 933 1/4" Shaft Dia. Mandrel No. 934 1/2" Shaft Dia.	048011-13968-5	5	Furnished complete with washers to fit available wheel and disc sizes††	Catalog No. 933; 2" x 1/4" x 1"	14,000	N/A
 Mandrel No. 933 or 934 Disc	048011-04021-9	1		Catalog No. 934; 3-1/16" x 1/4" x 2-1/2"	12,000	N/A
3M™ Wheel Adapter Kits 	051141-28419-4 NEW!	1	3M™ Inline Sanders; 4", 6", 8" Scotch-Brite™ Surface Conditioning Discs; Wheels with 1/2"–1" center holes	Part No. 28419; 1/2–20 EXT	See MOS of abrasive disc or wheel	N/A
	051144-45038-1 NEW!	1		Part No. 45038; 5/8–11 EXT		N/A
	048011-04019-6 NEW!	1		Part No. 300		N/A
3M™ Hookit™ Disc Accessories						
3M™ Hookit™ Disc Pad  100480	051131-05755-5	10	Scotch-Brite™ Coating Removal Discs	5" x 3/8" x 5/16–24 EXT	12,000	12,000
	051144-85096-9			5" x 5/8" x 5/8–11 INT	12,000	N/A
	051144-13625-4			5" x 3/4" x 5/16–24 EXT	10,000	12,000
	051144-85105-8			5 x 3/4" x 5/8–11 INT	12,000	N/A
	051144-13627-8			1	7" x 1" x 5/8–11 INT	6,000
3M™ Stikit™ Disc Accessories						
3M™ Stikit™ Disc Pads  51708	051131-05545-2	10	3M™ Stikit™ Discs	5" x 11/16" 5/16–24 EXT; Low Profile Finishing	12,000	12,000
	051131-05546-9			6" x 11/16" 5/16–24 EXT; Low Profile Finishing	10,000	12,000
	051131-05555-1			5" x 3/8" 5/16–24 EXT; Low Profile	12,000	12,000
	051131-05556-8			6" x 3/8" x 5/16–24 EXT; Low Profile	10,000	12,000
	051144-05575-3	1/10		5" x 3/4" x 5/16–24	10,000	12,000
	051144-05576-0			6" x 3/4" x 5/16–24		
	051144-05579-1	1		8" x 5/8–11 INT	3,000	N/A
	051111-55813-3	5		5" x 1/2" 5/8–11 INT	12,000	N/A
	051141-20351-5	10		5" x 3/8" x 5/16–24 EXT; Red Foam; Low Profile	12,000	12,000
	051141-20354-6			6" x 3/8" x 5/16–24 EXT; Red Foam; Low Profile	12,000	12,000

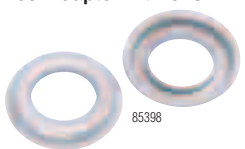
†† Also for use with Unitized Wheels.

Accessories

Product Name	UPC	Qty./Case	For Use With	Size/Description	Max RPM (Max OPM)
3M™ Stikit™ Disc Accessories (cont.)					
3M™ Stikit™ Disc Pads (cont.)  51708	051144-81821-1	10	3M™ Stikit™ Discs	5" x 3/4" 5/16–24 EXT	10,000 (12,000)
	051144-82189-1			5" x 3/4" 5/8–11 INT	12,000
	051144-88736-1			5" x 3/8" 5/16–24 EXT	10,000 (12,000)
3M™ PSA Disc Accessories					
PSA Disc Holder  51710	051144-45070-1	10	Any air or electric grinding tool that accommodates a 1/4" shank; Supports 248D/348D PSA disc	2" Diameter	15,000
	051144-05510-4			3" Diameter	10,000
	051144-45068-8	5		5" Diameter	6,000
Unitized Wheel Accessories					
Mandrels  Mandrel No. 936 51733 Mandrel No. 990 51734	048011-04018-9	5	Scotch-Brite™ Unitized Wheels	Mandrel No. 936 ; 2-1/16" x 1/4" x 3/4"	22,200
	048011-15012-3			Mandrel No. 990 with 3" wheel; 1-3/4" x 1/4" x 1"	18,200
Convolute Wheel Accessories					
Flange Adapter Kit No. 5  51738	048011-16859-3	1 Set	6" Wheels; Telescoping wheel adapters 1" and 1/2" wide to reduce 1" wheel cores to fit 1/2", 5/8", 3/4", or 7/8" shafts; Must be used with side flanges	1" x 1/2" x 1/2"	N/A
	048011-16860-9			1" x 1" x 1/2"	
Flap Wheel Accessories					
Wheel Adapter Kit No. 3  85398	051144-45035-0	1	Two arbor hole (plug type) adapters for 6" and 8" diameter flap wheels	1" OD x 1/2" ID	N/A
	051144-45034-3			1" OD x 5/8" ID	
	051144-45033-6			1" OD x 3/4" ID	
	051144-45032-9			1" OD x 7/8" ID	
Wheel Adapter Kit No. 81A  158320	051144-45081-7	1	For T84 Flap Wheels	1/4" x 1/4–20 INT	N/A
Star Accessories					
Mandrel No. 944  157990	048011-13928-9	1	Scotch-Brite™ Stars for cleaning and polishing internal diameters of pipe and tubing	1/4" x 1/4–20 EXT	25,100
Cross Buff Accessories					
3M™ Mandrel  158019	048011-14307-8	1	Scotch-Brite™ Cross Buffs for cleaning and polishing internal diameters of pipe and tubing	1/4" x 8–32 EXT	Dependent upon abrasive product used
Cartridge Roll Accessories					
3M™ Mandrels  51755	051144-45119-7	25	Screw-type mandrels for securing cartridge rolls to tool	1/8" x 1" x 1/4"	24,000 (1/2" and smaller cartridge roll diameter); 16,000 (5/8"–3/4" cartridge roll diameter)
	051144-45117-3			3/16" x 1" x 1/4"	
	051144-45118-0			3/16" x 1-1/2" x 1/4"	

Accessories

Product Name	UPC	Qty./Case	For Use With	Size/Description	Max RPM
Cross and Square Pad Accessories					
3M™ Square and Cross Pad Mandrel 	051144-14308-5	1	Used for holding square and cross pads with 1/4–20 and 8–32 internal threaded inserts	1/4" x 1/4–20 EXT	Dependent upon abrasive product used
	051144-14307-8			1/4" x 8–32 EXT	
	051141-28385-2	5		1/4" x 3–48 EXT	
Band and Belt Accessories					
Rubber Slotted Expander Wheels 	051144-77717-4	1	Slotted wheels for use with bands	1" x 1" x 1/4"	18,000
	051144-77718-1			1-1/2" x 1" x 1/4"	14,000
	051144-77720-4			2" x 1" x 1/4"	12,000
	051144-77721-1			2" x 2" x 1/4"	6,000
	051144-77722-8			3" x 3" x 5/8–INT	
	051141-28348-7			5" x 3-1/2" 5/8" Arbor Hole	3,500
	051141-28349-4			3-1/4" x 3" 5/8" Arbor Hole	
Rubber Cushion Polishing Wheels 	051144-45159-3	1	Use with bands when creating fine finishes	1/4" x 1/2" x 1/8"	23,000
	051144-45156-2			1/2" x 1/2" x 1/4"	30,000
	051144-45153-1			1/2" x 1" x 1/4"	15,000
	051144-45152-4			1/2" x 1-1/2" x 1/4"	
	051144-45145-6			3/4" x 1" x 1/4"	17,000
	051144-45144-9			3/4" x 1-1/2" x 1/4"	10,000
	051144-45139-5			1" x 1" x 1/4"	18,000
	051144-45138-8			1" x 1-1/2" x 1/4"	10,000
	051144-45132-6			1-1/2" x 1" x 1/4"	14,000
	051144-45131-9			1-1/2" x 1-1/2" x 1/4"	10,000
	051144-45130-2			1-1/2" x 2" x 1/4"	8,000
	051144-45129-6			2" x 1" x 1/4"	11,000
	051144-45127-2			2" x 2" x 1/4"	6,000
	051144-45124-1			3" x 3" x 3/8"	3,000
	051144-45123-4			3" x 3" x 1/2"	
Utility Cloth Sheet and Roll Accessories					
Forked Spindle 	051144-45121-0	10	For attaching utility cloth strips	1/4" x 3"	N/A
Wetordry™ Accessories					
3M™ Wetordry™ Sponge Pad	051131-05526-1	50	Wetordry™ Paper Sheets	2-3/4" x 5-1/2" x 3/8"	N/A
3M™ Stikit™ Soft Hand Pad	051144-05530-2	5/10	Stikit™ Sheet Rolls		
Scotch-Brite™ Hand Pad Accessories					
Scotch-Brite™ Pad Holder No. 961 	048011-09493-4	10	Scotch-Brite™ Hand Pads; Provides increased leverage and eliminates "finger" marks	3-1/2" x 4-3/4"	N/A
Scotch-Brite™ Roll Accessories					
Mini Mandrel No. 935 	048011-04020-2	5	Scotch-Brite™ Strips to clean and polish inner diameters and other tight areas	2-7/8" x 1/4"	14,000

2-Day Shipping
on stock wheels
within the U.S.!

The superabrasive products featured in this catalog are 3M's best, "go-to" wheels for cutting tool applications ranging from short runs and re-sharpening to "lights-out" and long production runs. All are in-stock, and are available for fast, two-day shipping within the U.S. **If you require an item that is not listed, please contact your 3M Customer Service Representative at 1-800-736-2500.**

Typical Abrasive Wheels Used for Round Tool Grinding

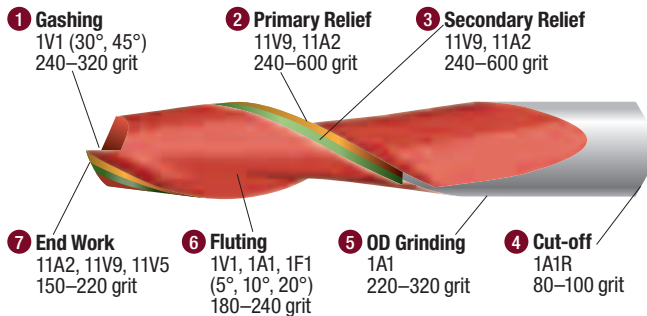

1 Gashing — Grinding a slot or notch along the cutting face to allow for chip flow.

2 Primary Relief — Removing material directly behind the cutting edge to provide clearance.

3 Secondary Relief — A slight bevel next to the primary relief.

4 Cut-off — Using a thin wheel to trim blanks to length. Typically used on the cutting end of the tool when re-grinding and on the shank end when forming a blank.

6 OD Grinding — Grinding to final diameter.

5 Fluting — Flutes are the helical or straight grooves in the body of the tool. This provides a pathway to permit the removal of chips, and to allow coolants to reach the cutting surface.

7 End Work — Grinding a small clearance, or relief angle, on the face (tip) of the tool.

When to use Diamond vs. CBN

For optimal grinding results, make sure you know what material the tools are made of.

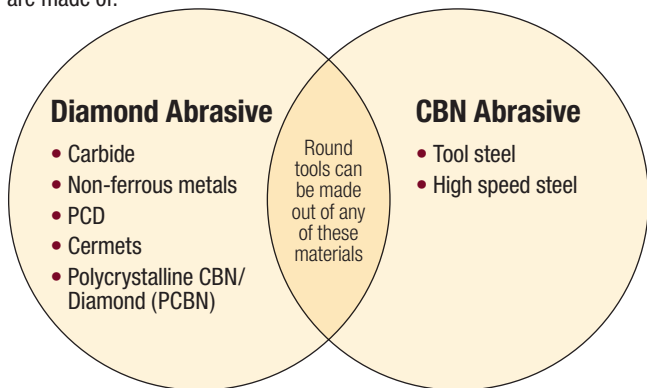

Can't find what you need?

Simply provide us with the following information, and we'll help you select the optimal product for your application.

Contact 3M Customer Service for more information.

E-mail	Fax	Phone
superabrasives@mmm.com	973-884-0392	800-736-2500

To order, specify: Wheel Shape, Dimension, Mineral, Grade and Product ID.

1. Are you manufacturing new tools or sharpening?

- Manufacturing Resharpening

2. What is your application?

- Fluting OD Grinding Step Grinding
 Gashing Primary Relief Other _____
 End Work Secondary Relief _____

3. What kind of material are you grinding?

- Carbide High Speed Steel Other _____

4. What type of equipment are you using?

- CNC Grinder Manual Tool & Cutter Other _____

If CNC Grinder...what is the model?

- ANCA—HP _____ Walters—HP _____ Other _____
 Rollomatic—HP _____ Tru Tech—HP _____ HP _____

5. What type of coolant are you using?

- Straight Oil Water Based Other _____
 Chilled? Yes No

6. What is the size/grade of your wheel(s)?

Shape	Diameter	Thickness	Hole	Grade
1F1				
1V1				
11A2				
12A2				
11V9				
12V9				
1A1R				
Other:				

Also Specify:

Radius: _____ Rim Width: _____
 Face Angle: _____ Rim Width: _____

7. What do you want to change/accomplish?

- Cut Faster Less Frequent Sticking Other _____
 Better Finishing Run Longer Without Re-truing

8. Which wheels have you tried?

Which 3M wheels in this brochure have you tested? _____

If none, what wheels do you currently use? _____

Fluting Wheel Performance Characteristics

3M has six standard constructions that are ideal for a variety different operations.

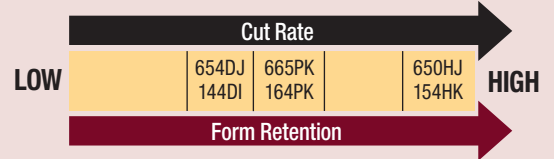

Product Performance (Diamond / CBN)		
654DJ / 144DI	665PK / 164PK	650HJ / 154HK
<ul style="list-style-type: none"> • Phenolic resin bond • Good cut rate/stock removal • Holds shape • Use for lower temperature operations • Can be run with water • Ideal for small re-grind shops or in-house re-sharpening 	<ul style="list-style-type: none"> • Polyimide resin bond • Higher cut rate/fast stock removal • Better form retention • Designed for higher temperature operations 	<ul style="list-style-type: none"> • Hybrid bond • Fastest cut rate • Best form retention • Designed for higher temperature operations than polyimide bond • Reduced frequency of dressing and minimal "white sticking" required • Ideal for long, uninterrupted runs

3M™ Fluting Wheels

2-Day Shipping
on stock wheels within the U.S.!

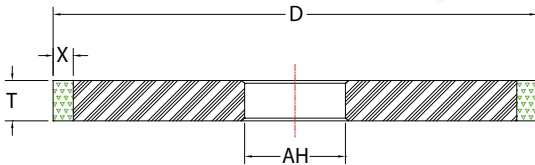

3M™ Fluting Wheel — Shape 1A1

Dimensions D × T × AH*	Grade	Bond**	Prod ID	UPC (051141-)	Min./ Case
Diamond Abrasive — 1A1					
4" × 1/4" × AH* X = 3/8	D220	H	650HJ	31270-5	1
		P	665PK	54806-7	
		R	654DJ	31288-0	
4" × 3/8" × AH* X = 3/8	D220	H	650HJ	31273-6	
		P	665PK	54809-8	
		R	654DJ	31291-0	
4" × 1/2" × AH* X = 3/8	D220	H	650HJ	31267-5	
		P	665PK	54803-6	
		R	654DJ	31285-9	
5" × 1/4" × AH* X = 3/8	D220	H	650HJ	31279-8	
		P	665PK	54823-4	
		R	654DJ	31297-2	
5" × 3/8" × AH* X = 3/8	D220	H	650HJ	31282-8	
		P	665PK	54828-9	
		R	654DJ	54800-5	

* Arbor hole is made to customer spec. Please specify on order.

** H=Hybrid P=Polyimide R=Resin

3M™ Fluting Wheel — Shape 1A1 (cont.)

Dimensions D × T × AH*	Grade	Bond**	Prod ID	UPC (051141-)	Min./ Case	
Diamond Abrasive — 1A1 (cont.)						
5" × 1/2" × AH* X = 3/8	D220	H	650HJ	31276-7	1	
		P	665PK	54820-3		
		R	654DJ	31294-1		
5" × 3/4" × AH* X = 3/8	D220	H	650HJ	54916-3		
		P	665PK	54917-0		
		R	654DJ	54918-7		
6" × 1/2" × AH* X = 3/8	D220	H	650HJ	55462-4		
		P	665PK	55464-8		
		R	654DJ	55463-1		
CBN Abrasive — 1A1						
4" × 1/2" × AH* X = 3/8	B180	H	154HK	55465-5		1
		P	164PK	55466-2		
		R	144DI	55467-9		
5" × 1/2" × AH* X = 3/8	B180	H	154HK	55468-6		
		P	164PK	55469-3		
		R	144DI	55470-9		
6" × 1/2" × AH* X = 3/8	B180	H	154HK	55471-6		
		P	164PK	55472-3		
		R	144DI	55473-0		

* Arbor hole is made to customer spec. Please specify on order.

** H=Hybrid P=Polyimide R=Resin

The wheels listed in this catalog are in stock and intended as a general starting point for the application indicated. **These wheels are recommended for wet applications.** For dry applications or wheel configurations/grades not listed here, please contact your 3M Customer Service Representative at 1-800-736-2500.

Flute Grinding

Flutes are the helical or straight grooves in the body of the tool. This provides a pathway to permit the removal of chips, and to allow coolants to reach the cutting surface.

2-Day Shipping
on stock wheels
within the U.S.!

3M™ Fluting Wheels (cont.)

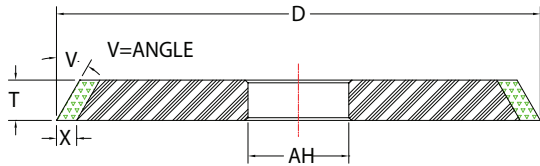

3M™ Fluting Wheel — Shape 1V1

Dimensions D × T × AH*	Grade	Bond**	Prod ID	UPC (051141-)	Min./ Case
Diamond Abrasive — 1V1					
4" × 1/4" × AH* X = 3/8 V = 10°	D220	H	650HJ	31268-2	1
		P	665PK	54804-3	
		R	654DJ	31286-6	
4" × 1/4" × AH* X = 3/8 V = 20°		H	650HJ	31269-9	
		P	665PK	54805-0	
		R	654DJ	31287-3	
4" × 3/8" × AH* X = 3/8 V = 10°		H	650HJ	31271-2	
		P	665PK	54807-4	
		R	654DJ	31289-7	
4" × 3/8" × AH* X = 3/8 V = 20°		H	650HJ	31272-9	
		P	665PK	54808-1	
		R	654DJ	31290-3	
4" × 1/2" × AH* X = 3/8 V = 10°	H	650HJ	31265-1		
	P	665PK	54801-2		
	R	654DJ	31283-5		
4" × 1/2" × AH* X = 3/8 V = 20°	H	650HJ	31266-8		
	P	665PK	54802-9		
	R	654DJ	31284-2		
5" × 1/4" × AH* X = 3/8 V = 10°	H	650HJ	31277-4		
	P	665PK	54821-0		
	R	654DJ	31295-8		
5" × 1/4" × AH* X = 3/8 V = 20°	H	650HJ	31278-1		
	P	665PK	54822-7		
	R	654DJ	31296-5		

* Arbor hole is made to customer spec. Please specify on order.
** H=Hybrid P=Polyimide R=Resin

3M™ Fluting Wheel — Shape 1V1 (cont.)

Dimensions D × T × AH*	Grade	Bond**	Prod ID	UPC (051141-)	Min./ Case
Diamond Abrasive — 1V1 (cont.)					
5" × 3/8" × AH* X = 3/8 V = 10°	D220	H	650HJ	31280-4	1
		P	665PK	54826-5	
		R	654DJ	31298-9	
5" × 3/8" × AH* X = 3/8 V = 20°		H	650HJ	31281-1	
		P	665PK	54827-2	
		R	654DJ	31299-6	
5" × 1/2" × AH* X = 3/8 V = 10°		H	650HJ	31274-3	
		P	665PK	54818-0	
		R	654DJ	31292-7	
5" × 1/2" × AH* X = 3/8 V = 20°		H	650HJ	31275-0	
		P	665PK	54819-7	
		R	654DJ	31293-4	
5" × 3/4" × AH* X = 3/8 V = 10°	H	650HJ	54919-4		
	P	665PK	54920-0		
	R	654DJ	54921-7		
CBN Abrasive — 1V1					
4" × 1/2" × AH* X = 3/8 V† = 0°–20°	B180	H	154HK	55474-7	1
		P	164PK	55475-4	
		R	144DI	55476-1	
5" × 1/2" × AH* X = 3/8 V† = 0°–20°		H	154HK	55477-8	
		P	164PK	55478-5	
		R	144DI	55479-2	
6" × 1/2" × AH* X = 3/8 V† = 0°–20°		H	154HK	55480-8	
		P	164PK	55481-5	
		R	144DI	55482-2	

* Arbor hole is made to customer spec. Please specify on order.
** H=Hybrid P=Polyimide R=Resin

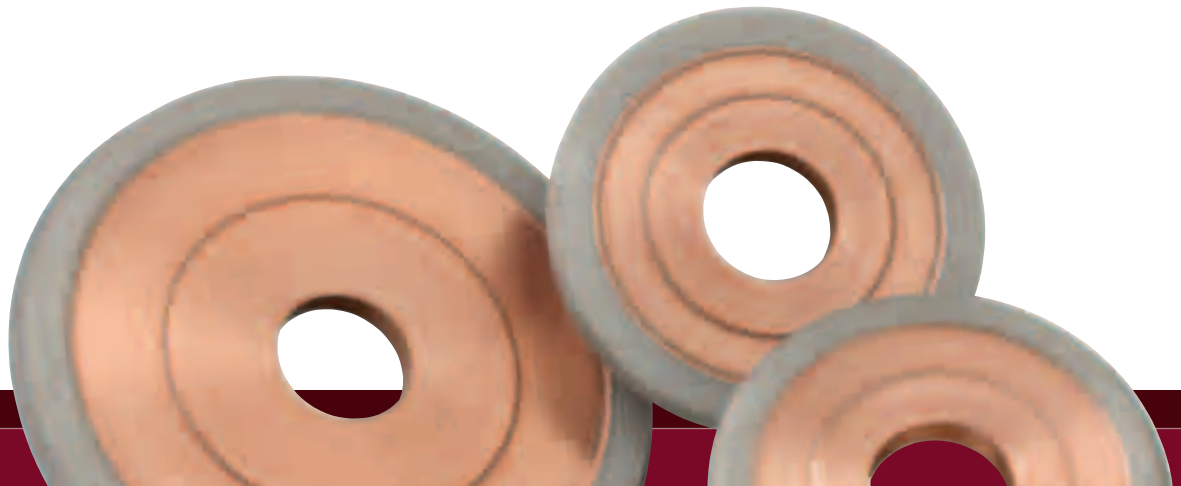

Wheel Performance Characteristics

3M™ Superabrasive Wheels are available in a variety of constructions, each with its own unique characteristics. Choose the 3M Wheel with the best balance of form retention and cut rate for your application.

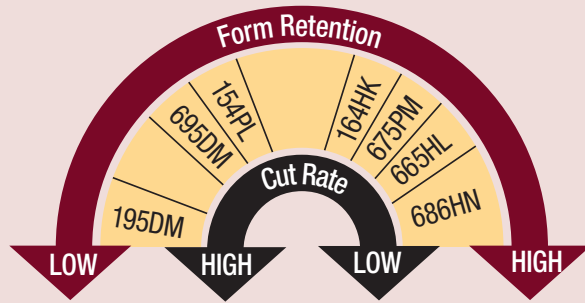

- Less Form Retention
 - Shorter Production Runs
 - Free Cutting
 - Fast Cutting
- Best Form Retention
 - Close Tolerances
 - Long Wheel Life
 - Long Production Runs
 - Slower Cut Rate



The wheels listed in this catalog are in stock and intended as a general starting point for the application indicated. **These wheels are recommended for wet applications.** For dry applications or wheel configurations/grades not listed here, please contact your 3M Customer Service Representative at 1-800-736-2500.

3M™ Primary and Secondary Relief Wheels

2-Day Shipping
on stock wheels
within the U.S.!

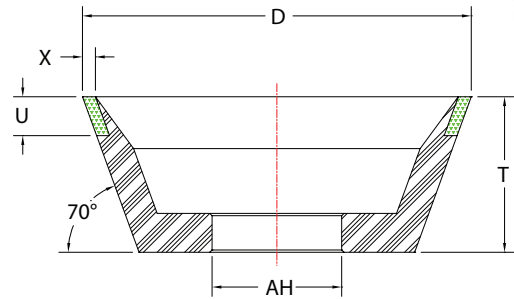

3M™ Primary and Secondary Relief Wheel — Shape 11V9

Dimensions D × T × AH*	Grade	Bond**	Prod ID	UPC (051141-)	Min./ Case
Diamond Abrasive — 11V9					
3-3/4" × 1-1/2" × AH* X = 1/8 U = 3/8	D220	H	686HN	54864-7	1
		P	675PM	54837-1	
		R	695DM	54869-2	
	D280	H	686HN	54865-4	
		P	675PM	54838-8	
		R	695DM	54870-8	
	D320	H	686HN	54866-1	
		P	675PM	54839-5	
		R	695DM	54871-5	
	D400	H	686HN	54867-8	
		P	675PM	54840-1	
		R	695DM	54872-2	
5" × 1-3/4" × AH* X = 1/8 U = 7/16	D220	H	686HN	54927-9	
	D320	H	686HN	54868-5	
		P	675PM	54855-5	
		R	695DM	54887-6	
CBN Abrasive — 11V9					
3-3/4" × 1-1/2" × AH* X = 1/8 U = 3/8	B220	H	164HK	31244-6	1
		P	154PL	31233-0	
		R	195DM	31254-5	
5" × 1-3/4" × AH* X = 1/8 U = 7/16		H	164HK	31251-4	
		P	154PL	31239-2	
		R	195DM	31261-3	

* Arbor hole is made to customer spec. Please specify on order.

** H=Hybrid P=Polyimide R=Resin

Primary and Secondary Relief Grinding

Cutting edges are typically "relieved" to enhance chip clearance. Primary relief involves removing material directly behind the cutting edge. For secondary relief, a slight bevel is ground next to the primary relief.

3M™ Primary and Secondary Relief Wheels (cont.)

2-Day Shipping
on stock wheels
within the U.S.!

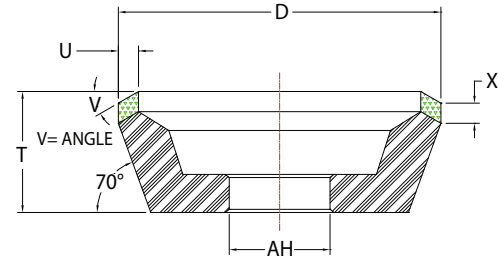
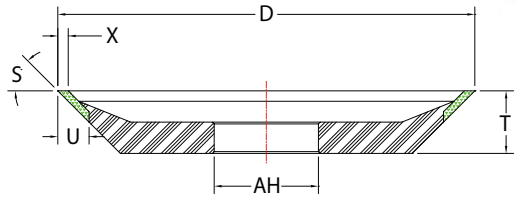

3M™ Primary and Secondary Relief Wheel — Shape 12V9

- Can also be used for gashing.
(See page 83 for additional Gashing Wheels)

Dimensions D × T × AH*	Grade	Bond**	Prod ID	UPC (051141-)	Min./ Case	
Diamond Abrasive — 12V9						
4" × 3/4" × AH* X = 1/8; U = 3/8 S = 30°	D320	H	665HL	54814-2	1	
		P	675PM	54847-0		
		R	695DM	54879-1		
4" × 3/4" × AH* X = 1/8; U = 3/8 S = 45°		H	665HL	54813-5		
		P	675PM	54846-3		
		R	695DM	54878-4		
5" × 3/4" × AH* X = 1/8; U = 3/8 S = 30°		H	665HL	54831-9		
		P	675PM	54856-2		
		R	695DM	54888-3		
5" × 3/4" × AH* X = 1/8; U = 3/8 S = 45°	H	665HL	54832-6			
	P	675PM	54857-9			
	R	695DM	54889-0			
CBN Abrasive — 12V9						
4" × 3/4" × AH* X = 1/8; U = 3/8 S = 30°	B220	H	164HK	31250-7	1	
		P	154PL	31236-1		
		R	195DM	31258-3		
4" × 3/4" × AH* X = 1/8; U = 3/8 S = 45°		R	195DM	31257-6		
		5" × 3/4" × AH* X = 1/8; U = 3/8 S = 30°	H	164HK		31252-1
			P	154PL		31240-8
R			195DM	31262-0		
5" × 3/4" × AH* X = 1/8; U = 3/8 S = 45°		H	164HK	31253-8		
		P	154PL	31241-5		
	R	195DM	31263-7			

* Arbor hole is made to customer spec. Please specify on order.

** H=Hybrid P=Polyimide R=Resin

3M™ Primary and Secondary Relief Wheel — Shape 11V5

- Can also be used for gashing.
(See page 83 for additional Gashing Wheels)

Dimensions D × T × AH*	Grade	Bond**	Prod ID	UPC (051141-)	Min./ Case
Diamond — 11V5					
4" × 1-1/2" × AH* X = 1/4; U = 1/4 V = 30°	D320	H	665HL	54895-1	1
		P	675PM	54894-4	
		R	695DM	54893-7	

* Arbor hole is made to customer spec. Please specify on order.

** H=Hybrid P=Polyimide R=Resin

Wheel Performance Characteristics

3M™ Superabrasive Wheels are available in a variety of constructions, each with its own unique characteristics. Choose the 3M Wheel with the best balance of form retention and cut rate for your application.

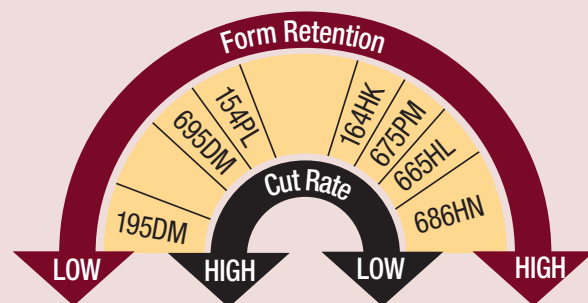

- | | |
|--|---|
| <ul style="list-style-type: none"> • Less Form Retention • Shorter Production Runs • Free Cutting • Fast Cutting | <ul style="list-style-type: none"> • Best Form Retention • Close Tolerances • Long Wheel Life • Long Production Runs • Slower Cut Rate |
|--|---|

3M™ Gashing Wheels

2-Day Shipping
on stock wheels
within the U.S.!

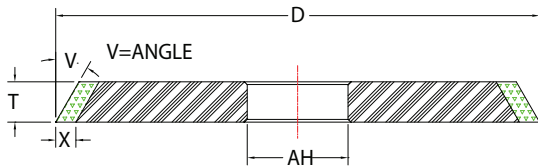

3M™ Gashing Wheel — Shape 1V1

- Wheel shapes 12V9 and 11V5 are also commonly used for gashing. (See page 82)

Dimensions D × T × AH*	Grade	Bond**	Prod ID	UPC (051141-)	Min./ Case
Diamond Abrasive — 1V1					
4 × 1/4 × AH* X = 3/8 V = 30°	D280	H	665HL	54810-4	1
		P	675PM	54842-5	
		R	695DM	54875-3	
4 × 3/8 × AH* X = 3/8 V = 20°	D320	H	665HL	54815-9	1
		P	675PM	54848-7	
		R	695DM	54880-7	
4 × 3/8 × AH* X = 3/8 V = 30°	D320	H	665HL	54816-6	1
		P	675PM	54849-4	
		R	695DM	54881-4	
4 × 3/8 × AH* X = 3/8 V = 45°	D320	H	665HL	54817-3	1
		P	675PM	54850-0	
		R	695DM	54882-1	
5 × 3/8 × AH* X = 3/8 V = 20°	D320	H	665HL	54833-3	1
		P	675PM	54858-6	
		R	695DM	54890-6	
5 × 3/8 × AH* X = 3/8 V = 30°	D320	H	665HL	54834-0	1
		P	675PM	54859-3	
		R	695DM	54891-3	
5 × 3/8 × AH* X = 3/8 V = 45°	D320	H	665HL	54835-7	1
		P	675PM	54860-9	
		R	695DM	54926-2	
6 × 3/8 × AH* X = 3/8 V = 30°	D280	H	665HL	54836-4	1
		P	675PM	54861-6	
		R	695DM	54892-0	

* Arbor hole is made to customer spec. Please specify on order.

** H=Hybrid P=Polyimide R=Resin



3M™ Gashing Wheel — Shape 1V1 (cont.)

Dimensions D × T × AH*	Grade	Bond**	Prod ID	UPC (051141-)	Min./ Case
CBN Abrasive — 1V1					
4 × 3/8 × AH* X = 3/8 V = 30°	B220	P	154PL	31237-8	1
		R	195DM	31259-0	
4 × 3/8 × AH* X = 3/8 V = 45°	B220	P	154PL	31238-5	1
		R	195DM	31260-6	
5 × 3/8 × AH* X = 3/8 V = 30°	B220	P	154PL	31242-2	1
		R	195DM	31264-4	
5 × 3/8 × AH* X = 3/8 V = 45°	B220	P	154PL	31243-9	1
		R	195DM	31264-4	

* Arbor hole is made to customer spec. Please specify on order.

** H=Hybrid P=Polyimide R=Resin

The wheels listed in this catalog are in stock and intended as a general starting point for the application indicated. **These wheels are recommended for wet applications.** For dry applications or wheel configurations/grades not listed here, please contact your 3M Customer Service Representative at 1-800-736-2500.

Gashing

Gashing involves grinding a slot or notch along the cutting face to allow for chip flow.

2-Day Shipping
on stock wheels
within the U.S.!

3M™ Wheels for End Work

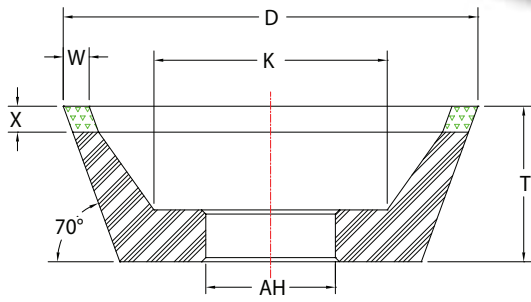

3M™ Wheel for End Work — Shape 11V2

Dimensions D × T × AH*	Grade	Bond**	Prod ID	UPC (051141-)	Min./ Case
Diamond Abrasive — 11V2					
4" × 1-1/2" × AH* X = 1/4 W = 1/4	D220	H	665HL	54862-3	1
		P	675PM	54841-8	
		R	695DM	54873-9	
	D320	H	665HL	54863-0	
		P	675PM	54843-2	
		R	695DM	54876-0	
CBN Abrasive — 11V2					
4" × 1-1/2" × AH* X = 1/4 W = 1/4	B220	H	164HK	31248-4	1
		P	154PL	31234-7	
		R	195DM	31255-2	

* Arbor hole is made to customer spec. Please specify on order.

** H=Hybrid P=Polyimide R=Resin



End Work

Grinding a small clearance, or relief, angle on the face (tip) of the tool to reduce the contact area between the tool and workpiece.

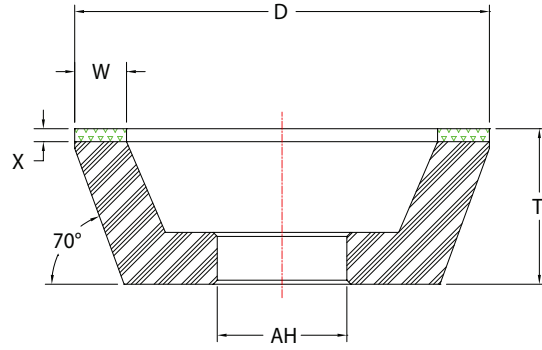

3M™ Wheel for End Work — Shape 11A2

Dimensions D × T × AH*	Grade	Bond**	Prod ID	UPC (051141-)	Min./ Case	
Diamond Abrasive — 11A2						
4" × 1-1/4" × AH* X = 1/4 W = 1/4	D320	H	665HL	54811-1	1	
		P	675PM	54844-9		
		R	695DM	54922-4		
4" × 1-1/4" × AH* X = 1/4 W = 3/8	D220	R	695DM	54874-6		
		D320	H	665HL		54812-8
			P	675PM		54845-6
R	695DM		54877-7			
5" × 1-1/2" × AH* X = 1/4 W = 1/4	D220	H	665HL	54824-1		
		P	675PM	54851-7		
		R	695DM	54883-8		
	D320	H	665HL	54829-6		
		P	675PM	54853-1		
		R	695DM	54885-2		
5" × 1-1/2" × AH* X = 1/4 W = 3/8	D220	H	665HL	54825-8		
		P	675PM	54852-4		
		R	695DM	54884-5		
	D320	H	665HL	54830-2		
		P	675PM	54854-8		
		R	695DM	54886-9		
CBN Abrasive — 11A2						
4" × 1-1/4" × AH* X = 1/4 W = 1/4	B220	H	164HK	31249-1		
		P	154PL	31235-4		
		R	195DM	31256-9		
4" × 1-1/4" × AH* X = 1/4 W = 3/8	B220	H	164HK	54923-1		
		P	154PL	54924-8		
		R	195DM	54925-5		

* Arbor hole is made to customer spec. Please specify on order.

** H=Hybrid P=Polyimide R=Resin

The wheels listed in this catalog are in stock and intended as a general starting point for the application indicated. Many other wheel configurations and grades are available. Contact your 3M Customer Service Representative at 1-800-736-2500.

Cut-Off Wheel Performance Characteristics

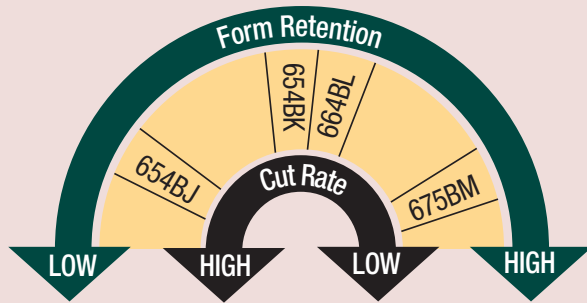

- | | |
|--|---|
| <ul style="list-style-type: none"> • Less Form Retention • Shorter Production Runs • Free Cutting • Fast Cutting | <ul style="list-style-type: none"> • Best Form Retention • Close Tolerances • Long Wheel Life • Long Production Runs • Slower Cut Rate |
|--|---|



Cut-Off Wheels

These thin abrasive wheels are used to trim blanks to length. They are typically used on the cutting end of the tool when re-grinding and on the shank end when forming a blank.

3M™ Cut-Off Wheels

2-Day Shipping on stock wheels within the U.S.!

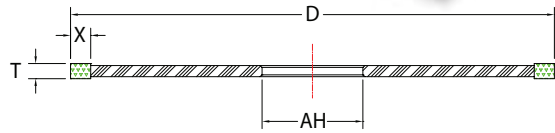

3M™ Cut-Off Wheel — Shape 1A1R

- Thin abrasive wheels used to trim blanks to length
- Typically used on the cutting end of the tool when re-grinding and on the shank end when forming a blank

Dimensions D × T × AH	Grade	Prod ID	UPC (051141-)	Min./ Case
Diamond Abrasive — 1A1R				
6" × 0.35" × 1-1/4" X = 1/4	D100	654BJ	54951-4	1
		654BK	30581-3	
		675BM	54952-1	
	D120	664BL	54953-8	
	D220	654BJ	54954-5	

3M™ Truing and Dressing Products

3M™ Dressing Wheels

- Silicon carbide dressing wheels are used to true and dress superabrasive grinding wheels
- Ideally suited for use with 3M™ Truing and Dressing Machines



2-Day Shipping on stock wheels within the U.S.!

Dimensions D × T × AH	Grade*	Prod ID	UPC (051141-)	Min./ Case
Silicon Carbide Abrasive				
8" × 1/2" × 1-1/4"	C80	400TI	54900-2	1
	GC80	400TI	54906-4	
8" × 1/4" × 1-1/4"	C80	400TI	54901-9	
		400TK	54910-1	
	GC80	400TI	54907-1	
		400TG	54896-8	
		400TH	54898-2	
	GC220	400TI	54905-7	
8" × 3/4" × 1-1/4"	C80	400TI	54902-6	
		400TK	54911-8	
8" × 3/8" × 1-1/4"	GC80	400TI	54908-8	
		400TK	54903-3	
		400TH	54912-5	
	GC120	400TG	54899-9	
		400TI	54897-5	
		400TI	54909-5	
		400TI	54904-0	

*GC = Green Silicon Carbide — Premium quality for longer life.
C = Black Silicon Carbide — Standard quality, softer construction provides freer and faster cut.

3M™ Truing and Dressing Products (cont.)

3M™ DSD Truing Tools

- Made of a 3M proprietary alloy
- Excellent for truing resin bond diamond and CBN wheels
- Will true straight ODs, angles or sides of wheels
- Must be used without coolant



Size D x L	Application	UPC (051115-)	Min./Case
1/4" x 1-3/4"	For use with 3M™ Holding Blocks	20817-1	1
3/8" x 1-3/4"		20818-8	
1/2" x 2"		20819-5	
5/8" x 2"		20820-1	

3M™ Holding Blocks

- Used to mount 3M™ DSD Truing Tools for truing resin bond diamond and CBN wheels



Size	Application	UPC (051115-)	Min./Case
For 1/4" or 3/8" diameter tools	Standard-Duty	20821-8	1
For 3/8" or 1/2" diameter tools	Heavy-Duty	20822-5	

3M™ Dressing Sticks

- The most common means of dressing superabrasive wheels
- Made of aluminum oxide or silicon carbide in popular sizes



Dimensions D x T x AH	Grade	Prod ID	UPC (051141-)*	Min./Case
Aluminum Oxide				
1/2" x 1/2" x 4"	A0500	200TK	54914-9	1
1/2" x 1/2" x 4"	A0220	200TH	20807-2*	
3/4" x 3/4" x 4"	A0150	200TG	20808-9*	
3/4" x 3/4" x 4"	A0500	200TK	54915-6	
1" x 1" x 6"	A0220	200TH	20809-6*	
Silicon Carbide				
1/2" x 1/2" x 3"	SC320	200TI	54913-2	1

*Order using prefix 051115.

3M™ Single-Point Dressing Tool — Standard

- A standard-quality natural diamond tip set in a steel shank
- Non-resettable, general purpose dresser



Shank D x L	Carat Weight	Type	UPC (051115-)	Min./Case
Standard Grade Diamond Abrasive; 45° Angle				
3/8" x 2"	.25 ct	TR2S6	20793-8	1
	.33 ct	TR3S6	20795-2	
	.50 ct	TR5S6	20797-6	
	.75 ct	TR7S6	20799-0	
	1.00 ct	TR10S6	20801-0	
7/16" x 2"	.25 ct	TR2S7	20794-5	
	.33 ct	TR3S7	20796-9	
	.50 ct	TR5S7	20798-3	
	.75 ct	TR7S7	20800-3	
	1.00 ct	TR10S7	20802-7	

3M™ Single-Point Dressing Tool — Premium

- A premium-quality natural diamond tip set in a steel shank
- Non-resettable tool is more durable than the standard-quality version
- Used on ceramic grain wheels and other difficult-to-dress wheels



Shank D x L	Carat Weight	Type	UPC (051115-)	Min./Case
Premium Grade Diamond Abrasive; 45° Angle				
3/8" x 2"	.33 ct	TR3P6	20803-4	1
	.50 ct	TR5P6	20805-8	
7/16" x 2"	.33 ct	TR3P7	20804-1	
	.50 ct	TR5P7	20806-5	

3M™ Truing and Dressing Products (cont.)

3M™ Multi-Point Diamond Dresser

- Contains whole natural diamonds
- Used in severe dressing applications for heavy stock removal
- For straight dressing where single-point tools are not economical



Head Diameter	Carat Weight	Description	UPC (051115-)	Min./Case
Type Jr.				
1/2"	3 ct	Used on 7" and 8" wheels	28466-3	1
Type 2 and 8				
5/8"	6 ct	Used on a #2 Cincinnati centerless, using an 8" wheel	28465-6	1
Type CC				
1"	6 ct	Used on centerless, cylindrical, and surface grinders, using wheels 10" in diameter or larger	28464-9	1

3M™ Multi-Point Dressing Tool

- Five or seven high-quality diamonds configured in a single layer; metal bond matrix
- For dressing applications requiring the highest removal rates



Shank D x L	Type	UPC (051141-)	Min./Case
7/16" x 1"	 CL5S1 Diamond Cluster 4 Eq Sp & 1 in. Center	20788-4	1
	 CL7S1 Diamond Cluster 6 Eq Sp & 1 in. Center	20789-1	

3M™ Impregnated Grit Dressing Tool

- Durable diamond grit in a metal bond matrix in straight or offset configurations
- Designed for common dressing applications

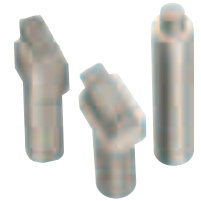

Size	Type	UPC (051141-)	Min./Case
15° Angle			
1/2" x 1/4" x 3/8" (7/16" Shank Dia.)	2A6E7 	20781-5	1
3/4" x 1/4" x 5/16" (7/16" Shank Dia.)	1A6C7 	20783-9	
Straight			
1/2" x 1/4" x 3/8" (7/16" Shank Dia.)	2A6D7 	20782-2	1
3/4" x 1/4" x 5/16" (7/16" Shank Dia.)	1A6A7 	20784-6	
Cylindrical, Straight Round			
1/4" x 3/8" (7/16" x 1-1/2" Shank)	1R6J7 	20786-0	1
3/8" x 1/2" (7/16" x 1-1/2" Shank)	2R6K7 	20787-7	

Abrasive Grade Comparison Guide

Ind'l Mesh-ANSI	FEPA "P"	Trizact™	Micron (μ)	Scotch-Brite™ Grade*
12				
	P12			
	P16			
16				
	P20			
20				
	P24			
24				
	P30			
30				
36				
	P36			
40				
	P40			
50		A500		
	P50			
60		A400		
	P60			
	P80	A300		
80			180	
	P100	A200	150	
100				Extra Coarse
	P120	A160	120	
120				Coarse
	P150	A130	100	
150		A110		Medium
180	P180	A100	80	
220				
	P220	A90		
		A80	60	
	P240	A75		
240		A65		Fine
	P280			
		A60	50	
	P320			
280			40	
	P360			
320				Very Fine
	P400	A45	35	
	P500		30	
360				
400	P600	A30		
	P800	A25	22	
			20	
500				
	P1000	A20	18	
600				Super Fine
	P1200	A16		
			15	
	P1500	A10		
800			12	
	P2000		10	
1000				Ultra Fine
			9	
	P2500			
		A7		
1200		A6		
		A5	5	Microfine
1500		A3	3	
2000			1	

Scotch-Brite™ Product Guide

Density Number (prefix to mineral)

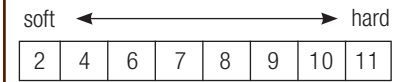

Mineral Abbreviations (prefix to grade)

- A—Aluminum Oxide mineral
- S—Silicon Carbide mineral
- T—Talc mineral

Grade Abbreviations

- ULF—Ultra Fine
- SFN—Super Fine
- VFN—Very Fine
- FIN—Fine
- MED—Medium
- CRS—Coarse
- XCS—Extra Coarse

Example:

2S MED = Soft Density,
Silicon Carbide Mineral,
Medium Grade

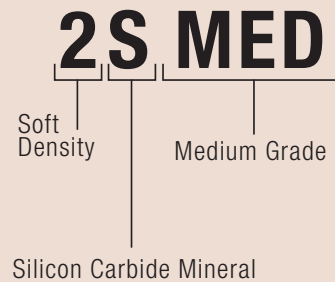

Measurement Conversions:

- 1 inch = 25.4 millimeters
- 1 millimeter = 0.039370 inches
- 1 micron (μ) = 0.000039 inches

ANSI—American National Standards Institute

FEPA—Federation of European Producers of Abrasives Products

*Scotch-Brite™ Surface Conditioning Grade (Generates finish approximately equivalent to indicated coated abrasive grade.)

3M™ Adhesive Selection Guide

	Structural Adhesives: Each adhesive has high cohesive strength to bond high strength materials and potentially replace mechanical fasteners.		Non-Structural Adhesives	
Metal to:	3M™ Scotch-Weld™ Epoxy, Acrylic Adhesives	3M™ Scotch-Weld™ Instant Adhesives	3M™ Scotch-Weld™ Adhesives	3M™ Aerosol Adhesives
Metal	Acrylics, Epoxies	CA40H	1357, 1099 (All), 1300	80, 90
EPDM Rubber	—	CA40H	4799	—
Rubber (except EPDM)	Flexible 2-part Epoxies	CA40H	1300, 847	80, 90*
Glass and Ceramics	Flexible 2-part Epoxies	—	1357	80, 90
Leather	Flexible 2-part Epoxies	—	847	80
Plastics (Polyolefins)	DP8005	—	—	90
Plastics (ABS, PVC, Acrylic, etc.)	DP8005	CA40H	1357	77, 80, 90
Plastics (High Performance Nylon)	DP460	CA40H	1099 (All)	77, 80, 90
Plastics (Flexible Vinyl)	Flexible 2-part Epoxies	CA40H	1099 (All)	80
Paper and Cardboard	2-part Epoxies	—	10	77
Fabric, Felt, Cork and Fibrous Glass	2-part Epoxies	—	—	74, 77, 80, 90
Flexible Foam (Latex, Urethane)	—	—	—	74, 90
Rigid Foam (Beadboard, Styrene)	Flexible 2-part Epoxies	—	—	—
Rigid Foam (Urethane)	Flexible 2-part Epoxies	CA40H	1357, 5, 10	74, 80

Note: The technical information and data on these pages should be considered representative or typical only and should not be used for specification purposes. Final product selection should be made only after consideration of a variety of factors and evaluations of sample bonds.

*Produces a temporary bond on these materials. (1) Adhesives must be force dried and bonded while warm. (2) For best results, preheat the substrate to a minimum of 120°F (49°C). (3) Evaluate usage surface activator.





3M™ Non-Structural Adhesives

3M™ Aerosol Adhesives

Only a finger's touch puts a job-matched formulation to work on paper, plastic, cardboard, foam, metal and more. 3M Aerosol Adhesives contain no methylene chloride, chlorofluorocarbons (CFCs), or 1,1,1-trichloroethane (methyl chloroform) and are California compliant.



399143

Product Number/Description	Spray Width	Bonding Range Surfaces One/Both	(PSI) Shear ¹ Initial/Ultimate	Relative Adhesion		Coverage Sq. Ft/ Container ⁴ (Typical)	Color	Size	UPC (021200-)	Qty./ Case	
				Peel Strength (PIW) ²	Temperature Resistant ³						
3M™ FoamFast 74 Spray Adhesive											
 <ul style="list-style-type: none"> Fast tack with foam-tearing strength Soft, non-dimpling glue line General upholstery foam bonding Knife edge bonding, boxing, edge turning Bonds flexible urethane or latex foam together or to wood, metal and plastic 	1" – 4" variable	N/R/ 15 min.	40/205	20	120°F (49°C)	260	Inverted Orange	24 fl. oz. can	07277-6	12	
							Clear				50045-9
							Original Formula Orange				96316-2*
3M™ Super 77™ Multipurpose Spray Adhesive											
 <ul style="list-style-type: none"> Fast, aggressive tack for bonding many lightweight materials High coverage Low soak-in for long lasting bonds Bonds gaskets in water pumps, and attaches insulation to sheet metal 	1-1/2" – 4" fan	15 min./ 30 min.	25/160	15	110°F (43°C)	220	Original Formula	24 fl. oz. can	96315-5*	12	
							Low Mist				21210-9
3M™ Rubber & Vinyl 80 Spray Adhesive											
 <ul style="list-style-type: none"> Neoprene-based contact adhesive with plasticizer resistance Adheres stainless steel panels, stiffeners, metal kick plates, leather and most supported vinyl, plastics, laminates, wood products and rubbers (except EPDM) 	3"	N/R/ 1 hr.	50/400	35	200°F (93°C)	75/30 ⁴	—	24 fl. oz. can	82618-4	6	
3M™ Hi-Strength 90 Spray Adhesive											
 <ul style="list-style-type: none"> High contact bond for decorative laminate Adheres to polyethylene and polypropylene to wood, metal and more One minute dry time 	1" – 4" variable	N/R/ 15 min.	45/230	25	160°F (71°C)	100	—	24 fl. oz. can	07278-3	12	

1 ATD T.M. C-700: 1/8" birch veneer bonded to 1/8" birch veneer

2 ATD T.M. C-449

3 ATD T.M. C-483: 500 g load for 1 hr. at noted temperature

4 Plastic laminate bonding @ 3-5 g/sq. ft. coverage







5 Coverage based on container sizes 24 fluid ounce or 16 fluid ounce size cans

N/R = Not Recommended

* NOT FOR SALE IN CALIFORNIA

3M™ Non-Structural Adhesives (cont.)

3M™ Scotch-Weld™ Plastic Adhesives: The Scotch-Weld™ Adhesive is a tool designed adhesive designed to provide innovative answers to a wide variety of non-structural bonding problems.

Product Number/Description	Solids Weight (Approx.)	Flash Point (Closed Cup)	Consistency	Color Dry Film	Application Method	Bonding Range	Overlap Shear Strength (PSI)		Peel Strength (PSI)	Size	UPC (021200-)	Qty./Case
							75°F (24°C)	180°F (82°C)	75°F (24°C)			
3M™ Scotch-Weld™ High Performance Plastic Adhesives												
3M™ Scotch-Weld™ Nitrile High Performance Plastic Adhesive 1099												
<ul style="list-style-type: none"> • Fast drying and heat curable • Resists weathering, water, oil, plasticizer migration, aliphatic fuels • Meets MIL-A-13883B, Type 1 and MMM-A-189C, Class 2 • A very strong plastic adhesive • Bonds most plastic and vinyl 												
 678935	32%	0°F (-18°C)	Medium Liquid	Light Tan	Brush, Flow	Up to 40 min.	1306 ^{1,2}	643 ^{1,2}	31 ³	5 oz. tube	19808-3	36
3M™ Scotch-Weld™ Nitrile High Performance Plastic Adhesive 1099L												
 679850	<ul style="list-style-type: none"> • Lower viscosity • Sprayable version of 1099 Adhesive 											
	24%	0°F (-18°C)	Thin Liquid	Tan	Spray, Brush	Up to 20 min.	1306 ^{1,2}	643 ^{1,2}	31 ³	5 gal. pail	22578-9	1
3M™ Scotch-Weld™ Nitrile High Performance Industrial Plastic Adhesive 4693H												
<ul style="list-style-type: none"> • Clear, elastomeric adhesive • Exceptional adhesion to metal and plastic • Unique in its ability to bond hard-to-hold materials like polypropylene, polyethylene and high impact polystyrene 												
 676284	36%	1°F (-17°C)	Medium Liquid	Clear	Flow, Brush	Up to 60 min.	—	—	22 ³	5 oz. tube	30088-2	36
3M™ Scotch-Weld™ High Performance Rubber and Gasket Adhesives												
3M™ Scotch-Weld™ Nitrile High Performance Rubber and Gasket Adhesive 847												
<ul style="list-style-type: none"> • Quick drying and flexible with fuel and oil resistance • Heat and solvent reactivatable • Curable with heat 												
 55587	36%	0°F (-18°C)	Medium Liquid	Brown	Flow, Brush	Up to 15 min.	200 ⁴	9 ⁴	40 ³	5 oz. tube	19718-5	36
1 Quart										19721-5	12	
3M™ Scotch-Weld™ Neoprene High Performance Rubber and Gasket Adhesive 1300												
<ul style="list-style-type: none"> • High immediate strength • Fast-drying and heat resistant for rubber and metal 												
 678931	37%	-14°F (-26°C)	Medium Liquid	Yellow	Flow, Brush	Up to 12 min.	549 ¹	136 ⁴	52 ³	5 oz. tube	19868-7	36
3M™ Scotch-Weld™ Industrial Adhesive												
3M™ Scotch-Weld™ Industrial Adhesive 4799												
<ul style="list-style-type: none"> • Brushable paste consistency with low soak-in on porous surfaces • Can bond EPDM rubber 												
 678946	36%	-14°F (-26°C)	Thin Paste	Black	Brush, Trowel	Up to 15 min.	—	—	28 ³	5 oz. tube	21354-0	36

Note: The technical information and data on these pages should be considered representative or typical only and should not be used for specification purposes.

1 Aluminum to aluminum @ 0.1 inches/minute

2 Bonds heat cured for 15 minutes @ 324°F (162°C), 150 PSI

3 Canvas to cold rolled steel @ 2.0 inches/minute separation rate

4 Birch plywood to birch plywood @ 0.1 inches/minute separation rate



3M™ Non-Structural Adhesives (cont.)

3M™ Scotch-Weld™ Neoprene Contact Adhesives

This line offers a wide range of choices for contact adhesives applications. Select from bonding ranges, strengths, solids contents and solvent formulations to meet requirements for bonding laminate, foam and more.

Product Number/ Description	Solids Weight (Approx.)	Flash Point (Closed Cup)	Consis- tency	Color Dry Film	Applic- ation Method	Bonding Range	Overlap Shear Strength (PSI)		Peel Strength (PSI)	Color	Size	UPC (021200-)	Qty./ Case		
							75°F (24°C)	180°F (82°C)	75°F (24°C)						
3M™ Scotch-Weld™ Neoprene Contact Adhesive 5															
<ul style="list-style-type: none"> • Rapid strength buildup • Heat and creep resistant bond • Bonds many high pressure plastic laminates to metal and other surfaces 	19%	-14°F (-26°C)	Thin Liquid	Green, Light Yellow	Spray	30 min. max.	482 ¹	65 ¹	19 ²	Green	5 Gal. Pail	21232-1	1		
										Light Yellow				20333-6	
3M™ Scotch-Weld™ Neoprene Contact Adhesive 10															
<ul style="list-style-type: none"> • Similar performance to Contact Adhesive 5 • Brushable with higher coverage • Bonds aluminum, steel, rubber and other porous and non-porous materials to each other or to themselves 	22%	-14°F (-26°C)	Thin Liquid	Light Yellow	Brush, Roller	30 min. max.	482 ¹	65 ¹	19 ²	Light Yellow	1 Quart	20272-8	12		
											1 Gal.			20274-2	4
											5 Gal. Pail			20276-6	1
3M™ Scotch-Weld™ Neoprene High Performance Contact Adhesive 1357															
<ul style="list-style-type: none"> • Rapid buildup to a very high strength bond for metal • Resists heat and continuous load stress • Adheres well to metal, rubber, wood and glass 	25%	-14°F (-26°C)	Thin Liquid	Gray- green, Light Yellow	Brush, Spray	30 min. max.	536 ¹	199 ¹	42 ²	Gray Green	5 oz. tube	19887-8	36		
											1 Pint			19890-8	12
											1 Quart			19892-2	
											1 Gal.			19894-6	4
														22586-4	
											5 Gal. Pail			19897-7	1
64963-9															

1 Birch plywood to birch plywood @ 0.1 inches/minute separation rate

2 Canvas to cold rolled steel @ 2.0 inches/minute separation rate

3M™ Non-Structural Adhesives (cont.)

3M™ Sealants

Help keep air, dirt, fuel, cold, heat or other elements in or out, you'll find formulations from acrylic to polyurethane.



87965

Product Number/Description	Solids Weight (Approx.)	Flash Point (Closed Cup)	Consistency	Color (Dry)	Application Method	Cure or Dry Time	Service Temperature Range	Size	UPC (02100-)	Qty./Case
3M™ Polyurethane Sealant 540										
<ul style="list-style-type: none"> • Polyurethane • One-component • Moisture cures rapidly to flexible seal/bond for many plastics, metal, wood and more • 250 psi tensile strength 	90%	136°F (58°C)	Mastic	Gray	Hand or Pressure Caulk	24 hours (3/16" dia. bead)	-40° to 194°F (-40° to 90°C)	10.5 oz. cartridge	41594-4	12
								400ml sausage pack	96277-6	
3M™ Polyurethane Adhesive Sealant 560										
<ul style="list-style-type: none"> • Similar to 540 but with 580 psi tensile strength • May replace mechanical fasteners 	90%	136°F (58°C)	Mastic	Gray	Hand or Pressure Caulk	24 hours (3/16" dia. bead)	-40° to 194°F (-40° to 90°C)	1/10 gallon cartridge	41596-8	12
3M™ Scotch-Seal™ Tamper Proof Sealant 1252										
<ul style="list-style-type: none"> • Fire retardant seal • Resists oil, gasoline, water, jet fuel and fungus • Will not corrode metal • Tack-free in 20 seconds 	70%	20°F (-7°C)	Thin Paste	White	Pressure-Flow Gun	24 hours (1/8" dia. bead)	-20° to 250°F (-29° to 121°C)	5 oz. tube	20193-6	36
3M™ Scotch-Seal™ Metal Sealant 2084										
<ul style="list-style-type: none"> • Seals metal to glass in windows and doors • Resists weather, water, oil and gasoline 	46%	0°F (-18°C)	Heavy Liquid	Aluminum	Brush or Flow	24 hours (1/8" dia. bead)	-30° to 250°F (-34° to 121°C)	5 oz. tube	20227-8	36

Note: The technical information and data on these pages should be considered representative or typical only and should not be used for specification purposes.

3M™ Structural Adhesives









679348

3M™ Scotch-Weld™ Epoxy and Acrylic Adhesives

Used as an alternative for mechanical or fusion fastening due to its greater design latitude, cleaner lines, lighter weight, greater durability, less machining and often less cost.

Product Number/Color/Description	Mix Ratio (Vol) B:A	Approx. ² Viscosity 75°F (24°C) (CPS)	Approx. ³ Worklife at 75°F (24°C)	Ave. T-Peel ⁴ at 75°F (24°C) (PIW)	Overlap Shear Strength ⁵ (PSI)			Size	UPC (021200-)	Qty./Case
					-67°F (-55°C)	75°F (24°C)	180°F (82°C)			
Epoxy										
3M™ Scotch-Weld™ Epoxy Adhesive DP100 Clear										
<ul style="list-style-type: none"> • Fast cure rigid epoxy • 15–20 minute handling strength • Transparent when cured 	1:1	13,000	4 min.	2	900	1500	300	1.7 fl. oz	22648-9	12

3M™ Structural Adhesives (cont.)

Product Number/Color ¹ / Description	Mix Ratio (Vol) B:A	Approx. ² Viscosity 75°F (24°C) (CPS)	Approx. ³ Worklife at 75°F (24°C)	Ave. T-Peel ⁴ at 75°F (24°C) (PIW)	Overlap Shear Strength ⁵ (PSI)			Size	UPC (021200-)	Qty./ Case
					-67°F (-55°C)	75°F (24°C)	180°F (82°C)			
Epoxy										
3M™ Scotch-Weld™ Epoxy Adhesive DP100 Plus										
 505232	<ul style="list-style-type: none"> Higher peel and shear strength version of 178-100 									
	1:1	8,500	4 min.	10	3000	3500	200	1.7 fl. oz.	87195-5	12
3M™ Scotch-Weld™ Epoxy Adhesive DP420 Off-White										
 679363	<ul style="list-style-type: none"> Medium worklife, toughened epoxy 1–2 hours handling strength Tough, durable structural bonds Very high performance, two-part epoxy adhesive Great for bonding metal, plastic and wood 									
	2:1	30,000	15 min.	50	4500	4500	1260	1.2 fl. oz.	82236-0	12
3M™ Scotch-Weld™ Epoxy Adhesive 2216 B/A Gray										
 667274	<ul style="list-style-type: none"> Long worklife flexible epoxy 8–12 hrs. handling strength Bonds plastic, metal and other dissimilar materials 									
	2:3	80,000	90 min.	25	2000	2500	400	Quart Kit	20356-5	6
3M™ Scotch-Weld™ Epoxy Adhesive DP460 Off-White										
 679352	<ul style="list-style-type: none"> Long worklife toughened epoxy 2–4 hours handling strength Very high performance epoxy adhesive Great for bonding a wide variety of materials with outstanding reliability and durability 									
	2:1	30,000	60 min.	60	4500	4500	700	1.25 fl. oz.	82225-4	12
Acrylic										
3M™ Scotch-Weld™ Low Odor Acrylic Adhesive DP810										
 678453	<ul style="list-style-type: none"> Acrylic bonds many metals and plastics without surface prep Fast strength buildup Fully cured in 8 hours Low odor High peel and shear strength on slightly oily steel, aluminum, glass and painted surfaces 									
	1:1	18,000 – 30,000	8–10 min.	30	1200	3600	500	1.7 fl. oz.	49077-4 (Black) 31310-3 (Tan)	12
3M™ Scotch-Weld™ Low Odor Acrylic Adhesive DP810NS Clear										
 678388	<ul style="list-style-type: none"> Non-sag version of DP810 10-15 minute handling strength 									
	1:1	90,000 – 95,000	8–10 min.	20	1200	4000	500	1.7 fl. oz.	49082-8	12
3M™ Scotch-Weld™ Structural Plastic Adhesive DP8005										
 679365	<ul style="list-style-type: none"> 2-part acrylic adhesive bonds to polyethylene and polypropylene with no surface preparation Tough bond strength to resist vibration and impact Bonds most difficult-to-bond LSE (low surface energy) plastics 									
	10:1	27,500	2.5–3 min.	16	—	2000	300	35mL	41547-0 (Translucent) 45167-6 (Black)	12

Note: The technical information and data on these pages should be considered representative or typical only and should not be used for specification purposes.

1 Color is mixed if two-part product

2 Brookfield viscometer viscosity values are typical values for the mixed product

3 The time during which an adhesive will adequately wet-out on a substrate

4 180° peel tested on .030" aluminum per ASTM D 1876-61T

5 Tested per ASTM D 1002-64

3M™ Structural Adhesives (cont.)

3M™ EPX™ Applicators & Accessories

Mixing nozzle will perform to your requirements. With consistent air pressure for easy uniform application, the Duo-Pak cartridge will give you the flow rate needed. Fast, convenient way to simultaneously meter, mix and apply two-part adhesives and potting compounds. System features handy Duo-Pak Adhesive Cartridges that snap quickly into the durable, lightweight EPX applicator. A slight squeeze on the trigger advances the plunger into the cartridge. Accurate measurement and the mixing nozzle provides thorough mixing and precise placement of material. Ideal system for assembly, maintenance and in-field service.



189875

Product Number/Description	Size	UPC (021200-)	Qty./Case
3M™ EPX™ Metal Applicator #9470 with 2:1 Plunger	50mL	21789-0	10
3M™ EPX™ 50mL Pneumatic Applicator with 2:1 Plunger	50mL	83528-5	1
3M™ EPX™ Plus II Applicator with 2:1 and 1:1 Plunger (manual)	50mL	50004-6	10
3M™ EPX™ Plus II Square Gold Mixing Nozzle	127mm	97331-4	36
3M™ EPX™ Mixing Nozzle #9742 for 50ml applicator	50mL	21791-3	72
3M™ EPX™ 2:1 Plunger Assembly for 50ml applicator	—	82314-5	10



3M™ Scotch-Weld™ Instant Adhesive

For speed and performance, you'll find a product with the right combination of bond strength, cure time and viscosity.

Product Number/ Description	Base	Time ¹ to Handling Strength (sec.)	Viscosity (CPS)	Ave. T-Peel ² at 75°F (24°C) (PIW)	Overlap Shear Strength ³ at 75°F (24°C) (PSI)						Size	UPC (021200-)	Qty./ Case
					Steel	Alumi- num	Nitrile Rubber	Neoprene Rubber	APS	Rigid PVC			
3M™ Scotch-Weld™ Instant Adhesive CA40H													
<ul style="list-style-type: none"> • Better void filling capabilities • Good adhesion to aluminum, EPDM, rubber and flexible vinyl • Good resistance to soap solutions and isopropyl alcohol 													
 322427	Ethyl	5–40	400–600	1–2	1500	1500	35*	55*	900*	1000*	1 oz.	21073-0	12

Note: The technical information and data on these pages should be considered representative or typical only and should not be used for specification purposes.

1 The time it takes assembled parts to reach a strength where further handling and processing can take place. Times will depend on surface to be bonded, temperature and humidity.

2 Tested per ASTM D1876-61T

3 Tested per ASTM D1002-64

* Substrate Failure



3M™ Scotch-Weld™ Instant Adhesives

Description	Product Number	Typical Use	Color	Typical Viscosity (cps)	Temp. Range (°F)	Time to Handling (sec.)	Full Cure (hrs.)	Bottle Size	UPC (051111-)	Qty./ Case
Instant Adhesives										
3M™ Scotch-Weld™ Metal Instant Adhesive MC100										
 <ul style="list-style-type: none"> • Optimum performance and high strength bonds on metal to metal • Bond galvanized, anodized, and other difficult-to-bond metals • Two standard viscosities • Markets/Application Ideas: Costume jewelry, treated metals, plated metals and metal working 	MC100	Low viscosity metal bonder	Clear	80–120	-65° to 180°	5–20	24	1 oz.	91663-6	10
								1 lb.	UPC (048011-) 62634-5	1

3M™ Scotch-Weld™ Anaerobic Adhesives

Description	Product Number	Typical Use	Color	Typical Viscosity (cps)	Temp. Range (°F)	Time to Handling (min.)	Full Cure (hrs.)	Bottle Size	UPC (048011-)	Qty./ Case
Threadlockers										
3M™ Scotch-Weld™ Threadlockers										
<ul style="list-style-type: none"> • Prevent vibration loosening • Seal against leakage and corrosion • Replaces wide variety of traditional and sometimes ineffective vibration proofing methods, reducing cost and increasing performance 										
	TL22	Screwlock—Low removal torque for small fasteners less than a 1/4" (6mm) (Hand tool for removal)	Purple	1,200	-65° to 300°	< 20	24	1mL	31541-1†	100
								10mL	62601-7	10
								250mL	62603-1	2
								50mL	62602-4	10
	TL42	Nutlock—Medium strength, general purpose (Hand tool for removal)	Blue	1,200	-65° to 300°	< 20	24	1mL	62604-8	10
								10mL	62605-5	10
								1L	25124-5†	1
								250mL	62607-9	2
	TL72	High temperature studlock with gap filling for larger diameter coarse threaded parts (Heat and hand tool for removal)	Red	7,000	-65° to 300°	< 20	24	10mL	62606-2	10
								1L	25133-7†	10
								250mL	25136-8†	1
	TL90	Penetrating adhesive for pre-assembled fasteners and porosity sealing of welds (Heat and hand tool for removal)	Green	20	-65° to 300°	< 20	24	250mL	25135-1†	2
50mL								25137-5†	10	
10mL								62615-4	10	
								1L	25150-4†	1
								250mL	62617-8	2
								50mL	62616-1	10

† Order using prefix 051115

Note: The technical information and data on these pages should be considered representative or typical only and should not be used for specification purposes.

3M™ Scotch-Weld™ Anaerobic Adhesives (cont.)

Description	Product Number	Typical Use	Color	Typical Viscosity (cps)	Temp. Range (°F)	Time to Handling (min.)	Full Cure (hrs.)	Bottle Size	UPC (048011-)	Qty./Case	
Retaining Compounds											
<ul style="list-style-type: none"> Used in the assembly of coaxial components such as bearings, gears, shafts bushes, pulleys, cylinder liners and rotors Increase load bearing characteristics of cylindrical joints, reducing assembly stresses, assembly costs and preventing fretting and corrosion 											
	3M™ Scotch-Weld™ General Purpose Retaining Compound RT09										
	RT09	For tight tolerances and press fit augmentation	Green	125	-65° to 300°	10–30	24	10mL	62661-1	10	
								250mL	62663-5	2	
								50mL	62662-8	10	
	3M™ Scotch-Weld™ Slip Fit/Slow Cure Retaining Compound RT35										
	RT35*	High strength for slip fits	Green	2,000	-65° to 300°	10–60	24	10mL	62667-3	10	
								250mL	62669-7	2	
								50mL	62668-0	10	
	3M™ Scotch-Weld™ Pressure Fit/Hi Temperature Retaining Compound RT40								UPC (051115-)		
	RT40*	Secures all types and sizes of bearings, shafts and cylindrical parts	Green	600	-65° to 400°	10–15	24	250mL	25735-3	2	
50mL								25734-6	10		

*Made to order.

Description	Product Number	Typical Use	Color	Typical Viscosity (cps)	Temp. Range (°F)	Cured Speed Unprimed (Primed)	Cured State	Size	UPC (048011-)	Qty./Case
Gasket Maker Adhesives										
<ul style="list-style-type: none"> Create formed-in-place gaskets on flanges and housings to eliminate need for large inventories of pre-cut gaskets Will not relax or shrink Exceptional pressure and solvent resistance 										
	3M™ Scotch-Weld™ Gasket Maker GM15									
	GM15	General purpose; flexible to withstand vibration	Purple	Paste	-65° to 300°	1–12 hrs. (15 min.–2 hrs.)	Flexible	250mL tube	62656-7	2
								300mL cart.	62657-4	10
								50mL tube	62655-0	
	3M™ Scotch-Weld™ Gasket Maker GM18									
GM18	Instant low pressure seal without a primer on mating aluminum flanges	Red	Paste	-65° to 300°	4–24 hrs. (30 min.–4 hrs.)	Flexible	300gm cart.	62660-4	10	
							50mL tube	62658-1		

Description	Product Number	Typical Use	Size	UPC (048011-)	Qty./Case
Anaerobic Primers					
3M™ Scotch-Weld™ Anaerobic Activator AC649					
	AC649	Acetone-based green primer for inactive or very cold surfaces; 30 day part life for pre-application	2 fl. oz. bottle	62708-3	10
			8 fl. oz. bottle	62709-0	4
			1 gal. can	62707-6	1

Note: The technical information and data on these pages should be considered representative or typical only and should not be used for specification purposes.

3M™ Protective Tapes

Tape Number Identification Guide

Film Thickness
(nominal thickness in mils)
Exception: 25A10 - 25 = 2.5 mils

Film Color
B — Blue
C — Clear
W — White
X — Black/White
No Letter — Clear

Film Type
1 — LDPE
4 — Polypropylene
6 — Polyester
A — Co-Extruded PE
E — Co-Extruded PE (Carpet Tape Only)
U — Translucent UV Stable Film
W — Co-Extruded PE - Black/White

Adhesive Type
Adhesives:
04, 05, 10
12, 14, 23, 42, 73
25, 26, 29, 43, 56, 58
67, 79, 82, 87, 88, 89
93EZ, 95EZ

Tack Level:
Very Low = VL
Low = L
Moderate = M
High = H
Very High = VH

3W26X

How to use this selection guide: The 3M™ Protective Tape Products Selection Guide is a quick reference of standard 3M™ Protective Tape Products to help the user select appropriate tapes for consideration and evaluation in their applications. Products are color-coded by product family for easy reference. It is essential that the user evaluate the 3M™ Protective Tape Product to determine whether it is suitable for a particular purpose to meet the user's expectation.

Many factors can affect the use and performance of a 3M™ Protective Tape Product in a particular application:

- Surface texture of substrate
- Surface preparation of substrate (including use of solvents)
- Method and conditions of tape application
- Time and environmental conditions
- Storage conditions

Ordering Information

3M™ Protective Tapes are custom ordered products. Please contact your local 3M Authorized Distributor or your 3M Sales Specialist for ordering information. For further assistance, call PolyMask Corporation at 1-800-241-2031.

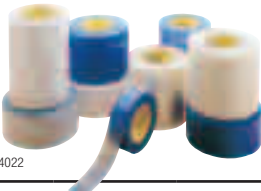
Total Tape Thickness		2.0 Mil (0.05mm)								2.5 Mil									
 <p>Product Number (Color Coded by Tape Family)</p>		2A04	2A05	2A10	2A12	2A25	2A26	2A29	2A87	2AU23B/UV	2AU26B/UV	25A10	25A12	25A25	25A26	25A29	25A87		
		Backing		Co-Ex.	Co-Ex.	Co-Ex.	Co-Ex.	Co-Ex.	Co-Ex.	Co-Ex.	Co-Ex.	Co-Ex.	Co-Ex.	Co-Ex.	Co-Ex.	Co-Ex.	Co-Ex.	Co-Ex.	
		Tack Level		VL	VL	VL	L	M	M	M	H	L	M	VL	L	M	M	M	H
Metals Uncoated	Aluminum	Mill Finished																	
		Galvanized																	
		Anodized Specular																	
		Anodized — Flat																	
Metals Uncoated	Stainless Steel	#2B Annealed																	
		#4 Mill Polished																	
		#8 Mirrored																	
		#10 Mirrored																	
Coated — Steel or Aluminum	Steel	Laser Cuttable																	
		Embossed	Flat																
			Gloss																
		Matte	Matte																
			Bronze																
			Dissimilar Metals																

3M™ VHB™ Tapes

For over 30 years, engineers have been specifying 3M™ VHB™ Tapes to permanently bond and seal many metals, plastics, and other surfaces for increased productivity, high strength, long term durability and improved appearance.

3M™ VHB™ Tape's all-acrylic construction seals against moisture and most solvents, providing long-term resistance to UV and temperature cycles. The tape's unique foam acts as a shock absorber for outstanding impact resistance. Unlike the stress points common to mechanical fasteners, 3M™ VHB™ Tapes distribute the stress. You can use thinner, light-weight materials with less material fatigue.



Product Number		Color	Temperature Resistance		
			Short	Long	
4941	(45 mils)	Gray	300°F (149°C)	200°F (93°C)	Conformable and plasticizer resistant. Good adhesion to metals, plastics and plasticized vinyls.
4611	(45 mils)	Dark Gray	450°F (232°C)	300°F (149°C)	Bonds to bare metal and holds parts together during the washes and high temperature bake of a powder paint cycle. Used for hat channel and stiffeners.
5952	(45 mils)	Dark Gray	300°F (149°C)	200°F (93°C)	Bonds to most liquid and powder painted surfaces, and ABS blends, without the need to prime the surface first.
4945	(45 mils)	White	300°F (149°C)	200°F (93°C)	Plasticizer resistant. High strength firm core. Bonds to most painted substrates. Good adhesion to substrates containing plasticizers.
4950	(45 mils)	White	300°F (149°C)	200°F (93°C)	Bonds to most metals and high surface energy substrates.

Note: The technical information and data on these pages should be considered representative or typical only and should not be used for specification purposes.

Product Number	Size	UPC (021200-)	Qty./Case
4941			
	1/2" x 36 yds.	64886-1	18
	3/4" x 36 yds.	64887-8	12
	1" x 36 yds.	64888-5	9
4611			
	1/2" x 36 yds.	56375-1	18
	3/4" x 36 yds.	56002-6	12
	1" x 36 yds.	56146-7	9
5952			
	1/2" x 36 yds.	59967-5	18
	1" x 36 yds.	56229-7	9
4945			
	1/2" x 36 yds.	16961-8	18
	3/4" x 36 yds.	16954-0	12
	1" x 36 yds.	16955-7	9
4950			
	1/2" x 36 yds.	18090-3	18
	3/4" x 36 yds.	18091-0	12
	1" x 36 yds.	18092-7	9

To evaluate how 3M™ VHB™ Tapes can be used in your applications, contact your 3M Sales Specialist or call 1-866-279-1288.



360843

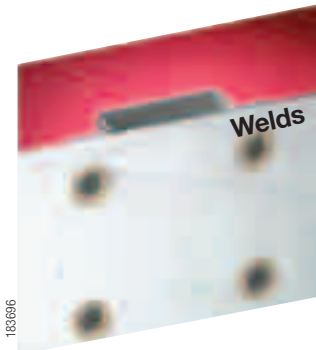

163696

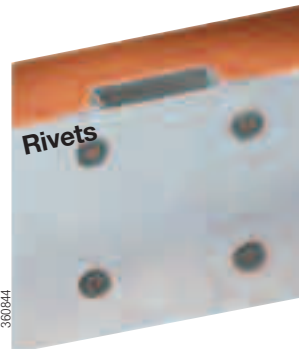

360844

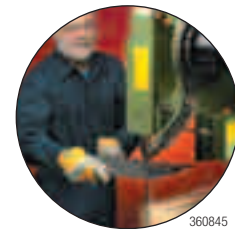

360845



199234

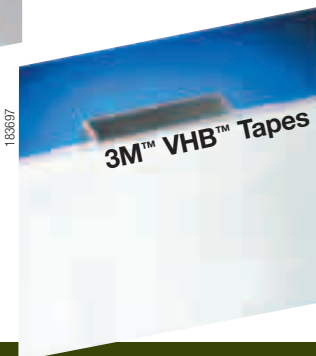

163697

3M™ Masking Products



**CLASS I
MASKING**



**CLASS II
MASKING**



**CLASS III
MASKING**

Increasing Holding Power, Line Sharpness,
and Clean Removal

Performance (30 minute bake)

Tapes with best-in-class holding power for critical paint lines and clean removal on high valued products or processes.

2693 Up to 325°F (163°C)

231 Up to 300°F (149°C)

232 Up to 250°F (121°C)

Tapes with reliable masking and clean removal on surfaces for functional coatings or paints, splicing, and heavy duty maintenance.

2380 Up to 325°F (163°C)

2364 Up to 300°F (149°C)

234 Up to 250°F (121°C)



Tapes with clean removal for light duty bundling, attaching and labeling.

2307 Up to 200°F (93°C)

200 Up to 200°F (93°C)

2214 Up to 150°F (66°C)

- What is your application?
- To what temperature will the tape be exposed during use?
- Do you need maximum holding power during use?
- Do you need maximum paint edge sharpness when the tape is removed?
- Do you want to remove the tape without slivering and adhesive residue?

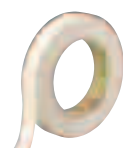
Product Number/Description	Backing/ Adhesive	Total Thickness mils (mm)	Temperature Range °F (°C)	Size	UPC (021200-)	Qty./ Case	
3M™ Masking Products — Class I Masking							
Scotch® Premium High Performance Masking Tape 2693							
 50862	<ul style="list-style-type: none"> • Designed for applications where very aggressive room temperature and high temperature holding is required • Excellent for multi-bake paint cycles 	Tan Mini-Crepe Paper/ Rubber	8.5 (0.21)	Up to 325°F (163°C)*	24mm x 55m	37629-0	36
					36mm x 55m	41121-2	24
					48mm x 55m	37630-6	
					72mm x 55m	42979-8	12
Scotch® Paint Masking Tape 231							
 86989	<ul style="list-style-type: none"> • Excellent for paint masking • Sticks at a touch and stays put • Tough and smooth high performance crepe paper tape • All-purpose masking tape 	Natural Colored Crepe Paper/ Rubber	7.6 (0.19)	Up to 300°F (149°C)*	24mm x 55m	03777-1	36
					36mm x 55m	04111-2	24
					48mm x 55m	04237-9	
					72mm x 55m	04936-1	12
Scotch® High Performance Masking Tape 232							
 13373	<ul style="list-style-type: none"> • Excellent for paint masking • Sticks at a touch and stays put • Tough and smooth high performance crepe paper tape 	Natural Colored Crepe Paper/ Rubber	6.3 (0.16)	Up to 250°F (121°C)*	24mm x 55m	02854-0	36
					36mm x 55m	02855-7	24
					48mm x 55m	04240-9	
					72mm x 55m	02858-8	12

Note: The technical information and data on these pages should be considered representative or typical only and should not be used for specification purposes.

* Up to 30 minutes

3M™ Masking Products (cont.)

Product Number/Description	Backing/ Adhesive	Total Thickness mils (mm)	Temperature Range °F (°C)	Size	UPC (021200-)	Qty./ Case	
3M™ Masking Products — Class II Masking							
Scotch® Performance Masking Tape 2380							
 50860	<ul style="list-style-type: none"> Designed for industrial paint masking applications Helps assure a good paint line whether air drying or oven baking 	Mini-Crepe Paper/ Natural Synthetic/ Rubber Blend	Up to 325°F (163°C)*	24mm x 55m	44583-5	36	
				36mm x 55m	44582-8	24	
				48mm x 55m	44581-1		
				72mm x 55m	44580-4	12	
Scotch® Performance Masking Tape 2364							
 50859	<ul style="list-style-type: none"> For general masking applications where good holding power and temperature performance is required Designed for many industrial applications Easy tearing and sliver resistance, controlled unwind, clear removal 	Tan Crepe Paper/ Natural Synthetic/ Rubber Blend	Up to 300°F (149°C)*	24mm x 55m	43352-8	36	
				36mm x 55m	43353-5	24	
				48mm x 55m	43354-2		
				72mm x 55m	43355-9	12	
Scotch® General Purpose Masking Tape 234							
 169188	<ul style="list-style-type: none"> Excellent control unwind for paint masking Resists transfer and slivering Conforms well 	Natural Colored Crepe Paper/ Rubber	Up to 250°F (121°C)*	24mm x 55m	02982-0	36	
				36mm x 55m	02983-7	24	
				48mm x 55m	04244-7		
				72mm x 55m	02985-1	12	
3M™ Masking Products — Class III Masking							
3M™ Masking Tape 2307							
 86975	<ul style="list-style-type: none"> General purpose grade Solvent-free construction; non-critical paint masking 	Natural Colored Crepe Paper/ Rubber	5.2 (0.13)	Up to 200°F (93°C)**	12mm x 55m	71116-9	72
					18mm x 55m	71117-6	48
					24mm x 55m	71118-3	36
					36mm x 55m	71119-0	24
					48mm x 55m	71120-6	
					60mm x 55m	55672-2	16
					72mm x 55m	71121-3	12
Product Number/Description							
3M™ Paper Tape 200							
 13372	<ul style="list-style-type: none"> Natural colored, 4.5 mils (0.11mm) crepe paper tape with rubber adhesive Used for holding, bundling, sealing, non-critical masking, and a vast number of other jobs where a pressure sensitive tape is needed 	Natural Colored Crepe Paper/ Rubber	4.4 (0.11)	Up to 200°F (93°C)*	12mm x 55m	53469-5	72
					18mm x 55m	53464-0	48
					24mm x 55m	53465-7	36
					36mm x 55m	53470-1	24
					48mm x 55m	53466-4	
					72mm x 55m	53467-1	12

Note: The technical information and data on these pages should be considered representative or typical only and should not be used for specification purposes.

* Up to 30 minutes

** Up to 1 hour

3M™ Masking Products (cont.)

Product Number/Description	Backing/ Adhesive	Total Thickness mils (mm)	Temperature Range °F (°C)	Size	UPC (021200-)	Qty./ Case	
3M™ Masking Products — Class III Masking							
3M™ Paper Masking Tape 2214							
 <p>148594</p>	<ul style="list-style-type: none"> Economical, quality, general purpose paper tape with rubber adhesive Use for bundling, sealing, holding and non-critical indoor jobs 5.3 mils pressure sensitive tape resists slivering 	Natural Colored Crepe Paper/Rubber	5.2 (0.13)	Up to 150°F (66°C)*	12mm x 55m	45587-2	72
					18mm x 55m	26074-2	48
					24mm x 55m	26075-9	36
					36mm x 55m	26076-6	24
					48mm x 55m	26077-3	
					72mm x 55m	26078-0	12

Note: The technical information and data on these pages should be considered representative or typical only and should not be used for specification purposes.

* Up to 30 minutes

Product Number/Description	Size	UPC (051131-)	Qty./Case
3M™ Masking Products — Painting			
3M™ Scotchblok™ Masking Paper Gold			
 <p>12026</p>	18" x 750'	06718-9	2
3M™ Masking Paper White			
 <p>12029</p>	18" x 750'	06539-0	2
3M™ Masking Products — Welding			
3M™ Welding and Spark Deflection Paper			
 <p>43640</p>	24" x 150'	05916-0	2

Note: The technical information and data on these pages should be considered representative or typical only and should not be used for specification purposes.

Scotch® High Strength Tapes— Bundling and Reinforcing Solutions

3M has developed a wide range of high strength tapes, resistant to abrasion, moisture and scuffing, for the bundling and reinforcing challenges faced in the industrial marketplace. Applications for these high performance products can vary dramatically — from tabbing the end lap of metal coils to stabilizing pallets to reinforcing large bulk containers or just a single carton.

These tapes balance tensile strength and adhesive holding power, even under extreme conditions, providing secure, cost-effective solutions for a variety of strapping, bundling and reinforcing applications.





Coil Tabbing

- 880NR
- 898NR
- 8919

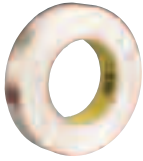
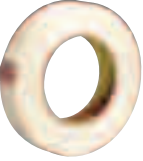

Pipe Bundling

- 880
- 894

Product Number/ Description	Backing Color	Backing	Reinforcement	Adhesive	Elongation at Break	Tensile Strength (lbs./in.)	Size	UPC (021200-)	Qty./ Case
Coil Tabbing									
Scotch® High Performance Filament Tape 880NR									
<ul style="list-style-type: none"> • Excellent balance of high initial adhesion and long-term holding power to fiberboard, metals, printed and painted surfaces including applications exposed to higher temperatures and/or lightly oiled surfaces • Applications include bundling of heavy or sharp objects such as tubing and rods and tabbing the end lap of large metal coils 									
 195276	Clear	Scotchpar™ Film	Polyester yarn	Natural rubber resin	19%	270	18mm x 55m	48445-2	48
							24mm x 55m	48446-9	36
							48mm x 55m	48448-3	24
Scotch® High Performance Filament Tape 898NR									
<ul style="list-style-type: none"> • Formulated to provide balanced performance having both high adhesion and long term holding power 									
 195278	Clear	Scotchpar™ Film	Polyester yarn	Natural rubber resin	3%	380	18mm x 55m	48450-6	48
							24mm x 55m	48451-3	36
							48mm x 55m	48453-7	24
Scotch® Filament Tape 8919									
<ul style="list-style-type: none"> • Ideal for securing hinged appliance doors or parts during shipping and the end lap of steel or aluminum coils • Specially formulated adhesive to provide clean removal and stain resistance on certain substrates 									
 195267	Clear	Scotchpar™ Film	Glass yarn	Natural rubber resin	3%	380	18mm x 55m	39875-9	48
							24mm x 55m	39876-6	36
							48mm x 55m	39878-0	24

Note: The technical information and data on these pages should be considered representative or typical only and should not be used for specification purposes.

Scotch® High Strength Tapes— Bundling and Reinforcing Solutions (cont.)

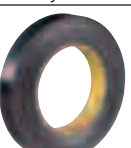
Product Number/ Description	Backing Color	Backing	Reinforcement	Adhesive	Elongation at Break	Tensile Strength (lbs./in.)	Size	UPC (021200-)	Qty./ Case
Pipe Bundling									
Scotch® Filament Tape 880									
<ul style="list-style-type: none"> • High impact and cut resistance • Long term holding power to fiberboard, non-oily metals and printed and painted surfaces 									
 <small>195275</small>	Clear	Scotchpro™ Film	Polyester yarn	Synthetic rubber resin	19%	270	12mm x 55m	39842-1	72
							18mm x 55m	39844-5	48
Scotch® Filament Tape 894									
<ul style="list-style-type: none"> • General purpose packaging tape • When used in bundling, reinforcing or coil tabbing applications with high temperatures and/or oily surfaces, tests should be conducted to determine the tape's suitability 									
 <small>195271</small>	Black	Scotchpro™ Film	Glass yarn	Synthetic rubber resin	4.5%	300	18mm x 55m	88131-2	48

Note: The technical information and data on these pages should be considered representative or typical only and should not be used for specification purposes.

Scotch® Filament Tape Dispensers

Product Number/Description	Size	UPC (021200-)	Qty./Case
Scotch® Filament Tape Dispenser H-120			
 <small>63625</small> <ul style="list-style-type: none"> • Portable dispenser with durable metal construction for carton sealing • Accommodates filament tape up to 1" (24mm) for high volume applications with fewer stops • Quickly and easily refillable 	1"	11041-2	48
Scotch® Box Sealing Tape Dispenser H-123			
 <small>63604</small> <ul style="list-style-type: none"> • Lightweight, compact, hand-held dispenser • For pressure sensitive tapes up to 72mm wide x 55m (3" wide x 60 yds.) on 3" cores • Sturdy metal construction for durable, long-life performance 	3"	11102-0	6
Scotch® Box Sealing Tape Dispenser H-128			
 <small>188797</small> <ul style="list-style-type: none"> • Durable, heavy-duty metal dispenser • Provides a quick and easy method of applying H-seal and center-seam closures of RSCs • Lightweight steel construction • Adaptable for a variety of on-the-spot applications • Accommodates tapes up to 2" (48mm) wide on a 3" core 	2"	06909-3	6
Scotch® Definite Length Dispenser M-82			
 <small>100370</small> <ul style="list-style-type: none"> • Heavy-duty dispenser • Handles multiple tape rolls simultaneously from 1/2" (12mm) to a maximum combined width of 4" (98mm) • Applications include definite tape lengths for box closure, holding, appliance and electronics reinforcing, strapping, or bundling, and lift-flap taping on Basillod containers 	4"	18959-3	1

3M™ Specialty Tapes

Whether you need an acid-resistant tape for plating masking, a tape that will come off cleanly after high temperature powder coating or a tape with thermal conductivity, you can find it in 3M™ Specialty Tape Solutions.

Product Number/Description	Color	Backing	Adhesive	Elongation at Break	Tensile Strength (lbs./in.)	Size	UPC (021200-)	Qty./Case	
3M™ Polyester Tapes 8901/8902									
<ul style="list-style-type: none"> • Use as a maskant with easy removal for powder coat painting • Polyester film that retains flexibility and thermal resistance and is abrasion, chemical and thermal resistant to help reduce failures due to cracking and backing deterioration • Silicone adhesive for higher heat resistance (up to 400°F; 204°C) than many other adhesives to help reduce failure due to softening, oozing and adhesive transfer 									
 50873	8901	Blue	Polyester	Silicone	115%	28	1" x 72 yds.	85764-5	36
							2" x 72 yds.	85765-2	24
	8902				130%	53	1" x 72 yds.	85766-9	36
							2" x 72 yds.	85767-6	24
3M™ General Purpose Polyester Tape 8951/8952									
 85697	<ul style="list-style-type: none"> • Designed to provide clean removal during hi temperature/hi pressure masking operations • Polyester film retains flexibility and thermal resistance to help reduce cracking • Abrasion, chemical and thermal resistance helps reduce backing deterioration • Hi heat resistant (up to 425°F; 218°C) silicone adhesive helps reduce failure due to softening, oozing and adhesive transfer 								
	8951	Blue	Polyester	Silicone	100%	30	1" x 72 yds.	48225-0	36
							2" x 72 yds.	48227-4	24
	8952				110%	55	1" x 72 yds.	48230-4	36
						2" x 72 yds.	48232-8	24	
3M™ Polyester Tape 8992									
 462002	<ul style="list-style-type: none"> • Silicone adhesive has high temperature properties to perform powder-coat masking, flash breaker and bag seeding applications • Polyester film is solvent, heat, abrasion and shrink resistant • Green color makes tape placement obvious for both application and removal • Thin backing leaves a sharp paint line 								
	8992	Dark Green	Polyester	Silicone	83%	48	1" x 72 yds.	25736-0*	9
						2" x 72 yds.	25759-9*	6	
3M™ Glass Cloth Tape 361									
 50863	<ul style="list-style-type: none"> • For extreme temperatures • 5.4 mil backing thickness • Can withstand intermittent temperatures up to 550°F (288°C) or higher, depending upon the type and duration of the heat source 								
	361	White	Glass Cloth	Silicone	10%	182	1" x 60 yds.	03017-8	36
						2" x 60 yds.	04275-1	24	
3M™ Electroplating Tape 470									
 51586	<ul style="list-style-type: none"> • Excellent resistance to most chemicals used in typical electroplating operations • Resists most common solvents—care should be taken to avoid ketones, chlorinated hydrocarbons and esters found in lacquer thinners, degreasers, paint strippers, etc. which may cause the backing to swell or curl • Conformable • Can be qualified to meet Federal Specification HH-T-0025 (GSA-FSS) 								
	470	Tan	Pigmented Vinyl Plastic	Rubber	180%	20	1" x 36 yds.	85616-7	36
						2" x 36 yds.	85617-4	24	
3M™ Aluminum Foil Tape 425									
 495552	<ul style="list-style-type: none"> • Good candidate as a maskant in electroplating of aluminum because it will not contaminate the bath • Adhesion to steel: 47 oz./in. width • An acrylic adhesive, combined with a durable aluminum backing, offers ideal properties for long serviceable life indoors and out • Aluminum backing provides excellent reflection of both heat and light 								
	425	Shiny Silver	Dead Soft Aluminum	Acrylic	8%	30	1" x 60 yds.	60572-7	36
						2" x 60 yds.	60574-1	24	
3M™ Lead Foil Tape 420/421									
 145295	<ul style="list-style-type: none"> • Can be die-cut into specific shapes • Very good conformability • Adhesion to steel: 45 oz./in. width • Good thermal properties and will perform over a wide variety of temperature conditions (-60° to 225°F; -54° to 106°C); use indoors or out • Electrically and thermally conductive 								
	420	Dark Silver	Lead Foil	Rubber (Green)	12%	20	1" x 36 yds.	04923-1	9
							2" x 36 yds.	03081-9	6
	421				14%	15	1" x 36 yds.	04917-0	9
						2" x 36 yds.	03195-3	6	

*Order using prefix 051115.

Scotch® Box Sealing Tapes

With Scotch Box Sealing Tapes, you have the flexibility to seal boxes in a wide range of environments for durable and secure closure in packing stations. The tape is tough enough to resist score-line breaking and center-seam splitting, even when subject to rough handling.



Features: Strong backing with either pressure-sensitive hot melt synthetic rubber resin adhesive or acrylic adhesives for reliable closures. A variety of hand-held dispensers allow for quick and easy application.

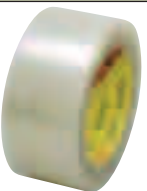
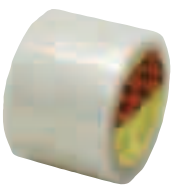
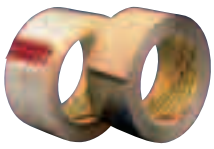

Product Number/Description	Backing/ Adhesive	Total Thickness mils (mm)	Color	Size	UPC (021200-)	Qty./ Case
Scotch® Box Sealing Tape 355						
 <p>226785</p> <ul style="list-style-type: none"> • Used for demanding packaging applications • Considered water resistant as per ASTM D5570 • Adheres instantly to most surfaces, including cartons containing high levels of recycled content • High edge tear and split resistance • Superior performance ensures reliable closures 	Polyester Film/ Hot Melt Rubber-Resin	3.43 (.09)	Clear	48mm x 50mm	72330-8	36
				48mm x 914mm	72300-1	4
				72mm x 50mm	72331-5	24
				72mm x 914mm	72333-9	2
			Tan	48mm x 50mm	06651-9*	36
				72mm x 50mm	72327-8	24
Scotch® Box Sealing Tape 375						
 <p>48050</p> <ul style="list-style-type: none"> • Excellent performance box sealing tape • Seals heavy, high-value, over-packed, or under-packed packages • Strong for demanding situations • Meets US postal regulations 	Polypropylene/ Synthetic Rubber	3.1 (.079)	Clear	48mm x 50m	72406-0	36
				48mm x 914mm	72408-4	6
				72mm x 50m	72407-7	24
				72mm x 914mm	72409-1	4
			Tan	48mm x 50m	72401-5	36
				72mm x 50m	72402-2	24
Scotch® Box Sealing Tape 373						
 <p>226794</p> <ul style="list-style-type: none"> • High performance packaging tape • Used for box sealing, splicing, recouperage and other demanding packaging applications • Heavy duty, conformable backing • Consistent pressure sensitive hot melt adhesive system • Time proven construction assures high performance in a wide range of environments and applications 	Polypropylene/ Synthetic Rubber	2.5 (.064)	Clear	48mm x 50m	72368-1	36
				48mm x 914mm	72377-3	6
				48mm x 1500mm	72379-7	3
				72mm x 50m	69605-3	24
				48mm x 100m	73079-5	36
				72mm x 100m	73080-1	24
			Tan	72mm x 914mm	72378-0	4
				48mm x 50m	72359-9	36
				72mm x 50m	72361-2	24
				48mm x 100m	73081-8	36
				72mm x 100m	73082-5	24
				Scotch® Box Sealing Tape 371		
 <p>48050</p> <ul style="list-style-type: none"> • Seals single wall corrugated cartons or bundles a group reliably • Polypropylene backing for tear resistance • Pressure-sensitive rubber adhesive offers quick, moisture proof seal • A good, tight, general purpose seal 	Polypropylene/ Synthetic Rubber	1.9 (.048)	Clear	48mm x 50m	13679-5	36
				72mm x 50m	19279-1	24
				48mm x 100m	15873-5	36
				48mm x 914mm	13681-8	6
				48mm x 1500mm	61823-9	6
				72mm x 100m	19280-7	24
				72mm x 914mm	18198-6	4
				72mm x 1500mm	62455-1	4
			Tan	48mm x 50m	14105-8	36
				72mm x 50m	18197-9	24
				48mm x 100m	15872-8	36
				48mm x 914mm	14107-2	6
				72mm x 100m	61525-2	24



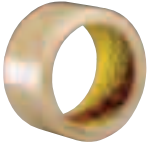

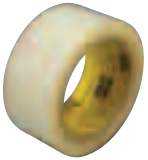
*Order using prefix 051131.

Scotch® Box Sealing Tapes (cont.)



Product Number/Description	Backing/ Adhesive	Total Thickness mils (mm)	Color	Size	UPC (021200-)	Qty./ Case
Scotch® Box Sealing Tape 311						
 195156	<ul style="list-style-type: none"> • General purpose box sealing tape designed specifically for utility type applications on light to medium weight boxes • Adheres instantly to a variety of surfaces, even in colder and damper environments • Conformable backing • Edge tear and split resistant • Good aging in sunlight or fluorescent lighting 	Polypropylene/ Pressure Sensitive Acrylic	Clear	48mm x 100mm	88292-0	36
				48mm x 1500mm	69398-4	6
				72mm x 100mm	69397-7	24
Tartan™ General Purpose Box Sealing Tape 305						
 195155	<ul style="list-style-type: none"> • General purpose packaging tape used for non-critical box sealing applications • A conformable backing • Good closure for lightweight boxes exposed to minimal distribution hazards 	Polypropylene/ Pressure Sensitive Acrylic	Clear	48mm x 100mm	39809-4	36
				48mm x 914mm	39810-0	6
Scotch® Cold Temperature Box Sealing Tape 3331						
 649689	<ul style="list-style-type: none"> • Ideal for applications at refrigeration temperatures or at room temperature with subsequent storage at low temperatures • Adheres to a wide variety of surfaces between 30°–40°F (-1°–4°C), secured closures maintained below 32°F (0°C) • Excellent tack at low temperatures 	Polypropylene/ Pressure Sensitive Hot Melt Rubber Resin	Clear	48mm x 100mm	32173-3	36
				48mm x 914mm	32174-0	6
				72mm x 100mm	32175-7	24
				72mm x 914mm	32176-4	4

3M™ Box Sealing Tape Dispensers



Scotch® and Tartan™ brand hand-held dispensers are designed for use with specially formulated 3M box sealing tapes for improved ease of use.

Product Number/Description	Size	UPC (021200-)	Qty./Case
Scotch® Box Sealing Tape Dispenser H122			
 196837	48mm (2")	06925-3	6
Scotch® Low Noise Tape Dispenser H150			
 196835	48mm (2")	39518-5	6
Scotch® Low Noise Tape Dispenser H153			
 195182	72mm (3")	39820-9	6
Scotch® Box Sealing Tape Dispenser H180			
 195186	48mm (2")	19008-7	6

3M™ Box Sealing Tape Dispensers (cont.)

Product Number/Description		Size	UPC (021200-)	Qty./Case
Scotch® Box Sealing Tape Dispenser H183				
 195177	<ul style="list-style-type: none"> Recommended for center seam sealing of RSC boxes Metal and high-impact plastic construction for durability and long-life performance Hand-held dispenser features adjustable tape break 	72mm (3")	61850-5	5
Scotch® Box Sealing Tape Dispenser H192				
 196838	<ul style="list-style-type: none"> Tape tension can be controlled with tape roll break High impact plastic construction 	48mm (2")	86512-1	6
Tartan™ Box Sealing Hand Dispenser HB933				
 196847	<ul style="list-style-type: none"> Seals cartons easily and secures a smooth, one-handed roll-on motion Unique spring-loaded bar maintains constant tension during tape application For tape rolls up to 3" wide on a 3" core 	72mm (3")	22922-0	6

3M™ Duct Tapes

Product Number/Description	Backing/Adhesive	Total Thickness mils (mm)	Temperature Range °F (°C)	Color	Size	UPC (021200-)*	Qty./Case	
Class I — Clean Removal Duct Tape								
3M™ Performance Plus Duct Tape 8979								
 352555	<ul style="list-style-type: none"> Removes cleanly from most opaque surfaces, leaving behind no sticky residue for up to six months Indoors or outdoors, this tape stays on the job without deteriorating for up to twelve months Water resistant and sunlight/UV resistant 	Polyethylene film over cloth scrim/ Natural and Synthetic Rubber	12.6 (0.33)	Up to 200°F (93°C)	Slate Blue	24mm x 54.8m	048011-53922-5	48
						48mm x 54.8m	56468-0	24
						72mm x 54.8m	56469-7	12
						96mm x 54.8m	56470-3	
Class II — Heavy Duty Duct Tape								
3M™ Multi-Purpose Duct Tape 3900								
 150221	<ul style="list-style-type: none"> Polyethylene coated cloth with rubber adhesive General purpose duct tape Good choice for general maintenance, wrapping, sealing and protecting 	Polycoated Cloth/ Rubber	7.7 (.020)	Up to 200°F (93°C)	Silver	48mm x 54.8m	051131-06976-3	24
					Black		49833-6	
					Yellow		49828-2	
Class III — Utility Duct Tape								
3M™ Vinyl Duct Tape 3903								
 69452	<ul style="list-style-type: none"> Embossed vinyl film coated with rubber adhesive Designed for general sealing, color coding, masking, wrapping and bundling, protecting and other light duty applications where easy unwind, easy tear and less adhesive transfer are important 	Embossed Vinyl/ Rubber	6.3 (0.16)	Up to 250°F (121°C)	Gray	2" x 50 yds.	UPC (051131-)*	24
					Black		06984-8	
					Yellow		06995-4	
							06982-4	

*Use this prefix unless otherwise noted.

Note: The technical information and data on these pages should be considered representative or typical only and should not be used for specification purposes.



3M™ Particulate Respirators

IMPORTANT: Before use of these respiratory protection products, a written respiratory protection program must be implemented, meeting all the requirements of OSHA 29 CFR 1910.134 such as training, fit testing, medical evaluation and applicable OSHA substance specific standards.

PLEASE NOTE: All products contain Advanced Electret Media, noseclip and two straps.

Particulate Respirator	3M™ Particulate Respirator	Suggested Application	Nose Foam	3M™ Cool Flow™ Valve	Braided Comfort Strap	Carbon Media	Nose-clip	Welding Web	Adj. Straps	Individual Additional Features	UPC (051131-)	Qty./Case	
Dusty Conditions													
	8200, N95	Grinding, Sanding, Sweeping, Other dusty operations	●				S			Patented Filter Media	91913-1	160	
	8210, N95	Grinding, Bagging, Sanding, Sweeping, Other dusty operations	●				S				UPC (051138-)	46457-3	160
	8210 Plus, N95		●		●		S				52924-8		
	8271, P95	Grinding, Machining, Sanding, Sweeping, Other dusty/hot/oily operations		●	●		M			Patented Filter Media, Faceseal	54285-1	80	
	8511, N95	Grinding, Bagging, Sanding, Sweeping, Other hot/dusty operations		●	●		M			Patented Filter Media, Soft Inner Materials	54343-8	80	
	9105, N95	Grinding, Bagging, Sanding, Sweeping, Sawing, Other hot/dusty operations					A			Flat fold design, two sizes available, v-shaped pleats flex with mouth movement	UPC (051131-)	17397-7	400
	9105S, N95						A				17394-6		
	9210, N95	Grinding, Bagging, Sanding, Sweeping, Other hot/dusty operations	●				S			Patented Filter Media, Individual Packaging, Collapse Resistant	37021-5	240	
	9211, N95		●	●			S				37022-2	120	
Welding and Metal Pouring													
	8212, N95	Welding, Torch cutting, Brazing, Soldering, Metal pouring		●	●		S	●	●	Patented Filter Media, Faceseal, Cake Resistant Media	UPC (051138-)	54141-0	80
	8214, N95		Welding, Torch cutting, Brazing, Soldering, Metal pouring, Stainless, Galvanized		●	●	OV* OZ**	S	●		●	66192-7	
	8512, N95	Welding, Soldering and other applications where metal fumes are present including ozone** and nuisance level organic vapors*	●	●	●	●	S	●	●		66298-6		
	8514, N95		●	●	●	●	S	●	●		66299-3		



* OV: 3M recommended for relief against nuisance levels of organic vapors. Nuisance level refers to concentrations not exceeding the OSHA PEL or applicable government exposure limits, whichever is lower.

** OZ: 3M recommended for ozone protection up to 10 times the OSHA PEL or applicable government occupational exposure limits, whichever is lower. Not NIOSH approved for use against ozone.

S = Standard noseclip M = M-noseclip A = Adjustable noseclip

See Warning on Page 122

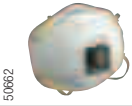
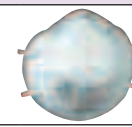
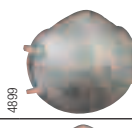
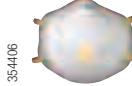
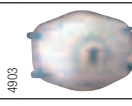







3M™ Particulate Respirators (cont.)

Particulate Respirator	3M™ Particulate Respirator	Suggested Application	Nose Foam	3M™ Cool Flow™ Valve	Braided Comfort Strap	Carbon Media	Nose-clip	Welding Web	Individual Additional Features	UPC (051131-)	Qty./Case
Welding and Metal Pouring (continued)											
	8515, N95	Welding, Torch cutting, Brazing, Soldering		●	●		M	●	Patented Filter Media	07189-1	80
Nuisance Level Odor											
	8246, R95	Aluminum, Smelting, Paper processing, Brewing operations, Glass etching, Chemical processing	●		●	AG [†]	S			54357-5	120
	8247, R95	Foundry operations, Undercoating, Lab settings, Agriculture, Petrochemical processing	●		●	OV*	S			54358-2	
	8516, N95	Aluminum, Smelting, Paper processing, Brewing operations, Glass etching, Chemical processing		●	●	AG [†]	M		Softer Inner Materials	66392-1	80
	8576, P95				●	●	AG [†]	M		54370-4	
	8577, P95	Foundry operations, Undercoating, Lab settings, Agriculture, Petrochemical processing		●	●	OV*	M			54371-1	

* OV: 3M recommended for relief against nuisance levels of organic vapors. Nuisance level refers to concentrations not exceeding the OSHA PEL or applicable government exposure limits, whichever is lower.

** OZ: 3M recommended for ozone protection up to 10 times the OSHA PEL or applicable government occupational exposure limit

Technologies

	Cool Flow™ Exhalation Valve. Proprietary one-way valve for easy exhalation and cool, dry comfort.		Advanced Electret Media. Electrostatically charged microfibers help make breathing easier and cooler.		Adjustable Buckle Straps. A single tug helps provide a comfortable, secure fit.
	M-noseclip. Adjusts easily for fewer pressure points and greater comfort.		Carbon Filter Material. Carbon layers remove many nuisance level odors* for greater wearer comfort.		P-series Filter. Featuring Advanced Electret Media, appropriate for prolonged use in oil and non-oil containing environments.
	Faceseal. Soft and secure, conforms closely to face for long-lasting comfort.		Cake-resistant Filter Media. Specially designed filter layers for welding provide longer respirator life and easier breathing.		Compatibility. Accommodates a wide range of safety equipment, including eye and hearing protection.

* Nuisance level odors refers to concentrations not exceeding the OSHA PEL or other applicable government exposure limits, whichever is lower.

See Warning on Page 122

3M™ Full and Half Facepiece Reusable Respirators

Respirator and filters provide an easy-to-use, comfortable, wide range of respiratory protection.

Applications: Use in a variety of applications including painting, welding, metalworking and auto manufacturing (when used with appropriate cartridges, filters or supplied air).

1. Choose Facepiece

Half Facepiece

5000 Series

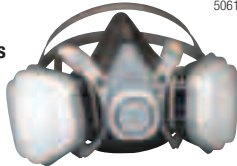

Features and Benefits

- Single use respirator: cartridges are permanently attached
- Made from soft, lightweight thermoplastic elastomer
- No ongoing maintenance necessary
- Resealable storage bag helps keep respirator clean between uses
- Low profile design provides wider field of vision and greater comfort while wearing goggles or glasses
- For convenience and simplicity, some respirator assemblies come with 3M™ Filters P95 along with 3M™ Filter Retainers 501

6000 Series



Features and Benefits

- Made from soft, lightweight thermoplastic elastomer
- Easy to adjust head straps
- Supplied with reclosable storage bag
- Swept back design improves balance and visibility
- NIOSH approved for negative pressure air purifying and positive pressure dual airline applications
- Can be used with 3M™ Filters and Cartridges or 3M™ Dual Airline System
- Available with a standard or drop-down head harness option. Drop-down model allows wearers to lower the respirator without removing hard hat or faceshield.

7500 Series



Features and Benefits

- Made from soft, resilient silicone and heat resistant plastics
- Unique head harness design gives to the user the option of wearing the respirator in traditional or drop-down mode
- 3M™ Cool Flow™ Exhalation Valve makes breathing easier, and helps reduce heat and moisture buildup in the facepiece and provides cool, dry comfort



Full Facepiece

6000 Series



Features and Benefits

- Soft, silicone face seal
- Four strap suspension for easy donning and doffing
- Bayonet attachment
- Swept back cartridge design
- Wide field of vision
- Meets all the requirements of ANSI Z87.1-2003 for high impact (Z87+)
- Integrated optical correction limits distortion as you look from the left to the right
- Directs exhaled breath and moisture downward
- Smooth surface allows for quick and easy cleaning
- Available with negative pressure and dual airline models

7800S Series



Features and Benefits

- Double-flange face seal and six adjustable straps help provide a secure fit
- Made of silicone for increased comfort and durability
- Extra-large inhalation and exhalation valves help make breathing easier
- Use with 3M™ Filters and Cartridges and/or a variety of powered and supplied air systems

FF-400 Series



Features and Benefits

- Large lens featuring Scotchgard™ Protector
- Passive speaking diaphragm
- 3M™ Cool Flow™ Valve makes breathing easier, helps reduce heat and moisture buildup in the facepiece, and provides cool, dry comfort
- Durable, long-lasting head harness and comfort cradle
- Soft, silicone nose cup and face seal

Product	Model	Size	UPC (051138-)	Qty./Case
3M™ Half Facepiece Respirator				
5000 Series	51P71	S	66068-5	12
	52P71	M	66069-2	
	53P71	L	66070-8	
Product	Model	Size	UPC (051131-)	Qty./Case
6000 Series	6100	S	07024-5	24
	6200	M	07025-2	
	6300	L	07026-9	
7500 Series	7501	S	37081-9	10
	7502	M	37082-6	
	7503	L	37083-3	

Product	Model	Size	UPC (051131-)	Qty./Case
3M™ Full Facepiece Respirator				
6000 Series	6700	S	54145-8	4
	6800	M	54146-5	
	6900	L	54159-5	
Product	Model	Size	UPC (051138-)	Qty./Case
7800S Series	7800S-S	S	54257-3	1
	7800S-M	M	54258-0	
	7800S-L	L	54259-7	
Product	Model	Size	UPC (051135-)	Qty./Case
FF-400 Series	FF-401	S	89418-2	4
	FF-402	M	89421-2	
	FF-403	L	89424-3	

Note: When used in supplier air mode, employer must provide a minimum of Grade D breathing air in accordance with OSHA requirements.

See Warning on Page 122

3M™ Particulate Filters and Gas/Vapor Cartridges

These filters and cartridges can be used interchangeably with 3M™ Reusable Respirators 6000, 7000 and FF-400 Series.



2. Choose Filter/Cartridge Combination

Particles

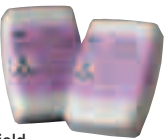
3M™ Particulate Filters 2000 Series	Product Number/Description	UPC	Qty./Case
 <ul style="list-style-type: none"> Lightweight and easy to breathe through Assortment of filters available for a wide range of applications Easier breathing through new 3-layer advanced Electret Filter Media in 2200 Series Filters 	2071 Particulate Filter, P95	051138- 54356-8	50
	2076HF Particulate Filter, Hydrogen Fluoride/P95, with Nuisance Level Acid Gas Relief*	051138- 54369-8	
	2078 Particulate Filter, P95 with Nuisance Level Organic Vapor/Acid Gas Relief*	051138- 54368-1	
	2091 Particulate Filter, P100	051131- 07000-9	
	2096 Particulate Filter, P100, with Nuisance Level Acid Gas Relief*	051138- 54295-5	
	2097 Particulate Filter, P100, with Nuisance Level Organic Vapor Relief*	051131- 07184-6	
	2291 Advanced Particulate Filter, P100	051131- 17170-6	
	2296 Advanced Particulate Filter, P100, with Nuisance Level Acid Gas Relief*	051131- 17171-3	
	2297 Advanced Particulate Filter, P100, with Nuisance Level Organic Vapor Relief*	051131- 17172-0	



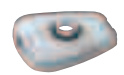
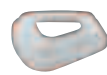





3M™ Particulate Filter 7093, P100	Product Number/Description	UPC	Qty./Case
<ul style="list-style-type: none"> Unique, spring-loaded filter cover design simplifies negative pressure user seal checks Swept-back design provides enhanced field of view and greater comfort 7093C offers a lightweight, low profile design that combines P100 filtration with carbon-loaded features found in heavier combination cartridge products 	7093 Particulate Filter, P100	051131- 52705-3	60
	7093B Particulate Filter, P100, Bulk	051131- 52706-0	144
	7093C Cartridge/Filter, Hydrogen Fluoride, P100, with Nuisance Level Organic Vapor/Acid Gas Relief*	051131- 37173-1	60

Filter Retainer and Filter Adapters for Particles



Adapter 502***	Retainer 501	Adapter 603
		
100/Case	100/Case	16/Case
051138- 21511-3	051138- 17668-1	051138- 54376-6

***Do not reuse.

Gases and Vapors



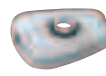



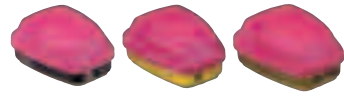

3M™ Gas/Vapor Cartridges 6000 Series	Product Number/Description	UPC	Qty./Case
 <ul style="list-style-type: none"> Low-profile design helps maintain good field of vision Full range of cartridges to meet your needs 	6001  Cartridge, Organic Vapor	051138- 21674-5	30 pairs
	6002  Cartridge, Acid Gas**	051138- 28880-3	
	6003  Cartridge, Organic Vapor/Acid Gas**	051138- 07047-4	
	6004  Cartridge, Ammonia/Methylamine	051138- 28882-7	
	6005  Cartridge, Formaldehyde/Organic Vapor	051138- 28883-4	
	6006  Cartridge, Multi Gas/Vapor**	051138- 54186-1	
	6009  Cartridge, Mercury Vapor or Chlorine	051138- 29148-3	

Filter Retainer and Filter Adapter for Gases and Vapors

Adapter 502***	Retainer 501
	
100/Case	100/Case
051138- 21511-3	051138- 17668-1

***Do not reuse.

Particles and Vapors

3M™ Combination Cartridges/ P100 Particulate Filters 6000 Series	Product Number/Description	UPC	Qty./Case
 <ul style="list-style-type: none"> Particulate filter is permanently attached to cartridge for easy, one-step assembly Unique design for enhanced comfort and visibility 	60921  Cartridge/Filter, Organic Vapor/P100	051138- 46465-8	30 pairs
	60922  Cartridge/Filter, Acid Gas/P100**	051138- 46466-5	
	60923  Cartridge/Filter, Organic Vapor/Acid Gas/P100**	051138- 46467-2	
	60924  Cartridge/Filter, Ammonia/Methylamine/P100	051138- 46468-9	
	60925  Cartridge/Filter, Formaldehyde/Organic Vapor/P100	051138- 46469-6	
	60926  Cartridge/Filter, Multi-Gas/Vapor/P100**	051138- 54187-8	
	60928  Cartridge/Filter, Organic Vapor/Acid Gas/P100***	051138- 46470-2	
	60929  Cartridge/Filter, Mercury Vapor/Chlorine Gas/P100	051138- 46471-9	

* 3M recommended for relief against nuisance levels of organic vapors and acid gases. Nuisance level organic vapor and acid gas refers to concentrations not exceeding OSHA PEL or applicable government occupational exposure limits, whichever is lower. Do not use for respiratory protection against acid gases or organic vapors (except hydrogen fluoride).

** Reminder: These cartridges are approved for respiratory protection from hydrogen sulfide gas up to 10 times the permissible exposure limit (PEL) with half facepiece respirators and full facepiece respirators when qualitatively fit tested, or up to less than 300 parts per million (ppm) with full facepiece respirators when quantitatively fit tested or according to specific OSHA standards or applicable government regulations, whichever is lower. 300 ppm is the concentration considered Immediately Dangerous to Life or Health (IDLH) for hydrogen sulfide.

† As recommended by the California Department of Pesticide Regulation No. 01-009-Methyl Bromide Field Fumigation. 3M recommended for use against radioiodine and methylbromide. Note: not NIOSH approved for methylbromide or radioiodine.

See Warning on Page 122

3M™ Speedglas™ Welding Helmets

3M™ Speedglas™ 100 Welding Helmets

- Auto-Darkening Filters (ADF) 100V, 100S-10 and 100S-11 are good for Stick, MIG and most TIG welding and offer excellent optical quality
- ADF 100V has dark shades 8–12 (shade 3 in the light state) and three user-selectable sensitivity levels for reliable arc detection
- ADFs 100S-10 and 100S-11 have shades 3 and 10 or 11 respectively
- Viewing area: 6.05 in²



Description	Product Number	Shade	UPC	Qty./Case
Black Welding Helmets				
100 Series Welding Helmet with ADF 100V	07-0012-31BL	3, 8–12	051131- 49529-6	1
100 Series Welding Helmet with ADF 100S-10	07-0012-10BL	3, 10	051131- 37230-6	
100 Series Welding Helmet with ADF 100S-11	07-0012-11BL	3, 11	051131- 37231-3	
Graphic Welding Helmets				
Blazed 100 Series Welding Helmet with ADF 100V	07-0012-31BZ	3, 8–12	051131- 37233-7	1
Aces High 100 Series Welding Helmet with ADF 100V	07-0012-31AH		051131- 37237-5	
American Pride 100 Series Welding Helmet with ADF 100V	07-0012-31AP		051131- 37238-2	
Women's Welding Helmets 				
Steel Eyes 100 Series Welding Helmet with ADF 100V	07-0012-31SE	3, 8–12	051131- 37226-9	1
Skull Jewels 100 Series Welding Helmet with ADF 100V	07-0012-31SJ		051131- 37227-6	
Steel Rose 100 Series Welding Helmet with ADF 100V	07-0012-31SR		051131- 37228-3	
Wild-N-Pink 100 Series Welding Helmet with ADF 100V	07-0012-31WP		051131- 37229-0	

3M™ Speedglas™ 9100 Welding Helmets

- Radically-new design fundamentally changes not only how the user wears the helmet, but also how the welder experiences the helmet's fit, stability and balance
- ADFs 9100V, 9100X and 9100XX have dark shades 5, 8–13 (shade 3 in the light state), sensitivity adjustment that allows use with all Stick, MIG and TIG processes, as well as grinding and torch cutting modes
- Viewing areas: 9100V = 6.05 in²; 9100X = 9.12 in²; 9100XX = 12.11 in²



Description	Product Number	Shade	UPC	Qty./Case
9100 Series Welding Helmet with ADF 9100V	06-0100-10	3, 5, 8–13	051135- 89353-1	1
9100 Series Welding Helmet with Side Windows and ADF 9100V	06-0100-10SW		051135- 89354-8	
9100 Series Welding Helmet with ADF 9100X	06-0100-20		051131- 37172-9	
9100 Series Welding Helmet with Side Windows and ADF 9100X	06-0100-20SW		051135- 89356-2	
9100 Series Welding Helmet with ADF 9100XX	06-0100-30		051131- 37191-0	
9100 Series Welding Helmet with Side Windows and ADF 9100XX	06-0100-30SW		051135- 89387-6	

See Warning on Page 122

3M™ Speedglas™ Welding Helmets (cont.)

NEW! 3M™ Speedglas™ 9100 FX
Welding Helmets

- Innovative wide-view grinding visor to give welders an all-in-one solution for more flexibility, precision, and efficiency
- Exceptionally clear, wide grinding visor offers a greater field of view in all directions, while a smooth flip-up pivot mechanism assures effortless transition from welding to grinding modes
- ADFs 9100V, 9100X and 9100XX have dark shades 5, 8–13 (shade 3 in the light state), sensitivity adjustment that allows use with all Stick, MIG and TIG processes, as well as grinding and torch cutting modes
- Viewing areas: 9100V = 6.05 in²; 9100X = 9.12 in²; 9100XX = 12.11 in²



Description	Product Number	Shade	UPC	Qty./Case
9100 FX Series Welding Helmet with Side Windows and ADF 9100V	06-0600-10SW	3, 5, 8–13	051131- 49671-2	1
9100 FX Series Welding Helmet with Side Windows and ADF 9100X	06-0600-20SW		051131- 49673-6	
9100 FX Series Welding Helmet with Side Windows and ADF 9100XX	06-0600-30SW		051131- 49675-0	

3M™ Speedglas™ SL (Super Light) Welding Helmet

- Only 12.6 oz. (including filter)
- ADF has variable shades 8–12 and 4 sensitivity levels
- Head suspension increases adjustability



Description	Product Number	Shade	UPC	Qty./Case
SL Welding Helmet with ADF	05-0013-41	3, 8–12	051131- 98564-3	1

3M™ Speedglas™ Auto-Darkening Filters (ADF)









	Speedglas 100	Super Light (SL)	Speedglas 9100
Viewing Area	1.73" x 3.66" (44mm x 93mm)	1.68" x 3.57" (91mm x 43mm)	9100V: 1.8" x 3.7" (44mm x 93mm) 9100X: 2.1" x 4.2" (54mm x 107mm) 9100XX: 2.8" x 4.2" (73mm x 107mm)
Dark State Options	Shades 8–12 (variable) Shade 10 or Shade 11 (single shade)	Shades 8–12 (variable)	Shades 5, 8–13 (variable)
Weight — Complete Assembly (Ounces)	15 (Black Helmet) 16 (Graphic Helmet)	13	9100V: 18.0 (18.9 w/SideWindows) 9100X: 18.3 (19.2 w/SideWindows) 9100XX: 19.2 (20.1 w/SideWindows)
Special Modes	None	Automatic on/off	Grinding, Tacking*, Lock-in Dark State
Switching Speed (Milliseconds)	0.1	< 0.15	0.1
Battery Life (Hours)	1,500	1,500	9100V: 2,800 9100X: 2,500 9100XX: 2,000
Sensitivity Modes	3 levels	4 levels	5 levels

*Patented feature — ONLY available on 3M™ Speedglas™ 9100 Series Welding Helmets.

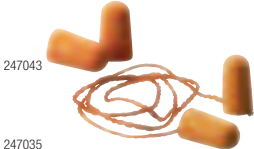
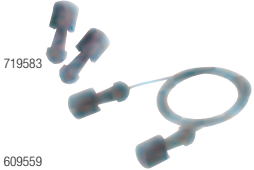
See Warning on Page 122

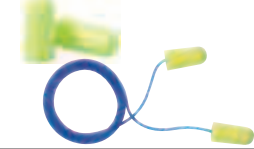
Hearing Conservation





3M offers a wide variety of solutions to help reduce noise exposure. A full line of comfortable, easy-to-use hearing protectors, including earplugs, ear muffs, and banded hearing protectors are available from 3M.

Product Number/Description		Model	UPC (051138-)	Qty./Case
3M™ Foam Earplug 1100 and 3M™ Corded Foam Earplug 1110				
 <p>247043 247035</p>	<ul style="list-style-type: none"> • Smooth dirt resistant surface and tapered shape fit the ear canal and provide added comfort and hygiene • Hypo-allergenic material • Each package is easy to dispense • Noise Reduction Rating: 29 dB* • Available in corded and uncorded versions 	1100 (uncorded)	29008-0	1000 Pairs
		1110 (corded)	29009-7	500 Pairs
3M™ Pistonz™ Earplugs P1400 and 3M™ Pistonz™ Corded Earplugs P1401				
 <p>719583 609559</p>	<ul style="list-style-type: none"> • Instant-use — No need to roll down • Stem is stiff enough for insertion, yet designed to flex sideways if impacted • Metallic-style earplug tips with ultra-soft feel for all day wear • Officially licensed hearing protection of NASCAR® • Noise Reduction Rating: 29 dB* • Available in corded and uncorded versions 	P1400 (uncorded)	93401-7	400 Pairs
		P1401 (corded)	93402-4	400 Pairs
3M™ E-A-R™ Classic™ Uncorded Earplugs 310-1001				
 <p>706318</p>	<ul style="list-style-type: none"> • Conforms to the shape of the ear canal to help create a comfortable, snug noise barrier • Pillow pak keeps these disposable earplugs available, reusable and clean • Slow-recovery earplug foam is non-flammable and moisture resistant • Meets ANSI S3.19-1974; CSA Class AL • Noise Reduction Rating: 29 dB* 	310-1001	10000-6	2000 Pairs
3M™ E-A-Rsoft™ Yellow Neons™				
	<ul style="list-style-type: none"> • Noise Reduction Rating: 33 dB* (Highest NRR available) • Soft foam provides low pressure with excellent attenuation 	312-1250 (uncorded)	12063-9	2000 Pairs
		311-1250 (corded)	11033-3	
3M™ E-A-R™ UltraFit™				
	<ul style="list-style-type: none"> • Noise Reduction Rating: 25 dB* • Flanged design for comfortable fit • Conforms to shape of ear • Washable, promotes worker hygiene • No rolling or touching plug portion during insertion 	340-4003 (uncorded)	40002-1	400 Pairs
		340-4004 (corded)	40003-8	
		340-4002 (corded w/case)	40001-4	200 Pairs
3M™ E-A-R™ Push-Ins™ with Grip Rings				
	<ul style="list-style-type: none"> • Shaped for comfort and gripped for fit • Noise Reduction Rating: 30 dB* • Easy fit with no roll down required • Foam softens with body heat • Grip Ring design to gently hug ear canal 	318-1008 (uncorded)	18010-7	2000 Pairs
		318-1009 (corded)	18011-4	
3M™ E-A-R™ Push-Ins™				
	<ul style="list-style-type: none"> • Easy fit with no roll down required • Noise Reduction Rating: 28 dB* • E-A-Rform™ yellow foam tip for great comfort • Blue stem allows for hygienic insertion and removal 	318-1000 (uncorded)	18017-9	400 Pairs
		318-1001 (corded)	18017-9	

* Research suggests that many users will receive less noise reduction than indicated by the NRR due to variation in earplug fit and wearing time. It is recommended that the NRR be reduced by 50% for estimating the average amount of noise reduction provided.

See Warning on Page 122

Hearing Conservation (cont.)

Product Number/Description	Model	UPC (80529-)	Qty./Case
Semi-Insert Hearing Protectors			
3M™ E-A-Rflex™ Banded Hearing Protector			
 <ul style="list-style-type: none"> Noise Reduction Rating: 25 dB* Highest NRR for a semi-insert in all three positions Comfortable, lightweight alternative to earmuffs Band helps prevent loss and is good for intermittent use 	350-1001 (band w/tips)	50007-3	10/Box
	350-1002 (replacement tips)	50008-0	5 Pair/Pack
3M™ E-A-R™ One Touch™ Base and “No Waste Funnel” with Classic™ and Yellow Neon™ Plugs Banded Hearing Protector			
 <ul style="list-style-type: none"> “No Waste Funnel” allows users to reuse base and dispenser One Touch™ base can be used as a table top unit or wall mounted Easy access for the user from all sides No waste of packaging for individual earplugs 	391-1000 (dispenser)	91000-1	1/Box
	391-1001 (Classic™ replacement bottle)	91001-8	2000 Pairs
	391-1004 (Yellow Neon™ replacement bottle)	91004-9	
Product Number/Description			
3M™ Peltor™ Optime™ 95 Banded Hearing Protector			
 <ul style="list-style-type: none"> Ideal against high-frequency noise with work areas including machine shops and power tools Ultra light with liquid/foam filled ear cushions Low profile earmuff and neckband NRR 21 dB* 	H6A/V (Headband style)	08061-5	10/Case
	H6B/V (Neckband style)	08062-2	
	H6P3E/V (Helmet-attachment style)	08065-3	
3M™ Peltor™ Optime™ 101 Banded Hearing Protector			
 <ul style="list-style-type: none"> Excellent attenuation at low and high frequencies Enables safe working environment for longer periods of time, up to 101dBA Two low mounting points provide great comfort H7A: NRR 27 dB* H7B: NRR 26 dB* H7P3E: NRR 24 dB* 	H7A (Headband style)	08071-4	10/Case
	H7B (Neckband style)	08072-1	
	H7P3E (Helmet-attachment style)	08073-8	

* Research suggests that many users will receive less noise reduction than indicated by the NRR due to variation in earplug fit and wearing time. It is recommended that the NRR be reduced by 50% for estimating the average amount of noise reduction provided.

3M™ Noise Indicator NI-100

Product Number/Description	Model	UPC (051131-)	Qty./Case
 <ul style="list-style-type: none"> LED light clearly indicates when noise levels exceed a potentially hazardous threshold Helps identify areas where hearing protection may need to be worn Clip to a shirt or jacket 	NI-100	17453-5	10
	<ul style="list-style-type: none"> Charging cord Sold separately 	NI-CHG	

See Warning on Page 122



Protective Eyewear

3M eye protection products help provide wearer comfort, safety and a fashionable look. They are available in several designs to meet the needs of a wide variety of people and conditions.

Product Number/Description	Model	Color	UPC (78371-)	Qty./Case
3M™ Virtua™ AP Protective Eyewear NEW! <small>to Catalog</small>				
 <ul style="list-style-type: none"> • Popular unisex styling • Lightweight frame—less than 1 oz. • Meets ANSI Z87.1-2010 High Impact Requirements standards • Contoured flexible temples for comfortable fit • High-wrap lenses fit snug against the face, for wider viewing area. 	11815-00000-20	Gray Hard Coat Lens	11815-7	10/Box
	11816-00000-20	Light Blue Hard Coat Lens	11816-4	
	11817-00000-20	Amber Hard Coat Lens	11817-1	
	11818-00000-20	Clear Anti-Fog Lens	11818-8	
	11819-00000-20	Clear Hard Coat Lens	11819-5	
	11847-00000-20	Indoor/Outdoor Mirror Hard Coat Lens	11847-8	
665088				
3M™ Light Vision™ 2				
 <ul style="list-style-type: none"> • Ultra-bright, adjustable LED lights • Long-lasting batteries provide up to 50 hours of continuous use • Soft nose bridge and temple tips • Available in readers with three bifocal magnification strengths: +1.50, +2.00, +2.50 • Polycarbonate lenses absorb 99.9% UV • Meets the requirements of CSA Z94.3-2007 and the High Impact Requirements of ANSI Z87.1-2003 	11476-00000-10	Gray Frame/ Clear Anti-Fog Lens	62111-4	10/Case
532063				
3M™ Lexa™ Protective Eyewear				
 <ul style="list-style-type: none"> • Extra wide viewing range and contoured design • Lightweight, full coverage eye protection • Fully customizable with multiple lens options, three lens angles and four temple lengths • Meets ANSI Z87.1-2003 and CSA Z94.3-2007 	15200-00000-20	Clear Anti-Fog Lens/ Black Temple	62287-6	20/Case
	15250-00000-20	MinimlzeR™ Lens/ Black Temple	62299-9	
 <ul style="list-style-type: none"> • Designed for workers who have difficulty reading small print or who are engaged in small detail work (13415: +1.5 Diopter; 13416: +2.0 Diopter; 13417: +2.5 Diopter) • Lightweight, full coverage design • Multiple lens options, angles and temple lengths • Meets ANSI Z87.1-2003 and CSA Z94.3-2007 	13415-00000-20	MinimlzeR™ Lens/ Black Temple	13415-7	
	13416-00000-20	MinimlzeR™ Lens/ Black Temple	13416-4	
	13417-00000-20	MinimlzeR™ Lens/ Black Temple	13417-1	
576927				
3M™ BX™ Dual Protective Eyewear NEW!				
 <ul style="list-style-type: none"> • Sleek, contoured and fully adjustable with molded-in magnifying diopters on the upper and lower lenses (11457: +1.5 Diopter; 11458: +2.0 Diopter; 11459: +2.5 Diopter) • Polycarbonate lenses absorb 99.9% UV • Meets the requirements of CSA Z94.3-2007 and the High Impact Requirements of ANSI Z87.1-2003 	11457-00000-20	Silver/Black Frame/ Clear Anti-Fog Lens	11457-9	20/Case
	11458-00000-20	Silver/Black Frame/ Clear Anti-Fog Lens	11458-6	
	11459-00000-20	Silver/Black Frame/ Clear Anti-Fog Lens	11459-3	
576927				



See Warning on Page 122



3M™ Sorbents

3M™ Maintenance Sorbents: Fast acting, highly absorbent, easy to use and absorb almost any type of non-aggressive liquids such as oils, coolants, hydraulic fluids and water. Its high fluid capacity means the need to change the sorbent is less frequent, saving on material, labor and disposal costs.

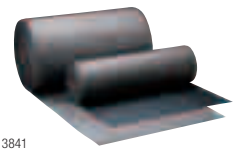
3M™ Petroleum Sorbents: Sorbs oil and other petroleum-based liquids while repelling water. Available in a variety of configurations to best suit your needs including: folded, pads, booms, pillows, sweeps, rolls and drum covers.

Product Number/Description	Model	Size	UPC (051138-)	Qty./Case
3M™ Maintenance Sorbents				
Folded M-FL550DD, High Capacity				
 <p>3835</p> <ul style="list-style-type: none"> • Easy-to-use solution for cleaning up spills, drips and fluid leaks • Versatile: can be used in pillow, pad, roll or boom configuration • Scrim on one side to increase strength and help eliminate linting • Dispenses from a carrying/dispenser box in the form of a continuous roll • Less waste: perforated every 16 inches so you can select the length required • Absorbs 31.5 gallons per case • Applications range from maintenance to spill response 	M-FL550DD	5" x 50'	29071-9	3
Rug M-RG36300E				
 <p>3841</p> <ul style="list-style-type: none"> • Use in areas where foot and vehicle traffic is a concern • Will sorb non aggressive liquids while enduring the punishment of being tread upon • Durable and versatile • Use in industrial maintenance applications • Absorbs 32 gallons per rug 	M-RG36300E	36" x 300'	29002-3	1
Mini-Boom				
 <p>3840</p> <ul style="list-style-type: none"> • Tube-like shape is ideal for placing around machinery to contain spills and prevent leaks from spreading into adjacent work areas • 3 inch diameter scrim on the outside of the boom identifies the use while containing particulate sorbent material designed for the application • Absorbs 12 gallons per case 	M-MB304	3" x 4'	21526-7	12
	M-MB308	3" x 8'	21527-4	6
3M™ Petroleum Sorbents				
Pad HP-156, High Capacity				
 <p>6756</p> <ul style="list-style-type: none"> • Low-profile design can be easily placed in tight areas • Ideal for cleaning up small spills and wiping down contaminated areas • Has a scrim on one side to increase strength and help eliminate linting • Conveniently sized, allows the user to quickly spread sorbent over and in the path of a spill • Can also be used on a work surface in anticipation of a spill or as a wipe • Absorbs 37.5 gallons per bale 	HP-156	17" x 19"	28911-4	100
Product Number/Description				
Pad T-151				
 <p>6714</p> <ul style="list-style-type: none"> • This highly sorbent pad features a low-profile design for easy placement in tight areas • Ideal for cleaning up small spills and wiping down contaminated areas • Absorbs 43.5 gallons per bale 	T-151	17" x 19"	16049-3	200

See Warning on Page 122

3M™ Fall Protection

The Height of Confidence — It is our mission at 3M to provide those responsible for the safety of workers at height with reliable fall arrest equipment. We offer the knowledge and support to help take the fear out of height.

Harnesses

3M™ Elavation™ Harness

- The premium 3M™ Fall Arrest Harness
- Premium padding
- Intuitive adjustment hardware
- Web designed for additional abrasion resistance
- Rubber protective shield for label pack



3M™ Ameba Harness

- Features comfort forming webbing
- Non-elastic helical yarn moves with wearers to assist comfort and mobility
- Value padding for added comfort and moisture wicking
- Laminated sleeve helps protect label



3M™ SafeLight™ Harness

- The economical choice in fall arrest harnesses
- Quality construction at a value price
- Bright color web assists worker visibility on a jobsite



Model	UPC (78371-)	Qty./Case
7512E	64010-8	1

Model	UPC (78371-)	Qty./Case
1451Q	63599-9	1

Model	UPC (78371-)	Qty./Case
10950	00081-0	1

Lanyards

3M™ SafeAbsorb™ Dual Leg Elast Combo Lanyard

- Stretches from 4–6 feet to help reduce trip hazards
- 310 lbs. rated
- 3,600 lbs. gate rated hardware
- Integrated shock absorber



3M™ Adjustable Lanyard w/Rebar Hooks

- Versatile offering of lengths and hardware for general use
- 310 lbs. rated
- 3,600 lbs. gate rated hardware
- Meets requirements of latest ANSI Z359.13-2009 standards
- Includes an external shock pack



3M™ SafeLight™ Lanyard

- The economical choice in fall arrest lanyards
- 310 lbs. rated
- 3,600 lbs. gate rated hardware
- Meets requirements of ANSI Z359.1-2007 standards
- Available in low-profile or external shock pack designs



Model	UPC (78371-)	Qty./Case
4750/0241	01437-4	1

Model	UPC (78371-)	Qty./Case
3251D-0241	00254-8	1

Model	UPC (78371-)	Qty./Case
209512	00103-9	1

Self-Retracting Lanyards

3M™ ReLoad™ Retractable Lifeline

- Can be inspected and serviced onsite by authorized technicians for lower maintenance costs
- Clicking sound provides audible indication that pawls are functioning correctly
- 400 lbs. max capacity for cable units; 310 lbs. for web units
- Cable units range from 23–50 feet, available in galvanized or stainless steel
- Web units range from 7–23 feet



3M™ Thor™ Galvanized Cable Lifeline

- Durable aluminum housing
- Spring cushion cable guide helps reduce cable rewind damage
- Swivel top housing for enhanced mobility
- 310 lbs. max capacity
- Cable units range from 10–30 feet, available in galvanized or stainless steel
- Web units range from 7–50 feet



3M™ Retractable Lifeline (G-Series)

- Versatile product suitable for multiple industries
- Assembled in the U.S.A. from high quality materials
- Rugged durability and lightweight design
- 310 lbs. max capacity
- Cable units range from 20–50 feet, available in galvanized or stainless steel
- Web units range from 7–20 feet



Model	UPC (78371-)	Qty./Case
REC-23	01132-8	1

Model	UPC (78371-)	Qty./Case
M-30	00359-0	1

Model	UPC (78371-)	Qty./Case
GW-11	64164-8	1

See Warning on Page 122



3M™ Fall Protection (cont.)

Anchorage Devices

3M™ SafeClaw Reusable Concrete Anchor

- Trigger mechanism allows unit to be easily inserted and removed from pre-drilled poured concrete
- Available in 5000 lbs. (Model 4075) and 10,000 lbs. (Model 4077) rated designs



Model	UPC (78371-)	Qty./Case
4075	01071-0	1
4077	01162-5	

3M™ Reusable Roof Anchor

- Hinged anchor for wood and metal decking
- Steel design
- Fits most pitch angles
- Appropriate for Horizontal Lifeline Applications



Model	UPC (78371-)	Qty./Case
4000	00050-6	1

3M™ Beamwalk III

- Lightweight aluminum construction
- Dual axis swivel D-ring helps prevent entanglement
- Smooth sliding, non-chattering mobility across exposed I and H beams

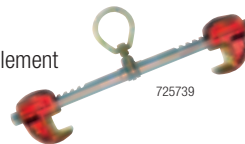

Model	UPC (78371-)	Qty./Case
4650-3	62716-1	1

3M™ Industrial Anchor

- Permanent D-bolt anchor
- Includes nut, bolt and washer hardware



Model	UPC (78371-)	Qty./Case
4005	00053-7	1

Kits

3M™ General Fall Protection Kit

- Designed for use with rental lifts
- Includes 3M™ SafeLight™ Harness (10910), 6-ft 3M™ SafeLight™ Lanyard (209512) and tool bag for equipment storage
- Can be personalized with a customer logo



Model	UPC (78371-)	Qty./Case
30500	00088-9	1

3M™ Roofing Kit

- A complete Personal Fall Arrest System in a bucket
- Includes 3M™ SafeLight™ Harness (10910), 6-ft 3M™ SafeLight™ Lanyard (209512), 3M™ Reusable Roof Anchor (4000), 50-ft Lifeline with attached Rope Grab (0221-50RG) and 5-gallon storage bucket



Model	UPC (78371-)	Qty./Case
20058	00086-5	1

See Warning on Page 122

Safety Warnings



⚠ WARNING: RESPIRATORS

These respirators help protect against certain airborne contaminants. Before use, the wearer must read and understand the *User Instructions* provided as a part of the product packaging. A written respiratory protection program must be implemented meeting all the requirements of OSHA 29 CFR 1910.134 including training, fit testing and medical evaluation. In Canada, CSA standards Z94.4 requirements must be met and/or requirements of the applicable jurisdiction, as appropriate. **Misuse may result in sickness or death.** For proper use, see package instructions, supervisor, or call 3M Occupational Health and Safety Division (OH&ESD) Technical Service in U.S.A. at 1-800-243-4630. In Canada, call 1-800-267-4414.

⚠ WARNING: WELDING PRODUCTS

These welding safety products must be used only by qualified persons trained in their use and maintenance and only in strict accordance with and adherence to the detailed instructions and precautionary statements provided in the instruction manual which accompanies each product. **Failure to comply with these instructions could result in sickness, serious bodily injury or death.** For proper use of these products read *User Instructions* and WARNINGS on the package. Any questions concerning proper use should be directed to your supervisor, on-site training specialist, industrial hygienist or 3M Occupational Health and Safety Division (OH&ESD) Technical Service in the U.S.A. at 1-800-243-4630. In Canada, call 1-800-267-4414.

⚠ WARNING: HEARING PROTECTION

These hearing protectors help reduce exposure to hazardous noise and other loud sounds. **Misuse or failure to wear hearing protectors at all times that you are exposed to noise may result in hearing loss or injury.** For proper use, see supervisor, *User Instructions*, or call 3M Occupational Health and Environmental Safety Division (OH&ESD) Technical Service in the U.S.A. at 1-800-243-4630. In Canada, call 1-800-267-4414. If there is any drainage from your ear or you have an ear infection, consult with your physician before wearing ear plugs. Failure to do so may result in hearing loss or injury.

⚠ WARNING: PROTECTIVE EYEWEAR

These eye and face protection products help provide limited eye and face protection. **Misuse or failure to follow warnings and instructions may result in serious potential injury, including blindness or death.** For proper use, selection, and applications against flying particles, optical radiation and/or splash see supervisor, read *User Instructions* and WARNINGS on the package, or call 3M Occupational Health and Environmental Safety Division (OH&ESD) Technical Service in the U.S.A. at 1-800-243-4630. In Canada, call 1-800-267-4414.

⚠ WARNING: SORBENTS

Failure to properly handle and dispose of sorbents contaminated by hazardous materials can result in serious physical injury or death and/or environmental harm. For proper handling, consult the Material Safety Data Sheet for the material absorbed, applicable safety and health standards, contact your supervisor, or call 3M Occupational Health and Environmental Safety Division (OH&ESD) Technical Service at 1-800-243-4630. To reduce the risk of serious physical injury or death, always use respiratory protection and protective clothing appropriate for handling the material to be absorbed. Transportation and disposal of spent sorbents must comply with all applicable federal, state and local laws and regulations. Caution: Sorbents may become slippery when used on flooring. Do not walk on sorbent or place in high traffic areas.



⚠ WARNING: FALL PROTECTION

Compliant fall protection and emergency rescue systems help prevent serious injury during fall arrest. Users must read and understand the *User Instructions* provided with the product and be properly trained by their employer prior to use per OSHA 1910.66 and 1926.503 or applicable local standards. **Misuse or failure to follow warnings and instructions may result in serious personal injury or death.** For proper use, see supervisor, *User Instructions*, or call 3M Occupational Health and Environmental Safety Division (OH&ESD) Technical Service in the U.S.A. at 1-800-243-4630. In Canada, call 1-800-267-4414.

3M™ Maintenance Aerosols

3M™ Maintenance Aerosols: 3M's line of aerosol cleaners are the fast and easy solution for removing grease, grime, inks, and residues on electrical equipment and components.



Product Number/Description	Size	UPC (021200-)	Qty./Case
3M™ 5-Way Penetrant			
 <ul style="list-style-type: none"> • Inhibits rust and corrosion by spreading a thin, even film that actually penetrates the pores of the surface • It displaces moisture and "dries out" electrical parts and equipment to help prevent shorting and increase conductivity • Spray it on to free rusted, frozen bolts, nuts, and screws • Lubricate delicate machines and precision instruments • Penetrates and demulsifies • Ideal as a tapping lubricant for stainless steel and aluminum • Contains no methylene chloride, 1, 1, 1-trichloroethane or chlorofluorocarbons <p>243698</p>	24 fl. oz.	21305-2	12
3M™ Citrus Base Cleaner			
 <ul style="list-style-type: none"> • Multi-purpose cleaner • Will dissolve and flush away dirt, grease, tar, most noncuring type adhesive films and similar substances • Citrus oil-based cleaner that emulsifies when flushed with water • Contains no petroleum distillates • Use to clean and degrease metal parts, motors, tools, printing presses and concrete • Contains no methylene chloride, 1, 1, 1-trichlorofluorocarbons <p>243700</p>	24 fl. oz.	76394-6	12
Product Number/Description	Size	UPC (048011-)	Qty./Case
3M™ Stainless Steel Cleaner and Polish			
 <ul style="list-style-type: none"> • Cleans and polishes stainless steel, chrome aluminum and laminated plastic surfaces • High gloss in one step • Contains no ozone depleting chemical <p>76621</p>	21 fl. oz.	14002-0	12

3M™ Electrical Products

Product Number/Description	Size	UPC (054007-)	Qty./Case
Scotch® Vinyl Electrical Tape Super 33+			
 <ul style="list-style-type: none"> • Provides primary electrical insulation for splices up to 600V • Abrasion corrosion and UV-resistant • Makes an excellent protective jacketing for high-voltage cables and wire harnessing • UL listed and CSA certified • Resists alkalis and acids, flame retardant • Excellent all-weather performance in cold to 0°F (-18°C) or hot to 220°F (105°C) <p>442178</p>	3/4" x 66'	06132-8	100



479683

3M™ Facility Care Products

3M™ Safety-Walk™ Matting

Spring-coiled vinyl foam compresses uniformly and continually, providing greater comfort and less fatigue.

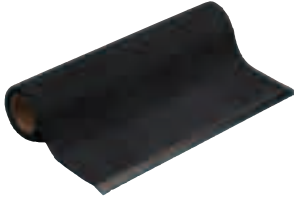
Product Number/Description	Color	Size	UPC (048011-)	Qty./Case
3270 (No Edging)				
 <ul style="list-style-type: none"> Economical matting ideal for fatigue resistance in dry environments Textured, solid surface improves traction and allows debris and liquid to stay on top of the mat for easy cleanup Lightweight for easy moving and repositioning No edging <p>31783</p>	Black	3' x 10'	34821-6	1
		3' x 20'	34823-0	
3270E (Black Edging)				
 <ul style="list-style-type: none"> Economical matting ideal for fatigue resistance in dry environments Textured, solid surface improves traction and allows debris and liquid to stay on top of the mat for easy cleanup Lightweight for easy moving and repositioning Integral edging on the long edge of the mat and nosing on the ends <p>31783</p>	Black with Black Edging	3' x 5'	34826-1	1
		3' x 10'	34828-5	
		3' x 20'	34830-8	
		4' x 6'	NEW! 34827-8 <small>To Catalog</small>	
		4' x 10'	NEW! 34829-2 <small>To Catalog</small>	

Utility Cloth Rolls

3M™ Portable Utility Roll 314D

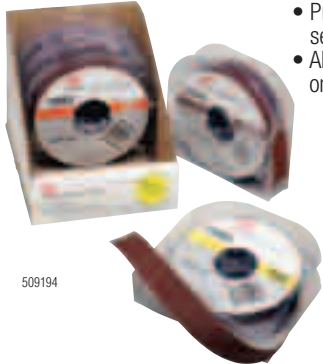
Product Number/Description	W x L	Grade	UPC (051141-)	Qty./Case
Utility Rolls				
 <ul style="list-style-type: none"> Portable for ease of use at jobsite Protective plastic pack resists dirt, oil, water and serves as a convenient dispenser Aluminum oxide abrasive product sheets constructed on X- or J-weight, durable cloth backing <p>509194</p>	1" x 8 yds.	P60 X	20963-0	1/5
	1" x 12 yds.	P60 J	20964-7	
	1" x 16 yds.	P120 J	20965-4	
	1" x 20 yds.	P180 J	20966-1	
		P240 J	20967-8	
1" Portable Utility Roll Kit				
Kit contains one (1) each of the above utility rolls			20968-0	1/5

3M™ Purification Series NB Liquid Bag Filters

3M™ Purification Series NB liquid bag filter products combine filtration experience and manufacturing expertise to provide high quality, cost effective solutions for those applications where a rated bag filtration is appropriate.



Series NB bag products are available in polypropylene felt and polyester felt in Size #1 and Size #2 configurations in grades ranging from 1–200 microns. The bags feature an all welded construction with a plastic sealing collar for consistent and reproducible filtration.



Series NB bag products are also available in nylon monofilament materials of construction in Size #1 and Size #2 configurations in grades ranging from 25–1200 microns. The high strength and uniform porosity of the NMO bags make them an excellent choice for applications looking for removal of oversized contaminants while allowing for passage of desired fluid particles (metallic paints...).

Size	Micron	UPC	Product ID	Bags Per Case
Polypropylene Felt				
#1	1	016145-18093-4	NB0001PPS1C	50
	5	016145-18099-6	NB0005PPS1C	
	10	016145-18105-4	NB0010PPS1C	
	25	016145-18111-5	NB0025PPS1C	
	50	016145-18117-7	NB0050PPS1C	
	100	016145-18123-8	NB0100PPS1C	
	200	016145-18129-0	NB0200PPS1C	
#2	1	016145-18094-1	NB0001PPS2C	
	5	016145-18100-9	NB0005PPS2C	
	10	016145-18106-1	NB0010PPS2C	
	25	016145-18112-2	NB0025PPS2C	
	50	016145-18118-4	NB0050PPS2C	
	100	016145-18124-5	NB0100PPS2C	
200	016145-18130-6	NB0200PPS2C		
Polyester Felt				
#1	1	016145-18089-7	NB0001EES1C	50
	5	016145-18095-8	NB0005EES1C	
	10	016145-18101-6	NB0010EES1C	
	25	016145-18107-8	NB0025EES1C	
	50	016145-18113-9	NB0050EES1C	
	100	016145-18119-1	NB0100EES1C	
	200	016145-18125-2	NB0200EES1C	
#2	1	016145-18090-3	NB0001EES2C	
	5	016145-18096-5	NB0005EES2C	
	10	016145-18102-3	NB0010EES2C	
	25	016145-18108-5	NB0025EES2C	
	50	016145-18114-6	NB0050EES2C	
	100	016145-18120-7	NB0100EES2C	
200	016145-18126-9	NB0200EES2C		

Size	Micron	UPC	Product ID	Bags Per Case	
Nylon Monofilament					
#1	25	016145-18195-5	NB0025NYS1R	50	
	50	016145-18197-9	NB0050NYS1R		
	100	016145-18199-3	NB0100NYS1R		
	150	016145-18201-3	NB0150NYS1R		
	200	016145-18203-7	NB0200NYS1R		
	#1	250	016145-18205-1	NB0250NYS1R	25
		400	016145-18207-5	NB0400NYS1R	
		600	016145-18209-9	NB0005PPS2C	
		800	016145-18211-2	NB0800NYS1R	
		1200	016145-18213-6	NB1200NYS1R	
#2	25	016145-18196-2	NB0025NYS2R	50	
	50	016145-18198-6	NB0050NYS2R		
	100	016145-18200-6	NB0100NYS2R		
	150	016145-18202-0	NB0150NYS2R		
	200	016145-18204-4	NB0200NYS2R		
	#2	250	016145-18206-8	NB0250NYS2R	25
		400	016145-18208-2	NB0400NYS2R	
		600	016145-18210-5	NB0600NYS2R	
		800	016145-18212-9	NB0800NYS2R	
		1200	016145-18214-3	NB1200NYS2R	

3M™ Purification Series NB Liquid Bag Filter Specifications and Operating Parameters

	Size #1	Size #2
Dimensions	7" OD x 16" L	7" OD x 32" L
Max. Operating Temperature	180°F/82°C (polypropylene felt) 300°F/149°C (polyester felt, NMO)	
Max. Recommended Flow	90 gpm	180 gpm
Recommended Changeout Differential Pressure	20 psid	



THREE EASY WAYS TO CONTACT US FOR ALL 3M INDUSTRIAL PRODUCTS:

3M can provide additional products and accessories to meet your needs. Please contact us in any of the following ways that you prefer:

- 1 Contact your local 3M authorized distributor directly. For information on a 3M distributor or sales representative in your area, contact us at the numbers below:

For the contiguous 48 United States:

Call 1-866-279-1288

Fax 1-877-369-2923



- 2 E-mail us at 3MIndustrial@mmm.com
- 3 For additional 3M product information call 1-800-3M Helps or visit us at www.3M.com

Prices subject to change without notice.

Important Notice to Purchaser

Safety Information: Always read and follow all safety information included with the product. Do not exceed maximum operating RPM's. Use guards provided with machine. Follow safety operation procedures posted in work areas.

Product Use: All statements, technical information and recommendations contained in this document are based upon tests or experience that 3M believes are reliable. However, many factors beyond 3M's control can effect the use and performance of a 3M product in a particular application, including the conditions under which the product is used and the time and environments conditions in which the product is expected to perform. Since these factors are uniquely within the user's knowledge and control, it is essential that the user evaluate the 3M product to determine whether it is fit for a particular purpose and suitable for the user's method of application.

Warranty and Limited Remedy: Unless stated otherwise in 3M's product literature, packaging inserts or product packaging for individual products, 3M warrants that each 3M product meets the applicable specifications at the time 3M ships the product. Individual products may have additional or different warranties as stated on product literature, package inserts or product packages. 3M MAKES NO OTHER WARRANTIES, EXPRESS OR IMPLIED, INCLUDING, BUT NOT LIMITED TO, ANY IMPLIED WARRANTY OF MERCHANTABILITY OR FITNESS FOR A PARTICULAR PURPOSE OR ANY IMPLIED WARRANTY ARISING OUT OF A COURSE OF DEALING, CUSTOM OR USAGE OF TRADE. User is responsible for determining whether the 3M product is fit for a particular purpose and suitable for user's application. If the 3M product is defective within the warranty period, your exclusive remedy and 3M's and seller's sole obligation will be at 3M's option, to replace the product or refund the purchase price.

Limitation of Liability: Except where prohibited by law, 3M and seller will not be liable for any loss or damage arising from the 3M product, whether direct, indirect, special, incidental, or consequential, regardless of the legal theory asserted, including warranty, contract, negligence, or strict liability.



Abrasive Systems Division
3M Center, Building 223-6S-03
St. Paul, MN 55144-1000
1-866-279-1235
www.3M.com/abrasives

Please Recycle. Printed in U.S.A.
© 3M 2011. All rights reserved.
61-5002-8097-1

3M, BX, Cool Flow, Classic, Cubitron, E-A-R, E-A-Rsoft, EARflex, Elavation, EPX, Green Corps, Hookit, Lexa, Light Vision, Neons, One Touch, Optime, Peltor, Pistonz, Push-Ins, ReLoad, Roloc, SafeAbsorb, SafeLight, Safety-Walk, Scotch, Scotch-Brite, Scotch-Seal, Scotch-Weld, Scotchblok, Scotchpar, Scotchpro, Speedglas, Stikit, Super 77, Tartan, Thor, Trizact, UltraFit, VHB, Virtua, Wetordry and Yellow Neon are all trademarks of 3M.