

*Interface Modules provide a cost effective and simple transition from cable assemblies to discrete wiring*

Interface modules are DIN-Rail mounted, PCB-based interconnect devices that provide an expedient and simplistic means to transition between system Input/Output (I/O) connectors and field equipment. Modules incorporate terminal blocks and other high-density electronic connectors.

Molex's Interface Modules have pre-drilled component holes, allowing for the addition of other electronic components, if necessary. Typical additions and modifications to the standard modules may include resistors, capacitors, diodes or light emitting diodes (LEDs) for increased functionality.

Custom interface modules are also available and allow the user to develop a connector interface system to meet virtually any application and product requirement. Molex works seamlessly with our customers to develop application specific modules to meet unique design requirements.

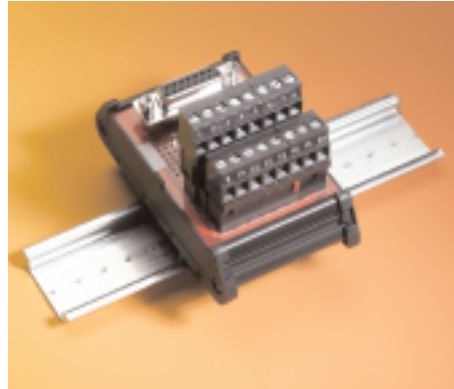

D-Sub module

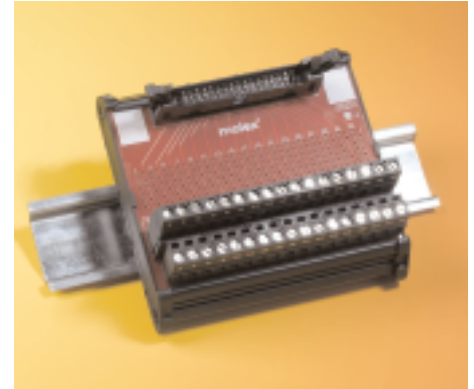

Ribbon-Cable module

**Features and Benefits**

- High-reliability rising cage clamp connection technology (on terminal blocks) provides reliable connection without strand damage
- High-packing density of compact modules enables space savings where real estate is limited
- Blocks are clearly marked to reduce wiring errors and installation time
- Fixed or pluggable terminal blocks available for discrete wire connections providing design flexibility
- Pre-drilled component holes allow for the easy addition of other components
- Pluggable terminal blocks are provided with coding pins (keys) to prevent mis-mating

**SPECIFICATIONS**

**Reference Information**

Packaging: Box  
Designed In: Inches

**Electrical**

**Terminal Blocks**

Voltage: 300V  
Current: 15.0A max.  
Dielectric Withstanding Voltage: 4000V DC  
Insulation Resistance: 5000 Megohms min.

**Ribbon Cable Connector**

Voltage: 120V  
Current: 1.0A  
Dielectric Withstanding Voltage: 1000V RMS  
Insulation Resistance: 1000 Megohms min.

**D-Sub Connector**

Voltage: 125V  
Current: 2.50A  
Dielectric Withstanding Voltage: 500V RMS  
Insulation Resistance: 1000 Megohms min.

**Physical**

**Terminal Blocks**

Housing: PA Polyamide (Nylon 6/6)  
Contact: Phosphor Bronze (CuSn)  
Plating: Contact Area — Tin (Sn)  
Operating Temperature: +110°C max.  
Flammability: UL 94V-0  
Tightening Torque-Recommended: 0.56Nm (5 in. lbs)

**APPLICATIONS**

- Machine Builders
  - Semiconductor equipment
  - Mill machines
  - Compressor systems
- Process Control Equipment/Systems
  - Instrumentation
  - Distributed Control Systems (DCS)
  - Power generation equipment
- Industrial Control Equipment
  - PLCs
  - Micro-controllers
  - Motion controllers
- Material Handling Equipment
  - Conveyor systems
  - Elevators/people movers
  - Automated warehouse controls
- Transportation
  - Signal control
  - Railway switching
  - Jetway systems
- Construction Equipment
  - Scissor lifts
  - Beam lifts

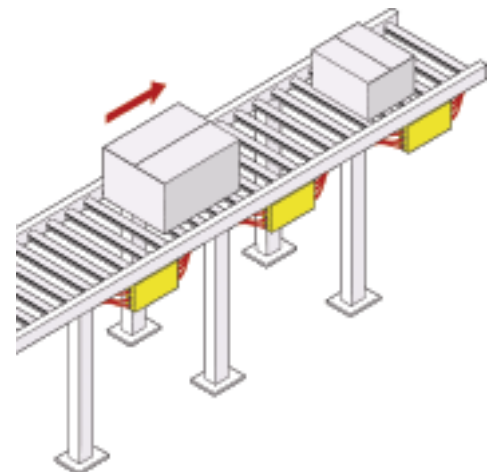

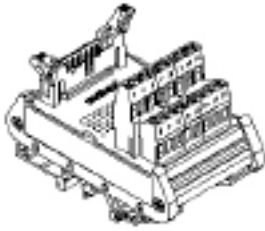

Ribbon-Cable Connector to Fixed 5.08mm (.200") Terminal Block

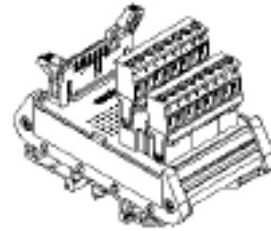

Ribbon-Cable Connector to Pluggable 5.08mm (.200") Terminal Block

Circuits	Order No.		Dimensions
	Ribbon-Cable Connector to Fixed Mount 5.08mm (.200") Terminal Block	Ribbon-Cable Connector to Pluggable 5.08mm (.200") Terminal Block	Length
14	39170-1014	39170-1114	50.80mm (2.000")
16	39170-1016	39170-1116	53.30mm (2.100")
20	39170-1020	39170-1120	61.00mm (2.400")
26	39170-1026	39170-1126	76.20mm (3.000")
34	39170-1034	39170-1134	95.00mm (3.740")
40	39170-1040	39170-1140	111.50mm (4.390")
50	39170-1050	39170-1150	135.60mm (5.340")

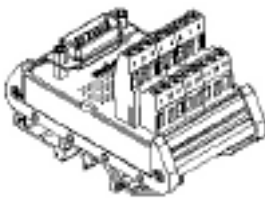

Male D-Sub Connector to Fixed 5.08mm (.200") Terminal Block



Male D-Sub Connector to Pluggable 5.08mm (.200") Terminal Block

Circuits	Order No.		Dimensions
	Male-D Sub Connector to Fixed Mount 5.08mm (.200") Terminal Block	Male-D Sub Connector to Pluggable 5.08mm (.200") Terminal Block	Length
9	39170-2009	39170-2109	39.40mm (1.550")
15	39170-2015	39170-2115	54.40mm (2.140")
25	39170-2025	39170-2125	79.80mm (3.140")
37	39170-2037	39170-2137	106.40mm (4.190")
50	39170-2050	39170-2150	142.00mm (5.590")

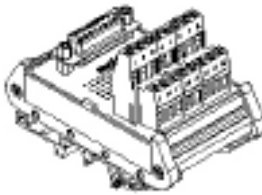

Female D-Sub Connector to Fixed 5.08mm (.200") Terminal Block

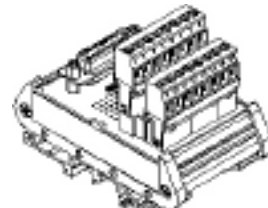

Female D-Sub Connector to Pluggable 5.08mm (.200") Terminal Block

Circuits	Order No.		Dimensions
	Female-D Sub Connector to Fixed Mount 5.08mm (.200") Terminal Block	Female-D Sub Connector to Pluggable 5.08mm (.200") Terminal Block	Length
9	39170-3009	39170-3109	39.40mm (1.550")
15	39170-3015	39170-3115	54.40mm (2.140")
25	39170-3025	39170-3125	79.80mm (3.140")
37	39170-3037	39170-3137	106.40mm (4.190")
50	39170-3050	39170-3150	142.00mm (5.590")

**Americas Headquarters**  
Lisle, Illinois 60532 U.S.A.  
1-800-78MOLEX  
amerinfo@molex.com

**Far East North Headquarters**  
Yamato, Kanagawa, Japan  
81-462-65-2324  
feninfo@molex.com

**Far East South Headquarters**  
Jurong, Singapore  
65-6-268-6868  
fesinfo@molex.com

**European Headquarters**  
Munich, Germany  
49-89-413092-0  
eurinfo@molex.com

**Corporate Headquarters**  
2222 Wellington Ct.  
Lisle, IL 60532 U.S.A.  
630-969-4550  
Fax:630-969-1352

Visit our Web site at <http://www.molex.com/product/tblocks.html>