

描述 / Descriptions

TO-220 塑封封装 N 沟道 MOS 场效应管。N-CHANNEL MOSFET in a TO-220 Plastic Package.

特征 / Features

快速切换, 低导通电阻, 低栅极电荷, 低反向传输电容, 100%单脉冲雪崩能量测试。

Fast Switching, Low ON Resistance, Low Gate Charge, Low Reverse transfer capacitances, 100% Single Pulse avalanche energy Test.

用途 / Applications

用于 UPS 电源, 逆变器, 照明。

For UPS, inverters, lightin.

内部等效电路 / Equivalent Circuit

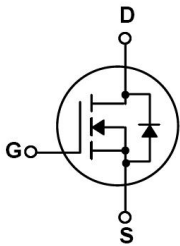

引脚排列 / Pinning

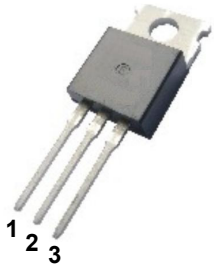

PIN 1 : G

PIN 2 : D

PIN 3 : S

放大及印章代码 / h_{FE} Classifications & Marking

见印章说明。 See Marking Instructions.

极限参数 / Absolute Maximum Ratings(Ta=25°C)

参数 Parameter	符号 Symbol	数值 Rating	单位 Unit
Drain-Source Voltage	V_{DSS}	200	V
Drain Current	I_D	40	A
Gate-Source Voltage	V_{GS}	±20	V
Power Dissipation	$P_D(T_C=25^\circ\text{C})$	250	W
Repetitive Avalanche Energy	E_{AS}^{a1}	500	mJ
Peak Diode Recovery dv/dt	dv/dt^{a2}	5	V/ns
Junction Temperature Range	T_J	150	°C
Storage Temperature Range	T_{stg}	-55 to 150	°C
Temperature for Soldering	T_L	300	°C
Thermal Resistance Junction- Case	$R_{\theta JC}$	0.65	°C/W
Thermal Resistance Junction- Ambient	$R_{\theta JA}$	62.5	°C/W

电性能参数 / Electrical Characteristics(Ta=25°C)

参数 Parameter	符号 Symbol	测试条件 Test Conditions	最小值 Min	典型值 Typ	最大值 Max	单位 Unit
Drain-Source Breakdown Voltage	V_{DSS}	$V_{GS}=0V$ $I_D=250\mu A$	200			V
Zero Gate Voltage Drain Current	I_{DSS}	$V_{DS}=200V$ $V_{GS}=0V$ $T_a=25^\circ\text{C}$			10	μA
		$V_{DS}=160V$ $V_{GS}=0V$ $T_a=125^\circ\text{C}$			200	
Gate-Body Leakage Current Forward	I_{GSS}	$V_{GS}=\pm 20V$			±100	nA
Static Drain-Source On-Resistance	$R_{DS(on)}$	$V_{GS}=10V$ $I_D=20A$		0.054	0.065	Ω
Gate Threshold Voltage	$V_{GS(th)}$	$V_{DS}=V_{GS}$ $I_D=250\mu A$	2.0		4	V
Forward Transconductance	g_{fs}	$V_{DS}=15V$ $I_D=20A$		65		S
Input Capacitance	C_{iss}	$V_{GS}=0V$ $V_{DS}=25V$ $f=1.0\text{MHz}$		5000		pF
Output Capacitance	C_{oss}			300		
Reverse Transfer Capacitance	C_{rss}			7		
Turn-On Delay Time	$t_{d(on)}$	$I_D=20A$ $V_{DD}=100V$ $V_{GS}=10V$ $R_G=3.9\Omega$		19		ns
Turn-On Rise Time	t_r			30		
Turn-Off Delay Time	$t_{d(off)}$			68		
Turn-Off Fall Time	t_f			25		

电性能参数 / Electrical Characteristics(Ta=25°C)

Total Gate Charge	Q_g	$I_D=20A$ $V_{DD}=100V$ $V_{GS} = 10V$		68		nC
Gate-Source Charge	Q_{gs}			17		
Gate-Drain Charge	Q_{gd}			16		
Continuous Source Current	I_S				40	A
Maximum Pulsed Current	I_{SM}				160	A
Diode Forward Voltage	V_{SD}	$I_S=40A$ $V_{GS}=0V$			1.5	V
Reverse Recovery Time	t_{rr}	$I_S=20A$ $T_j=25^\circ C$ $d_{IF}/d_t=100A/us, V_{GS}=0V$		250		ns
Reverse Recovery Charge	Q_{rr}			1.5		μC

Notes:

a1: L=1.0mH, $I_D=31.6A$, Start $T_J=25^\circ C$

a2: $I_{SD} = 10A, di/dt \leq 100A/us, V_{DD} \leq B_{VDS}$, Start $T_J=25^\circ C$

电参数曲线图 / Electrical Characteristic Curve

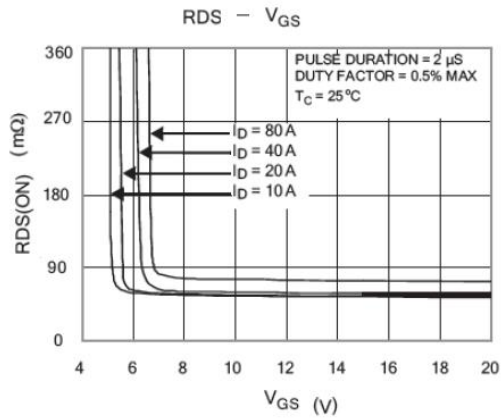
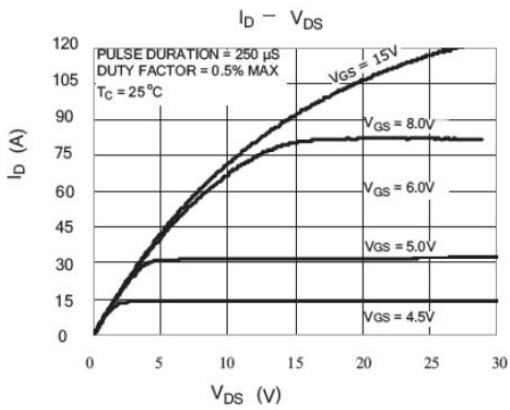
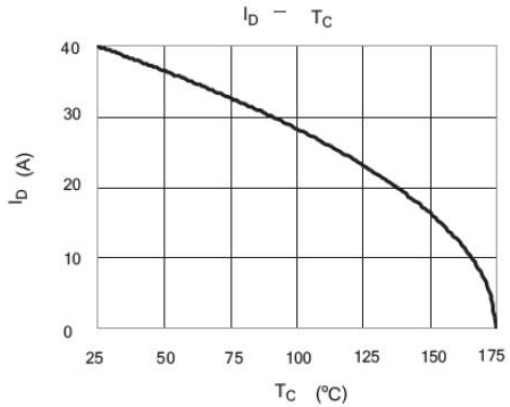
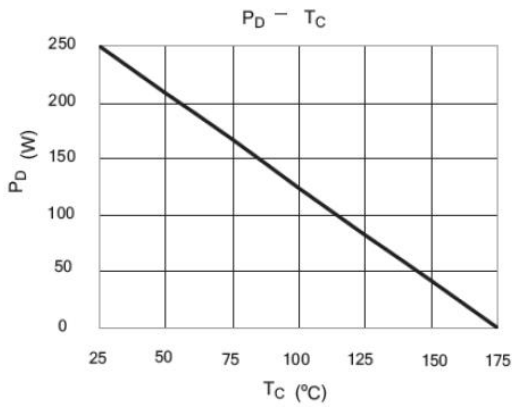
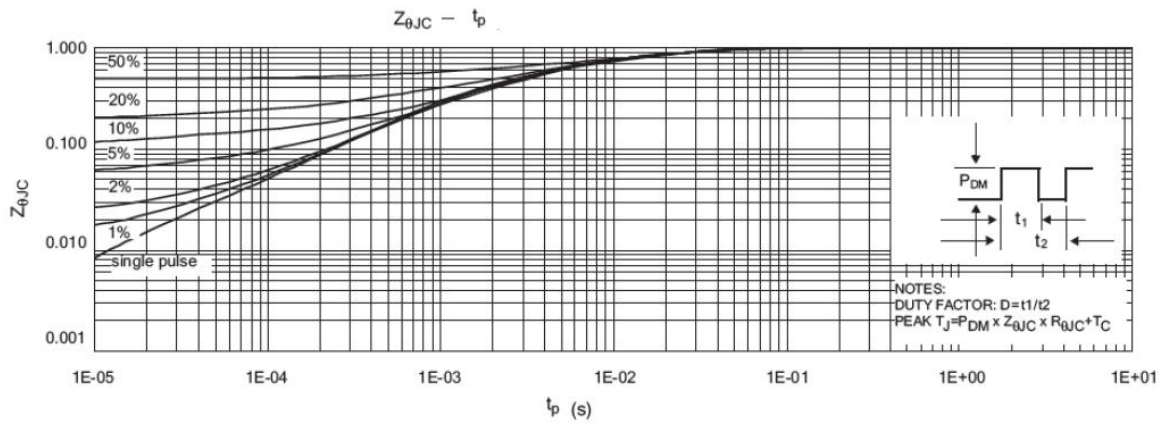

电参数曲线图 / Electrical Characteristic Curve

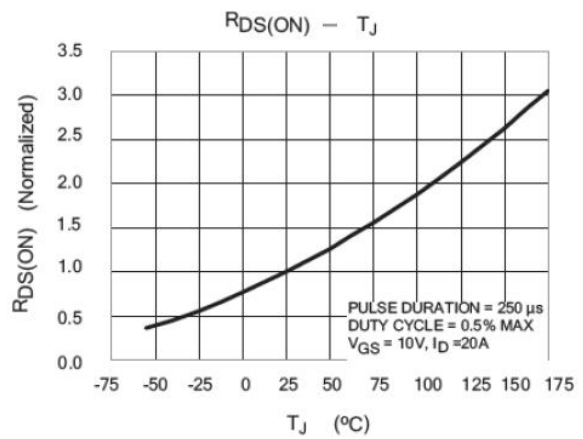
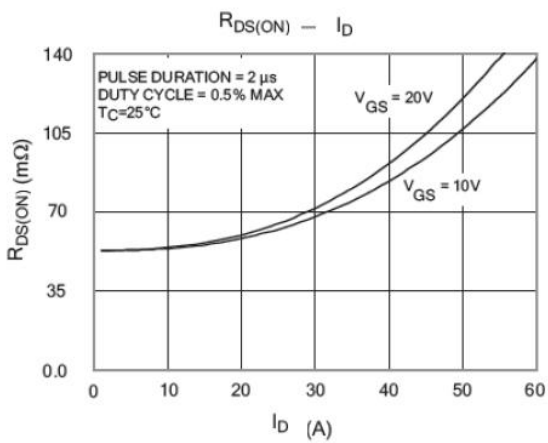
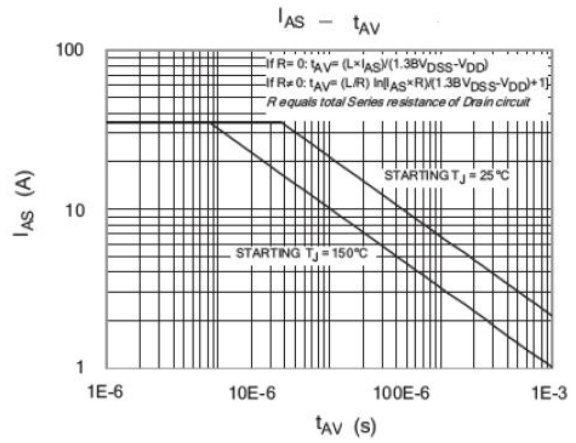
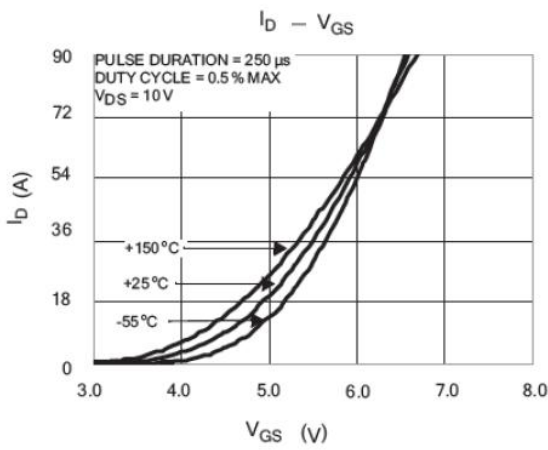
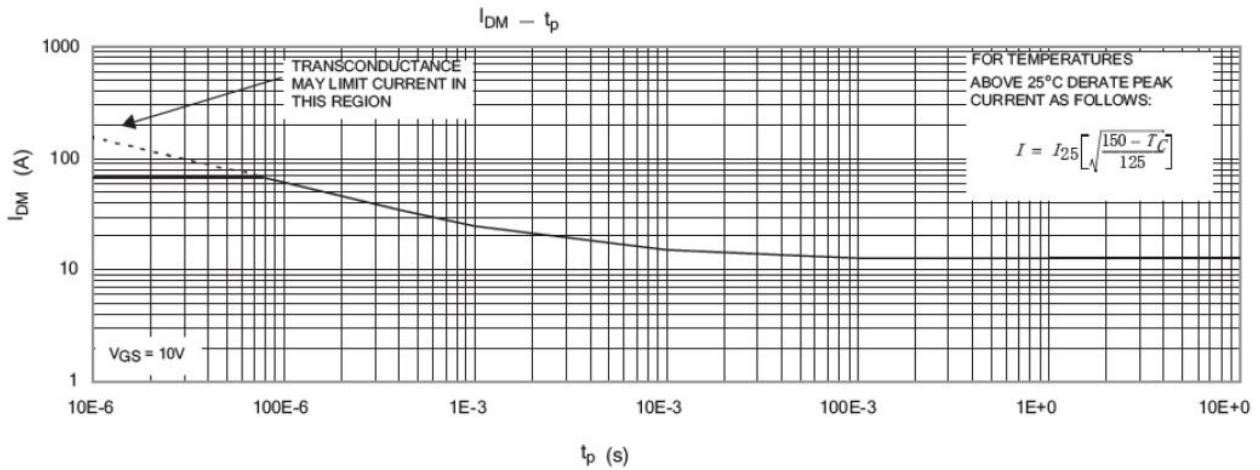

电参数曲线图 / Electrical Characteristic Curve

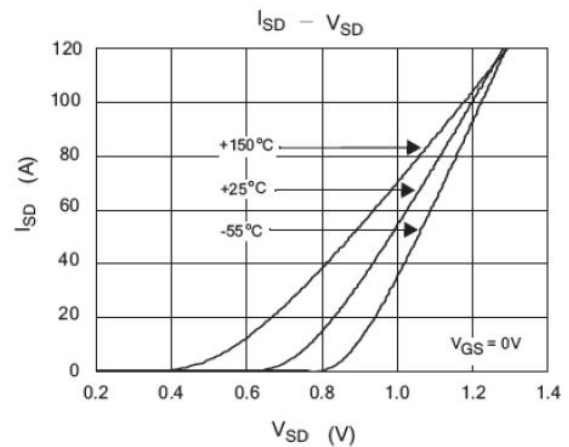
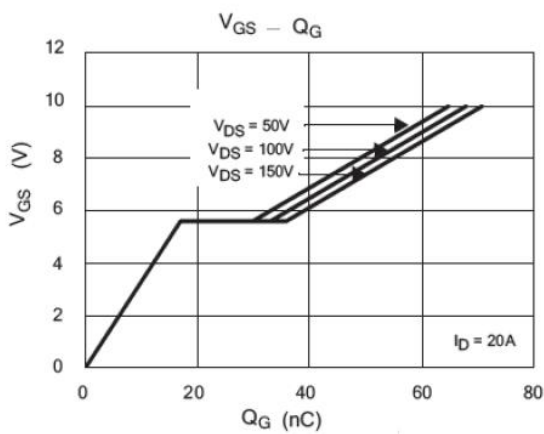
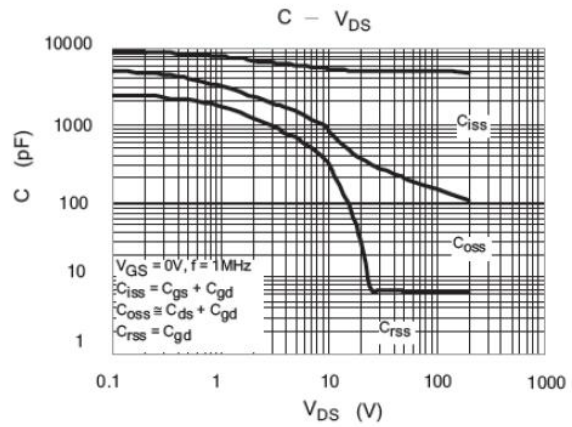
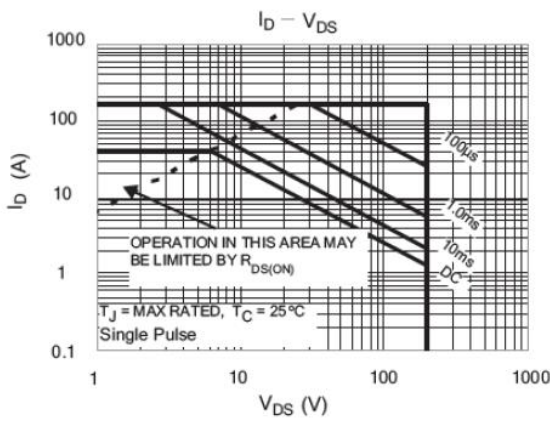
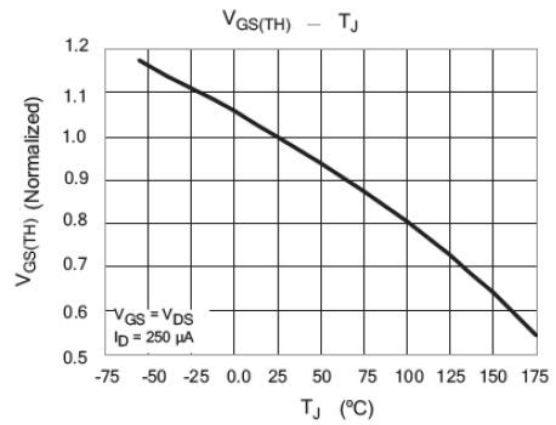
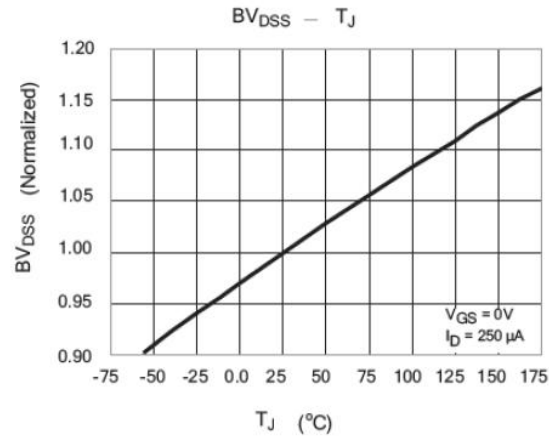

外形尺寸图 / Package Dimensions

TO-220

单位: mm

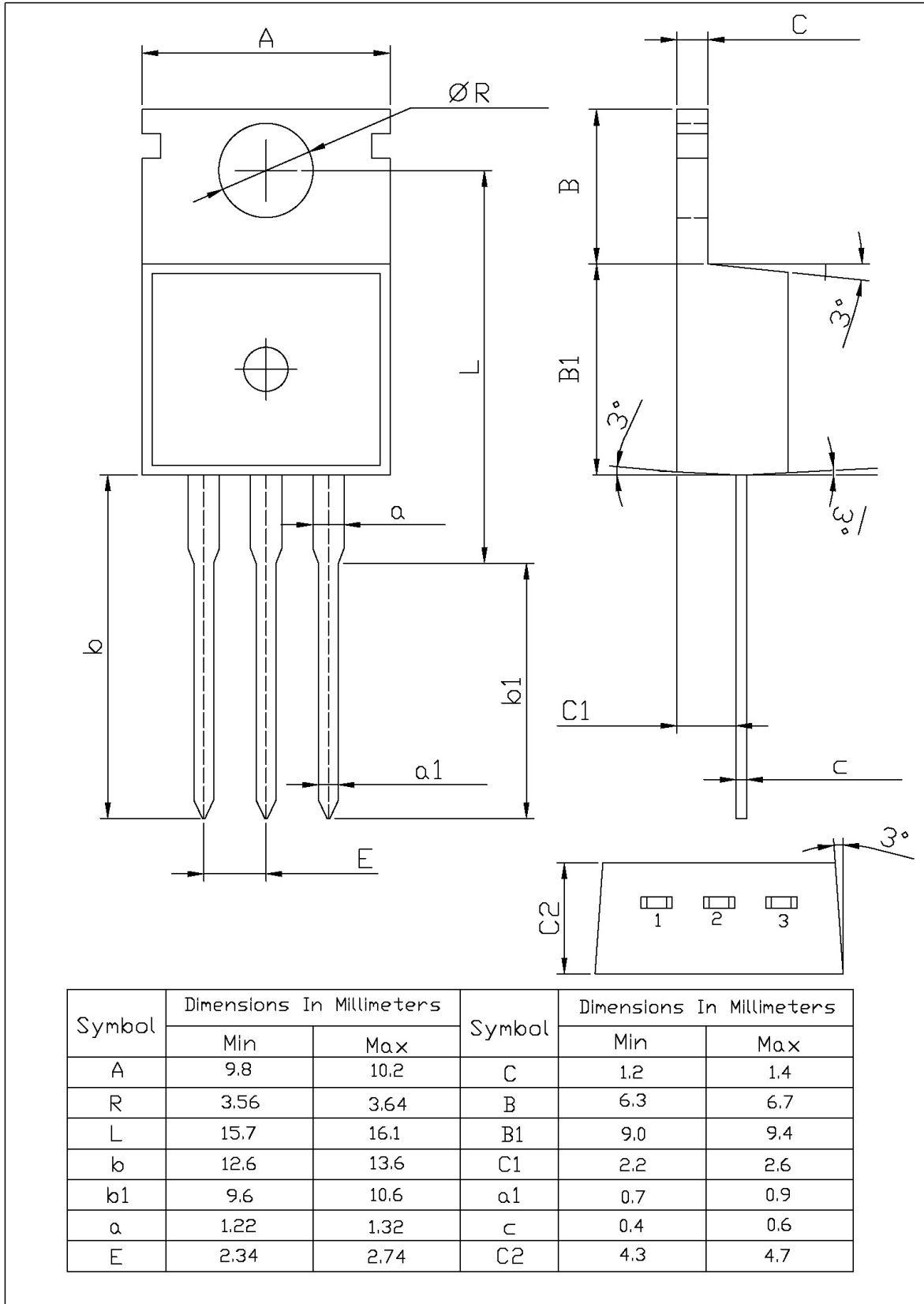

印章说明 / Marking Instructions

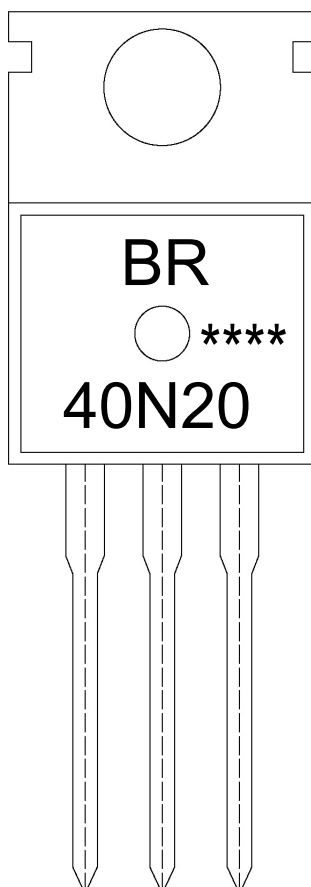

说明：

BR： 为公司代码

40N20： 为型号代码

****： 为生产批号代码，随生产批号变化。

Note:

BR: Company Code

40N20: Product Type.

****: Lot No. Code, code change with Lot No.

波峰焊温度曲线图(无铅) / Temperature Profile for Dip Soldering(Pb-Free)

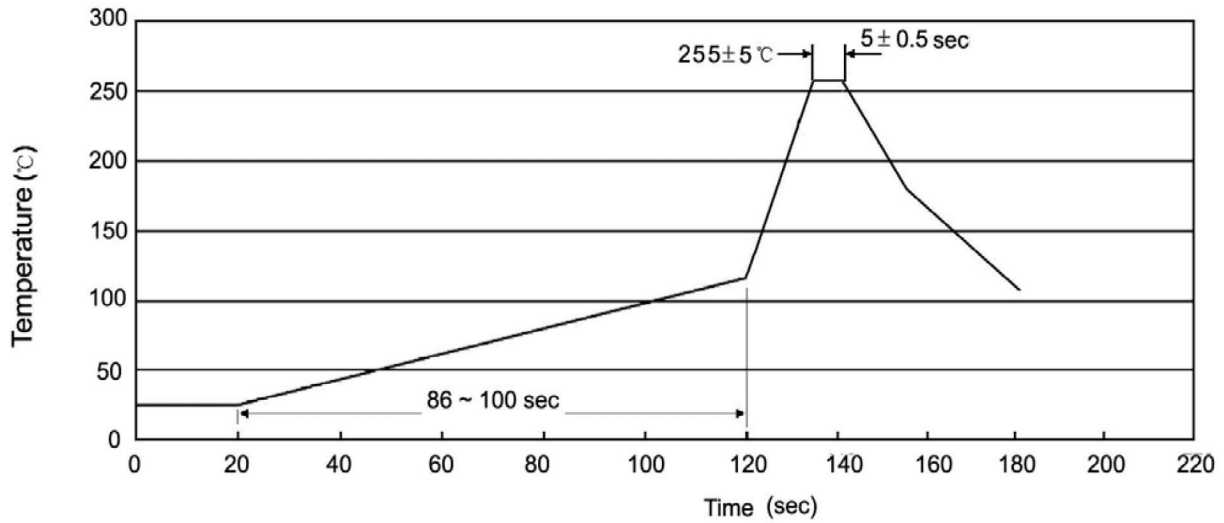

说明：

- 1、预热温度 25 ~ 150°C，时间 60 ~ 90sec;
- 2、峰值温度 255±5°C，时间持续为 5±0.5sec;
- 3、焊接制程冷却速度为 2 ~ 10°C/sec.

Note:

- 1.Preheating:25~150°C, Time:60~90sec.
- 2.Peak Temp.:255±5°C, Duration:5±0.5sec.
3. Cooling Speed: 2~10°C/sec.

耐焊接热试验条件 / Resistance to Soldering Heat Test Conditions

温度：270±5°C

时间：10±1 sec.

Temp.:270±5°C

Time:10±1 sec

包装规格 / Packaging SPEC.

散件包装 / BULK

Package Type 封装形式	Units 包装数量					Dimension 包装尺寸 (unit: mm ³)		
	Units/Bag 只/袋	Bags/Inner Box 袋/盒	Units/Inner Box 只/盒	Inner Boxes/Outer Box 盒/箱	Units/Outer Box 只/箱	Bag 袋	Inner Box 盒	Outer Box 箱
TO-220/F	200	10	2,000	5	10,000	135×190	237×172×102	560×245×195

套管包装 / TUBE

Package Type 封装形式	Units 包装数量					Dimension 包装尺寸 (unit: mm ³)		
	Units/Tube 只/套管	Tubes/Inner Box 套管/盒	Units/Inner Box 只/盒	Inner Boxes/Outer Box 盒/箱	Units/Outer Box 只/箱	Tube 套管	Inner Box 盒	Outer Box 箱
TO-220/F	50	20	1,000	5	5,000	532×31.4×5.5	555×164×50	575×290×180

使用说明 / Notices